

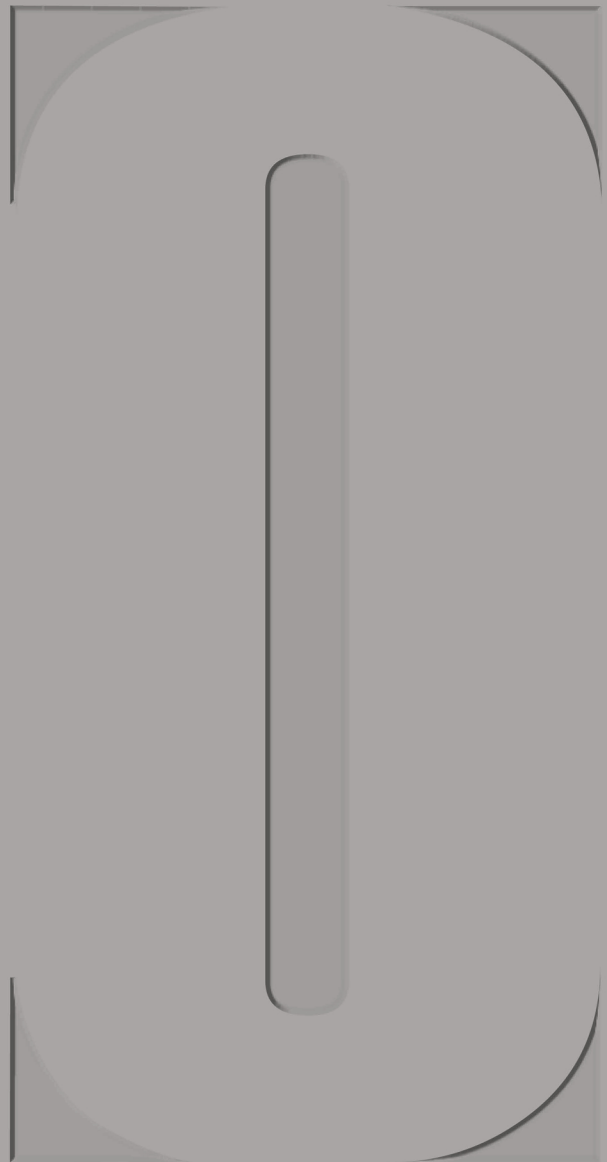

CATALOGO GENERALE
GENERAL CATALOGUE

22

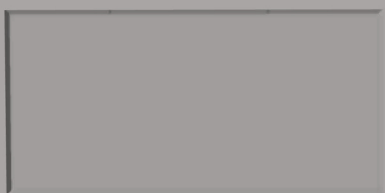

CATALOGO GENERALE - GENERAL CATALOGUE



DA 40 ANNI, SIAMO SINONIMO DI
PROFESSIONALITA', ETICA E AFFIDABILITA'
METTENDO SEMPRE IL CLIENTE AL CENTRO DEL
PROGETTO DI CRESCITA, COME PARTE INTEGRANTE
E VERO MOTORE DELL'AZIENDA STESSA.

QUESTE CARATTERISTICHE, SONO DIVENTATE I
NOSTRI PRINCIPALI STRUMENTI CHE CI HANNO
CONTRADDISTINTO E RICONOSCIUTO NEL SETTORE
DELL'ILLUMINAZIONE COME AZIENDA LEADER.

FOR 40 YEARS, WE HAVE BEEN SYNONYMOUS WITH
PROFESSIONALISM, ETHICS AND RELIABILITY
ALWAYS PUTTING THE CUSTOMER AT THE CENTER
OF THE GROWTH , AS AN INTEGRAL PART AND REAL
MOTOR OF THE COMPANY ITSELF.

THESE FEATURES HAVE BECOME OUR MAIN TOOLS
THAT HAVE DISTINCTED AND RECOGNIZED US IN THE
LIGHTING SECTOR AS A LEADING COMPANY.

INTERNI – INDOOR

INCASSI
RECESSED  19

PROIETTORI E BINARI ELETRIFICATI
SPOTLIGHTS AND TRACKS  133

PARETE - PLAFONE - SOSPENSIONE
WALL - CEILING - SUSPENSION  193

SISTEMI
SYSTEMS  295

FOODLIGHTING  339

ESTERNI – OUTDOOR

INCASSI A TERRA
INGROUND  377

INCASSI A SOFFITTO
CEILING RECESSED  447

INCASSI A PARETE - SEGNAPASSO
WALL RECESSED - STEP LIGHT  481

PARETE - PLAFONE - SOSPENSIONE
WALL - CEILING - SUSPENSION  503

PROIETTORI DIFFONDENTI - LINEARI - SPOT
FLOODLIGHTING - LINEAR - SPOT PROJECTORS  557

EFFETTI LUMINOSI
LIGHT EFFECTS  595

IMMERSIONE
UNDERWATER  609

RESIDENZIALE URBANO - BOLLARDS
URBAN & RESIDENTIAL LUMINAIRES - BOLLARDS  629

INTERNI - INDOOR

ESTERNI - OUTDOOR

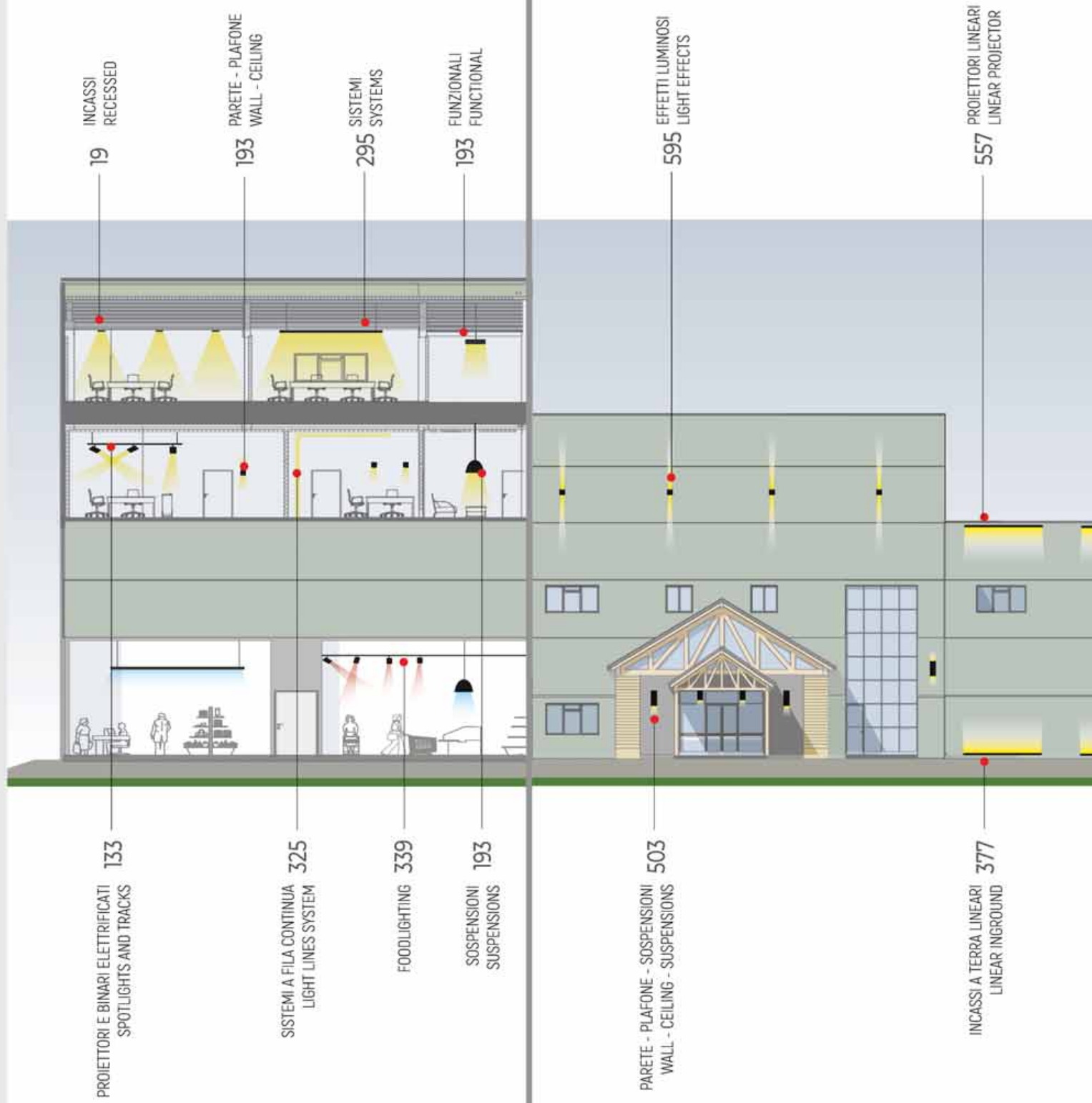

19
INCASSI
RECESSED

193
PARETE - PLAFONE
WALL - CEILING

295
SISTEMI
SYSTEMS

193
FUNZIONALI
FUNCTIONAL

133
PROIETTORI E BINARI ELETTIFICATI
SPOTLIGHTS AND TRACKS

325
SISTEMI A FILA CONTINUA
LIGHT LINES SYSTEM

339
FOODLIGHTING

193
SOSPENSIONI
SUSPENSIONS

595
EFFETTI LUMINOSI
LIGHT EFFECTS

503
PARETE - PLAFONE - SOSPENSIONI
WALL - CEILING - SUSPENSIONS

557
PROIETTORI LINEARI
LINEAR PROJECTOR

377
INCASSI A TERRA LINEARI
LINEAR INGROUND



INCASSI A TERRA CALPESTABILI
WALKABLE INGROUND 377

INCASSI A SOFFITTO
CEILING RECESSED 447

SEGNALAZIONE
SIGNAL 439

SEGNAPASSO
STEP LIGHT 481

RESIDENZIALE URBANO
URBAN & RESIDENTIAL LUMINAIRES 629

BOLLARDS 629

INCASSI A TERRA CARRABILI
DRIVE OVER INGROUND 377

PROIETTORI
PROJECTORS 557

IMMERSIONE
UNDERWATER 609

**INCASSI
RECESSED**
MICRO SPOT EFFETTI DI LUCE – LIGHT EFFECTS

DOT
20

SHELF LED
25

LUCE D'ACCENTO – ACCENT DOWNLIGHTERS
RETROFIT

BBTT
27

JOCKER
29

JOLLY
35

COMFORT

FOCUS
36

CO-LIGHT
41

PERFORMANCE

SWING
47

NET MCL
53

BEND INCASSO
61

TOR
69

SPRINT
73

NEW

STILO 28 INCASSO
75

LUCE DIFFUSA – FLOODLIGHTING
SEZIONE TONDA - ROUND SECTION

RULED TONDO
79

TWIST
85

STEP
86

NET BLOCK
89

NET SC
95

BIG INCASSO
97

SEZIONE QUADRA - SQUARE SECTION

RULED QUADRO
100

SINDI
102

DOMINO
107

RANDY 2
111

L18
113

NEW

ROSS INCASSO
115

MULTI OTTICA – MULTIPLE OPTICS

TRAIL INCASSO
117

MATRIX MICRO
119

MATRIX MINI
122

MATRIX
127

MATRIX POWER
130

 **PROIETTORI E BINARI ELETRIFICATI**
SPOT AND TRACK LIGHTS

• **LUCE CONCENTRANTE – SPOT LIGHTING**

PERFORMANCE



BEND SLIM
135

NEW



BEND XS 2019
141



LUXOR
143



SIRIUS MCL
147

COMFORT



SHORT
149

NEW



SHORT ZOOM
153

NEW



STILO
155



VEGA BINARIO
161

• **LUCE DIFFUSA – FLOODLIGHTING**

PERFORMANCE



BIG BINARIO
163



SOLARIS BINARIO
164

NEW



ROSS BINARIO
167

• **MAGNET.G2 SYSTEM 48V**



**MAGNET.G2
BINARIO**
170



**MAGNET.G2
LINEARI**
174



**MAGNET.G2
SPOT**
176



**MAGNET.G2
DROP**
177

• **BINARI ELETRIFICATI – ELECTRIFIED TRACK**



BINARIO
179

• **PLAFONE – CEILING**



BEND MICRO
189



BEND MINI
191

PARETE - PLAFONE - SOSPENSIONE
WALL - CEILING - SUSPENSION
• DECO-TECH

SINDI PLAFONE
195

CUBIK
198

MATRIX RANGE
205

DROP
206

SWING PLAFONE
214

NET RANGE MCL
216

VEGA PARETE
219

SOLARIS
221

BIG PLAFONE
228

BIG SOSPENSIONE
234

BIG FLAT PLAFONE
243

BIG FLAT SOSPENSIONE
247

STARGATE
251

STARGATE 2000/3000
258

AURORA XS
261

AURORA XL
263

QUADRANT
265

• FUNZIONALI – FUNCTIONAL

MINI TOWER MCL
266

NET RANGE 15 MCL
268

NET RANGE 18 MCL
270

ROSS PARETE
273

ROSS SOSPENSIONE
275

SD-HIGHBAY
277

• LINEARI – LINEAR

ELISEO PARETE
279

ELISEO SOSPENSIONE
280

SLIM LED
283

TAPE
285

STRIP LED
290

**SISTEMI
SYSTEMS**
FILE CONTINUE - LIGHT LINES

LINEA
296



TRAIL
PLAFONE
299



TRAIL
SOSPENSIONE
303



LINEAR SYSTEM
INCASSO
307



LINEAR SYSTEM
PARETE/PLAFONE
307



LINEAR SYSTEM
SOSPENSIONE
307



NEW
LIGHT CUT
325

FOODLIGHTING

INCASSI – RECESSED

NET BLOCK
FOOD
341



NET MCL
FOOD
344



TOR 15 MCL
ORIENTABILE FOOD
349



MATRIX MCL
FOOD PLUS
351

PROIETTORI E BINARI ELETTIFICATI – SPOT AND TRACK LIGHTS

BEND XS 2019
FOOD
353



BEND SLIM
FOOD
354



SIRIUS MCL
FOOD PLUS
356



LUXOR XL
FOOD PLUS
357

SOSPENSIONI – SUSPENSIONS

UFO 2 MCL
FOOD
359



MINI TOWER
MCL FOOD
360



AURORA XS
FOOD
363



AURORA XL
FOOD PLUS
365

A RICHIESTA – ON REQUEST

NEW
ROSS
INCASSO
369



NEW
ROSS
BINARIO
371



NEW
ROSS
PARETE
372



NEW
ROSS
SOSPENSIONE
373



LINEA
374

**INCASSI A TERRA
INGROUND**
• CALPESTABILI/CARRABILI - WALK/DRIVE OVER

EYES GROUND

379



CIELO FLOOR

381

OLODUM MICRO
TONDO

383

OLODUM MICRO
QUADRO

387

OLODUM MINI
TONDO

389

OLODUM MINI
QUADRO

392

OLODUM MIDI
TONDO

394

OLODUM MIDI
QUADRO

397

OLODUM
STANDARD
TONDO

403

OLODUM
STANDARD
TONDO PROOF

407

OLODUM
STANDARD
QUADRO

408

OLODUM
STANDARD
QUADRO PROOF

409

OLODUM
MAXI

410

NEWOLODUM RULED
MIDI

412

NEWOLODUM RULED
MIDI QUADRO

413

NEWOLODUM RULED
STANDARD

414

NEWOLODUM RULED
STANDARD QUADRO

415

NEWOLODUM RULED
MAXI

416

NEWOLODUM RULED
MAXI QUADRO

417

LOCKsystem**NEW**OLODUM RULED
MIDI PROOF

419

LOCKsystem**NEW**OLODUM RULED
STANDARD PROOF

421

LOCKsystem**NEW**OLODUM
STANDARD PROOF

423

OLODUM MINI
FULL GLASS

425

OLODUM MIDI
FULL GLASS

427

• LINEARI - LINEAR

MINI LONGLIGHT

429



LONGLIGHT

431



LONGLIGHT SMD

433



LONGLIGHT ECO

435

LONGLIGHT ECO
ASIMMETRICO

437

• SEGNALAZIONE - STEP LIGHT

EYES COVER

439

OLODUM MICRO
COVER

440

OLODUM MICRO
PASS

440

OLODUM MICRO
COVER AL

441

OLODUM MINI
COVER AL

443

OLODUM STANDARD
COVER

445



INCASSI A SOFFITTO
CEILING RECESSED
MICRO SPOT – EFFETTI LUCE - LIGHT EFFECTS

EYES PRO

448

EYES PRO M
TONDO

449

EYES PRO M
QUADRO

449



EYES BASIC A

451



EYES BASIC B

453

EYES A-1
TONDO

457

EYES A-1
QUADRO

457

EYES B-1
TONDO

459

EYES B-1
QUADRO

459

EYES WALL
FLAT COB TONDO

463

EYES WALL
FLAT COB QUADRO

463



EYES C

465



EYES ORIENTABILE

467

DOWNLIGHTERS

CIELO 3 LED

468



CIELO COB

469

OLODUM MICRO C
TONDO

471

OLODUM MICRO C
QUADRO

471

OLODUM MINI C
TONDO

473

OLODUM MIDI C
TONDO

475

OLODUM STANDARD C
TONDO

477

INCASSI A PARETE - SEGNAPASSO
WALL RECESSED - STEP LIGHT
SEGNAPASSO – STEP LIGHT
EYES
CORRIMANO

483



EYES WALL

485



RING

487

OLODUM MINI
PARETE

489

RIQUADRO
MICRO LED

491

RIQUADRO
MICRO LED

493



NEW GREEN

494



JOGGER

499



APPLY MINI

500



APPLY 1-2

501

ESTERNI – OUTDOOR

PARETE – PLAFONE – SOSPENSIONE
WALL – CEILING – SUSPENSION

**ELLE PARETE
XS**
505

**ELLE PARETE
XL**
505

MINI TONDO
507

MINI QUADRO
508

**MONOLIGHT
105**
510

**MONOLIGHT
140**
511

**MONOLIGHT
175**
513

**DOUBLELIGHT
105**
515

**DOUBLELIGHT
140**
516

**DOUBLELIGHT
175**
517

QUADRO
519

**MICRO
VARIANT**
522

**MINI
VARIANT**
523

QUADERS
525

**NEW QUARTO
DI SFERA**
527

MOON
529

CERKIO XS-XL
530

FENIX
533

SOLID
535

**MINI MISTRAL
LED**
537

MISTRAL LED
539

**QUADRO
CEILING**
541

**CEILING
105**
543

**CEILING
140**
544

**CEILING
175**
545

**CEILING S
105**
547

CEILING S 140
548

CEILING S 175
549

SOLARIS
552



PROIETTORI DIFFONDENTI – LINEARI – SPOT
FLOODLIGHTING – LINEAR – SPOT PROJECTORS
• DIFFONDENTI – FLOODLIGHTING

AZIMUTH

559



DUNE

561



SD-HIGHBAY

563

• LINEARI – LINEAR
MINI LONGLIGHT
ST

564

LONGLIGHT
ST

565

LONGLIGHT
WALL

567

LONGLIGHT
ECO ST

568

LONGLIGHT
ECO WALL

569



NEW ACTIVA

571



FIN

573

MICRO LEDLINE
TONDO

575

MINI LEDLINE
TONDO

577

• SPOT

SPOT 4

579



SPOT 7

581



SPOT MCL

581

NEW

SPOT

583



MICRO REEF

589



MINI REEF

591



REEF

593

ESTERNI – OUTDOOR

**EFFETTI LUMINOSI
LIGHT EFFECTS**

SMALL-BLADE
ROUND
596



SMALL-BLADE
SQUARE
597



SMALL-BLADE
SQUARE LONG
599



NEOST
600



NEOS Q
602



LI-LED
605



LI-LED ST
607

**IMMERSIONE
UNDERWATER**

MINI SUB
610



MINI TKF/TKT
614



PAR 56
617



SUBMARINER
620



SUBWATER
625

**RESIDENZIALE URBANO – BOLLARDS
URBAN & RESIDENTIAL LUMINAIRES – BOLLARDS**
PALI – POST

TESTA PALO
SINGOLO
630



TESTA PALO
DOPPIO
631



ATTACCO PALO
632



ATTACCO PALO
DOPPIO
633



PALO QUADRO
635

BOLLARDS

LITTLE ROK
637



ROK
639



Q8
641



VERSO
643



FRISBEE
647



FRISBEE MAXI
649



ELLE
651

ALIMENTATORI - ACCESSORI DRIVERS - ACCESSORIES

- 656 ALIMENTATORI
DRIVERS
- 662 KIT ALIMENTATORI-MISCELATORI RGB
MIXER KITS-RGB DRIVERS
- 668 ACCESSORI
ACCESSORIES

DATI TECNICI TECHNICAL DATA

- 671 GRADO DI PROTEZIONE
PROTECTION DEGREE
- 672 AGENTI CORROSIVI
CORROSIVE AGENTS
- 674 SIMBOLOGIA
SYMBOLY
- 676 CERTIFICAZIONI
CERTIFICATIONS
- 678 FINITURE
FINISHING
- 680 RETE VENDITA ITALIA
- 682 CONDIZIONI GENERALI DI VENDITA - ITALIA
- 684 INDICE CODICE PRODOTTI
PRODUCTS CODE INDEX



TIPOLOGIA DI INSTALLAZIONE
TYPE OF INSTALLATION

- Corpo in pressofusione di alluminio verniciato
- Verniciatura in polveri di poliestere
- Adattatore elettrico trifase con driver per montaggio a binario
- Vetro di protezione
- Riflettore in alluminio purissimo, metallizzato in alto vuoto
- Led durata utile: 50.000 (h) L90 B20
- Costanza cromatica: 5 SDCM
- Body made in die-cast aluminum painted
- Polyester powder painting
- Three-phase electric adapter with integrated driver for rail mounting
- Protection glass
- Pure aluminum reflector, high vacuum metallized
- Led service life: 50,000 (h) L90 B20
- Chromatic constance: 5 SDCM

INFORMAZIONI DI PRODOTTO
PRODUCT INFORMATION

LUCE CONCENTRANTE - SPOT LIGHTING PERFORMANCE

BEND XS 2019

NOME PRODOTTO
PRODUCT NAME



POTENZA
POWER

POTENZA SISTEMA
SYSTEM POWER

	IP	RG0	RG1	RG2	RG3	RG4	W	lm	V	K	RA	W	lm	W	lm	€
Tr	67308-LBC-15	67309-LBC-25	67310-LBC-40	67311-LBC-60								3476	81	1071		
Tr	67308-LBC-15	67309-LBC-25	67309-LBC-40	67309-LBC-60	300	3000	220-240V	3000	400	400	3000	3370	81	1071	64,30	
Tr	67310-LBC-15	67310-LBC-25	67310-LBC-40	67310-LBC-60								2674	25	1407		
Tr	67310-LBC-15	67310-LBC-25	67310-LBC-40	67310-LBC-60								2128	81	1071		
Tr	67309-LBN-15	67309-LBN-25	67309-LBN-40	67309-LBN-60								5790	81	1071		
Tr	67309-LBN-15	67309-LBN-25	67309-LBN-40	67309-LBN-60	300	3000	220-240V	3000	400	400	3000	3830	304	1207	64,30	
Tr	67310-LBN-15	67310-LBN-25	67310-LBN-40	67310-LBN-60								5207	81	1407		
Tr	67310-LBN-15	67310-LBN-25	67310-LBN-40	67310-LBN-60								3353	81	1071		

SIMBOLOGIA (VEDI LEGENDA)
SYMBOLGY (SEE LEGEND)



OPZIONI E ACCESSORI
OPTIONS AND ACCESSORIES

SIMBOLOGIA (VEDI LEGENDA)
SYMBOLGY (SEE LEGEND)

DIAGRAMMA CONICO
CONIC DIAGRAM

FASCIO LUMINOSO
LIGHT BEAM

INSTALLAZIONE
INSTALLATION

* In fase di approvazione - Under approval

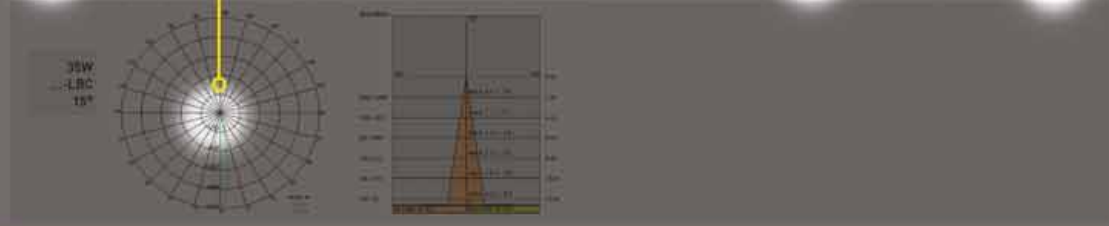

ALUMINATORE (4) RG0 (se non in dotazione) da ordinare dalla sezione servizio - DRIVER RGB (RTS) (se non supportato) to be ordered from the service section

WWW.SIDESP.A.IT



ANELLI DI COMPENSAZIONE

Mettiamo a disposizione 6 anelli di compensazione di colore bianco, utilizzabili dai nostri apparecchi illuminanti a incasso in versione standard.

Questa gamma permette all'installatore di poter proporre soluzioni veloci e meno invasive senza costi aggiuntivi di ristrutturazione per la committenza.

SIDE può creare su richiesta anelli personalizzati di ogni dimensione e con ogni colorazione RAL per sostituire gli impianti illuminotecnici anche della concorrenza. SIDE, oltre all'anello di compensazione modificherà la lunghezza delle molle di fissaggio per singolo faretto per garantire la massima sicurezza installativa.

COMPENSATION RINGS

A range of 6 compensation rings in white color is available to adapt our ceiling recessed products to holes of various diameters.

This range allows the installer to propose different and fast solutions, less invasive and without additional costs for the customer.

SIDE can create on request, customized rings of any size and RAL color in order to cover the most demanding requirements. Beside the compensation ring, SIDE will also modify the length of the fixing springs of every single spotlight, to ensure the maximum safety of installation.

<p>codice code 116</p>  <p>FORO ESISTENTE EXISTING HOLE max \varnothing 140 mm</p> <p>IN \varnothing 75 mm OUT \varnothing 150 mm</p>	 <p>JOCKER COB</p>	 <p>JOCKER EMME</p>			
<p>codice code 117</p>  <p>FORO ESISTENTE EXISTING HOLE max \varnothing 150 mm</p> <p>IN \varnothing 80 mm OUT \varnothing 160 mm</p>	 <p>JOCKER COB ORIENTABILE</p>	 <p>JOCKER 3 LED ORIENTABILE</p>	 <p>JOCKER EMME ORIENTABILE</p>	 <p>JOLLY</p>	
<p>codice code 122</p>  <p>FORO ESISTENTE EXISTING HOLE max \varnothing 190 mm</p> <p>IN \varnothing 156 mm OUT \varnothing 210 mm</p>	 <p>NET 15 BLOCK</p>	 <p>NET 15 NEW BASIC</p>	 <p>TOR 15 MCL ORIENTABILE</p>	 <p>NET MCL</p>	 <p>STEP 15</p>
<p>codice code 125</p>  <p>FORO ESISTENTE EXISTING HOLE max \varnothing 235 mm</p> <p>IN \varnothing 205 mm OUT \varnothing 255 mm</p>	 <p>NET 18 BLOCK</p>	 <p>NET 18 NEW BASIC</p>	 <p>STEP 18</p>		
<p>codice code 126</p>  <p>FORO ESISTENTE EXISTING HOLE max \varnothing 250 mm</p> <p>IN \varnothing 205 mm OUT \varnothing 270 mm</p>	 <p>STEP 18</p>	<p>N.B. IL PRODOTTO STANDARD UTILIZZA STAFFE E MOLLE ESISTENTI N.B. THE STANDARD PRODUCT USES EXISTING BRACKETS AND SPRINGS</p>			

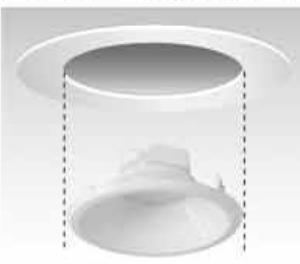
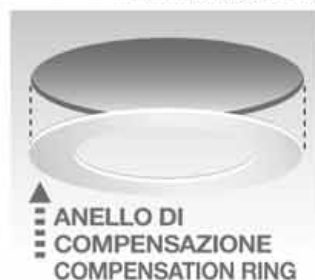

INCASSI
RECESSED

inside

MICRO SPOT EFFETTI DI LUCE – LIGHT EFFECTS

DOT
20SHELF LED
25

LUCE D'ACCENTO – ACCENT DOWNLIGHTERS

RETROFIT

BBTT
27JOCKER
29JOLLY
35

COMFORT

FOCUS
36CO-LIGHT
41

PERFORMANCE

SWING
47NET MCL
53BEND INCASSO
61TOR
69SPRINT
73

NEW

STILO 28 INCASSO
75

LUCE DIFFUSA – FLOODLIGHTING

SEZIONE TONDA - ROUND SECTION

RULED TONDO
79TWIST
85STEP
86NET BLOCK
89NET SC
95BIG INCASSO
97

SEZIONE QUADRA - SQUARE SECTION

RULED QUADRO
100SINDI
102DOMINO
107RANDY 2
111L18
113

NEW

ROSS INCASSO
115

MULTI OTTICA – MULTIPLE OPTICS

TRAIL INCASSO
117MATRIX MICRO
119MATRIX MINI
122MATRIX
127MATRIX POWER
130

DOT TONDO 20 - 30

- Corpo in alluminio verniciato.
- Verniciatura in polveri di poliestere.
- Diffusore in PMMA fascio spot e medio.
- Dissipatore in alluminio.
- Durata nominale: 50000 (h) L80 B10.
- Consistenza cromatica: 3 SDCM.
- Fissaggio a controsoffitto con molle.
- Codici KIT solo per controsoffitti accessibili.
- Aluminium painted body.
- Polyester powder coating
- PMMA diffuser spot and medium beam.
- Aluminium heatsink.
- Led life: 50000 (h) L80 B10.
- Chromatic consistency: 3 SDCM.
- Fixing to false-ceiling with springs.
- KIT codes only for accessible ceilings.



DOT TONDO 20				W	lm	V	K	CRI
Bi	1224-LBC	1226-LBC		1,2W	90	350mA	3000	>90
Ne	1225-LBC	1227-LBC						
Bi	1224-LBN	1226-LBN		1,2W	100	350mA	4000	>90
Ne	1225-LBN	1227-LBN						

ALIMENTATORI CONSIGLIATI - RECOMMENDED DRIVERS

644758	ON-OFF	8W	IP20	350mA
644759-1	ON-OFF	15W	IP20	350mA

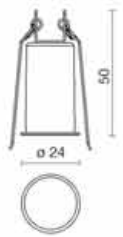

KIT		4 APPARECCHI + ALIMENTATORE - 4 FITTINGS + DRIVER		W	lm	V	K	CRI
Bi	KT1224-LBC-4	KT1226-LBC-4		4x 1,2W	90	220-240V [350mA]	3000	>90
Ne	KT1225-LBC-4	KT1227-LBC-4						
Bi	KT1224-LBN-4	KT1226-LBN-4		4x 1,2W	100	220-240V [350mA]	4000	>90
Ne	KT1225-LBN-4	KT1227-LBN-4						

KIT		12 APPARECCHI + ALIMENTATORE - 12 FITTINGS + DRIVER		W	lm	V	K	CRI
Bi	KT1224-LBC-12	KT1226-LBC-12		12x 1,2W	90	220-240V [350mA]	3000	>90
Ne	KT1225-LBC-12	KT1227-LBC-12						
Bi	KT1224-LBN-12	KT1226-LBN-12		12x 1,2W	100	220-240V [350mA]	4000	>90
Ne	KT1225-LBN-12	KT1227-LBN-12						

DOT TONDO 30				W	lm	V	K	CRI
Bi	1220-LBC	1222-LBC		1,2W	90	350mA	3000	>90
Ne	1221-LBC	1223-LBC						
Bi	1220-LBN	1222-LBN		1,2W	100	350mA	4000	>90
Ne	1221-LBN	1223-LBN						

ALIMENTATORI CONSIGLIATI - RECOMMENDED DRIVERS

644758	ON-OFF	8W	IP20	350mA
644759-1	ON-OFF	15W	IP20	350mA

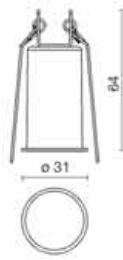

KIT		4 APPARECCHI + ALIMENTATORE - 4 FITTINGS + DRIVER		W	lm	V	K	CRI
Bi	KT1220-LBC-4	KT1222-LBC-4		4x 1,2W	90	220-240V [350mA]	3000	>90
Ne	KT1221-LBC-4	KT1223-LBC-4						
Bi	KT1220-LBN-4	KT1222-LBN-4		4x 1,2W	100	220-240V [350mA]	4000	>90
Ne	KT1221-LBN-4	KT1223-LBN-4						

KIT		12 APPARECCHI + ALIMENTATORE - 12 FITTINGS + DRIVER		W	lm	V	K	CRI
Bi	KT1220-LBC-12	KT1222-LBC-12		12x 1,2W	90	220-240V [350mA]	3000	>90
Ne	KT1221-LBC-12	KT1223-LBC-12						
Bi	KT1220-LBN-12	KT1222-LBN-12		12x 1,2W	100	220-240V [350mA]	4000	>90
Ne	KT1221-LBN-12	KT1223-LBN-12						

OP. A richiesta - On request: disponibile - available

ESEMPIO - EXAMPLE

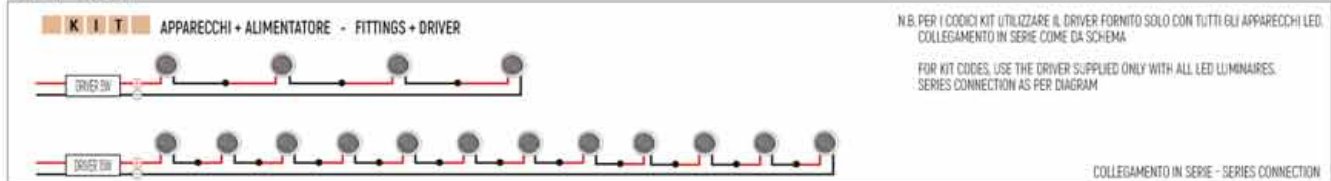

*Solo apparecchio - Only fitting



ALIMENTATORI-KIT RGB (se non in dotazione) da ordinare dalla sezione arancio - DRIVERS-RGB KITS (when not supplied) to be ordered from the section orange color



DOT TONDO 45



- Corpo in alluminio verniciato.
- Verniciatura in polveri di poliestere.
- Diffusore in PMMA fascio spot e medio.
- Dissipatore in alluminio.
- Durata nominale: 50000 (h) L80 B10.
- Consistenza cromatica: 3 SDCM.
- Fissaggio a controsoffitto con molle.
- Codici KIT solo per controsoffitti accessibili.
- Aluminium painted body.
- Polyester powder coating
- PMMA diffuser spot and medium beam.
- Aluminium heatsink.
- Led life: 50000 (h) L80 B10.
- Chromatic consistency: 3 SDCM.
- Fixing to false-ceiling with springs.
- KIT codes only for accessible ceilings.



30 mm Δ 1+30 mm

DOT TONDO 45				W	lm	V	K	CRI
Bi	1228-LBC	1230-LBC		4,2W	540	350mA	3000	>90
Ne	1229-LBC	1231-LBC						
Bi	1228-LBN	1230-LBN		4,2W	600	350mA	4000	>90
Ne	1229-LBN	1231-LBN						

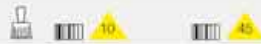
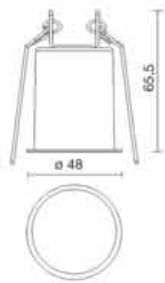

ALIMENTATORI CONSIGLIATI - RECOMMENDED DRIVERS

645906	ON-OFF	20W	IP20	350mA
--------	--------	-----	------	-------

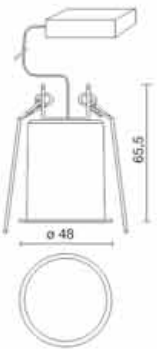

K I T 4 APPARECCHI + ALIMENTATORE - 4 FITTINGS + DRIVER

Bi	KT1228-LBC-4	KT1230-LBC-4	4 x 4W	540	220-240V (350mA)	3000	>90
Ne	KT1229-LBC-4	KT1231-LBC-4					
Bi	KT1228-LBN-4	KT1230-LBN-4	4 x 4W	600	220-240V (350mA)	4000	>90
Ne	KT1229-LBN-4	KT1231-LBN-4					

OP. A richiesta - On request: disponibile - available

ESEMPIO - EXAMPLE

K I T APPARECCHI + ALIMENTATORE - FITTINGS + DRIVER

N.B. PER I CODICI KIT UTILIZZARE IL DRIVER FORNITO SOLO CON TUTTI GLI APPARECCHI LED. COLLEGAMENTO IN SERIE COME DA SCHEMA

FOR KIT CODES, USE THE DRIVER SUPPLIED ONLY WITH ALL LED LUMINAIRES. SERIES CONNECTION AS PER DIAGRAM

COLLEGAMENTO IN SERIE - SERIES CONNECTION

*Solo apparecchio - Only fitting



ALIMENTATORI-KIT RGB (se non in dotazione) da ordinare dalla sezione arancio - DRIVERS-RGB KITS (when not supplied) to be ordered from the section orange color



ESEMPIO - EXAMPLE

K I T APPARECCHI + ALIMENTATORE - FITTINGS + DRIVER

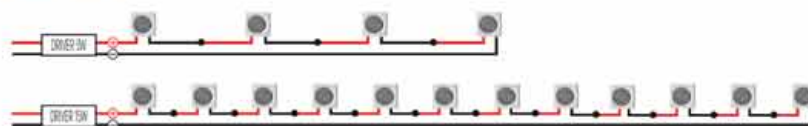

N.B. PER I CODICI KIT UTILIZZARE IL DRIVER FORNITO SOLO CON TUTTI GLI APPARECCHI LED. COLLEGAMENTO IN SERIE COME DA SCHEMA

FOR KIT CODES, USE THE DRIVER SUPPLIED ONLY WITH ALL LED LUMINAIRE. SERIES CONNECTION AS PER DIAGRAM

COLLEGAMENTO IN SERIE - SERIES CONNECTION

*Solo apparecchio - Only fitting

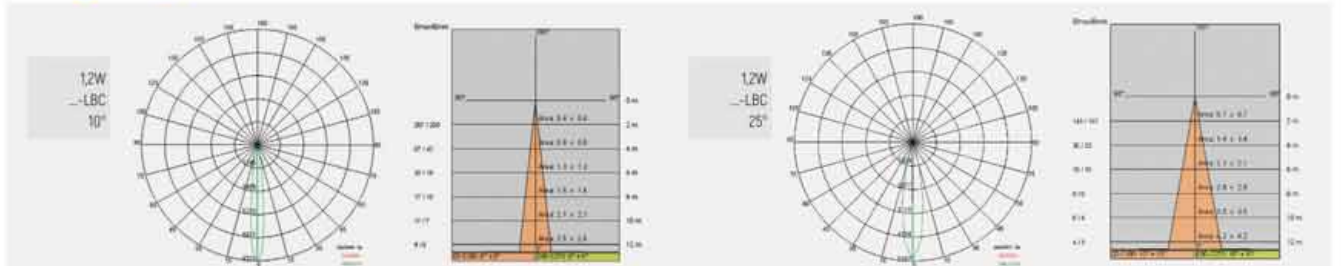
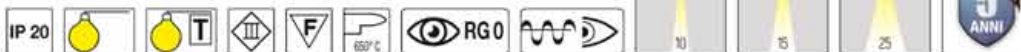

ALIMENTATORI-KIT RGB (se non in dotazione) da ordinare dalla sezione arancio - DRIVERS-RGB KITS (when not supplied) to be ordered from the section orange color



- Corpo in alluminio verniciato.
- Verniciatura in polveri di poliestere.
- Diffusore in PMMA fascio spot e medio.
- Dissipatore in alluminio.
- Durata nominale: 50000 (h) L80 B10.
- Consistenza cromatica: 3 SDCM.
- Fissaggio a controsoffitto con molle.
- Codici KIT solo per controsoffitti accessibili.

- Aluminium painted body.
- Polyester powder coating
- PMMA diffuser spot and medium beam.
- Aluminium heatsink.
- Led life: 50000 (h) L80 B10.
- Chromatic consistency: 3 SDCM.
- Fixing to false-ceiling with springs.
- KIT codes only for accessible ceilings.

DOT QUADRO 20 - 30



DOT QUADRO 20				(W)	(lm)	(V)	(K)	(CRI)
	Bi	1224-Q-LBC	1226-Q-LBC	1,2W	90	350mA	3000	>90
	Ne	1225-Q-LBC	1227-Q-LBC					
	Bi	1224-Q-LBN	1226-Q-LBN	1,2W	100	350mA	4000	>90
	Ne	1225-Q-LBN	1227-Q-LBN					

ALIMENTATORI CONSIGLIATI - RECOMMENDED DRIVERS

644758	ON-OFF	8W	IP20	350mA
644759-1	ON-OFF	15W	IP20	350mA

		K I T 4 APPARECCHI + ALIMENTATORE - 4 FITTINGS + DRIVER		(W)	(lm)	(V)	(K)	(CRI)
	Bi	KT1224Q-LBC4	KT1226Q-LBC4	4x 1,2W	90	220-240V [350mA]	3000	>90
	Ne	KT1225Q-LBC4	KT1227Q-LBC4					
	Bi	KT1224Q-LBN4	KT1226Q-LBN4	4x 1,2W	100	220-240V [350mA]	4000	>90
	Ne	KT1225Q-LBN4	KT1227Q-LBN4					
	Bi	KT1224Q-LBC12	KT1226Q-LBC12	12x 1,2W	90	220-240V [350mA]	3000	>90
	Ne	KT1225Q-LBC12	KT1227Q-LBC12					
	Bi	KT1224Q-LBN12	KT1226Q-LBN12	12x 1,2W	100	220-240V [350mA]	4000	>90
	Ne	KT1225Q-LBN12	KT1227Q-LBN12					

DOT QUADRO 30				(W)	(lm)	(V)	(K)	(CRI)
	Bi	1220-Q-LBC	1222-Q-LBC	1,2W	90	350mA	3000	>90
	Ne	1221-Q-LBC	1223-Q-LBC					
	Bi	1220-Q-LBN	1222-Q-LBN	1,2W	100	350mA	4000	>90
	Ne	1221-Q-LBN	1223-Q-LBN					

ALIMENTATORI CONSIGLIATI - RECOMMENDED DRIVERS

644758	ON-OFF	8W	IP20	350mA
644759-1	ON-OFF	15W	IP20	350mA

		K I T 4 APPARECCHI + ALIMENTATORE - 4 FITTINGS + DRIVER		(W)	(lm)	(V)	(K)	(CRI)
	Bi	KT1220Q-LBC4	KT1222Q-LBC4	4x 1,2W	90	220-240V [350mA]	3000	>90
	Ne	KT1221Q-LBC4	KT1223Q-LBC4					
	Bi	KT1220Q-LBN4	KT1222Q-LBN4	4x 1,2W	100	220-240V [350mA]	4000	>90
	Ne	KT1221Q-LBN4	KT1223Q-LBN4					
	Bi	KT1220Q-LBC12	KT1222Q-LBC12	12x 1,2W	90	220-240V [350mA]	3000	>90
	Ne	KT1221Q-LBC12	KT1223Q-LBC12					
	Bi	KT1220Q-LBN12	KT1222Q-LBN12	12x 1,2W	100	220-240V [350mA]	4000	>90
	Ne	KT1221Q-LBN12	KT1223Q-LBN12					

OP: A richiesta - On request: disponibile - available



SHELF LED T-Q COB



- Incasso per mensole con anello in acciaio verniciato.
 - Verniciatura in polveri di poliestere.
 - Molle di fissaggio e schermo in materiale termoplastico.
 - Dissipatore e cavetto lunghezza 0,3 m.
- Recessed spot for shelves with ring made of coated steel.
 - Polyester powder coating
 - Fixing springs and screen made of thermoplastic material.
 - Heatsink and power cables length 0,3 m.



58 mm

LAMP	VOLT-MA	WATT	LUMEN	HOUR*
SHELF LED COB	350mA	3,5W	285	50.000
SHELF LED	350mA 700mA	1,2W 2,5W	80 121	50.000
H56 G4	12V	10W 20W	140 300	2.000

* HOUR Durata media - Average Life

SHELF LED T COB

	W	lm	V	K	CRI
Bi 0021COB					
Ne 0022COB	1x3,5W	285	350mA	3000	+90
Cr 0023COB					
Oro 0024COB					
Cm 0025COB					

Technical drawing: diameter 67 mm, height 4.18 mm, weight 0.07 kg.



58 mm

SHELF LED Q COB

	W	lm	V	K	CRI
Bi 0021COB-Q					
Ne 0022COB-Q	1x3,5W	285	350mA	3000	+90
Cr 0023COB-Q					
Oro 0024COB-Q					
Cm 0025COB-Q					

Technical drawing: diameter 72 mm, height 4.18 mm, weight 0.07 kg.



58 mm

SHELF LED T COB - IP54

	W	lm	V	K	CRI
Bi 0021COB-54					
Ne 0022COB-54	1x3,5W	285	350mA	3000	+90
Cr 0023COB-54					

Technical drawing: diameter 67 mm, height 4.18 mm, weight 0.07 kg.



58 mm

ALIMENTATORI CONSIGLIATI - RECOMMENDED DRIVERS

644758	DN-OFF	8W	IP20	350mA
644759-1	DN-OFF	15W	IP20	350mA

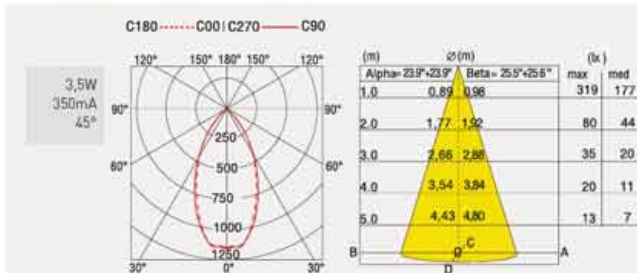

ALIMENTATORI-KIT RGB (se non in dotazione) da ordinare dalla sezione arancio - DRIVERS-RGB KITS (when not supplied) to be ordered from the section orange color





- Corpo in alluminio verniciato.
- Verniciatura in polveri di poliestere.
- Aluminium painted body.
- Polyester powder coating





INCASSO FISSO - FIXED RECESSED

Br 2845-S
Ne 2846-S
Cr 2847-S
Oro 2848-S

LAMPADINA NON INCLUSA - BULB NOT INCLUDED





INCASSO SEMIORIENTABILE - SEMI-ADJUSTABLE RECESSED

Br 2855-S
Ne 2856-S
Cr 2857-S
Oro 2858-S

LAMPADINA NON INCLUSA - BULB NOT INCLUDED



Gli apparecchi non sono muniti né di lampada né di alimentatore indipendente che potranno essere ordinati a SIDE a seconda del tipo di fascio e di potenza desiderata.
The fittings are not equipped with led lamp neither independent driver. Both of them can be ordered to SIDE depending on the type of beam and the required power.

			Ⓜ	Ⓜ	Ⓜ	Ⓜ	Ⓜ	Ⓜ			
	+		+		MR11 - LAMPADINE LED CONSIGLIATE - RECOMMENDED LED BULB						
COD 2845-S		COD 615810		COD 645586	615810	GU4	3,5W	210	12Vac	2700	>90
					ALIMENTATORI CONSIGLIATI - RECOMMENDED DRIVERS						
					645586	50W					

	+		+		COIN 35 - LAMPADINE LED CONSIGLIATE - RECOMMENDED LED BULB						
COD 2845-S		COD 646689-930		COD 646209	646689-930	GU4	4,9W	460	150mA	3000	>90
					646689-940			500		4000	
					ALIMENTATORI CONSIGLIATI - RECOMMENDED DRIVERS						
					646209	50W					

IP 20



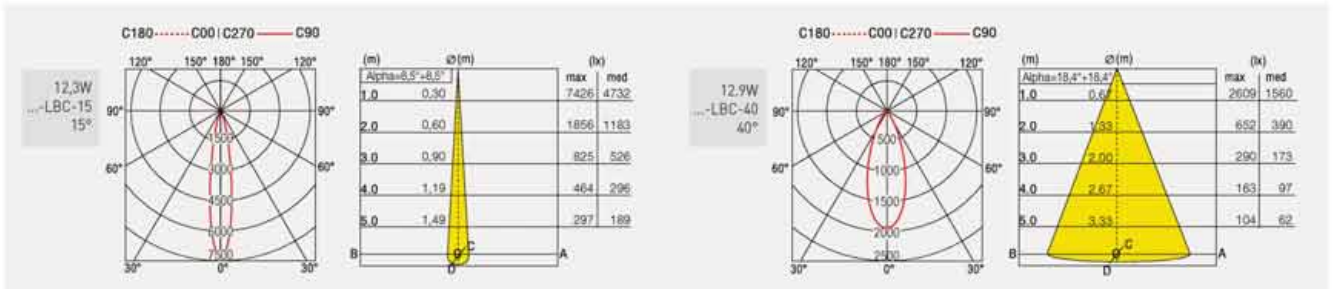

ALIMENTATORI-KIT RGB (se non in dotazione) da ordinare dalla sezione arancio - DRIVERS-RGB KITS (when not supplied) to be ordered from the section orange color

JOCKER COB



- Incasso in pressofusione di alluminio.
- Verniciatura in polveri di poliestere.
- Recessed trim of die-cast aluminium.
- Polyester powder coating

INCASSI • RECESSED

LED COB			(W)	(lm)	(V)	(K)	(°)	(CRI)
---------	--	--	-----	------	-----	-----	-----	-------

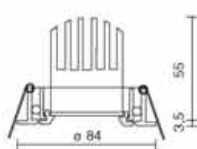

INCASSI FISSI - FIXED RECESSED

Bi	2815C-LBC-15							
Ne	2816C-LBC-15	▲15	12,3W	1040	350mA	3000		>90
Cr	2817C-LBC-15							
OrO	2818C-LBC-15							
Bi	2815C-LBN-15							
Ne	2816C-LBN-15	▲15	12,3W	1120	350mA	4000		>90
Cr	2817C-LBN-15							
OrO	2818C-LBN-15							
Bi	2815C-LBC-24							
Ne	2816C-LBC-24	▲24	12,9W	1430	350mA	3000		>90
Cr	2817C-LBC-24							
OrO	2818C-LBC-24							
Bi	2815C-LBN-24							
Ne	2816C-LBN-24	▲24	12,9W	1510	350mA	4000		>90
Cr	2817C-LBN-24							
OrO	2818C-LBN-24							
Bi	2815C-LBC-40							
Ne	2816C-LBC-40	▲40	12,9W	1360	350mA	3000		>90
Cr	2817C-LBC-40							
OrO	2818C-LBC-40							
Bi	2815C-LBN-40							
Ne	2816C-LBN-40	▲40	12,9W	1430	350mA	4000		>90
Cr	2817C-LBN-40							
OrO	2818C-LBN-40							

1Kg
0.30



76 mm Δ 0÷20 mm

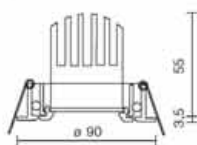

INCASSI SEMIORIENTABILI - SEMI-ADJUSTABLE RECESSED

Bi	2825C-LBC-15							
Ne	2826C-LBC-15	▲15	12,3W	1040	350mA	3000		>90
Cr	2827C-LBC-15							
OrO	2828C-LBC-15							
Bi	2825C-LBN-15							
Ne	2826C-LBN-15	▲15	12,3W	1120	350mA	4000		>90
Cr	2827C-LBN-15							
OrO	2828C-LBN-15							
Bi	2825C-LBC-24							
Ne	2826C-LBC-24	▲24	12,9W	1430	350mA	3000		>90
Cr	2827C-LBC-24							
OrO	2828C-LBC-24							
Bi	2825C-LBN-24							
Ne	2826C-LBN-24	▲24	12,9W	1510	350mA	4000		>90
Cr	2827C-LBN-24							
OrO	2828C-LBN-24							
Bi	2825C-LBC-40							
Ne	2826C-LBC-40	▲40	12,9W	1360	350mA	3000		>90
Cr	2827C-LBC-40							
OrO	2828C-LBC-40							
Bi	2825C-LBN-40							
Ne	2826C-LBN-40	▲40	12,9W	1430	350mA	4000		>90
Cr	2827C-LBN-40							
OrO	2828C-LBN-40							

1Kg
0.30



82 mm Δ 0÷20 mm

ALIMENTATORI CONSIGLIATI - RECOMMENDED DRIVERS

644759-1	ON-OFF	15W	IP20	350mA
645984	ON-OFF	15W	IP40	350mA

- ACC. 116 Anello di compensazione - Compensation ring - Jocker COB
d=75 mm/D=150 mm
- 117 Anello di compensazione - Compensation ring - Jocker COB ORIENTABILE
d=80 mm/D=160 mm

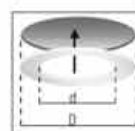

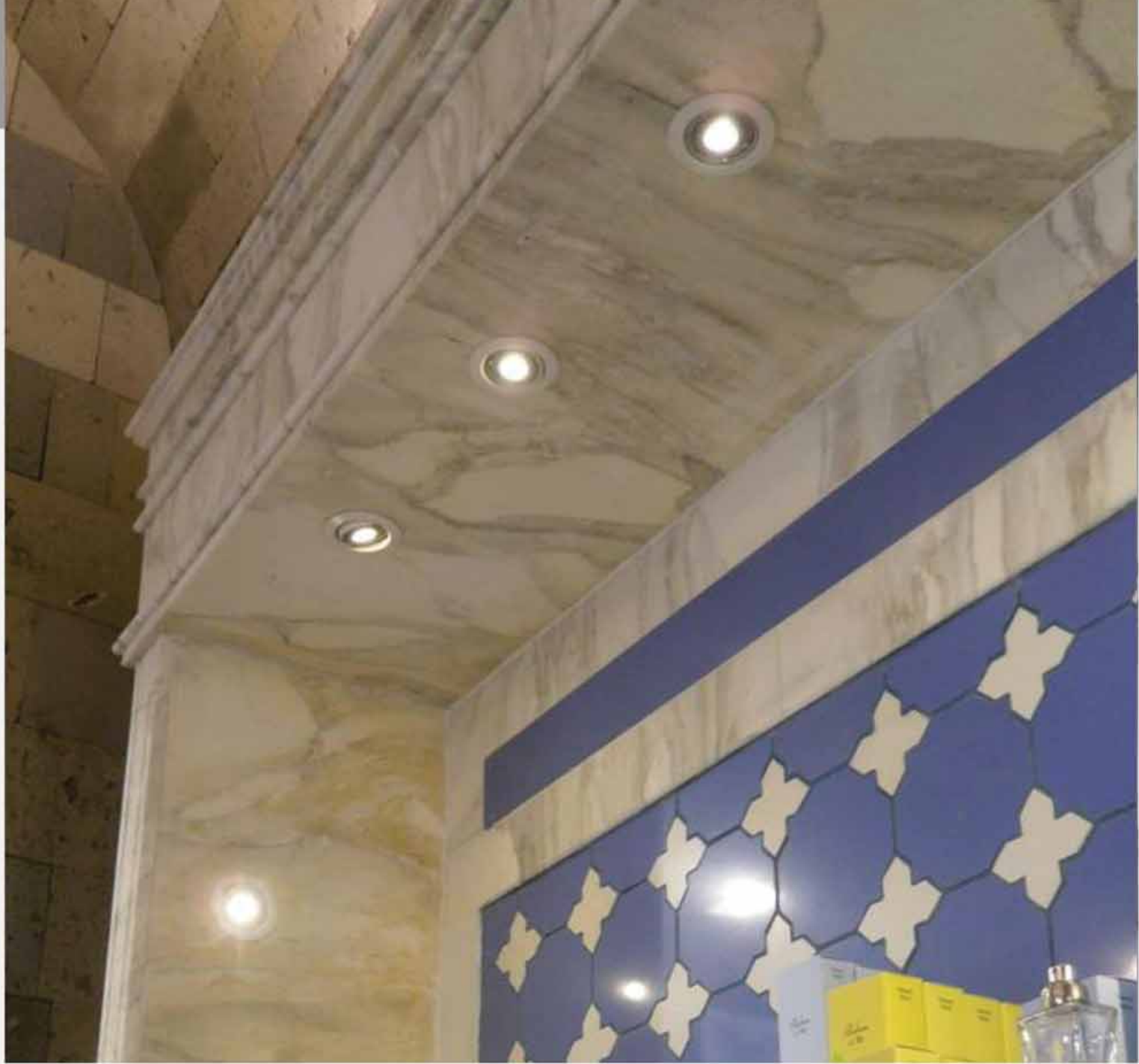

JOCKER 3 LED



82 mm $\Delta = 0+20$ mm



- Incasso in pressofusione di alluminio.
- Verniciatura in polveri di poliestere.
- 3 power Led con lenti.
- Recessed trim of die-cast aluminium.
- Polyester powder coating
- 3 power-Led with lens.

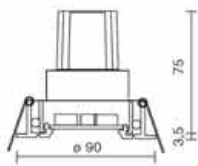
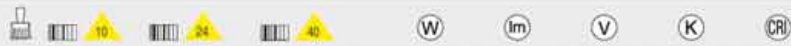

INCASSI SEMIORIENTABILI - SEMI-ADJUSTABLE RECESSED

Bl	2825-RGB-10	2825-RGB-30	2825-RGB-45				
Na	2826-RGB-10	2826-RGB-30	2826-RGB-45	3x1W	-	350mA	
Cr	2827-RGB-10	2827-RGB-30	2827-RGB-45				
Oro	2828-RGB-10	2828-RGB-30	2828-RGB-45				

5xg
0,30

OP. ---LBI = LED blu-blue

ACC. 117 Anello di compensazione - Compensation ring - JOCKER 3 LED SEMIORIENTABILE
d=80 mm/D=160 mm

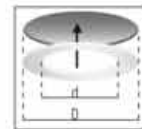

IP 20
IP 20

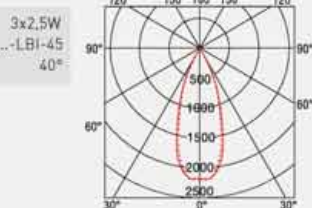
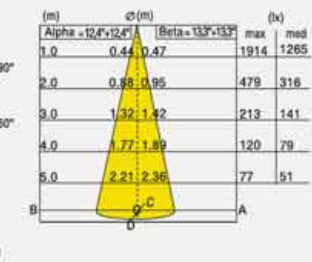
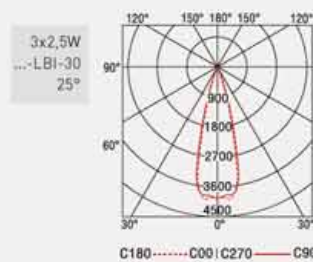
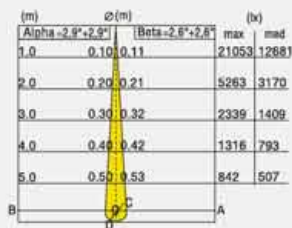
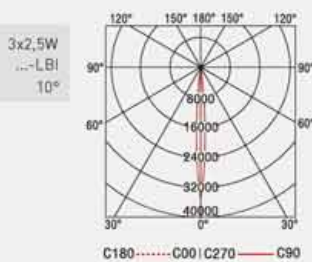



MODULO LED DI RICAMBIO - LED MODULE REPLACEMENT

645646-BC	Modulo-Module Led COB	830lm	3000K	25°
645646-BN	Modulo-Module Led COB	900lm	4000K	25°
645646-BI	Modulo-Module Led COB	1100lm	5600K	25°
645647-BC	Modulo-Module Led COB	830lm	3000K	40°
645647-BN	Modulo-Module Led COB	900lm	4000K	40°
645647-BI	Modulo-Module Led COB	1100lm	5600K	40°



OR A richiesta - On request: disponibile - available



- ACC. 116 Anello di compensazione - Compensation ring - JÖCKER EMME
d=75 mm/D=150 mm
- 117 Anello di compensazione - Compensation ring - JÖCKER EMME ORIENTABILE
d=80 mm/D=160 mm

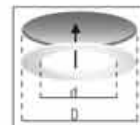

*Solo apparecchio - Only fitting

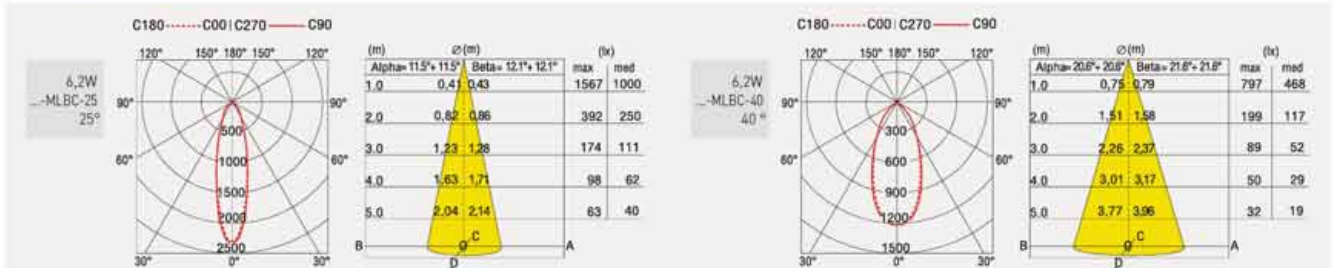

ALIMENTATORI-KIT RGB (se non in dotazione) da ordinare dalla sezione arancio - DRIVERS-RGB KITS (when not supplied) to be ordered from the section orange color

JOCKER EMME

FISSO - FIXED

SEMIORIENTABILE - SEMI-ADJUSTABLE



76 mm $\Delta = 0+20$ mm



82 mm $\Delta = 0+20$ mm



- Incasso in pressofusione di alluminio.
- Verniciatura in polveri di poliestere.
- Modulo Led COB in dotazione con schermo opale e dissipatore in alluminio anodizzato.
- Modulo Led COB sostituibile.
- Riflettore in materiale termoplastico metallizzato.
- Durata nominale: 50000 (h) L80 B50.

- Recessed trim of die-cast aluminium.
- Polyester powder coating
- Supplied COB Led module with opal screen and anodized aluminium heatsink.
- Easy replacement of the COB Led module.
- Metalized thermoplastic material reflector.
- Led life: 50000 (h) L80 B50.

LED COB		25	40	W	lm	V	K	CRI
		INCASSI FISSI - FIXED RECESSED						
Bi	2815-MLBC-25	2815-MLBC-40						
Ne	2816-MLBC-25	2816-MLBC-40						
Cr	2817-MLBC-25	2817-MLBC-40		1x6,2W	770	350mA	3000	>90
Oro	2818-MLBC-25	2818-MLBC-40						
Bi	2815-MLBN-25	2815-MLBN-40						
Ne	2816-MLBN-25	2816-MLBN-40						
Cr	2817-MLBN-25	2817-MLBN-40		1x6,2W	860	350mA	4000	>90
Oro	2818-MLBN-25	2818-MLBN-40						

LED COB		25	40	LED					SISTEMA-SYSTEM		
				W	lm	V	K	CRI	W	lm	W
		KIT APPARECCHIO + ALIMENTATORE - FITTING + DRIVER									
INCASSI FISSI - FIXED RECESSED											
Bi	KT2815-MLBC25	KT2815-MLBC40									
Ne	KT2816-MLBC25	KT2816-MLBC40									
Cr	KT2817-MLBC25	KT2817-MLBC40		1x6,2W	770	350mA	3000	>90	7,2W	770	107
Oro	KT2818-MLBC25	KT2818-MLBC40									
Bi	KT2815-MLBN25	KT2815-MLBN40									
Ne	KT2816-MLBN25	KT2816-MLBN40									
Cr	KT2817-MLBN25	KT2817-MLBN40		1x6,2W	860	350mA	4000	>90	7,2W	860	119
Oro	KT2818-MLBN25	KT2818-MLBN40									

LED COB		25	40	W	lm	V	K	CRI
		INCASSI SEMIORIENTABILI - SEMI-ADJUSTABLE RECESSED						
Bi	2825-MLBC-25	2825-MLBC-40						
Ne	2826-MLBC-25	2826-MLBC-40						
Cr	2827-MLBC-25	2827-MLBC-40		1x6,2W	770	350mA	3000	>90
Oro	2828-MLBC-25	2828-MLBC-40						
Bi	2825-MLBN-25	2825-MLBN-40						
Ne	2826-MLBN-25	2826-MLBN-40						
Cr	2827-MLBN-25	2827-MLBN-40		1x6,2W	860	350mA	4000	>90
Oro	2828-MLBN-25	2828-MLBN-40						

LED COB		25	40	LED					SISTEMA-SYSTEM		
				W	lm	V	K	CRI	W	lm	W
		KIT APPARECCHIO + ALIMENTATORE - FITTING + DRIVER									
INCASSI SEMIORIENTABILI - SEMI-ADJUSTABLE RECESSED											
Bi	KT2825-MLBC25	KT2825-MLBC40									
Ne	KT2826-MLBC25	KT2826-MLBC40									
Cr	KT2827-MLBC25	KT2827-MLBC40		1x6,2W	770	350mA	3000	>90	7,2W	770	107
Oro	KT2828-MLBC25	KT2828-MLBC40									
Bi	KT2825-MLBN25	KT2825-MLBN40									
Ne	KT2826-MLBN25	KT2826-MLBN40									
Cr	KT2827-MLBN25	KT2827-MLBN40		1x6,2W	860	350mA	4000	>90	7,2W	860	119
Oro	KT2828-MLBN25	KT2828-MLBN40									



*Solo apparecchio - Only fitting

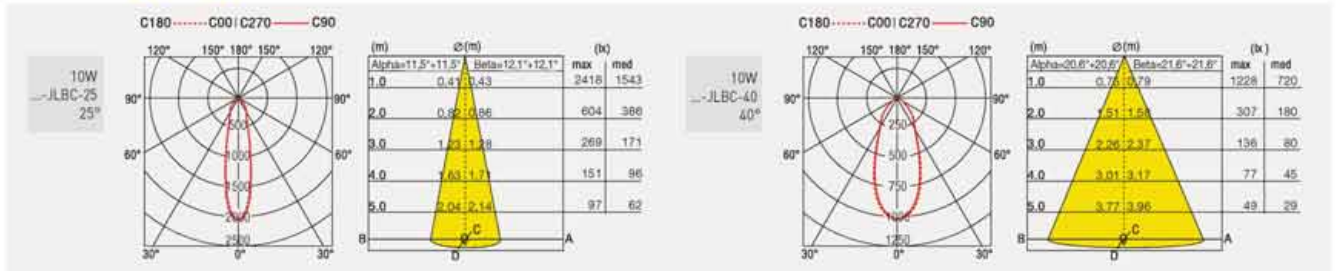

ALIMENTATORI-KIT RGB (se non in dotazione) da ordinare dalla sezione arancio - DRIVERS-RGB KITS (when not supplied) to be ordered from the section orange color



- Incasso e corpo modulo orientabile in pressofusione di alluminio.
- Verniciatura in polveri di poliesteri.
- Modulo Led COB ceramico con schermo opale.
- Riflettore in materiale termoplastico metallizzato in alto vuoto.
- Molle in acciaio in fissaggio al controsoffitto.
- Led durata utile: 50.000 (h) L90 B10 - McAdam 3.
- Consistenza cromatica: 3 SDCM.

- Frame and adjustable body module of die cast aluminium.
- Polyester powder coating
- Led COB ceramic module with opal screen.
- High vacuum metallized thermoplastic reflector.
- Steel springs for fixing to the false-ceiling.
- Led life: 50.000 (h) L90 B10 - McAdam 3.
- Chromatic consistency: 3 SDCM.



82 mm $\Delta = 0+20$ mm



LED COB				W	lm	V	K	CRi
Bi	2825-JLBC-25	2825-JLBC-40		12W	1200	350mA	3000	>95
Ne	2826-JLBC-25	2826-JLBC-40						
Bi	2825-JLBN-25	2825-JLBN-40		12W	1300	350mA	4000	>95
Ne	2826-JLBN-25	2826-JLBN-40						
Bi	2825-JLBC-25K	2825-JLBC-40K		12W	1200	350mA	2700	>95
Ne	2826-JLBC-25K	2826-JLBC-40K						

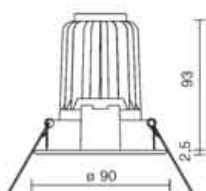

ALIMENTATORI CONSIGLIATI - RECOMMENDED DRIVERS

644759-1	ON-OFF	15W		
644757	DIM PUSH/1-10V	25W		
644757-DA	DIM DALI	25W	IP20	350mA
645939	DIM DALI	25W		

LED COB		LED					SISTEMA-SYSTEM			
		W	lm	V	K	CRi	W	lm	IP	
KIT APPARECCHIO + ALIMENTATORE - FITTING + DRIVER										
Bi	KT2825-JLBC25	KT2825-JLBC40	12W	1200	220-240V [350mA]	3000	>95	14W	1037	74 25°
Ne	KT2826-JLBC25	KT2826-JLBC40						1014	72 40°	
Bi	KT2825-JLBN25	KT2825-JLBN40	12W	1300	220-240V [350mA]	4000	>95	14W	1124	80 25°
Ne	KT2826-JLBN25	KT2826-JLBN40						1098	78 40°	

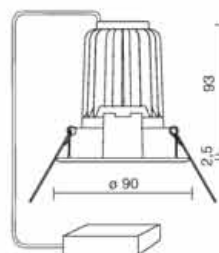

OP. A richiesta - On request: disponibile - available



ACC. 117 Anello di compensazione - Compensation ring

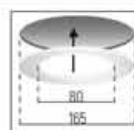

FOCUS XS

- Anello di finitura in acciaio verniciato.
- Riflettore in alluminio purissimo.
- Fissaggio a controsoffitto con molle.
- Dissipatore lamellare passivo in alluminio estruso.
- Gruppo ottico orientabile 0-40°.
- Elevato comfort visivo grazie alla posizione arretrata della sorgente luminosa Led.
- Led durata utile: 50.000 (h) L90 B10.
- Consistenza cromatica: 3 SDCM.

- Finishing coated steel ring.
- Pure aluminium reflector.
- Fixing to false-ceiling with springs.
- Passive heatsink of extruded aluminium.
- Optical adjustable unit 0-40°.
- High visual comfort thanks to the backward position of the Led light source.
- Led life: 50.000 (h) L90 B10.
- Chromatic consistency: 3 SDCM.



95 mm Δ 0+40 mm



$$UGR = 8 \log_{10} \left[\frac{0,25}{L_b} \sum \frac{L_i^2 \omega_i}{p^2} \right]$$

	LED					SISTEMA-SYSTEM		
	W	lm	V	K	CRI	W	lm	lm
 TONDO - ROUND Br 67920-LBC Ne 67921-LBC Ga 67922-LBC 0,90	11,5W	1840	350mA	3000	>90	11,5W	920	80
	11,5W	1950	350mA	4000	>90	11,5W	995	86
	Br 67920-LBN Ne 67921-LBN Ga 67922-LBN							

 QUADRO - SQUARE Br 67923-LBC Ne 67924-LBC Ga 67925-LBC 0,90	11,5W	1840	350mA	3000	>90	11,5W	920	80
	11,5W	1950	350mA	4000	>90	11,5W	995	86
	Br 67923-LBN Ne 67924-LBN Ga 67925-LBN							

ALIMENTATORI CONSIGLIATI (n. 1 per ogni faretto) - DRIVERS RECOMMENDED (n. 1 for each item)

644759-1	ON-OFF				
645938	DIM 1+ 10V/PUSH	MINI JOLLY 20	15W	IP20	350mA
645939	DIM DALI	MINI JOLLY 20			

DP A richiesta - On request. Versione IP44 - IP44 version
Led con temperatura di COLORE 2700K - Temperature Led COLOUR 2700K

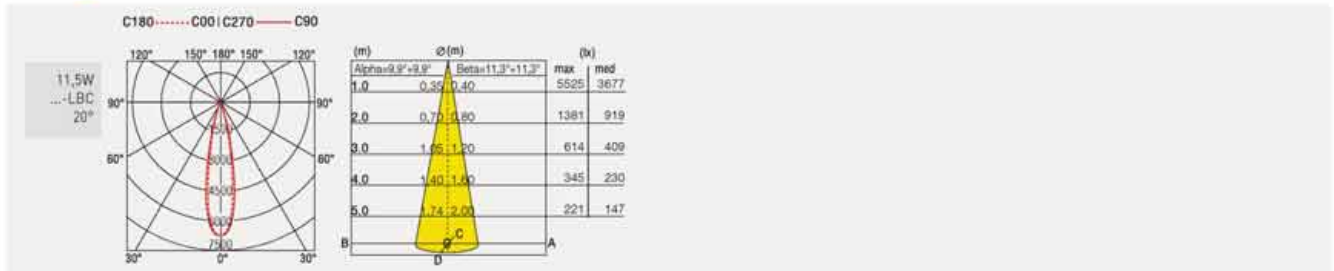

ALIMENTATORI-KIT RGB (se non in dotazione) da ordinare dalla sezione arancio - DRIVERS-RGB KITS (when not supplied) to be ordered from the section orange color



- Anello di finitura in acciaio verniciato.
- Riflettore in alluminio purissimo.
- Fissaggio a controsoffitto con molle.
- Dissipatore lamellare passivo in alluminio estruso.
- Gruppo ottico orientabile 0-40°.
- Elevato comfort visivo grazie alla posizione arretrata della sorgente luminosa Led.
- Led durata utile: 50.000 (h) L90 B10.
- Consistenza cromatica: 3 SDCM.

- Finishing coated steel ring.
- Pure aluminium reflector.
- Fixing to false-ceiling with springs.
- Passive heatsink of extruded aluminium.
- Optical adjustable unit 0-40°.
- High visual comfort thanks to the backward position of the Led light source.
- Led life: 50.000 (h) L90 B10.
- Chromatic consistency: 3 SDCM.



115 mm 0÷40 mm

UGR < 13 $UGR = 8 \log_{10} \left[\frac{0,25}{L_b} \sum \frac{L_p^2}{p^2} \right]$

	LED					SISTEMA-SYSTEM		
	W	lm	V	K	CRI	W	lm	lm/W
 TONDO - ROUND Br 67926-LBC Ne 67927-LBC Ga 67928-LBC  1,40	24W	3365	700mA	3000	>90	24W	1727	72
	24W	3570	700mA	4000	>90	24W	1940	81
	Br 67926-LBN Ne 67927-LBN Ga 67928-LBN							

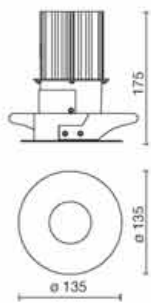

	LED					SISTEMA-SYSTEM		
	W	lm	V	K	CRI	W	lm	lm/W
 QUADRO - SQUARE Br 67929-LBC Ne 67930-LBC Ga 67931-LBC  1,40	24W	3365	700mA	3000	>90	24W	1727	72
	24W	3570	700mA	4000	>90	24W	1940	81
	Br 67929-LBN Ne 67930-LBN Ga 67931-LBN							

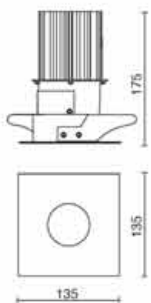

ALIMENTATORI CONSIGLIATI (n. 1 per ogni faretto) - DRIVERS RECOMMENDED (n. 1 for each item)

645688	ON-OFF	700mA
645849-I	DIM DALI/PUSH	350/900mA
644757-DA	DIM DALI	700mA
645940	DIM 1+ 10V/PUSH JOLLY US 32	700mA

DR A richiesta - On request: Versione IP44 - IP44 version
 Led con temperatura di COLORE 2700K - Temperature Led COLOUR 2700K

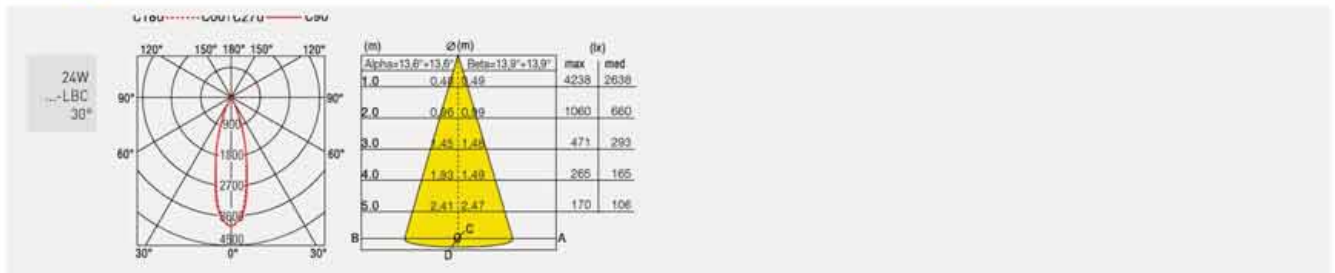

ALIMENTATORI-KIT RGB (se non in dotazione) da ordinare dalla sezione arancio - DRIVERS-RGB KITS (when not supplied) to be ordered from the section orange color





FOCUS XS/XL - SC
SENZA CORNICE - TRIMLESS

- Anello di finitura in acciaio verniciato.
- Riflettore in alluminio purissimo.
- Fissaggio a controsoffitto con molle.
- Dissipatore lamellare passivo in alluminio estruso.
- Gruppo ottico orientabile 0-40°.
- Elevato comfort visivo grazie alla posizione arretrata della sorgente luminosa Led.
- Versione SC adatta per controsoffitti a rasamento.
- Led durata utile: 50.000 (h) L90 B10.
- Consistenza cromatica: 3 SDCM.

- Finishing coated steel ring.
- Pure aluminium reflector.
- Fixing to false-ceiling with springs.
- Passive heatsink of extruded aluminium.
- Optical adjustable unit 0-40°.
- High visual comfort thanks to the backward position of the Led light source.
- SC version suitable for shim false-ceiling.
- Led life: 50.000 (h) L90 B10.
- Chromatic consistency: 3 SDCM.

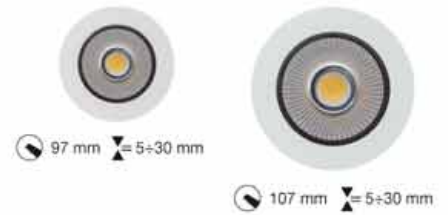

UGR < 13 $UGR = 8 \log_{10} \left[\frac{0,25}{L_b} \sum \frac{L^2 \theta^2}{p^3} \right]$

	Br	67932-LBC 67932-LBN	LED					SISTEMA-SYSTEM		
			W	lm	V	K	CRI	W	lm	IP
	0,90		11,5W	1940 1950	350mA	3000 4000	>90	11,5W	920 995	80 86

ALIMENTATORI CONSIGLIATI (n. 1 per ogni faretto) - DRIVERS RECOMMENDED (n. 1 for each item)

644759-1	ON-OFF		15W	IP20	350mA
645938	DIM 1- 10V/PUSH	MINI JOLLY 20			
645939	DIM DALI	MINI JOLLY DALI 20			

	Br	67933-LBC 67933-LBN	LED					SISTEMA-SYSTEM		
			W	lm	V	K	CRI	W	lm	IP
	1,40		24W	3365 3570	700mA	3000 4000	>90	24W	1727 1940	72 81

ALIMENTATORI CONSIGLIATI (n. 1 per ogni faretto) - DRIVERS RECOMMENDED (n. 1 for each item)

645688	ON-OFF		35W	IP20	700mA
645849-1	DIM DALI/PUSH		35W	IP20	350/900mA
644757-DA	DIM DALI		32W	IP20	700mA
645939	DIM DALI	MINI JOLLY DALI 20	20W	IP20	700mA

OP. A richiesta - On request: Versione IP44 - IP44 version
Led con temperatura di COLORE 2700K - Temperature Led COLOUR 2700K

VERSIONE SENZA CORNICE RASAMENTO A FILO CARTONGESSO
TRIMLESS VERSION FOR PLASTERBOARD CEILINGS

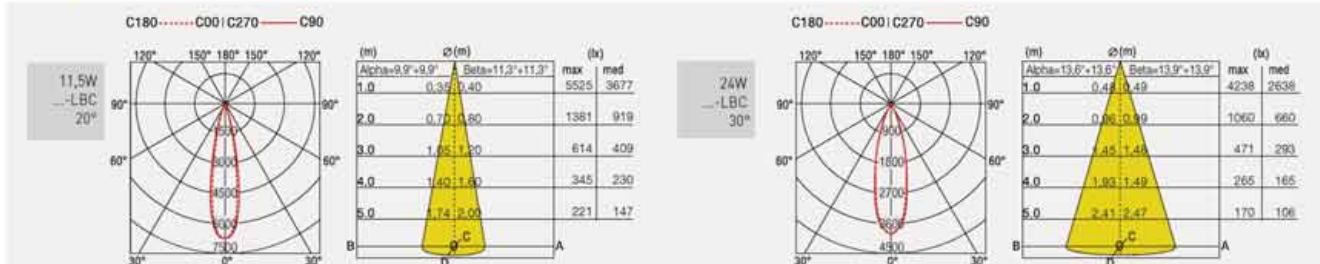
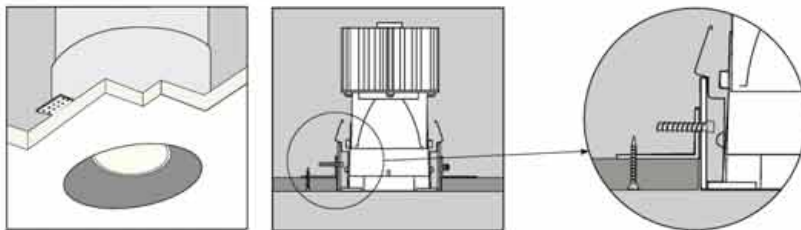

ALIMENTATORI-KIT RGB (se non in dotazione) da ordinare dalla sezione arancio - DRIVERS-RGB KITS (when not supplied) to be ordered from the section orange color



CO-LIGHT MINI 60



- Struttura in lamiera verniciata a polvere e molle di fissaggio.
- Sorgente luminosa ad alta resa completa di dissipatore in alluminio.
- Raffreddamento Led passivo con dissipatore.

- Painted steel powder coated body and lock spring.
- High efficiency lighting source with aluminium heatsink.
- Passive cooling Led with heatsink.



61 mm 5+30 mm

INCASSI • RECESSED

				(W)	(lm)	(V)	(K)	(CRI)	
	Br	2891C-LBC-15							
	Ne	2892C-LBC-15	15	12,3W	1040	350mA	3000	>90	
	Gr	2893C-LBC-15							
	Br	2891C-LBN-15							
	Ne	2892C-LBN-15	15	12,3W	1120	350mA	4000	>90	
	Gr	2893C-LBN-15							
	Br	2891C-LBC-24							
	Ne	2892C-LBC-24	24	12,9W	1430	350mA	3000	>90	
	Gr	2893C-LBC-24							
	Br	2891C-LBN-24							
	Ne	2892C-LBN-24	24	12,9W	1510	350mA	4000	>90	
	Gr	2893C-LBN-24							
	Br	2891C-LBC-40							
	Ne	2892C-LBC-40	40	12,9W	1360	350mA	3000	>90	
	Gr	2893C-LBC-40							
	Br	2891C-LBN-40							
	Ne	2892C-LBN-40	40	12,9W	1430	350mA	4000	>90	
	Gr	2893C-LBN-40							
ALIMENTATORI CONSIGLIATI - RECOMMENDED DRIVERS									
644759-1	DN-OFF	15W	IP20	350mA					
645984	DN-OFF	15W	IP20	350mA					





ALIMENTATORI-KIT RGB (se non in dotazione) da ordinare dalla sezione arancio - DRIVERS-RGB KITS (when not supplied) to be ordered from the section orange color





IP 20
IP 40











 RG 0

 10

 15

 24

 40

 5 ANNI

ALIMENTATORI-KIT RGB (se non in dotazione) da ordinare dalla sezione arancio - DRIVERS-RGB KITS (when not supplied) to be ordered from the section orange color





CO-LIGHT MINI



85 mm 5±30 mm

- Struttura in lamiera verniciata a polvere e molle di fissaggio.
- Sorgente luminosa ad alta resa completa di dissipatore in alluminio.
- Raffreddamento Led passivo con dissipatore.
- Painted steel powder coated body and lock spring.
- High efficiency lighting source with aluminium heatsink.
- Passive cooling Led with dissipator.

LED COB					(W)	(lm)	(V)	(K)	(CRI)
	Br	2819C-LBC-15			12,3W	1040	350mA	3000	>90
	Ne	2820C-LBC-15	15						
	Gr	2821C-LBC-15							
	Br	2819C-LBN-15			12,3W	1120	350mA	4000	>90
	Ne	2820C-LBN-15	15						
	Gr	2821C-LBN-15							
	Br	2819C-LBC-24			12,9W	1430	350mA	3000	>90
	Ne	2820C-LBC-24	24						
	Gr	2821C-LBC-24							
	Br	2819C-LBN-24			12,9W	1510	350mA	4000	>90
	Ne	2820C-LBN-24	24						
	Gr	2821C-LBN-24							
Br	2819C-LBC-40			12,9W	1360	350mA	3000	>90	
Ne	2820C-LBC-40	40							
Gr	2821C-LBC-40								
Br	2819C-LBN-40			12,9W	1430	350mA	4000	>90	
Ne	2820C-LBN-40	40							
Gr	2821C-LBN-40								

ALIMENTATORI CONSIGLIATI - RECOMMENDED DRIVERS

644759-1	ON-OFF	15W	IP20	350mA
645984	ON-OFF	15W	IP20	350mA

LED COB									
	VERSIONE RGB CON 3 LED - 3 LED RGB VERSIONS								
	Br	2819-RGB-10	2819-RGB-30	2819-RGB-45	3x1W	-	350mA		-
	Ne	2820-RGB-10	2820-RGB-30	2820-RGB-45					
	Gr	2821-RGB-10	2821-RGB-30	2821-RGB-45					

OP.-LBL. = LED blu-blue

ACC. 145 Piastra di rinforzo - Reinforcement plate







CO-LIGHT MINI EMME



85 mm \times 5+30 mm

- Struttura in lamiera verniciata a polvere e molle di fissaggio a filo.
- Modulo Led COB in dotazione con schermo opale e dissipatore in alluminio anodizzato.
- Painted steel powder coated body and lock spring at flat level.
- Supplied COB Led module with opal screen and anodized aluminium heatsink.

				(W)	(lm)	(V)	(K)	(CRI)
	Br	2819-MLBC-25	2819-MLBC-40					
	Ne	2820-MLBC-25	2820-MLBC-40	1x6,2W	770	350mA	3000	>90
	Gr	2821-MLBC-25	2821-MLBC-40					
	Br	2819-MLBN-25	2819-MLBN-40					
	Ne	2820-MLBN-25	2820-MLBN-40	1x6,2W	860	350mA	4000	>90
	Gr	2821-MLBN-25	2821-MLBN-40					
	Br	2819-MLBI-25	2819-MLBI-40					
	Ne	2820-MLBI-25	2820-MLBI-40	1x6,2W	960	350mA	5600	>90
	Gr	2821-MLBI-25	2821-MLBI-40					

ALIMENTATORI CONSIGLIATI - RECOMMENDED DRIVERS

644759-1	ON-OFF	15W	IP20	350mA
646427	ON-OFF	12W	IP20	350mA
644758	ON-OFF	8W	IP20	350mA

MODULO LED DI RICAMBIO - LED MODULE REPLACEMENT

645646-BC	Modulo-Module Led COB	830lm	3000K	25°
645646-BN	Modulo-Module Led COB	900lm	4000K	25°
645646-BI	Modulo-Module Led COB	1100lm	5600K	25°
645647-BC	Modulo-Module Led COB	830lm	3000K	40°
645647-BN	Modulo-Module Led COB	900lm	4000K	40°
645647-BI	Modulo-Module Led COB	1100lm	5600K	40°

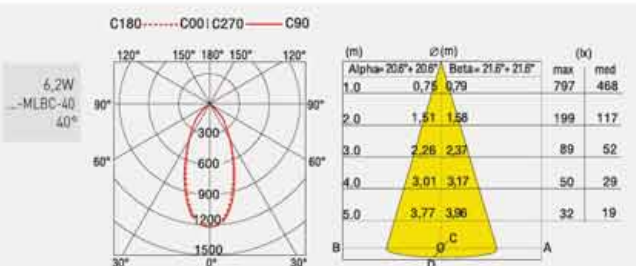
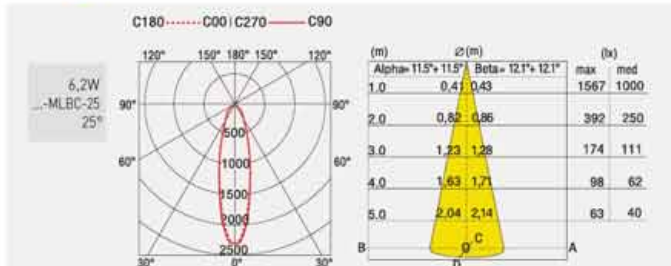

ALIMENTATORI-KIT RGB (se non in dotazione) da ordinare dalla sezione arancio - DRIVERS-RGB KITS (when not supplied) to be ordered from the section orange color



SEMIORIENTABILI - SEMI-ADJUSTABLE



95 mm $\Delta = 1+30$ mm



- Corpo in pressofusione di alluminio verniciato.
- Verniciatura in polveri di poliestere.
- Fissaggio tramite molle in acciaio.
- Riflettore in alluminio purissimo, metallizzato in alto vuoto.
- Vetro temprato chiaro.
- Fermacavo in nylon 66.
- Durata nominale: 50000 (h) L90 B20.
- Costanza cromatica: 3 SDCM.

- Body made of die-cast aluminum painted.
- Polyester powder coating
- Fixing with steel springs.
- High vacuum metallized pure aluminum reflector.
- Clear tempered glass.
- Cable clamp of nylon 66.
- Led life: 50000 (h) L90 B20.
- Chromatic consistency: 3 SDCM.

	Br	2880-LBC	2881-LBC		17W	2345	500mA	3000	>90
	Br	2880-LBN	2881-LBN		17 W	2530	500mA	4000	>90

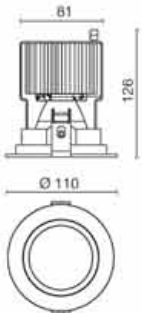

ALIMENTATORI CONSIGLIATI - RECOMMENDED DRIVERS

645085	OF	20W	IP20	500mA
644757	PH	20W	IP20	350/500/900mA
644757-DA	DA	35W	IP40	350/500/900mA

					LED					SISTEMA-SYSTEM			
KIT APPARECCHIO - ALIMENTATORE - FITTING - DRIVER													
ON-OFF													
	Br	KT2880-LBC-OF	KT2881-LBC-OF		17W	2345 2530	220V [500mA]	3000 4000	>90	20W	1950 2103	98 105	
	Br	KT2880-LBN-OF	KT2881-LBN-OF										
DIM 1+10V/PUSH													
	Br	KT2880-LBC-PH	KT2881-LBC-PH		17W	2345 2530	220V [500mA]	3000 4000	>90	20W	1950 2103	98 105	
	Br	KT2880-LBN-PH	KT2881-LBN-PH										
DIM-DALI													
	Br	KT2880-LBC-DA	KT2881-LBC-DA		17W	2345 2530	220V [500mA]	3000 4000	>90	20W	1950 2103	98 105	
	Br	KT2880-LBN-DA	KT2881-LBN-DA										

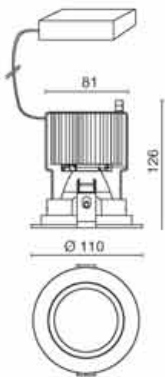

OP. A richiesta - On request: disponibile - available



*Solo apparecchio - Only fitting

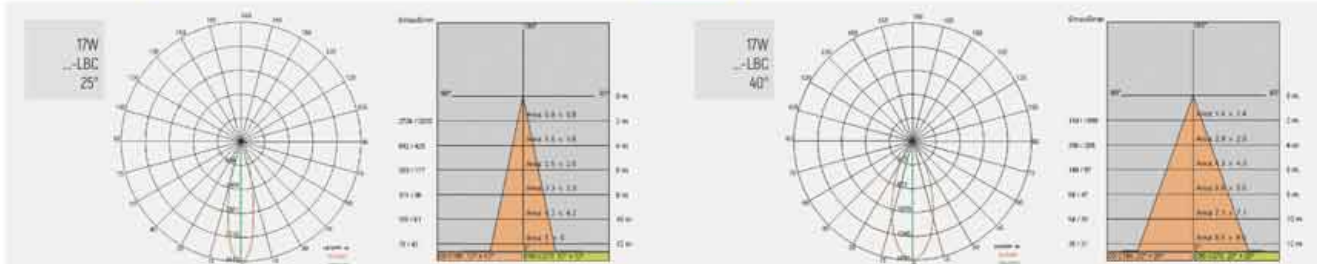

ALIMENTATORI-KIT RGB (se non in dotazione) da ordinare dalla sezione arancio - DRIVERS-RGB KITS (when not supplied) to be ordered from the section orange color





- Corpo in pressofusione di alluminio verniciato.
- Verniciatura in polveri di poliestere.
- Fissaggio tramite molle in acciaio.
- Riflettore in alluminio purissimo, metallizzato in alto vuoto.
- Vetro temprato chiaro.
- Fermacavo in nylon 66.
- Durata nominale: 50000 (h) L90 B20.
- Costanza cromatica: 3 SDCM,

- Body made of painted die-cast aluminum.
- Polyester powder coating
- Fixing with steel springs.
- High vacuum metallized pure aluminum reflector
- Clear tempered glass.
- Cable clamp of nylon 66.
- Led life: 50000 (h) L90 B20.
- Chromatic consistency: 3 SDCM.

SEMIOrientabili - SEMI-ADJUSTABLE



120 mm Δ 1÷30 mm



	15	30	60	W	lm	V	K	CRI
Br 2885-LBC	2886-LBC	2887-LBC	31W	3960	900mA	3000	>90	
Br 2885-LBN	2886-LBN	2887-LBN	31W	4270	900mA	4000	>90	

ALIMENTATORI CONSIGLIATI - RECOMMENDED DRIVERS

646168-I	ON-OFF	36W	IP20	900mA
645384-DA	DALI-PUSH 1÷10V	50W	IP20	900mA

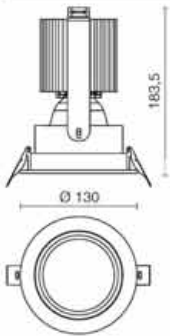

	15	30	60	LED					SISTEMA-SYSTEM			
				W	lm	V	K	CRI	W	lm	W	
KIT APPARECCHIO + ALIMENTATORE - FITTING + DRIVER												
ON-OFF												
Br	KT2885-LBC-OF	KT2886-LBC-OF	KT2887-LBC-OF	31W	3960	220-240V	3000	>90	35W	3478	99	
	KT2885-LBN-OF	KT2886-LBN-OF	KT2887-LBN-OF		4270	[900mA]	4000		3750	107		
DIM-DALI												
Br	KT2885-LBC-DA	KT2886-LBC-DA	KT2887-LBC-DA	31W	3960	220-240V	3000	>90	35W	3478	99	
	KT2885-LBN-DA	KT2886-LBN-DA	KT2887-LBN-DA		4270	[900mA]	4000		3750	107		

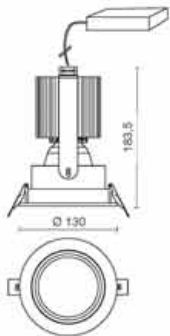

OP. A richiesta - On request: disponibile - available



* Solo apparecchio - Only fitting

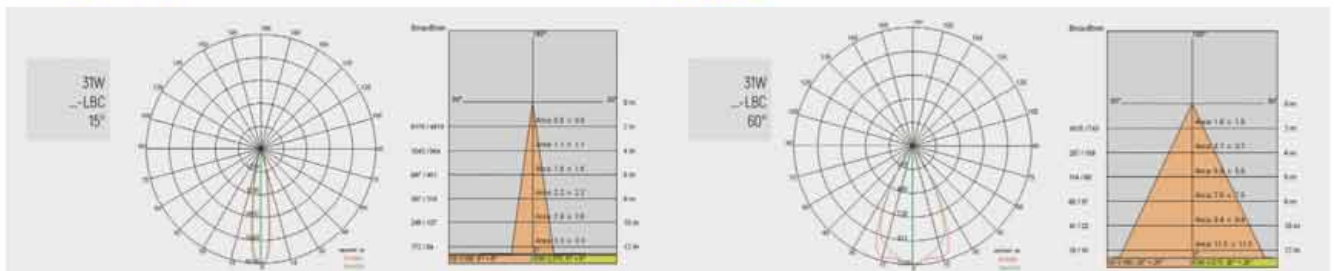
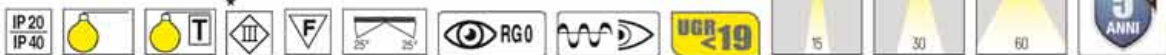

ALIMENTATORI-KIT RGB (se non in dotazione) da ordinare dalla sezione arancio - DRIVERS-RGB KITS (when not supplied) to be ordered from the section orange color

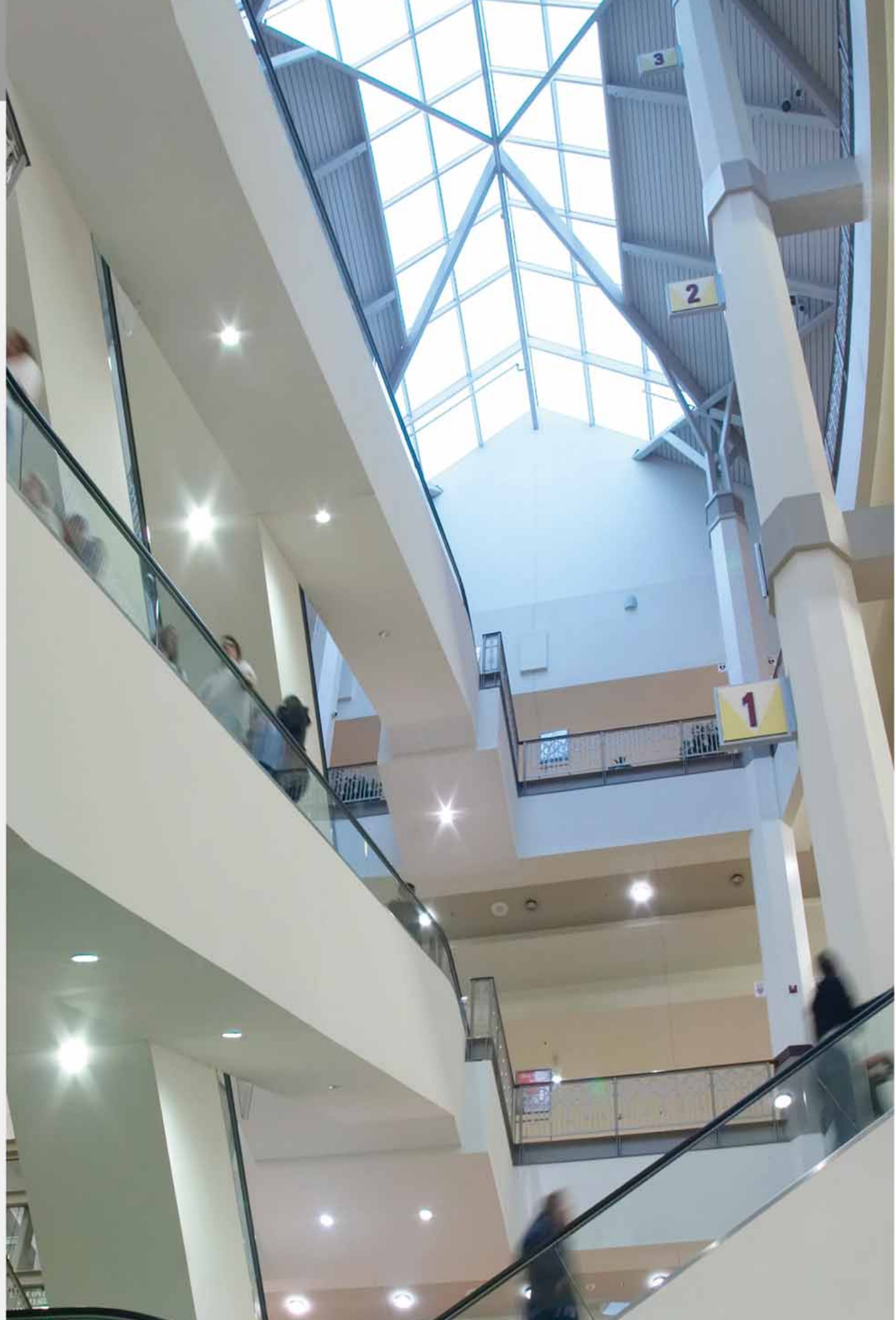

SWING 13 LOW

SEMIORIENTABILI - SEMI-ADJUSTABLE



120 mm 1-30 mm



- Corpo in pressofusione di alluminio verniciato.
- Verniciatura in polveri di poliestere.
- Fissaggio tramite molle in acciaio.
- Riflettore in alluminio purissimo, metallizzato in alto vuoto.
- Vetro temprato chiaro.
- Fermacavo in nylon 66.
- Durata nominale: 50000 [h] L90 B20.
- Costanza cromatic: 3 SDCM.

- Body made of painted die-cast aluminum.
- Polyester powder coating
- Fixing with steel springs.
- High vacuum metallized pure aluminum reflector
- Clear tempered glass.
- Cable clamp of nylon 66.
- Led life: 50000 [h] L90 B20.
- Chromatic consistency: 3 SDCM.

	W	lm	V	K	CRI
Br 2890-LBC	48W	6486	1400mA	3000	>90
Br 2890-LBN	48W	6836	1400mA	4000	>90

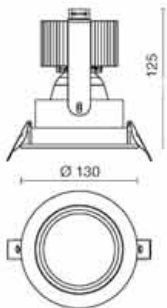

ALIMENTATORI CONSIGLIATI - RECOMMENDED DRIVERS

646168-I	ON-OFF	30W	IP20	900mA
645384-DA	DALI-PUSH 1-10V	50W	IP20	900mA

	LED					SISTEMA-SYSTEM		
	W	lm	V	K	CRI	W	lm	W
KIT APPARECCHIO + ALIMENTATORE - FITTING + DRIVER								
ON-OFF								
Br KT2890-LBC-OF	48W	6486	220-240V	3000	>90	52W	5696	110
Br KT2890-LBN-OF		6836	[1400mA]	4000		6004	115	
DIM-DALI								
Br KT2890-LBC-DA	48W	6486	220-240V	3000	>90	52W	5696	110
Br KT2890-LBN-DA		6836	[1400mA]	4000		6004	115	

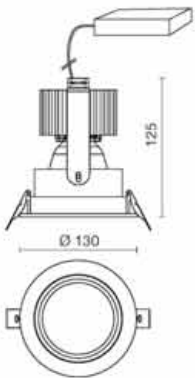

*Solo apparecchio - Only fitting

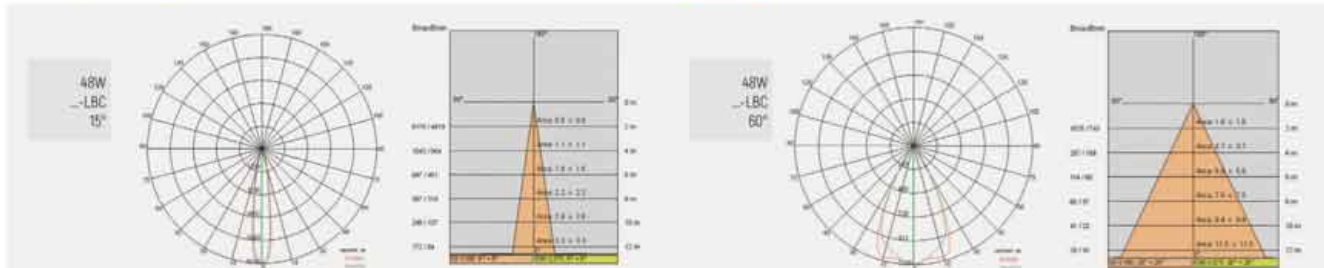

ALIMENTATORI-KIT RGB (se non in dotazione) da ordinare dalla sezione arancio - DRIVERS-RGB KITS (when not supplied) to be ordered from the section orange color

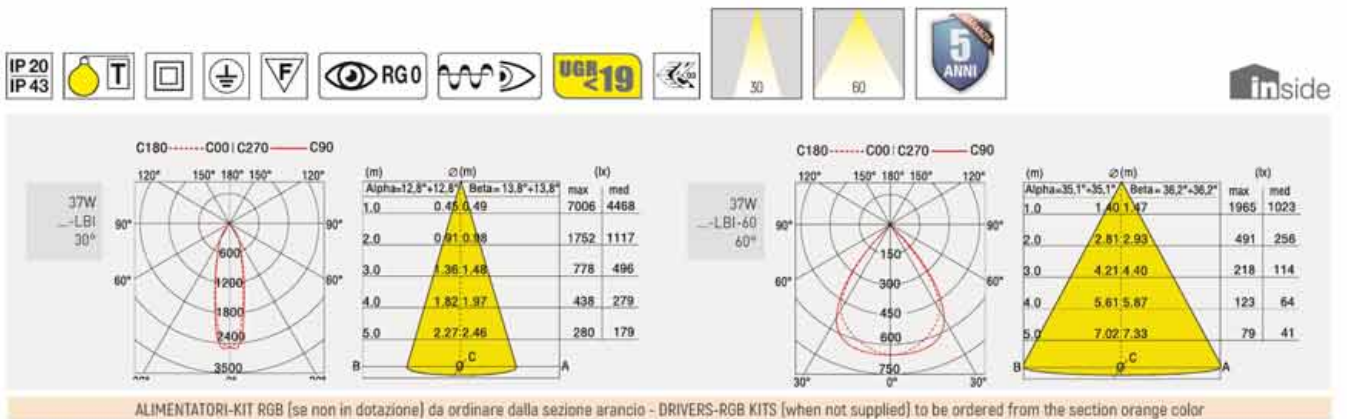



- Anello di finitura esterno in pressofusione di alluminio.
 - Parabola in alluminio purissimo sfaccettata anti-iridescente.
 - Vetro di protezione trasparente.
 - Fissaggio a controsoffitto con staffe regolabili in lamiera zincata.
 - Dissipatore lamellare passivo in alluminio estruso.
 - Alimentatore elettronico esterno in dotazione.
 - Resa cromatica >90
 - Led durata utile: 50.000 (h) L90 B50.
- Die-cast aluminium external finishing ring.
 - Reflector of pure aluminium faceted anti-iridescent.
 - Transparent protection glass.
 - False-ceiling fixing with adjustable brackets made of galvanized sheet.
 - Passive heatsink made of extruded laminated aluminium.
 - Remote electronic driver supplied.
 - CRI >90
 - Led life: 50.000 (h) L90 B50.



156 mm 0±30 mm

	Br	Ga	LED					SISTEMA-SYSTEM		
			W	lm	V	K	CRI	W	lm	$\frac{lm}{W}$
□	Br 57550-LBC	57550-LBC-60	24W	3365	220-240V [700mA]	3000	>90	27W	3284	122
	Ga 57551-LBC	57551-LBC-60								
□	Br 57550-LBI	57550-LBI-60	24W	3570	220-240V [700mA]	4000	>90	27W	3484	129
	Ga 57551-LBI	57551-LBI-60								
□	Br 57552-LBC	57552-LBC-60	37W	4740	220-240V [1050mA]	3000	>90	41W	4626	113
	Ga 57553-LBC	57553-LBC-60								
□	Br 57552-LBI	57552-LBI-60	37W	4870	220-240V [1050mA]	4000	>90	41W	4851	118
	Ga 57553-LBI	57553-LBI-60								
versione-version P L U S										
⊕	Br 57580-LBC-30	57580-LBC-60	43W	5280	220-240V [1200mA]	3000	>90	47W	4896	104
	Ga 57581-LBC-30	57581-LBC-60								
⊕	Br 57580-LBI-30	57580-LBI-60	43W	5520	220-240V [1200mA]	4000	>90	47W	4983	106
	Ga 57581-LBI-30	57581-LBI-60								
 DALI DIM-DALI/PUSH										
□	Br 57550LBC-DA	57550LBC60-DA	24W	3365	220-240V [700mA]	3000	>90	27W	3116	115
	Ga 57551LBC-DA	57551LBC60-DA								
□	Br 57550LBI-DA	57550LBI60-DA	24W	3570	220-240V [700mA]	4000	>90	27W	3306	122
	Ga 57551LBI-DA	57551LBI60-DA								
□	Br 57552LBC-DA	57552LBC60-DA	37W	4740	220-240V [1050mA]	3000	>90	41W	4626	112
	Ga 57553LBC-DA	57553LBC60-DA								
□	Br 57552LBI-DA	57552LBI60-DA	37W	4870	220-240V [1050mA]	4000	>90	41W	4567	111
	Ga 57553LBI-DA	57553LBI60-DA								
versione-version P L U S										
⊕	Br 57580LBC30-DA	57580LBC60-DA	43W	5280	220-240V [1200mA]	3000	>90	47W	4852	103
	Ga 57581LBC30-DA	57581LBC60-DA								
⊕	Br 57580LBI30-DA	57580LBI60-DA	43W	5520	220-240V [1200mA]	4000	>90	47W	5073	108
	Ga 57581LBI30-DA	57581LBI60-DA								

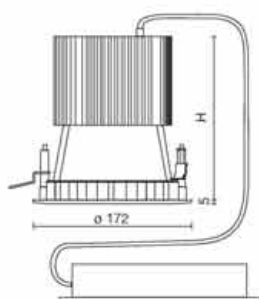

H pot. 27W = 122mm
pot. 41W = 184mm
pot. 47W = 184mm

sigl.
1,50

OP. A richiesta - On request: Led con temperatura di COLORE 2700K - Temperature Led COLOUR 2700K

Versione in emergenza SA (sempre acceso): Autonomia 1h - Flusso luminoso 20%
Version for SA (always on): Working time 1h - Luminous flux 20%

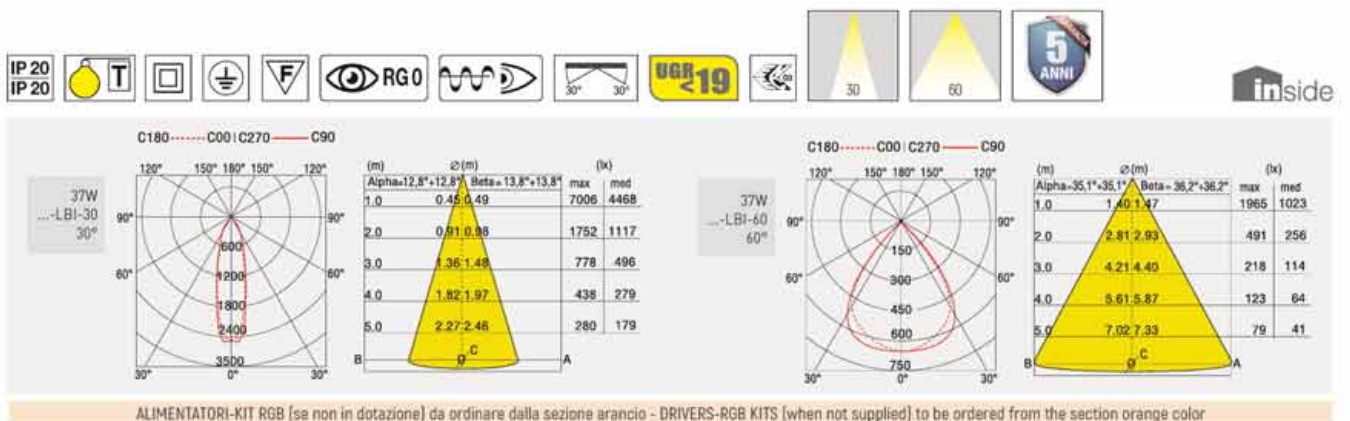
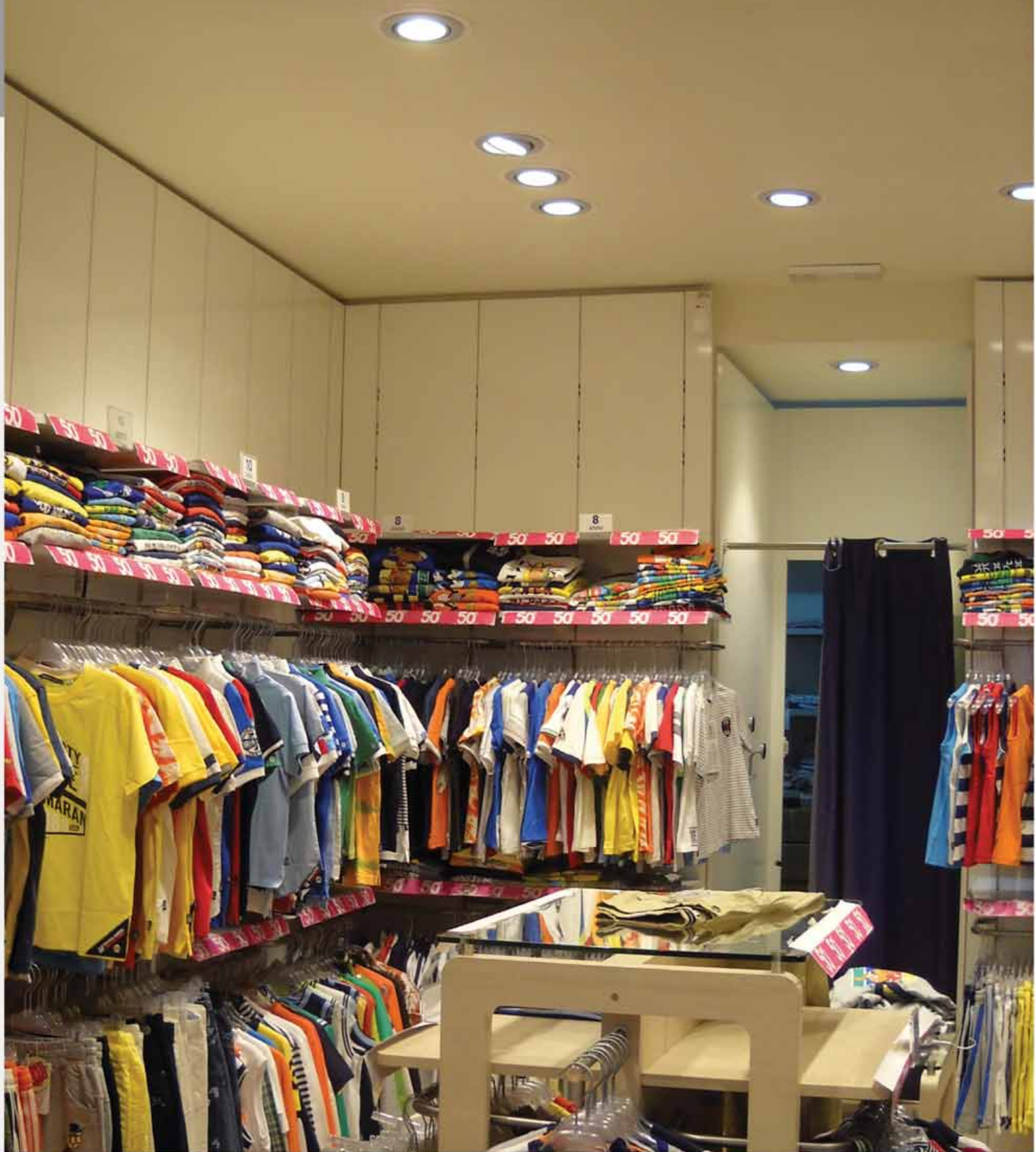



NET MCL ORIENTABILE



156 mm Ø = 20 mm



- Anello di finitura esterno in pressofusione di alluminio.
 - Parabola in alluminio purissimo sfaccettata anti-iridescente.
 - Vetro di protezione trasparente.
 - Fissaggio a controsoffitto con staffe regolabili in lamiera zincata.
 - Dissipatore lamellare passivo in alluminio estruso.
 - Alimentatore elettronico esterno in dotazione.
 - Resa cromatica >90
 - Led durata utile: 50.000 [h] L90 B50.
-
- Die-cast aluminium external finishing ring.
 - Reflector of pure aluminium faceted anti-iridescent.
 - Transparent protection glass.
 - False-ceiling fixing with adjustable brackets made of galvanized sheet.
 - Passive heatsink made of extruded aluminium.
 - Remote electronic driver supplied.
 - CRI >90
 - Led life: 50.000 [h] L90 B50.

	Icona	30	60	LED					SISTEMA-SYSTEM		
				W	lm	V	K	CRI	W	lm	lm/W
□	Br	57554-LBC-30	57554-LBC-60	24W	3365	220-240V [700mA]	3000	>90	27W	2689	99
	Ga	57555-LBC-30	57555-LBC-60								
□	Br	57554-LBI-30	57554-LBI-60	24W	3570	220-240V [700mA]	4000	>90	27W	2852	106
	Ga	57555-LBI-30	57555-LBI-60								
□	Br	57556-LBC-30	57556-LBC-60	37W	4740	220-240V [1050mA]	3000	>90	41W	4304	105
	Ga	57557-LBC-30	57557-LBC-60								
□	Br	57556-LBI-30	57556-LBI-60	37W	4970	220-240V [1050mA]	4000	>90	41W	4513	110
	Ga	57557-LBI-30	57557-LBI-60								
Versione-versione PLUS											
□	Br	57585-LBC-30	57585-LBC-60	43W	5280	220-240V [1200mA]	3000	>90	47W	4896	104
	Ga	57586-LBC-30	57586-LBC-60								
□	Br	57585-LBI-30	57585-LBI-60	43W	5520	220-240V [1200mA]	4000	>90	47W	4982	106
	Ga	57586-LBI-30	57586-LBI-60								
DALI DIM-DALI/PUSH											
□	Br	57554LBC30-DA	57554LBC60-DA	24W	3365	220-240V [700mA]	3000	>90	27W	3011	112
	Ga	57555LBC30-DA	57555LBC60-DA								
□	Br	57554LBI30-DA	57554LBI60-DA	24W	3570	220-240V [700mA]	4000	>90	27W	3194	118
	Ga	57555LBI30-DA	57555LBI60-DA								
□	Br	57556LBC30-DA	57556LBC60-DA	37W	4740	220-240V [1050mA]	3000	>90	41W	4241	103
	Ga	57557LBC30-DA	57557LBC60-DA								
□	Br	57556LBI30-DA	57556LBI60-DA	37W	4970	220-240V [1050mA]	4000	>90	41W	4447	108
	Ga	57557LBI30-DA	57557LBI60-DA								
Versione-versione PLUS											
□	Br	57585LBC30-DA	57585LBC60-DA	43W	5280	220-240V [1200mA]	3000	>90	47W	4510	96
	Ga	57586LBC30-DA	57586LBC60-DA								
□	Br	57585LBI30-DA	57585LBI60-DA	43W	5520	220-240V [1200mA]	4000	>90	47W	4715	100
	Ga	57586LBI30-DA	57586LBI60-DA								

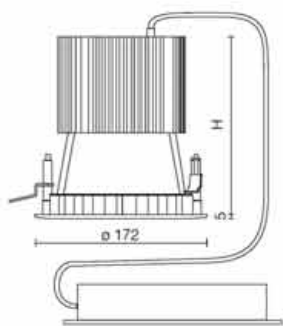

H pot. 27W = 122mm
 pot. 41W = 184mm
 pot. 47W = 184mm



OP. A richiesta - On request: Led con temperatura di COLORE 2700K - Temperature Led COLOUR 2700K

Versione in emergenza SA (sempre acceso): Autonomia 1h - Flusso luminoso 20%
 Version for SA (always on): Working time 1h - Luminous flux 20%

ACC. A richiesta: versione in emergenza aggiungendo il Kit - On request: emergency version adding Kit

INV 1052 Kit 1h
 INV 1052-3 Kit 3h



inside

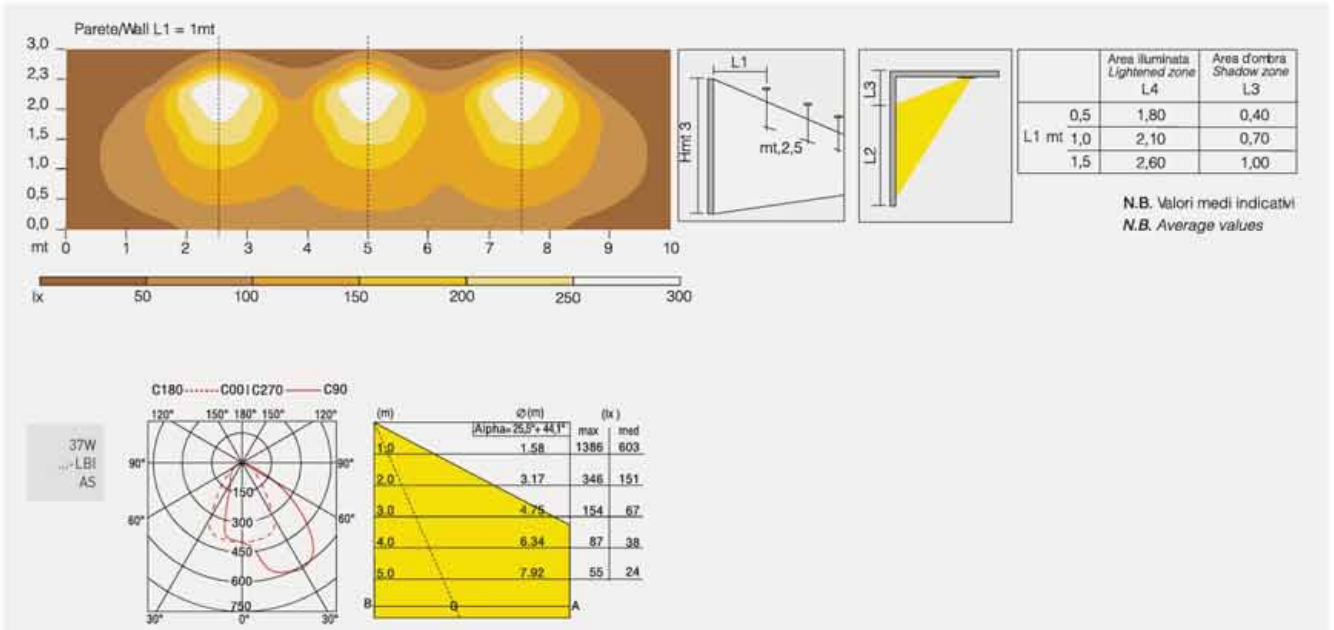



NET ASYMMETRIC MCL

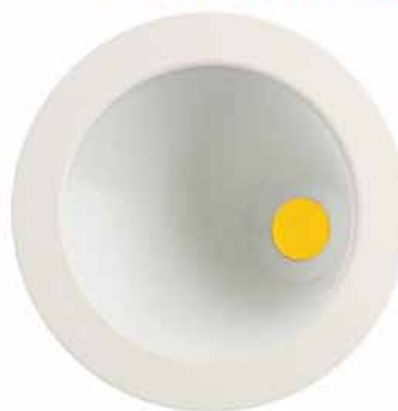

156 mm 0+30 mm

- Anello di finitura esterno in pressofusione di alluminio.
 - Parabola in materiale termoplastico.
 - Vetro di protezione trasparente.
 - Fissaggio a controsoffitto con staffe regolabili in lamiera zincata.
 - Dissipatore lamellare passivo in alluminio estruso.
 - Alimentatore elettronico esterno in dotazione.
 - Led durata utile: 50.000 (h) L90 B50.
- Die-cast aluminium external finishing ring.
 - Reflector made of thermoplastic material.
 - Transparent protection glass.
 - False-ceiling fixing with adjustable brackets made of galvanized sheet.
 - Passive heatsink made of extruded aluminium.
 - Remote electronic driver supplied.
 - Led life: 50.000 (h) L90 B50.

		LED					SISTEMA-SYSTEM		
		W	lm	V	K	CRI	W	lm	W
	Br 57550AS-LBC Ga 57551AS-LBC	24W	3365	220-240V [700mA]	3000	>90	27W	2608	96
	Br 57550AS-LBI Ga 57551AS-LBI	24W	3570	220-240V [700mA]	4000	>90	27W	2767	102
	Br 57552AS-LBC Ga 57553AS-LBC	37W	4740	220-240V [1050mA]	3000	>90	41W	3673	90
	Br 57552AS-LBI Ga 57553AS-LBI	37W	4970	220-240V [1050mA]	4000	>90	41W	3851	94
versione-version P L U S									
	Br 57580AS-LBC Ga 57581AS-LBC	43W	5280	220-240V [1200mA]	3000	>90	47W	4052	86
	Br 57580AS-LBI Ga 57581AS-LBI	43W	5520	220-240V [1200mA]	4000	>90	47W	4039	86
DIM-DALI/PUSH									
	Br 57550ASLBC-DA Ga 57551ASLBC-DA	24W	3365	220-240V [700mA]	3000	>90	27W	2608	96
	Br 57550ASLBI-DA Ga 57551ASLBI-DA	24W	3590	220-240V [700mA]	4000	>90	27W	2767	102
	Br 57552ASLBC-DA Ga 57553ASLBC-DA	37W	4740	220-240V [1050mA]	3000	>90	41W	3673	90
	Br 57552ASLBI-DA Ga 57553ASLBI-DA	37W	4970	220-240V [1050mA]	4000	>90	41W	3851	94
versione-version P L U S									
	Br 57580ASLBC-DA Ga 57581ASLBC-DA	43W	5280	220-240V [1200mA]	3000	>90	47W	4092	87
	Br 57580ASLBI-DA Ga 57581ASLBI-DA	43W	5520	220-240V [1200mA]	4000	>90	47W	4278	91

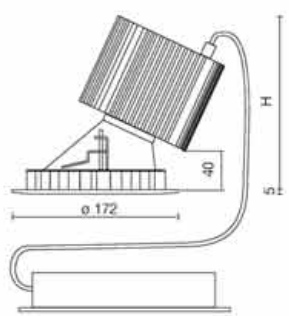

H pot. 27W = 122mm
 pot. 41W = 184mm
 pot. 47W = 184mm

OP. A richiesta - On request: Led con temperatura di COLORE 2700K - Temperature Led COLOUR 2700K

Versione in emergenza SA (sempre acceso). Autonomia 1h - Flusso luminoso 20%
 Version for SA (always on). Working time 1h - Luminous flux 20%

ACC. A richiesta: versione in emergenza aggiungendo il Kit - On request: emergency version adding Kit
 INV 1052 Kit 1h
 INV 1052-3 Kit 3h

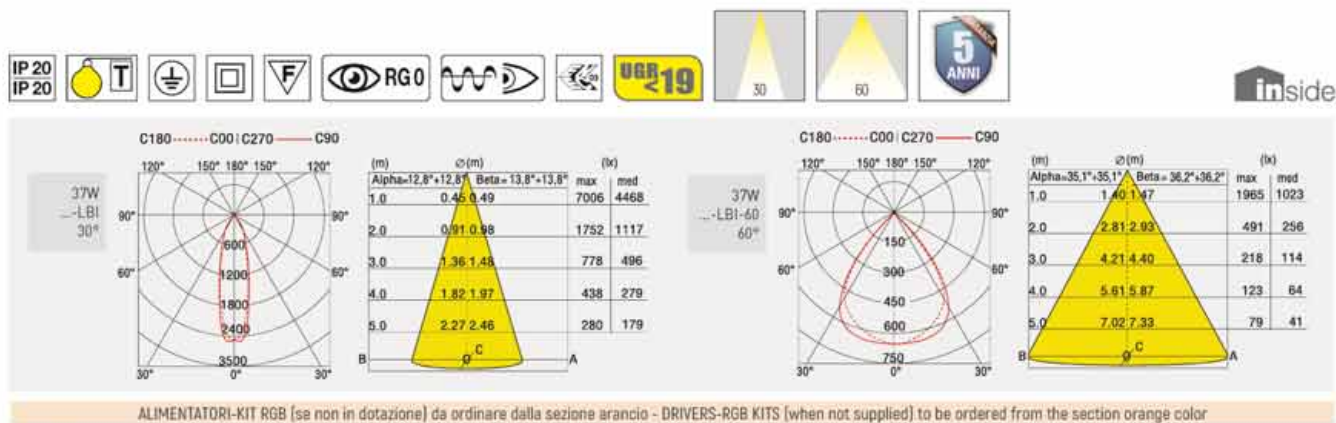



- Versione per installazione a rasamento per controsoffitti in cartongesso.
- Parabola in alluminio purissimo sfaccettata anti-iridescente.
- Fissaggio a controsoffitto con staffe regolabili in lamiera zincata.
- Dissipatore lamellare passivo in alluminio estruso.
- Alimentatore elettronico esterno in dotazione.
- Led durata utile: 50.000 [h] L90 B50.

- Version for installation at the same level of the false-ceiling made of soft-wall.
- Reflector of pure aluminium faceted anti-iridescent.
- False-ceiling fixing with adjustable brackets made of galvanized sheet.
- Passive heatsink made of extruded aluminium.
- Remote electronic driver supplied.
- Led life: 50.000 [h] L90 B50.

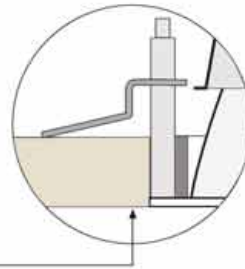

Controsoffitto in cartongesso
False-ceiling made of plasterboard



156 mm 0+30 mm

	Br	57550R-LBC	57550R-LBI	57550R-LBC-60	57550R-LBI-60	LED					SISTEMA-SYSTEM		
						W	lm	V	K	CRI	W	lm	W
□	Br	57550R-LBC	57550R-LBI	57550R-LBC-60	57550R-LBI-60	24W	3365	220-240V	3000	>90	27W	3284	129
							3570	(700mA)	4000			3484	122
□	Br	57552R-LBC	57552R-LBI	57552R-LBC-60	57552R-LBI-60	37W	4740	220-240V	3000	>90	41W	4262	113
							4970	(1050mA)	4000			4851	118
versione-version P L U S													
⊕	Br	57580R-LBC-30	57580R-LBI-30	57580R-LBC-60	57580R-LBI-60	43W	5280	220-240V	3000	>90	47W	4896	104
							5520	(1200mA)	4000			4982	106
DALI DIM-DALI/PUSH													
□	Br	57550RLBC-DA	57550RLBI-DA	57550RLBC60-DA	57550RLBI60-DA	24W	3365	220-240V	3000	>90	27W	3284	129
							3570	(700mA)	4000			3484	122
□	Br	57552RLBC-DA	57552RLBI-DA	57552RLBC60-DA	57552RLBI60-DA	37W	4740	220-240V	3000	>90	41W	4262	113
							4970	(1050mA)	4000			4851	118
versione-version P L U S													
⊕	Br	57580RLBC3-DA	57580RLBI3-DA	57580RLBC6-DA	57580RLBI6-DA	43W	5280	220-240V	3000	>90	47W	4896	104
							5520	(1200mA)	4000			4982	106

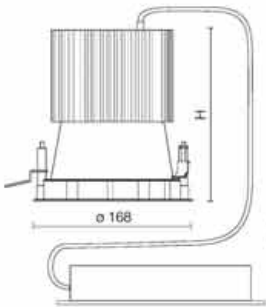

H pot. 27W = 122mm
pot. 41W = 184mm
pot. 47W = 184mm

OP. A richiesta - On request: Led con temperatura di COLORE 2700K - Temperature Led COLOUR 2700K

Versione in emergenza SA (sempre acceso): Autonomia 1h - Flusso luminoso 20%
Version for SA (always on): Working time 1h - Luminous flux 20%

ACC. A richiesta, versione in emergenza aggiungendo il Kit - On request: emergency version adding Kit

INV 1052 Kit 1h
INV 1052-3 Kit 3h



BEND MINI INCASSO

- Corpo e vano ottico in pressofusione di alluminio.
- Verniciatura in polveri di poliestere.
- Riflettore in policarbonato metallizzato a specchio.
- Led durata utile: 50.000 (h) L80 B20.
- Consistenza cromatica: 3 SDCM.

- Housing made of die-cast aluminum.
- Polyester powder coating
- Mirror metallized polycarbonate reflector.
- Led life: 50.000 (h) L80 B20.
- Chromatic consistency: 3 SDCM.



60 mm Δ 1+30 mm

	Br	67395-LBC-20M	67395-LBC-40M	LED					SISTEMA-SYSTEM			
				W	lm	V	K	CRI	W	lm	lm/W	Beam
	Ne	67396-LBC-20M	67396-LBC-40M	12,4W	1580	220-240V (350mA)	3000	>90	14,4W	1390	97	[20°]
	Br	67395-LBN-20M	67395-LBN-40M	12,4W	1650	220-240V (350mA)	4000	>90	14,4W	1450	97	[20°]
	Ne	67396-LBN-20M	67396-LBN-40M						14,4W	1335	107	[40°]

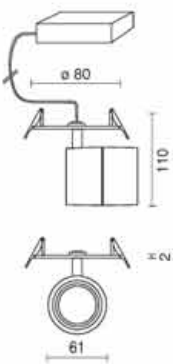

* In fase di approvazione - Under approval

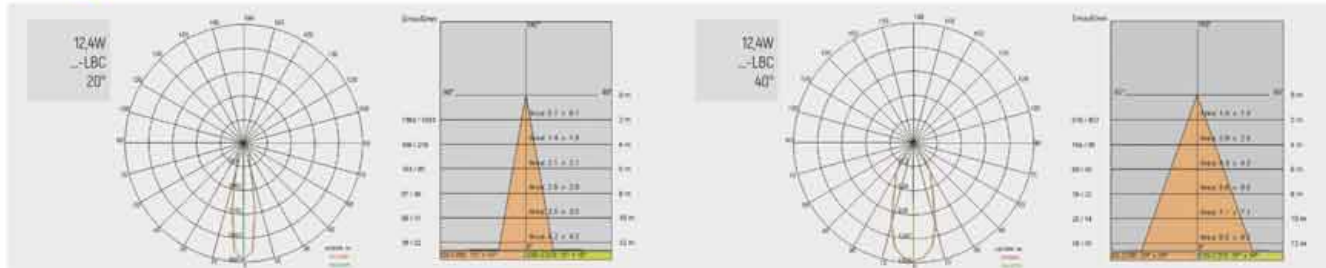

ALIMENTATORI-KIT RGB (se non in dotazione) da ordinare dalla sezione arancio - DRIVERS-RGB KITS (when not supplied) to be ordered from the section orange color

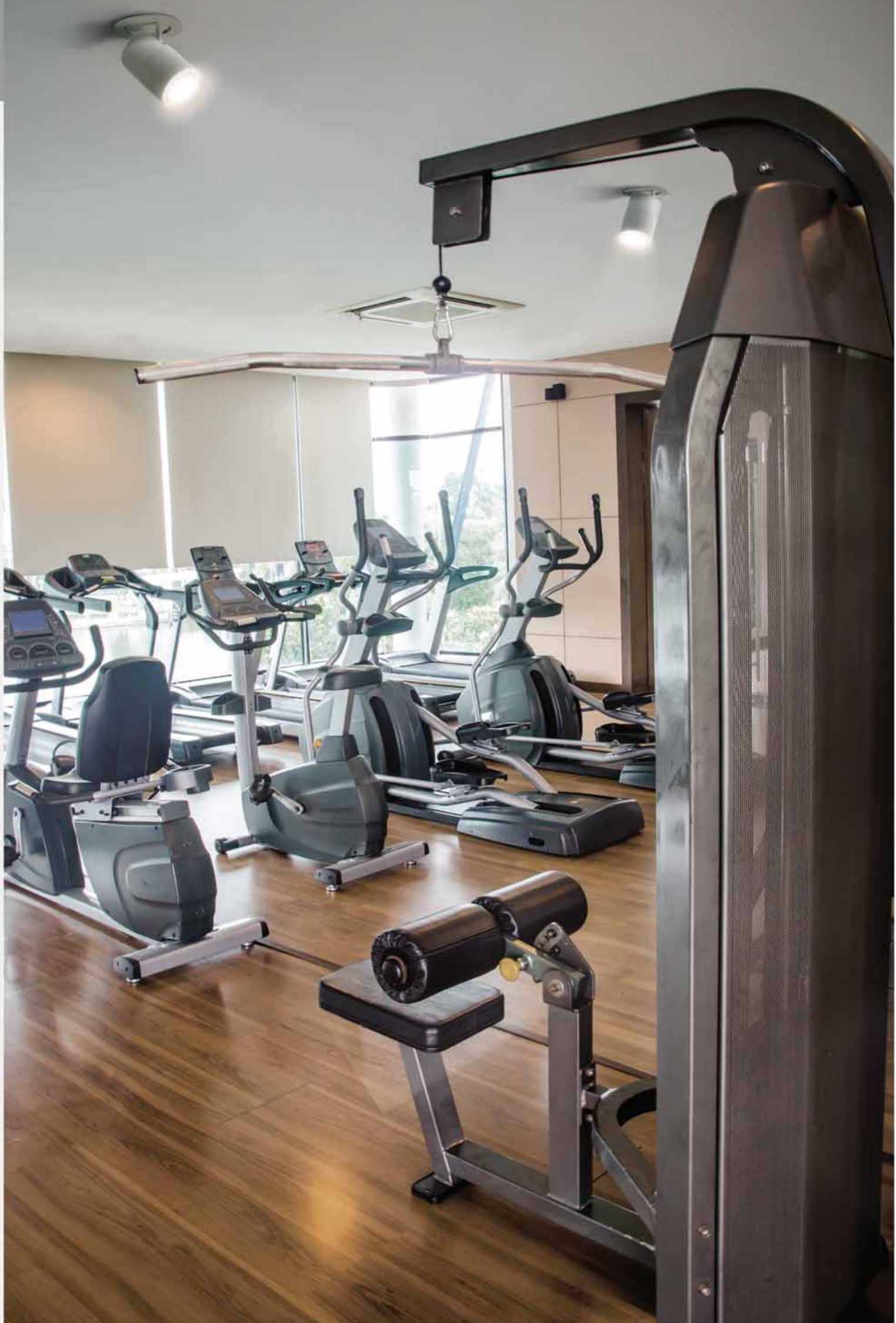



BEND XS ESTRAIBILE-ORIENTABILE

- Corpo e vano ottico in pressofusione di alluminio verniciato.
- Alimentatore elettronico.
- Vetro di protezione.
- Riflettore in alluminio purissimo, metallizzato in alto vuoto.
- Led durata utile: 50.000 (h) L90 B20.
- Consistenza cromatica: 3 SDCM.

- Housing and optic tray made of powder coated die-cast aluminium.
- Electronic driver.
- Protection glass.
- High purity aluminium reflector, high vacuum metallized.
- Led life: 50.000 (h) L90 B20.
- Chromatic consistency: 3 SDCM.



125 mm $\Delta = 5+30$ mm

	Br	Ne	Gr	LED					SYSTEM-SYSTEM		
				W	lm	V	K	CRI	W	lm	lm/W
	68035-LBC-25	68035-LBC-40		24W	3365	220-240V (700mA)	3000	>90	27W	2793	103
	68036-LBC-25	68036-LBC-40									
	68037-LBC-25	68037-LBC-40									
	68035-LBN-25	68035-LBN-40		24W	3570	220-240V (700mA)	4000	>90	27W	2963	110
	68036-LBN-25	68036-LBN-40									
	68037-LBN-25	68037-LBN-40									
	68035LBC25-DA	68035LBC40-DA		24W	3365	220-240V (700mA)	3000	>90	27W	2793	103
	68036LBC25-DA	68036LBC40-DA									
	68037LBC25-DA	68037LBC40-DA									
	68035LBN25-DA	68035LBN40-DA		24W	3570	220-240V (700mA)	4000	>90	27W	2963	110
	68036LBN25-DA	68036LBN40-DA									
	68037LBN25-DA	68037LBN40-DA									

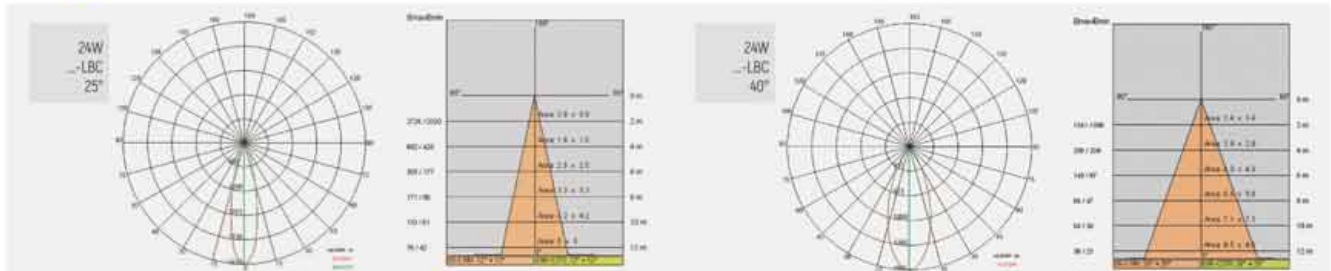

ALIMENTATORI-KIT RGB (se non in dotazione) da ordinare dalla sezione arancio - DRIVERS-RGB KITS (when not supplied) to be ordered from the section orange color





BEND XS ESTRAIBILE-ORIENTABILE FLANGIA QUADRATA

- Dimensione flangia quadrata: 132x132mm magnetica.
- Viti in dotazione.
- Corpo ottica in pressofusione di alluminio EN AB-47100, struttura in lamiera di acciaio.
- Verniciatura per interni in polvere poliestere.
- Riflettore in alluminio purissimo 99,9% - ottica estraibile orientabile.
- Vetro temprato chiaro.
- Alimentatore integrato per Led, uscita stabilizzata 700mA dc.
- Led durata utile: 50.000 (h) L90 B20.
- Consistenza cromatica: 3 SDCM.

- Dimensions of the magnetic square flange: 132x132mm.
- Supplied screws.
- Optic body in EN AB-47100 die-cast aluminium, steel sheet structure.
- Polyester powder coating for indoor use.
- Reflector in pure aluminum 99.9% adjustable pull-out optic.
- Clear tempered glass.
- Integrated power supply for LED, stabilized output 700mA dc.
- Led service life: 50,000 (h) L90 B20.
- Chromatic consistency: 3 SDCM.



125 mm $\Delta = 5 \pm 30$ mm

	Br	Ne	Gr	LED					SISTEMA-SYSTEM		
				W	lm	V	K	CRI	W	lm	lm/W
	68038-LBC-25	68038-LBC-40		24W	3365	220-240V (700mA)	3000	>90	27W	2793	103
	68039-LBC-25	68039-LBC-40									
	68040-LBC-25	68040-LBC-40									
	68038-LBN-25	68038-LBN-40		24W	3570	220-240V (700mA)	4000	>90	27W	2963	110
	68039-LBN-25	68039-LBN-40									
	68040-LBN-25	68040-LBN-40									
DALI DIM-DALI/PUSH											
	68038LBC25-DA	68038LBC40-DA		24W	3365	220-240V (700mA)	3000	>90	27W	2793	103
	68039LBC25-DA	68039LBC40-DA									
	68040LBC25-DA	68040LBC40-DA									
	68038LBN25-DA	68038LBN40-DA		24W	3570	220-240V (700mA)	4000	>90	27W	2963	110
	68039LBN25-DA	68039LBN40-DA									
	68040LBN25-DA	68040LBN40-DA									

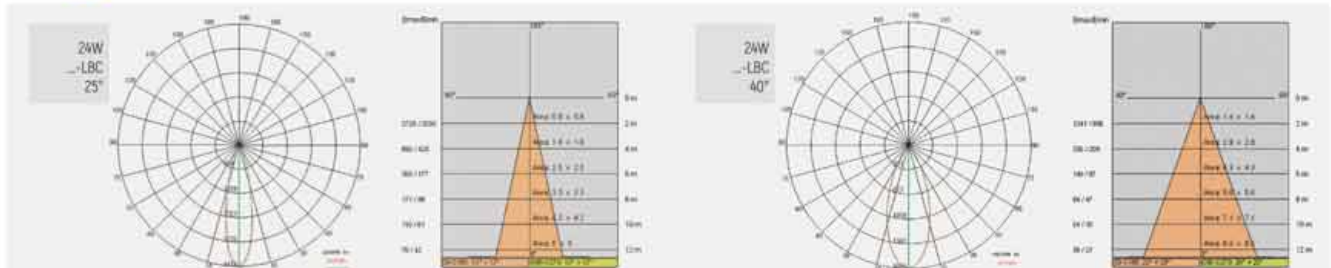

ALIMENTATORI-KIT RGB (se non in dotazione) da ordinare dalla sezione arancio - DRIVERS-RGB KITS (when not supplied) to be ordered from the section orange color





BEND XS ESTRAIBILE-ORIENTABILE FLANGIA RETTANGOLARE

- Dimensione flangia rettangolare: 268x136x6mm magnetica.
- Viti in dotazione.
- Corpo ottica in pressofusione di alluminio EN AB-47100, struttura in lamiera di acciaio.
- Verniciatura per interni in polvere poliestere.
- Riflettore in alluminio purissimo 99,9% - ottica estraibile orientabile.
- Vetro temprato chiaro.
- Alimentatore integrato per Led, uscita stabilizzata 700mA dc.
- Led durata utile: 50.000 (h) L90 B20.
- Consistenza cromatica: 3 SDCM.

- Dimensions of the magnetic rectangular flange: 268x136x6mm.
- Supplied screws.
- Optic body in EN AB-47100 die-cast aluminium, steel sheet structure.
- Polyester powder coating for indoor use.
- Reflector in pure aluminium 99.9% adjustable pull-out optic.
- Clear tempered glass.
- Integrated power supply for LED diodes, stabilized output @700mA dc.
- Led service life: 50,000 (h) L90 B20.
- Chromatic consistency: 3 SDCM.



254x118 mm ▲ 5+30 mm

	Br	Ne	Gr	LED		V	K	CRI	SYSTEM-SYSTEM		
				W	lm				W	lm	lm/W
	68041-LBC-25	68041-LBC-40		2x24W	2x3365	220-240V (700mA)	3000	>90	51W	5586	110
	68042-LBC-25	68042-LBC-40		2x24W	2x3570	220-240V (700mA)	4000	>90	51W	5926	116
	68043-LBC-25	68043-LBC-40		2x24W	2x3570	220-240V (700mA)	4000	>90	51W	5926	116
	68041LBC25-DA	68041LBC40-DA		2x24W	2x3365	220-240V (700mA)	3000	>90	51W	5586	110
	68042LBC25-DA	68042LBC40-DA		2x24W	2x3570	220-240V (700mA)	4000	>90	51W	5926	116
	68043LBC25-DA	68043LBC40-DA		2x24W	2x3570	220-240V (700mA)	4000	>90	51W	5926	116



inside

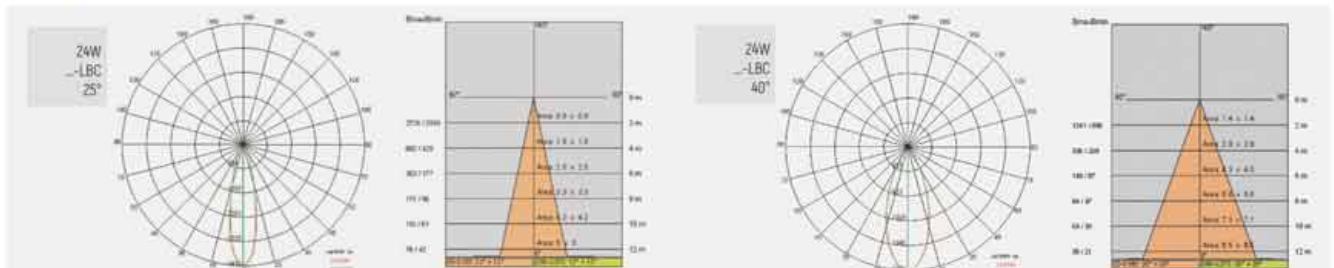

ALIMENTATORI-KIT RGB (se non in dotazione) da ordinare dalla sezione arancio - DRIVERS-RGB KITS (when not supplied) to be ordered from the section orange color





- Corpo in pressofusione di alluminio verniciato.
- Verniciatura in polveri di poliestere.
- Vetro temperato trasparente extrachiaro.
- Led durata utile: 50.000 (h) L90 B20.

- Body made of painted die-cast aluminum.
- Polyester powder coating
- Extra clear tempered glass.
- Led life: 50.000 (h) L90 B20.

LUCE D'ACCENTO – ACCENT DOWNLIGHTERS
PERFORMANCE
TOR 15 MCL ORIENTABILE



156 mm 5÷30 mm

				LED					SISTEMA-SYSTEM			
				W	lm	V	K	CRI	W	lm	W	°
Bi	2929C-LBC-S	SPOT	10	30,5W	4270	220-240V [900mA]	3000	>90	35W	3802	109	(15°)
	2929C-LBC-FL	FLOOD	30							3602	103	(30°)
	2929C-LBC-WF	WIDE FLOOD	40							3644	104	(40°)
Bi	2929C-LBN-S	SPOT	10	30,5W	4600	220-240V [900mA]	4000	>90	35W	4097	117	(15°)
	2929C-LBN-FL	FLOOD	30							3880	111	(30°)
	2929C-LBN-WF	WIDE FLOOD	40							3926	112	(40°)

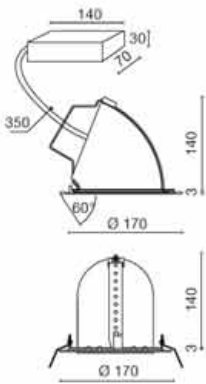

OP. A richiesta - On request: Led con temperatura di COLORE 2700K - Temperature Led COLOUR 2700K
disponibile - available

ACC. A richiesta: versione in emergenza aggiungendo il Kit - On request: emergency version adding Kit
INV 1052 Kit 1h
INV 1052-3 Kit 3h

122 Anello di compensazione - Compensation ring

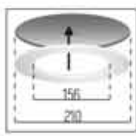

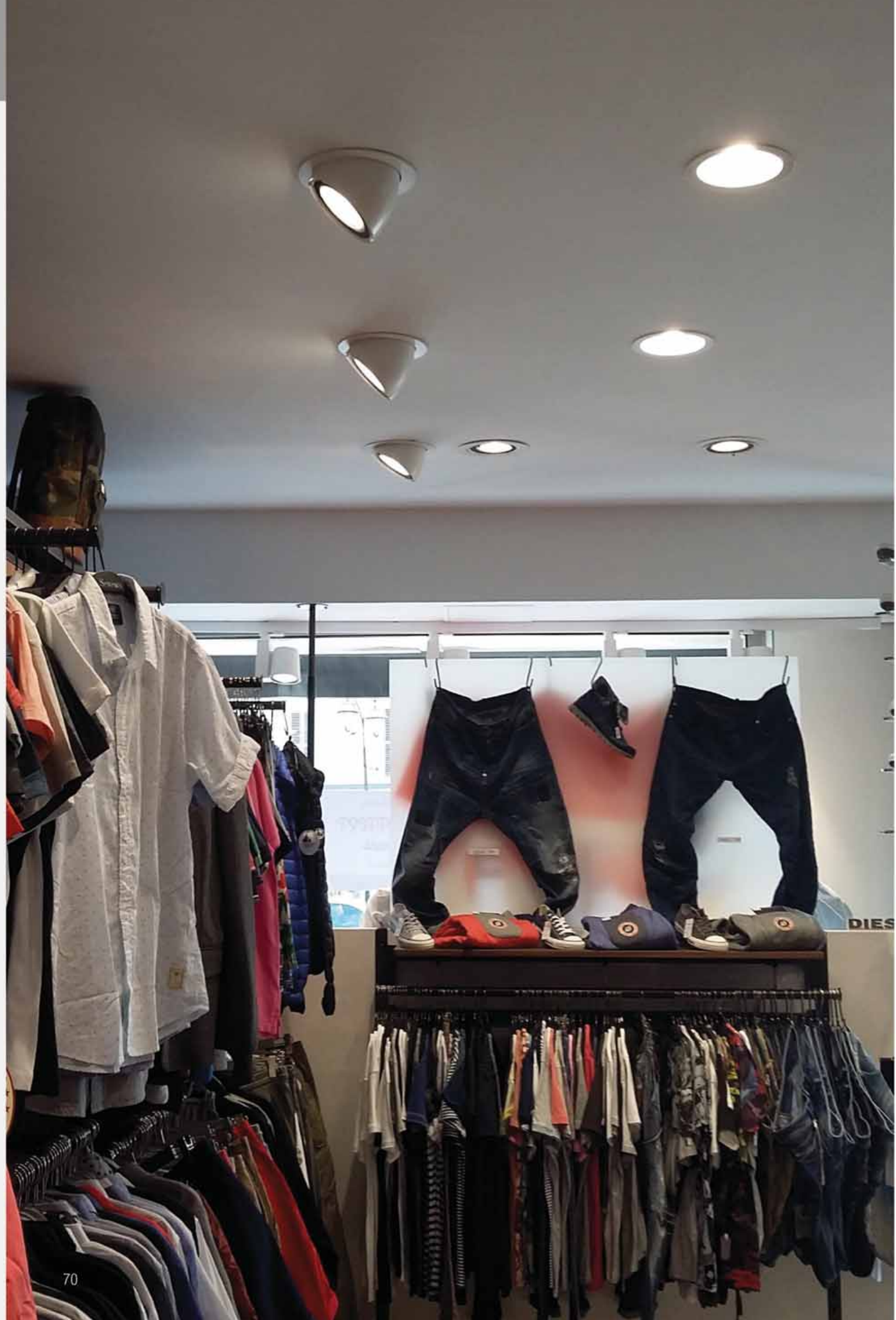



TOR 18 MCL ORIENTABILE



205 mm 5+30 mm

- Corpo in pressofusione di alluminio.
- Verniciatura in polveri di poliestere.
- Parabola in alluminio purissimo al 99,8%.
- Vetro temperato trasparente extrachiaro.
- Led durata utile: 50.000 (h) L90 B20.

- Housing and ring of die-cast aluminium.
- Polyester powder coating
- Reflector of very pure aluminium 99,8%.
- Extra clear tempered glass.
- Led life: 50.000 (h) L90 B20.

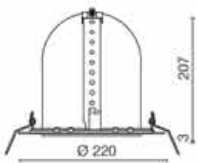
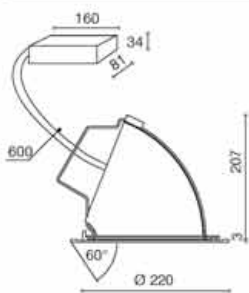

240

				LED					SISTEMA-SYSTEM			
				W	lm	V	K	CRI	W	lm	IP	
Br	2985-LBC	2988-LBC	2991-LBC	24W	3180	220-240V [700mA]	3000	>90	27W	2930	109	[20°]
Ne	2986-LBC	2989-LBC	2992-LBC							2930	109	[30°]
Gr	2987-LBC	2990-LBC	2993-LBC							2930	109	[60°]
Br	2985-LBN	2988-LBN	2991-LBN	24W	3430	220-240V [700mA]	4000	>90	27W	3160	117	[20°]
Ne	2986-LBN	2989-LBN	2992-LBN							3160	117	[30°]
Gr	2987-LBN	2990-LBN	2993-LBN							3160	117	[60°]

OP. A richiesta - On request: Led con temperatura di COLORE 2700K - Temperature Led COLOUR 2700K
disponibile - available



ACC. A richiesta: versione in emergenza aggiungendo il Kit - On request: emergency version adding Kit
INV 1052 Kit 1h
INV 1052-3 Kit 3h





IP 20 IP 44

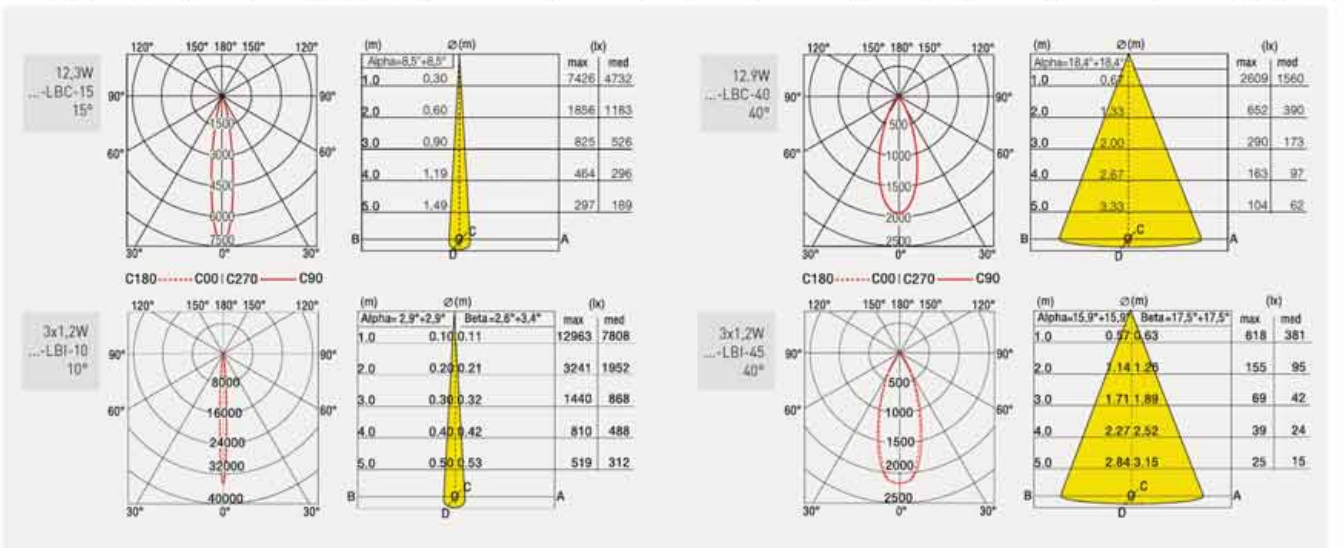

ALIMENTATORI-KIT RGB (se non in dotazione) da ordinare dalla sezione arancio - DRIVERS-RGB KITS (when not supplied) to be ordered from the section orange color



SPRINT MINI



105 mm 0+30 mm

- Struttura in lamiera verniciata a polvere e molle di fissaggio a filo.
- Sorgente luminosa ad alta resa completo di dissipatore in alluminio verniciato.
- Painted steel powder coated body and lock spring at flat level.
- High efficiency source with painted aluminium heatsink.

LED COB				(W)	(lm)	(V)	(K)		(CRI)
	Br	67915C-LBC-15							
	Ne	67916C-LBC-15	15	12,3W	1040	350mA	3000		>90
	Ga	67917C-LBC-15							
	Br	67915C-LBN-15							
	Ne	67916C-LBN-15	15	12,3W	1120	350mA	4000		>90
	Ga	67917C-LBN-15							
	Br	67915C-LBC-24							
	Ne	67916C-LBC-24	24	12,9W	1430	350mA	3000		>90
	Ga	67917C-LBC-24							
	Br	67915C-LBN-24							
	Ne	67916C-LBN-24	24	12,9W	1510	350mA	4000		>90
	Ga	67917C-LBN-24							
	Br	67915C-LBC-40							
	Ne	67916C-LBC-40	40	12,9W	1360	350mA	3000		>90
	Ga	67917C-LBC-40							
	Br	67915C-LBN-40							
	Ne	67916C-LBN-40	40	12,9W	1430	350mA	4000		>90
	Ga	67917C-LBN-40							

ALIMENTATORI CONSIGLIATI - RECOMMENDED DRIVERS

644759-1	DN-OFF	15W	IP20	350mA
645984	DN-OFF	15W	IP40	350mA

					(W)	(lm)	(V)	(K)	(CRI)
	VERSIONE CON 3 LED - 3 LED VERSION								
	Br	67915-LBC-10	67915-LBC-30	67915-LBC-45	3x12W	240	350mA	3000	>90
	Ne	67916-LBC-10	67916-LBC-30	67916-LBC-45	3x2W	330	500mA		
	Ga	67917-LBC-10	67917-LBC-30	67917-LBC-45					
	Br	67915-LBI-10	67915-LBI-30	67915-LBI-45	3x12W	300	350mA	6000	>90
	Ne	67916-LBI-10	67916-LBI-30	67916-LBI-45	3x2W	420	500mA		
	Br	67915-LBL-10	67915-LBL-30	67915-LBL-45	3x12W	-	350mA	470nm	>90
	Ne	67916-LBL-10	67916-LBL-30	67916-LBL-45	3x2W		500mA		
	Ga	67917-LBL-10	67917-LBL-30	67917-LBL-45					

ALIMENTATORI CONSIGLIATI - RECOMMENDED DRIVERS

644758	DN-OFF	8W	IP20	350mA
644759-1	DN-OFF	15W	IP20	350mA
646427	DN-OFF	12W	IP20	350mA
645086	DF	20W	IP20	500mA
645833	dim T.f.	15W	IP20	500mA



STILO 28 INCASSO



50 mm 1+25 mm



- Corpo in alluminio estruso verniciato.
 - Verniciatura in polveri di poliestere.
 - Gruppo di alimentazione integrato.
 - Led durata utile: 50.000 (h) L80 B20.
- Body made of extruded aluminium.
 - Polyester powder coating
 - Built-in power supply unit.
 - Led life: 50.000 (h) L80 B20.

					W	lm	V	K	CRI
Br 67815-LBC-8					4W	480	220-240V (350mA)	3000	>90
Ne 67816-LBC-8									
Br 67815-LBN-8					4W	533	220-240V (350mA)	4000	>90
Ne 67816-LBN-8									
DALI DIM-DALI/PUSH									
Br 67815-LBC-8-DA					4W	480	220-240V (350mA)	3000	>90
Ne 67816-LBC-8-DA									
Br 67815-LBN-8-DA					4W	533	220-240V (350mA)	4000	>90
Ne 67816-LBN-8-DA									

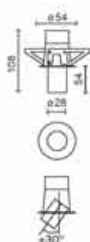

0.25

ALIMENTATORI CONSIGLIATI - DRIVERS RECOMMENDED

646098	ON-OFF	8W	IP20	350mA
646601	DALI	30W	IP20	250/700mA



ALIMENTATORI-KIT RGB (se non in dotazione) da ordinare dalla sezione arancio - DRIVERS-RGB KITS (when not supplied) to be ordered from the section orange color



STILO 60 INCASSO TONDO

- Incasso in pressofusione di alluminio.
- Spot estraibile e orientabile in pressofusione di alluminio.
- Verniciatura in polveri di poliestere.
- Lente in materiale ottico.
- Led durata utile: 50.000 (h) L80 B20.
- Consistenza cromatica: 3 SDCM.

- Recessed fixture made of die cast aluminium.
- Pull out and adjustable spot made of die cast aluminium.
- Polyester powder coating
- Lens of optical material.
- Led life: 50.000 (h) L80 B20.
- Chromatic consistency: 3 SDCM.



107 mm $\Delta = 1+30$ mm

					W	lm	V	K	CRI
Br	68044-LBC-19	68044-LBC-27	68044-LBC-38	68044-LBC-56	14,4W	1696	220-240V [400mA]	3000	>90
Ne	68045-LBC-19	68045-LBC-27	68045-LBC-38	68045-LBC-56					
Gr	68046-LBC-19	68046-LBC-27	68046-LBC-38	68046-LBC-56					
Br	68044-LBN-19	68044-LBN-27	68044-LBN-38	68044-LBN-56	14,4W	1840	220-240V [400mA]	4000	>90
Ne	68045-LBN-19	68045-LBN-27	68045-LBN-38	68045-LBN-56					
Gr	68046-LBN-19	68046-LBN-27	68046-LBN-38	68046-LBN-56					

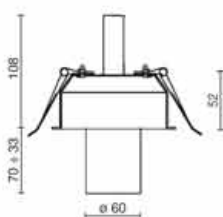

$\phi 120$

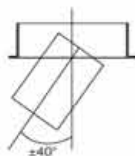

SGP
0,80

ALIMENTATORI CONSIGLIATI - DRIVERS RECOMMENDED

645984	ON-OFF	15W	IP20	350mA
645938	DIM PUSH/1+10V	15W	IP20	350mA
645939	DALI	15W	IP20	350mA

OP. A richiesta - On request: disponibile - available



A richiesta - On request: Cornice frontale - Front ring

Br 3126-1
Ne 3126-2
Oro 3126-3
Silver 3126-4



3126-5 Colore a richiesta - on request colour

ACC.

Br 3114
Ne 3115 Cilindro di schermatura - Shielding cylinder



Ne 3117 Griglia alveolare - Alveolar grid



Ne 3119 Cono frangiluce Spillring - Cone louver grid Spillring



3121 Lente Ellittica - Elliptical lens



3123 Lente diffondente - Wide flood



IP 20





STILO 60 INCASSO QUADRO



136 x 136 mm Δ = 1÷30 mm

- Incasso in pressofusione di alluminio.
 - Spot estraibile e orientabile in pressofusione di alluminio.
 - Verniciatura in polveri di poliestere.
 - Lente in materiale ottico.
 - Led durata utile: 50.000 (h) L80 B20.
 - Consistenza cromatica: 3 SDCM.
- Recessed fixture made of die cast aluminium.
 - Pull out and adjustable spot made of die cast aluminium.
 - Polyester powder coating.
 - Lens of optical material.
 - Led life: 50,000 (h) L80 B20.
 - Chromatic consistency: 3 SDCM.

					(W)	(lm)	(V)	(K)	(CRI)
Br	68055-LBC-19	68055-LBC-27	68055-LBC-38	68055-LBC-56	14,3W	1696	220-240V (400mA)	3000	>90
Ne	68056-LBC-19	68056-LBC-27	68056-LBC-38	68056-LBC-56					
Gr	68057-LBC-19	68057-LBC-27	68057-LBC-38	68057-LBC-56					
Br	68055-LBN-19	68055-LBN-27	68055-LBN-38	68055-LBN-56	14,3W	1840	220-240V (400mA)	4000	>90
Ne	68056-LBN-19	68056-LBN-27	68056-LBN-38	68056-LBN-56					
Gr	68057-LBN-19	68057-LBN-27	68057-LBN-38	68057-LBN-56					

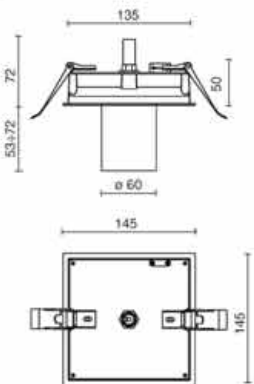

0,80 Kg

ALIMENTATORI CONSIGLIATI - DRIVERS RECOMMENDED

645984	ON-OFF	15W	IP20	350mA
645938	DIM PUSH/1÷10V	15W	IP20	350mA
645939	DALI	15W	IP20	350mA

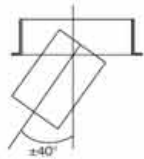

OP: A richiesta - On request: disponibile - available

A richiesta - On request:	Cornice frontale - Front ring	
Br	3126-1	
Ne	3126-2	
Oro	3126-3	
Silver	3126-4	
	3126-5 Colore a richiesta - on request colour	

ACC.		
Br	3114	Cilindro di schermatura - Shielding cylinder
Ne	3115	
Ne	3117	Griglia alveolare - Alveolar grid
Ne	3119	Cono frangiluce Spillring - Cone louver grid Spillring
	3121	Lente Ellittica - Elliptical lens
	3123	Lente diffondente - Wide flood

IP 20

ALIMENTATORI-KIT RGB (se non in dotazione) da ordinare dalla sezione arancio - DRIVERS-RGB KITS (when not supplied) to be ordered from the section orange color



RULED

Custom 1
bassa e alta potenza
low/High Power

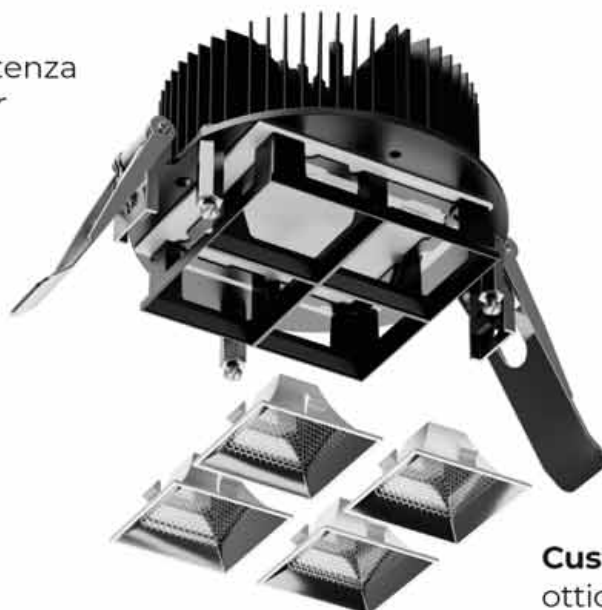

Custom 2
ottiche combinabili
combined optical

Custom 3
colore vetro
glass color



Custom 4
colore ghiera
ring color

OTTICHE
OPTICAL

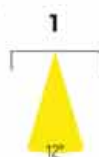

fascio 12°
beam 12°

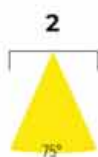

fascio 75°
beam 75°



fascio asimmetrico
asymmetrical beam
(AS)



fascio bi-asimmetrico
bi-asymmetrical beam
(BAS)

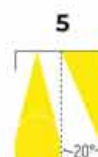

fascio ellittico + asimmetrico
elliptical beam + asymmetrical
(AE)

LEGENDA CODICE
LEGEND CODE





126 mm Δ 1±30 mm

- Cornice in pressofusione di alluminio verniciato.
- Verniciatura in polveri di poliestere.
- Ottiche in materiale termoplastico metallizzato in alto vuoto.
- Vetro di protezione trasparente serigrafato.
- Molle in acciaio.
- Alimentatore elettronico esterno in dotazione.
- Led durata utile: 50.000 (h) L80 B20.

- Frame made in die-cast aluminum painted.
- Polyester powder coating.
- High vacuum metallized thermoplastic reflectors.
- Screen-printed transparent protection glass.
- Steel springs.
- External electronic driver included.
- Led life: 50.000 (h) L80 B20.

	KIT	APPARECCHIO • ALIMENTATORE - FITTING • DRIVER	LED					SISTEMA-SYSTEM		
			W	lm	V	K	CRI	W	lm	lm/W
<p>0,50 Kg</p>	Br	KT5800LBC12	11,8W	1780	220-240V (500mA)	3000	>90	14W	1538	110
	Ne	KT5801LBC12								
	Br	KT5800LBN12	11,8W	1850	220-240V (500mA)	4000	>90	14W	1598	114
	Ne	KT5801LBN12								
	Br	KT5800LBC75	11,8W	1780	220-240V (500mA)	3000	>90	14W	1567	112
	Ne	KT5801LBC75								
	Br	KT5800LBN75	11,8W	1850	220-240V (500mA)	4000	>90	14W	1628	116
	Ne	KT5801LBN75								
	Br	KT5800LBCAS	11,8W	1780	220-240V (500mA)	3000	>90	14W	830	59
	Ne	KT5801LBCAS								
	Br	KT5800LBNAS	11,8W	1850	220-240V (500mA)	4000	>90	14W	863	62
	Ne	KT5801LBNAS								
Br	KT5800LBCBAS	11,8W	1780	220-240V (500mA)	3000	>90	14W	830	59	
Ne	KT5801LBCBAS									
Br	KT5800LBNBAS	11,8W	1850	220-240V (500mA)	4000	>90	14W	863	62	
Ne	KT5801LBNBAS									
Br	KT5800LBCAE	11,8W	1780	220-240V (500mA)	3000	>90	14W	1180	84	
Ne	KT5801LBCAE									
Br	KT5800LBNAE	11,8W	1850	220-240V (500mA)	4000	>90	14W	1225	88	
Ne	KT5801LBNAE									
<p>1,00 Kg</p>	Br	KT5805LBC12	38,5W	3840	220-240V (800mA)	3000	>90	42,5W	3318	78
	Ne	KT5806LBC12								
	Br	KT5805LBN12	38,5W	4000	220-240V (800mA)	4000	>90	42,5W	3456	81
	Ne	KT5806LBN12								
	Br	KT5805LBC75	38,5W	3840	220-240V (800mA)	3000	>90	42,5W	3379	80
	Ne	KT5806LBC75								
	Br	KT5805LBN75	38,5W	4000	220-240V (800mA)	4000	>90	42,5W	3520	83
	Ne	KT5806LBN75								
	Br	KT5805LBCAS	38,5W	3840	220-240V (800mA)	3000	>90	42,5W	1792	42
	Ne	KT5806LBCAS								
	Br	KT5805LBNAS	38,5W	4000	220-240V (800mA)	4000	>90	42,5W	1866	44
	Ne	KT5806LBNAS								
Br	KT5805LBCBAS	38,5W	3840	220-240V (800mA)	3000	>90	42,5W	1792	42	
Ne	KT5806LBCBAS									
Br	KT5805LBNBAS	38,5W	4000	220-240V (800mA)	4000	>90	42,5W	1866	44	
Ne	KT5806LBNBAS									
Br	KT5805LBCAE	38,5W	3840	220-240V (800mA)	3000	>90	42,5W	2544	60	
Ne	KT5806LBCAE									
Br	KT5805LBNAE	38,5W	4000	220-240V (800mA)	4000	>90	42,5W	2650	62	
Ne	KT5806LBNAE									

OP. A richiesta - On request: disponibile - available **FOOD** **DALI** **EM**

* Solo apparecchio - Only fitting



ALIMENTATORI-KIT RGB (se non in dotazione) da ordinare dalla sezione arancio - DRIVERS-RGB KITS (when not supplied) to be ordered from the section orange color



RULED T 15

- Cornice in policarbonato.
- Ottiche in materiale termoplastico metallizzato in alto vuoto.
- Vetro di protezione trasparente serigrafato.
- Molle in acciaio.
- Alimentatore elettronico esterno in dotazione.
- Led durata utile: 50.000 (h) L80 B20.

- Frame in polycarbonate.
- High vacuum metallized thermoplastic reflectors.
- Screen-printed transparent protection glass.
- Steel springs.
- External electronic driver included.
- Led life: 50.000 (h) L80 B20.



	KIT	APPARECCHIO + ALIMENTATORE - FITTING + DRIVER	LED			SISTEMA-SYSTEM				
			W	lm	V	K	CR	W	lm	IP
	Br	KT5820LBC12	16W	2305	220-240V (650mA)	3000	>90	18W	1992	111
	Ne	KT5821LBC12								
	Br	KT5820LBN12	16W	2400	220-240V (650mA)	4000	>90	18W	2074	115
	Ne	KT5821LBN12								
	Br	KT5820LBC75	16W	2305	220-240V (650mA)	3000	>90	18W	2028	113
	Ne	KT5821LBC75								
	Br	KT5820LBN75	16W	2400	220-240V (650mA)	4000	>90	18W	2112	117
	Ne	KT5821LBN75								
	Br	KT5820LBCAS	16W	2305	220-240V (650mA)	3000	>90	18W	1076	60
	Ne	KT5821LBCAS								
	Br	KT5820LBNAS	16W	2400	220-240V (650mA)	4000	>90	18W	1120	62
	Ne	KT5821LBNAS								
	Br	KT5820LBCBAS	16W	2305	220-240V (650mA)	3000	>90	18W	1076	60
	Ne	KT5821LBCBAS								
Br	KT5820LBNBAS	16W	2400	220-240V (650mA)	4000	>90	18W	1120	62	
Ne	KT5821LBNBAS									
Br	KT5820LBCAE	16W	2305	220-240V (650mA)	3000	>90	18W	1527	85	
Ne	KT5821LBCAE									
Br	KT5820LBNAE	16W	2400	220-240V (650mA)	4000	>90	18W	1590	88	
Ne	KT5821LBNAE									
	Br	KT5825LBC12	38,4W	3840	220-240V (800mA)	3000	>90	42,5W	3318	78
	Ne	KT5826LBC12								
	Br	KT5825LBN12	38,4W	4000	220-240V (800mA)	4000	>90	42,5W	3456	81
	Ne	KT5826LBN12								
	Br	KT5825LBC75	38,4W	3840	220-240V (800mA)	3000	>90	42,5W	3379	80
	Ne	KT5826LBC75								
	Br	KT5825LBN75	38,4W	4000	220-240V (800mA)	4000	>90	42,5W	3520	83
	Ne	KT5826LBN75								
	Br	KT5825LBCAS	38,4W	3840	220-240V (800mA)	3000	>90	42,5W	1792	42
	Ne	KT5826LBCAS								
	Br	KT5825LBNAS	38,4W	4000	220-240V (800mA)	4000	>90	42,5W	1866	44
	Ne	KT5826LBNAS								
	Br	KT5825LBCBAS	38,4W	3840	220-240V (800mA)	3000	>90	42,5W	1792	42
	Ne	KT5826LBCBAS								
Br	KT5825LBNBAS	38,4W	4000	220-240V (800mA)	4000	>90	42,5W	1866	44	
Ne	KT5826LBNBAS									
Br	KT5825LBCAE	38,4W	3840	220-240V (800mA)	3000	>90	42,5W	2544	60	
Ne	KT5826LBCAE									
Br	KT5825LBNAE	38,4W	4000	220-240V (800mA)	4000	>90	42,5W	2650	62	
Ne	KT5826LBNAE									

OP: A richiesta - On request - disponibile - available



* Solo apparecchio - Only fitting



ALIMENTATORI-KIT RGB (se non in dotazione) da ordinare dalla sezione arancio - DRIVERS-RGB KITS (when not supplied) to be ordered from the section orange color



- Cornice in policarbonato.
- Ottiche in materiale termoplastico metallizzato in alto vuoto.
- Parabola di protezione trasparente serigrafato.
- Molle in acciaio.
- Alimentatore elettronico esterno in dotazione.
- Led durata utile: 50.000 [h] L80 B20.

- Frame in polycarbonate.
- High vacuum metallized thermoplastic reflectors.
- Screen-printed transparent protection glass.
- Steel springs.
- External electronic driver included.
- Led life: 50.000 [h] L80 B20.



190 mm $\Delta = 1+30$ mm

	KIT	APPARECCHIO + ALIMENTATORE - FITTING + DRIVER	LED					SISTEMA-SYSTEM		
			W	lm	V	K	CRI	W	lm	W
Br Ne	KT5840LBC12 KT5841LBC12	AS	20W	2785	220-240V (800mA)	3000	>90	23W	2406	105
Br Ne	KT5840LBN12 KT5841LBN12	AS	20W	2900	220-240V (800mA)	4000	>90	23W	2551	109
Br Ne	KT5840LBC75 KT5841LBC75	AS	20W	2785	220-240V (800mA)	3000	>90	23W	2451	107
Br Ne	KT5840LBN75 KT5841LBN75	AS	20W	2900	220-240V (800mA)	4000	>90	23W	2552	111
Br Ne	KT5840LBCAS KT5841LBCAS	AS	20W	2785	220-240V (800mA)	3000	>90	23W	1299	56
Br Ne	KT5840LBNAS KT5841LBNAS	AS	20W	2900	220-240V (800mA)	4000	>90	23W	1353	59
Br Ne	KT5840LBCBAS KT5841LBCBAS	AS	20W	2785	220-240V (800mA)	3000	>90	23W	1299	56
Br Ne	KT5840LBNBAS KT5841LBNBAS	AS	20W	2900	220-240V (800mA)	4000	>90	23W	1353	59
Br Ne	KT5840LBCAE KT5841LBCAE	AS-ELL	20W	2785	220-240V (800mA)	3000	>90	23W	1845	80
Br Ne	KT5840LBNAE KT5841LBNAE	AS-ELL	20W	2900	220-240V (800mA)	4000	>90	23W	1922	84

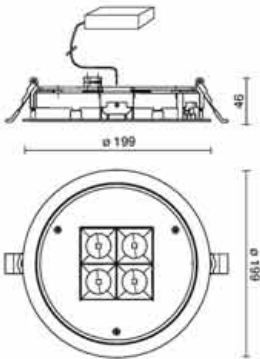

0,90 Kg

OP. A richiesta - On request-disponibile - available



* Solo apparecchio - Only fitting



ALIMENTATORI-KIT RGB (se non in dotazione) da ordinare dalla sezione arancio - DRIVERS-RGB KITS (when not supplied) to be ordered from the section orange color







- Cornice in policarbonato.
- Ottiche in materiale termoplastico metallizzato in alto vuoto.
- Vetro di protezione trasparente serigrafato.
- Molle in acciaio.
- Alimentatore elettronico esterno in dotazione.
- Led durata utile: 50.000 (h) L80 B20.



190 mm Δ 1+30 mm

- Frame in polycarbonate.
- High vacuum metallized thermoplastic reflectors.
- Screen-printed transparent protection glass.
- Steel springs.
- External electronic driver included.
- Led life: 50.000 (h) L80 B20.

	K I T	APPARECCHIO + ALIMENTATORE - FITTING + DRIVER	LED					SISTEMA-SYSTEM		
			W	lm	V	K	CRI	W	lm	W
	Br	KT584SLBC12	30W	3860	220-240V [1200mA]	3000	>90	34W	3335	98
	Ne	KT5846LBC12								
	Br	KT584SLBN12	30W	4000	220-240V [1200mA]	4000	>90	34W	3456	102
	Ne	KT5846LBN12								
	Br	KT584SLBC75	30W	3860	220-240V [1200mA]	3000	>90	34W	3397	100
	Ne	KT5846LBC75								
	Br	KT584SLBN75	30W	4000	220-240V [1200mA]	4000	>90	34W	3520	104
	Ne	KT5846LBN75								
	Br	KT584SLBCAS	30W	3860	220-240V [1200mA]	3000	>90	34W	1801	53
	Ne	KT5846LBCAS								
	Br	KT584SLBNAS	30W	4000	220-240V [1200mA]	4000	>90	34W	1866	55
	Ne	KT5846LBNAS								
	Br	KT584SLBCBAS	30W	3860	220-240V [1200mA]	3000	>90	34W	1801	53
	Ne	KT5846LBCBAS								
Br	KT584SLBNBAS	30W	4000	220-240V [1200mA]	4000	>90	34W	1866	55	
Ne	KT5846LBNBAS									
Br	KT584SLBCAE	30W	3860	220-240V [1200mA]	3000	>90	34W	2558	75	
Ne	KT5846LBCAE									
Br	KT584SLBNAE	30W	4000	220-240V [1200mA]	4000	>90	34W	2650	78	
Ne	KT5846LBNAE									
	Br	KT5850LBC12	43W	5790	220-240V [1750mA]	3000	>90	47W	5003	106
	Ne	KT5851LBC12								
	Br	KT5850LBN12	43W	6000	220-240V [1750mA]	4000	>90	47W	5184	110
	Ne	KT5851LBN12								
	Br	KT5850LBC75	43W	5790	220-240V [1750mA]	3000	>90	47W	5095	108
	Ne	KT5851LBC75								
	Br	KT5850LBN75	43W	6000	220-240V [1750mA]	4000	>90	47W	5280	112
	Ne	KT5851LBN75								
	Br	KT5850LBCAS	43W	5790	220-240V [1750mA]	3000	>90	47W	2702	57
	Ne	KT5851LBCAS								
	Br	KT5850LBNAS	43W	6000	220-240V [1750mA]	4000	>90	47W	2800	60
	Ne	KT5851LBNAS								
	Br	KT5850LBCBAS	43W	5790	220-240V [1750mA]	3000	>90	47W	2702	57
	Ne	KT5851LBCBAS								
Br	KT5850LBNBAS	43W	6000	220-240V [1750mA]	4000	>90	47W	2800	60	
Ne	KT5851LBNBAS									
Br	KT5850LBCAE	43W	5790	220-240V [1750mA]	3000	>90	47W	3836	82	
Ne	KT5851LBCAE									
Br	KT5850LBNAE	43W	6000	220-240V [1750mA]	4000	>90	47W	3976	85	
Ne	KT5851LBNAE									

QP. A richiesta - On request: disponibile - available **FOOD** **DALI** **EM**

* Solo apparecchio - Only fitting



ALIMENTATORI-KIT RGB (se non in dotazione) da ordinare dalla sezione arancio - DRIVERS-RGB KITS (when not supplied) to be ordered from the section orange color







LUCE DIFFUSA - FLOODLIGHTING
SEZIONE TONDA - ROUND SELECTION
TWIST



92 mm 5+30 mm

- Corpo in lamiera verniciata.
 - Verniciatura in polveri di poliestere.
 - Dissipatore in estruso di alluminio.
 - Schermo in policarbonato opale.
 - Led durata utile: 50.000 (h) L90 B50.
 - Consistenza cromatica: 3 SDCM.
- Body made of coated sheet steel.
 - Polyester powder coating.
 - Extruded aluminium heatsink.
 - Opal polycarbonate screen.
 - Led life: 50.000 (h) L90 B50.
 - Chromatic consistency: 3 SDCM.

		Bi 2865-LBC	24W	3365	700mA	3000	>90				
		Ne 2866-LBC									
		Bi 2865-LBN	24W	3570	700mA	4000	>90				
		Ne 2866-LBN									
ALIMENTATORI - DRIVERS											
644936	ON-OFF	IP40	25W	700mA							
644757	DIMM 1-10V	IP20	25W	700mA							
644757-DA	DALI	IP20	32W	700mA							

			LED					SYSTEM-SYSTEM			
			W	lm	V	K	CRI	W	lm	lm/W	
		K I T									
		APPARECCHIO + ALIMENTATORE - FITTING + DRIVER									
		Bi KT2865-LBC	24W	3365	700mA	3000	>90	27W	2592	91	
		Ne KT2866-LBC									
Bi KT2865-LBN	24W	3570	700mA	4000	>90	27W	2750	90			
Ne KT2866-LBN											

OP. A richiesta - On request: Led con temperatura di colore 2700K - Temperature Led colour 2700K
disponibile - available



ACC. 152 Piastra di rinforzo per pannelli in mineralite
Reinforcing plate for mineralite panels



*Solo apparecchio - Only fitting



inside

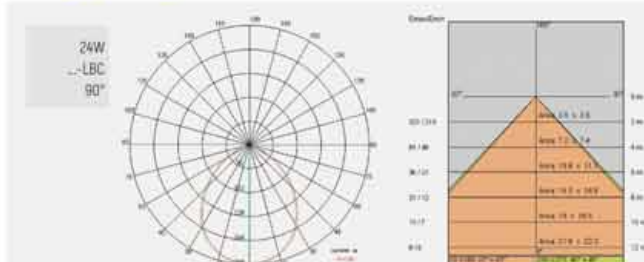

ALIMENTATORI-KIT RGB (se non in dotazione) da ordinare dalla sezione arancio - DRIVERS-RGB KITS (when not supplied) to be ordered from the section orange color

STEP 15

- Cornice in policarbonato.
 - Riflettore in alluminio anodizzato.
 - Diffusore in policarbonato sabbato.
 - Dissipatore passivo.
 - Driver integrato nel modulo Led.
- Polycarbonate frame.
 - Anodized aluminium reflector.
 - Frosted polycarbonate diffuser.
 - Passive heatsink.
 - Led module with built-in driver.



156 mm \pm 5-30 mm

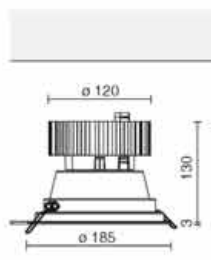

0,50

		LED					SYSTEM-SYSTEM		
		W	lm	V	K	CRI	W	lm	W
Bi	57420-LBC 57420-LBN	18W	2000	220-240V	3000 4000	>90	18W	1734	96
	57421-LBC 57421-LBN	27W	3000	220-240V	3000 4000	>90	27W	2601	96
DALI DIM-DALI/PUSH									
Bi	57420-LBC-DA 57420-LBN-DA	18W	2000	220-240V [500mA]	3000 4000	>90	20W	1734	87
	57421-LBC-DA 57421-LBN-DA	28W	3000	220-240V [800mA]	3000 4000	>90	30W	2601	87

IP 20 RGO

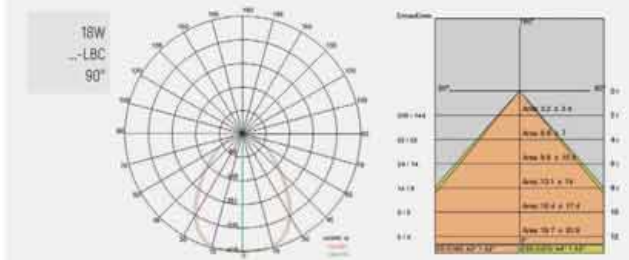

ALIMENTATORI-KIT RGB (se non in dotazione) da ordinare dalla sezione arancio - DRIVERS-RGB KITS (when not supplied) to be ordered from the section orange color



- Cornice in policarbonato.
- Riflettore in alluminio anodizzato.
- Diffusore in policarbonato sabbato.
- Dissipatore passivo.
- Led durata utile: 50.000 (h) L70 B50.

- Polycarbonate frame.
- Anodized aluminium reflector.
- Frosted polycarbonate diffuser.
- Passive heatsink.
- Led life: 50.000 (h) L70 B50.



205 mm 5+30 mm

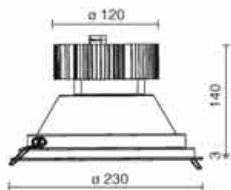

	Bi	57437-LBC 57437-LBN	LED					SISTEMA-SYSTEM		
			W	lm	V	K	CRI	W	lm	lm/W
	Bi	57437-LBC-DA 57437-LBN-DA	18W	2000	220-240V (500mA)	3000 4000	>90	20W	1734	91
	Bi	57438-LBC-DA 57438-LBN-DA	28W	3000	220-240V (800mA)	3000 4000	>90	30W	2601	91

UGR <19

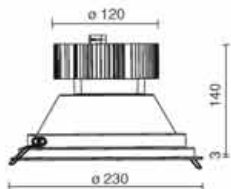

	Bi	57437-LBC-UGR 57437-LBN-UGR	LED					SISTEMA-SYSTEM		
			W	lm	V	K	CRI	W	lm	lm/W
	Bi	57437-LBC-UGR-DA 57437-LBN-UGR-DA	18W	2000	220-240V (800mA)	3000 4000	>90	20W	1820	91
	Bi	57438-LBC-UGR-DA 57438-LBN-UGR-DA	28W	3000	220-240V (800mA)	3000 4000	>90	30W	2730	91

- ACC. 125 Anello di compensazione - Compensation ring
d=205 mm/D=255 mm
- 126 Anello di compensazione - Compensation ring
d=205 mm/D=270 mm

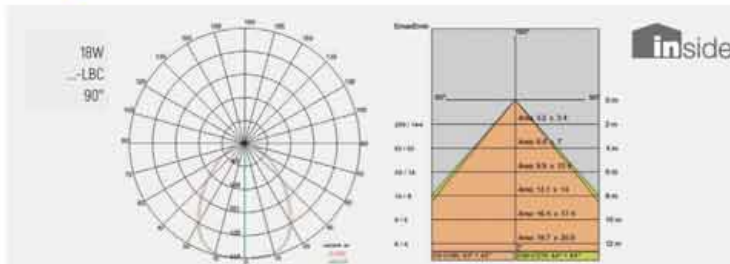
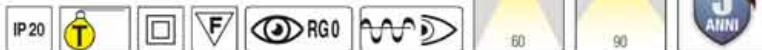
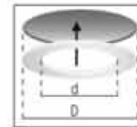





- Vano ottico in pressofusione di alluminio verniciato.
 - Verniciatura in polveri di poliestere.
 - Riflettore in alluminio purissimo.
 - Dissipatore passivo.
 - Schermo di protezione Led in vetro extrachiario.
 - Led durata utile: 50.000 (h) L90 B50.
- Optic tray made of die-cast aluminium painted.
 - Polyester powder coating
 - Reflector of pure aluminium.
 - Passive heatsink.
 - Clear glass screen protection Led.
 - Led life: 50.000 (h) L90 B50.



125 mm 1+30 mm

	12	25	40	LED					SISTEMA-SYSTEM		
				W	lm	V	K	CRI	W	lm	IP
Bi 57558-LBC-12	57558-LBC-25	57558-LBC-40		32W	4400	220-240V	3000	>90	36W	3960	110
Gi 57559-LBC-12	57559-LBC-25	57559-LBC-40				(900mA)					
Bi 57558-LBN-12	57558-LBN-25	57558-LBN-40		52W	4600	220-240V	4000	>90	36W	4170	116
Gi 57559-LBN-12	57559-LBN-25	57559-LBN-40				(900mA)					
Bi 57558-BC12-DA	57558-BC25-DA	57558-BC40-DA		32W	4400	220-240V	3000	>90	36W	3960	110
Gi 57559-BC12-DA	57559-BC25-DA	57559-BC40-DA				(900mA)					
Bi 57558-BN12-DA	57558-BN25-DA	57558-BN40-DA		52W	4600	220-240V	4000	>90	36W	4170	116
Gi 57559-BN12-DA	57559-BN25-DA	57559-BN40-DA				(900mA)					

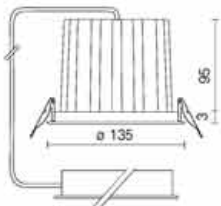

1,00 Kg



ALIMENTATORI-KIT RGB (se non in dotazione) da ordinare dalla sezione arancio - DRIVERS-RGB KITS (when not supplied) to be ordered from the section orange color



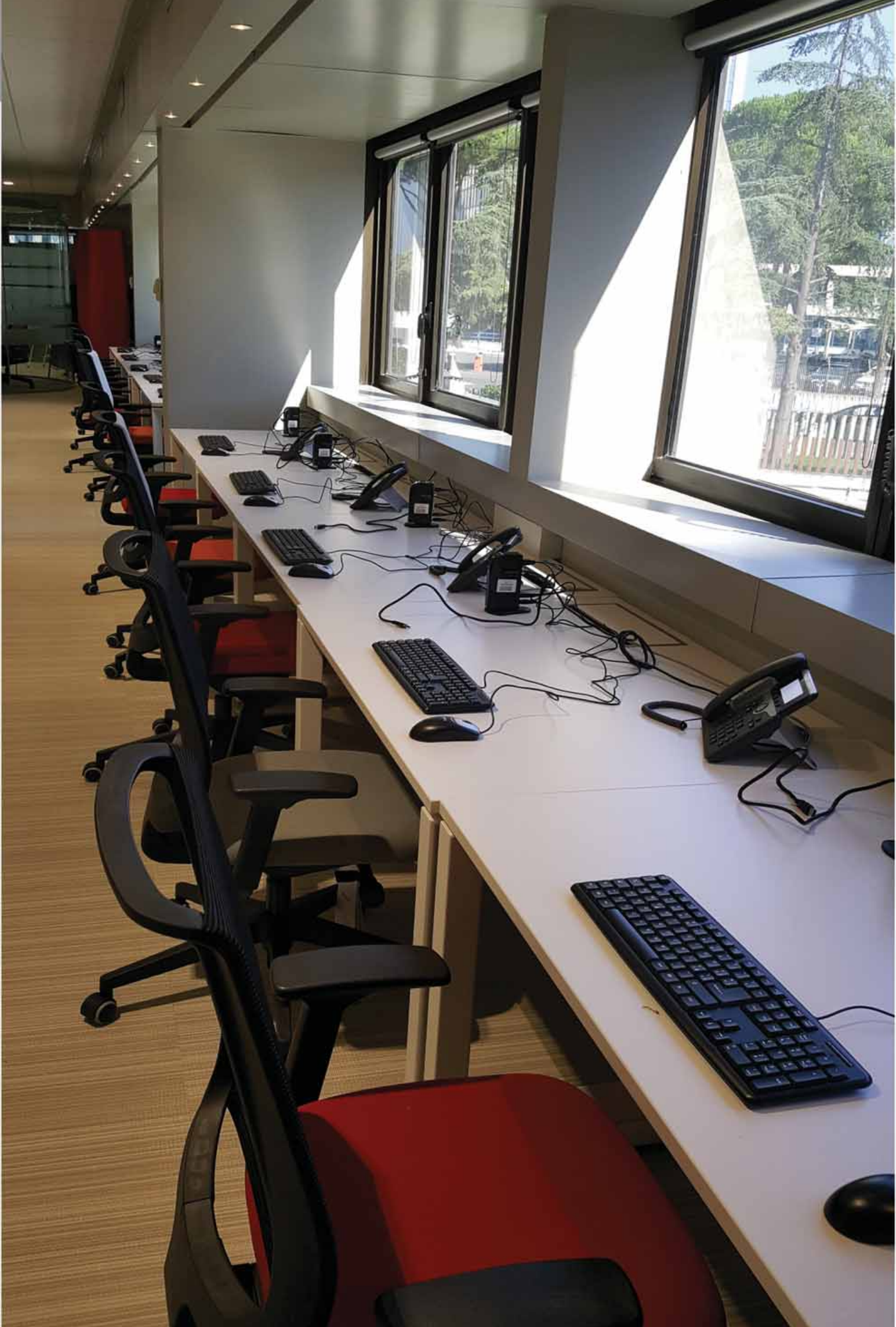



- Vano ottico in pressofusione di alluminio verniciato.
 - Verniciatura in polveri di poliestere.
 - Riflettore in alluminio purissimo.
 - Dissipatore passivo.
 - Schermo di protezione Led in policarbonato.
 - Led durata utile: 50.000 (h) L90 B50.
 - Consistenza cromatica: 3 SDCM.
- Optic tray made of die-cast aluminium painted.
 - Polyester powder coating
 - Pure aluminium reflector.
 - Passive heatsink.
 - Polycarbonate screen protection Led.
 - Led life: 50.000 (h) L90 B50.
 - Chromatic consistency: 3 SDCM.



156 mm 0+30 mm

	40	90	LED					SYSTEM-SYSTEM				
			W	lm	V	K	CRI	W	lm	W		
Br	57564-LBC	57560-LBC	24W	3365	220-240V (700mA)	3000	>90	27W	3012	111	[60°]	
Ga	57565-LBC	57561-LBC										24W
Br	57564-LBI	57560-LBI	24W	3570	220-240V (700mA)	4000	>90	27W	3198	118	[90°]	
Ga	57565-LBI	57561-LBI										37W
Br	57566-LBC	57562-LBC	37W	4740	220-240V (1050mA)	4000	>90	47W	4246	103	[90°]	
Ga	57567-LBC	57563-LBC										37W
Br	57566-LBI	57562-LBI	37W	4970	220-240V (1050mA)	4000	>90	47W	4452	108	[90°]	
Ga	57567-LBI	57563-LBI										
DALI												
Br	57564-LBC-DA	57560-LBC-DA	24W	3365	220-240V (700mA)	3000	>90	27W	3012	111	[60°]	
Ga	57565-LBC-DA	57561-LBC-DA										24W
Br	57564-LBI-DA	57560-LBI-DA	24W	3570	220-240V (700mA)	4000	>90	27W	3198	118	[90°]	
Ga	57565-LBI-DA	57561-LBI-DA										37W
Br	57566-LBC-DA	57562-LBC-DA	37W	4740	220-240V (1050mA)	4000	>90	47W	4246	103	[90°]	
Ga	57567-LBC-DA	57563-LBC-DA										37W
Br	57566-LBI-DA	57562-LBI-DA	37W	4970	220-240V (1050mA)	4000	>90	47W	4452	108	[90°]	
Ga	57567-LBI-DA	57563-LBI-DA										

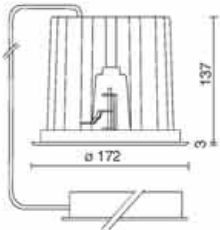

1.50 Kg

DR. A richiesta - On request: Led con temperatura di COLORE 2700K - Temperature Led COLOUR 2700K

ACC. A richiesta: versione in emergenza aggiungendo il Kit - On request: emergency version adding Kit
INV 1052 Kit 1h
INV 1052-3 Kit 3h

122 Anello di compensazione - Compensation ring

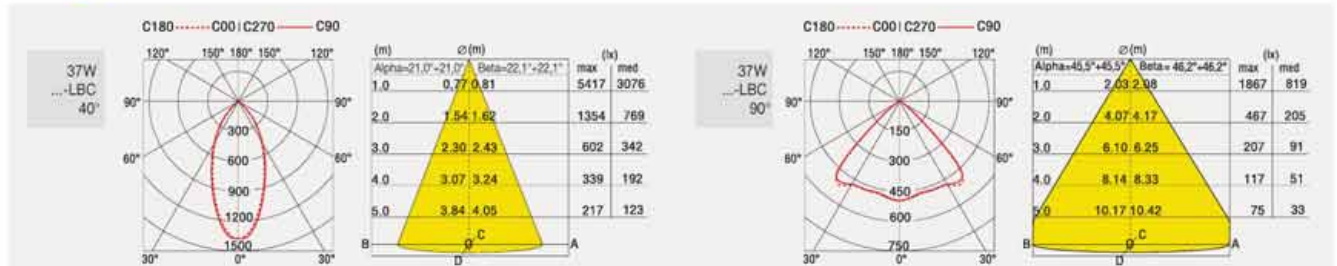
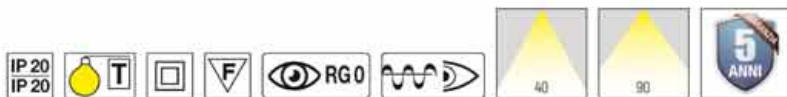
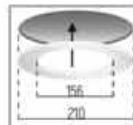

ALIMENTATORI-KIT RGB (se non in dotazione) da ordinare dalla sezione arancio - DRIVERS-RGB KITS (when not supplied) to be ordered from the section orange color



inside

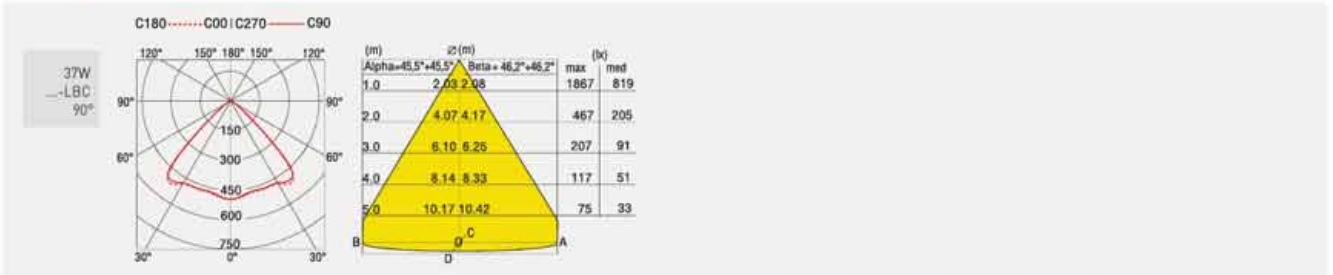

ALIMENTATORI-KIT RGB (se non in dotazione) da ordinare dalla sezione arancio - DRIVERS-RGB KITS (when not supplied) to be ordered from the section orange color



- Vano ottico in pressofusione di alluminio verniciato.
 - Verniciatura in polveri di poliestere.
 - Riflettore in alluminio purissimo.
 - Dissipatore passivo.
 - Schermo di protezione Led in policarbonato.
 - Led durata utile: 50.000 (h) L90 B50.
 - Consistenza cromatica: 3 SDCM.
- Optic tray made of die-cast aluminium painted.
 - Polyester powder coating
 - Pure aluminium reflector.
 - Passive heatsink.
 - Polycarbonate screen protection Led.
 - Led life: 50.000 (h) L90 B50.
 - Chromatic consistency: 3 SDCM.



205 mm Δ 0+30 mm

	LED	SISTEMA-SYSTEM		
		W	lm	W
Br 57570-LBC Ga 57571-LBC	24W 3365	220-240V [700mA]	3000 >90	27W 3014 111
Br 57570-LBI Ga 57571-LBI	24W 3570	220-240V [700mA]	4000 >90	27W 3198 118
Br 57572-LBC Ga 57573-LBC	37W 4740	220-240V [1050mA]	3000 >90	41W 4246 103
Br 57572-LBI Ga 57573-LBI	37W 4970	220-240V [1050mA]	4000 >90	41W 4452 108
versione-version PLUS				
Br 57575-LBC Ga 57576-LBC	43W 5280	220-240V [1200mA]	3000 >90	47W 4729 101
Br 57575-LBI Ga 57576-LBI	43W 5520	220-240V [1200mA]	4000 >90	47W 4944 105
DALI				
Br 57570-LBC-DA Ga 57571-LBC-DA	24W 3365	220-240V [700mA]	3000 >90	27W 3014 111
Br 57570-LBI-DA Ga 57571-LBI-DA	24W 3570	220-240V [700mA]	4000 >90	27W 3198 118
Br 57572-LBC-DA Ga 57573-LBC-DA	37W 4740	220-240V [1050mA]	3000 >90	41W 4246 103
Br 57572-LBI-DA Ga 57573-LBI-DA	37W 4970	220-240V [1050mA]	4000 >90	41W 4452 108
versione-version PLUS				
Br 57575-LBC-DA Ga 57576-LBC-DA	43W 5280	220-240V [1200mA]	3000 >90	47W 4729 101
Br 57575-LBI-DA Ga 57576-LBI-DA	43W 5520	220-240V [1200mA]	4000 >90	47W 4944 105

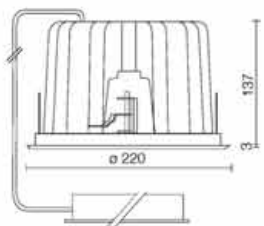

1kg
2,00

OP. A richiesta - On request: Led con temperatura di COLORE 2700K - Temperature Led COLOUR 2700K

ACC. A richiesta; versione in emergenza aggiungendo il Kit - On request: emergency version adding Kit
INV 1052 Kit 1h
INV 1052-3 Kit 3h

125 Anello di compensazione - Compensation ring

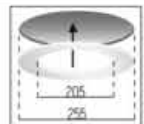



RASAMENTO A FILD CARTONGESSO - PLASTERBOARD FLAT FINISHING

NET XS

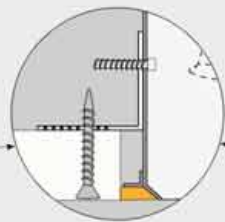
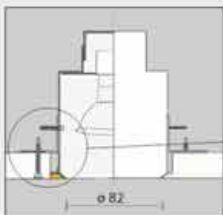
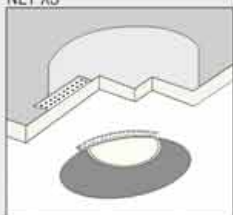

NET XL

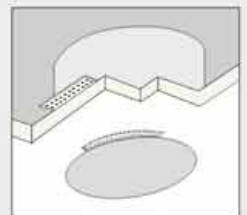
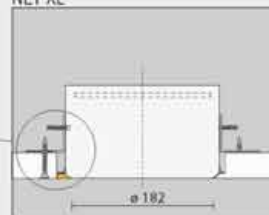

ALIMENTATORI-KIT RGB (se non in dotazione) da ordinare dalla sezione arancio - DRIVERS-RGB KITS (when not supplied) to be ordered from the section orange color



NET SC

SENZA CORNICE - TRIMLESS

- Corpo in metallo verniciato.

NET SC XS

- Gruppo ottico orientabile +/- 20°.

NET SC XL

- Gruppo di alimentazione integrato.

- Diffusore in policarbonato opalino in dotazione.

- Housing of painted metal.

NET SC XS

- +/- 20° adjustable optic.

NET SC XL

- Built-in power supply unit.

- Opal polycarbonate diffuser supplied.



NET SC XS



NET SC XL

NET SC XS				W	lm	V	K	CRI
		Br	5695-MLBC-25 5695-MLBN-25	12,9W	1430 1510	350mA	3000 4000	>90
		Br	5695-MLBC-40 5695-MLBN-40	12,9W	1360 1430	350mA	3000 4000	>90
ALIMENTATORE CONSIGLIATO - DRIVER RECOMMENDED 645833 DIM T.F. 15W IP20 230/240V/500mA								

o 110 5±30 mm

NET SC XL				LED					SISTEMA-SYSTEM		
				W	lm	V	K	CRI	W	lm	h
		Br	5798-LBC 5798-LBN	13W	1700 1740	220-240V [700mA]	3000 4000	>90	15W	1360 1392	91 93
		ACC. A richiesta: versione in emergenza aggiungendo il Kit - On request: emergency version adding Kit INV 1052 Kit 1h INV 1052-3 Kit 3h									

o 200 5±30 mm

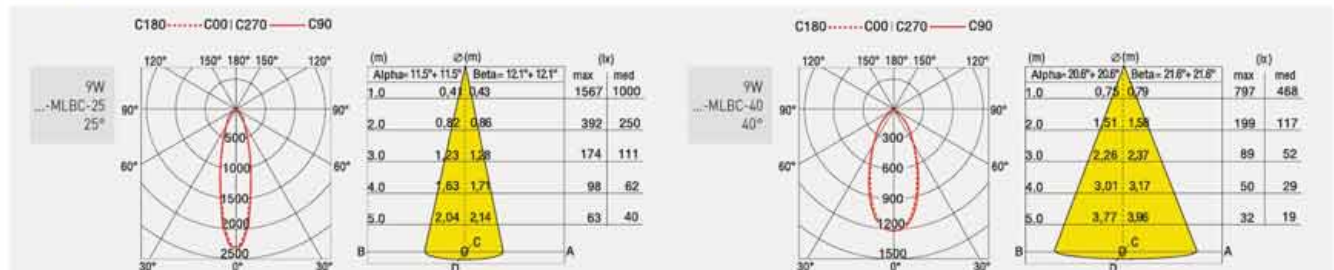

ALIMENTATORI-KIT RGB (se non in dotazione) da ordinare dalla sezione arancio - DRIVERS-RGB KITS (when not supplied) to be ordered from the section orange color

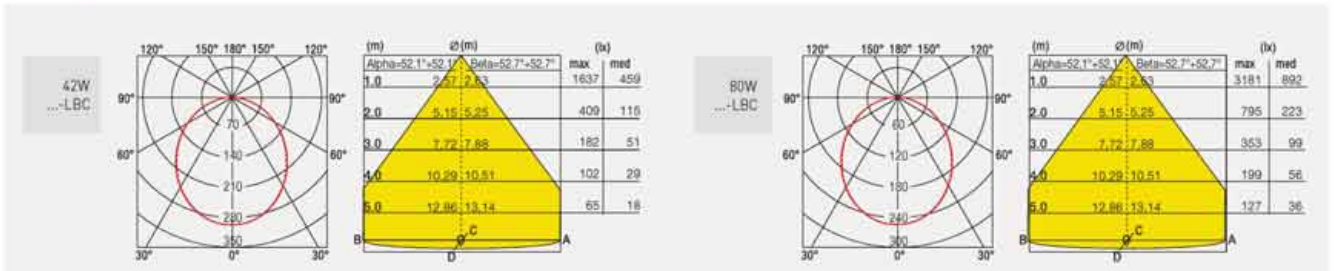

ALIMENTATORI-KIT RGB (se non in dotazione) da ordinare dalla sezione arancio - DRIVERS-RGB KITS (when not supplied) to be ordered from the section orange color



- Anello da incassare in alluminio verniciato con polveri epossidiche.
- Disco fissaggio e dissipazione Led in alluminio.
- Diffusore in policarbonato opale anti UV microprismato lato in vista.
- Verniciatura per interni in polveri epossidiche.
- Morsetto ad innesto rapido per collegamento cavo di rete.
- Pressacavo in gomma siliconica.

- Aluminium recess ring painted with epoxy powder.
- Aluminium fixing disk and Led dissipation.
- Microprismatic opal anti-UV polycarbonate diffuser.
- Indoor epoxy powder painting.
- Quick connect terminal for connecting the network cable.
- Cable gland in silicon rubber.

	LED	W	lm	V	K	CRI	SYSTEM-SYSTEM			
							W	lm	lm/W	
	BIG INCASSO 570 ON-OFF									
	Br 5503-LBC	42W	5500	220-240V	3000	>90	46W	4411	96	
	5503-LBN	5740	[700mA]	4000			4651	101		
	DIM 1+10V									
	Br 5503-LBC-DIM	42W	5500	220-240V	3000	>90	46W	4411	96	
	5503-LBN-DIM	5740	[700mA]	4000			4651	101		
	SA EMERGENZA - EMERGENCY									
	Br 5503-LBC-EM1	42W	5500	220-240V	3000	>90	46W	4411	96	
	5503-LBN-EM1	5740	[700mA]	4000			4651	101		
	Br 5503-LBC-EM3	42W	5500	220-240V	3000	>90	46W	4411	96	
	5503-LBN-EM3	5740	[700mA]	4000			4651	101		
	DALI									
Br 5503-LBC-DA	42W	5500	220-240V	3000	>90	46W	4411	96		
5503-LBN-DA	5740	[700mA]	4000			4651	101			

SEMPRE ACCESSO: n. 4 schede Led funzionanti per tutta la superficie dello schermo del prodotto.
EMERGENZA: n. 2 schede Led alternate funzionanti e n° 2 schede in OFF.
ALWAYS ON: n. 4 Led cards switch on for the whole screen's surface.
EMERGENCY MODE: n. 2 Led alternated cards switch on and n. 2 Led cards Switch off.

	LED	W	lm	V	K	CRI	SYSTEM-SYSTEM		
							W	lm	lm/W
	BIG INCASSO 770 ON-OFF								
	Br 5504-LBC	80W	11250	220-240V	3000	>90	84W	8572	102
	5504-LBN	11490	[700mA]	4000			8755	104	
	DIM 1+10V								
	Br 5504-LBC-DIM	80W	11250	220-240V	3000	>90	84W	8572	102
	5504-LBN-DIM	11490	[700mA]	4000			8755	104	
	SA EMERGENZA - EMERGENCY								
	Br 5504-LBC-EM1	80W	11250	220-240V	3000	>90	84W	8572	102
	5504-LBN-EM1	11490	[700mA]	4000			8755	104	
	Br 5504-LBC-EM3	80W	11250	220-240V	3000	>90	84W	8572	102
	5504-LBN-EM3	11490	[700mA]	4000			8755	104	
	DALI								
Br 5504-LBC-DA	80W	11250	220-240V	3000	>90	84W	8572	102	
5504-LBN-DA	11490	[700mA]	4000			8755	104		

SEMPRE ACCESSO: n. 8 schede Led funzionanti per tutta la superficie dello schermo del prodotto.
EMERGENZA: n. 4 schede Led alternate funzionanti e n° 4 schede in OFF.
ALWAYS ON: n. 8 Led cards switch on for the whole screen's surface.
EMERGENCY MODE: n. 4 Led alternated cards switch on and n. 4 Led cards Switch off.





- Anello da incassare in alluminio verniciato con polveri epossidiche.
- Disco fissaggio e dissipazione Led in alluminio.
- Diffusore in policarbonato opale anti UV microprismato lato in vista.
- Verniciatura per interni in polveri epossidiche.
- Morsetto ad innesto rapido per collegamento cavo di rete.
- Pressacavo in gomma silconica.

- Aluminium recess ring painted with epoxy powder.
- Aluminium fixing disk and Led dissipation.
- Microprismatic opal anti-UV polycarbonate diffuser.
- Indoor epoxy powder painting.
- Quick connect terminal for connecting the network cable.
- Cable gland in silicon rubber.



	LED	SISTEMA-SYSTEM				
		W	lm	lm/W		
	BIG INCASSO 290 ON-OFF Br 5508-LBC 5508-LBN	14W	1800	90		
		16W	1443	98		
		14W	1800	90		
		16W	1443	98		
		14W	1800	90		
		16W	1443	98		
	SA EMERGENZA - EMERGENCY Br 5508-LBC-EM1 5508-LBN-EM1 1h Br 5508-LBC-EM3 5508-LBN-EM3 3h	14W	1800	90		
		16W	1443	98		
		14W	1800	90		
		16W	1443	98		
				14W	1800	90
		16W	1443	98		
	BIG INCASSO 380 ON-OFF Br 5516-LBC 5516-LBN	18W	2600	99		
		21W	2089	109		
		18W	2600	99		
		21W	2089	109		
		18W	2600	99		
		21W	2089	109		
	SA EMERGENZA - EMERGENCY Br 5516-LBC-EM1 5516-LBN-EM1 1h Br 5516-LBC-EM3 5516-LBN-EM3 3h	18W	2600	99		
		21W	2089	109		
		18W	2600	99		
		21W	2089	109		
				18W	2600	99
		21W	2089	109		

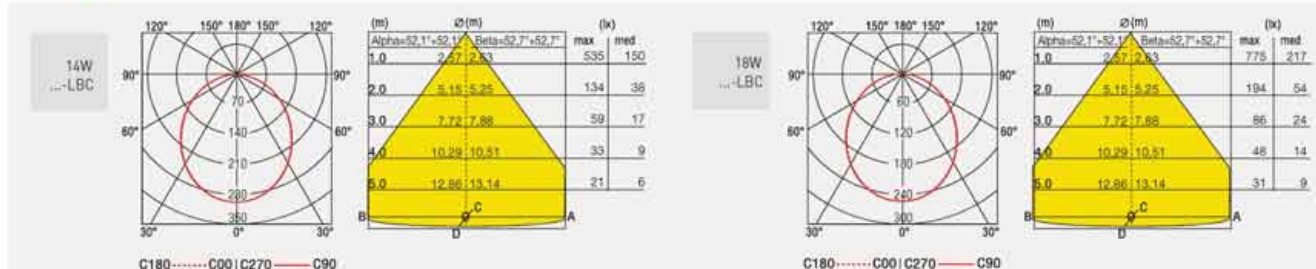

ALIMENTATORI-KIT RGB (se non in dotazione) da ordinare dalla sezione arancio - DRIVERS-RGB KITS (when not supplied) to be ordered from the section orange color

RULED Q 10

- Cornice in pressofusione di alluminio verniciato.
- Verniciatura in polveri di poliestere.
- Parabola in materiale termoplastico metallizzato in alto vuoto.
- Vetro di protezione trasparente.
- Molle in acciaio.
- Alimentatore elettronico esterno in dotazione.
- Led durata utile: 50.000 [h] L80 B20.

- Frame made in die-cast aluminum painted.
- Polyester powder coating
- High vacuum metallized thermoplastic reflectors.
- Transparent protection glass.
- Steel springs.
- External electronic driver included.
- Led life: 50.000 [h] L80 B20.



93 x 93 mm 1+30 mm

	KIT	APPARECCHIO + ALIMENTATORE - FITTING + DRIVER	LED					SISTEMA-SYSTEM		
			W	lm	V	K	CRI	W	lm	W
	Br	KT5870LBC12	11,8W	1780	220-240V (500mA)	3000	>90	13,8W	1538	111
	Ne	KT5871LBC12								
	Br	KT5870LBN12	11,8W	1850	220-240V (500mA)	4000	>90	13,8W	1598	116
	Ne	KT5871LBN12								
	Br	KT5870LBC75	11,8W	1780	220-240V (500mA)	3000	>90	13,8W	1566	114
	Ne	KT5871LBC75								
	Br	KT5870LNC75	11,8W	1850	220-240V (500mA)	4000	>90	13,8W	1628	118
	Ne	KT5871LBN75								
	Br	KT5870LBCAE	11,8W	1780	220-240V (500mA)	3000	>90	13,8W	1179	114
	Ne	KT5871LBCAE								
	Br	KT5870LBNAE	11,8W	1850	220-240V (500mA)	4000	>90	13,8W	1226	118
	Ne	KT5871LBNAE								

OP. A richiesta - On request/disponibile - available



* Solo apparecchio - Only fitting



inside

ALIMENTATORI-KIT RGB (se non in dotazione) da ordinare dalla sezione arancio - DRIVERS-RGB KITS (when not supplied) to be ordered from the section orange color



- Cornice in pressofusione di alluminio verniciato.
- Verniciatura in polveri di poliestere.
- Parabola in materiale termoplastico metallizzato in alto vuoto.
- Vetro di protezione trasparente serigrafato.
- Molle in acciaio.
- Alimentatore elettronico esterno in dotazione.
- Led durata utile: 50.000 [h] L80 B20.

- Frame made in die-cast aluminum painted.
- Polyester powder coating
- High vacuum metallized thermoplastic reflectors.
- Screen-printed transparent protection glass.
- Steel springs.
- External electronic driver included.
- Led life: 50.000 [h] L80 B20.



136 x 136 mm 1+30 mm

	KIT	APPARECCHIO + ALIMENTATORE - FITTING + DRIVER	LED					SISTEMA-SYSTEM		
			W	lm	V	K	CRI	W	lm	W
Br	KT5880LBC12	⚠	18W	2305	220-240V [650mA]	3000	>90	18W	1992	111
Ne	KT5881LBC12									
Br	KT5880LBN12	⚠	18W	2400	220-240V [650mA]	4000	>90	18W	2074	118
Ne	KT5881LBN12									
Br	KT5880LBC75	⚠	18W	2305	220-240V [650mA]	3000	>90	18W	2028	114
Ne	KT5881LBC75									
Br	KT5880LBN75	⚠	18W	2400	220-240V [650mA]	4000	>90	18W	2112	118
Ne	KT5881LBN75									
Br	KT5880LBCAS	⚠	18W	2305	220-240V [650mA]	3000	>90	18W	1076	114
Ne	KT5881LBCAS									
Br	KT5880LBNAS	⚠	18W	2400	220-240V [650mA]	4000	>90	18W	1120	118
Ne	KT5881LBNAS									
Br	KT5880LBCAE	⚠-ELL	18W	2305	220-240V [650mA]	3000	>90	18W	1527	114
Ne	KT5881LBCAE									
Br	KT5880LBNAE	⚠-ELL	18W	2400	220-240V [650mA]	4000	>90	18W	1590	118
Ne	KT5881LBNAE									

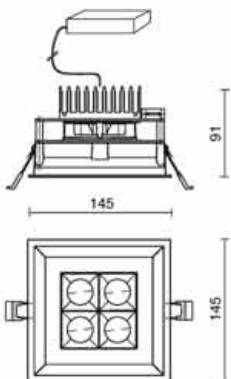

5Kgl
1,20

OP. A richiesta - On request, disponibile - available   

* Solo apparecchio - Only fitting



ALIMENTATORI-KIT RGB (se non in dotazione) da ordinare dalla sezione arancio - DRIVERS-RGB KITS (when not supplied) to be ordered from the section orange color



SINDI 60

- Corpo in pressofusione di alluminio verniciato.
- Verniciatura in polveri di poliestere.
- Schermo di protezione in policarbonato.
- Led durata utile: 50.000 (h) L90 B20.

- Body made of painted die-cast aluminum.
- Polyester powder coating.
- Coating protection screen polycarbonate.
- Led life: 50.000 (h) L90 B20.



54x54 mm 0-20 mm

		Ⓜ	Ⓛm	Ⓥ	Ⓚ	ⓈR
	Br 2868-LBC					
	Ne 2869-LBC	7W	830	200mA	3000	>90
	Ga 2870-LBC					
	Br 2868-LBN					
	Ne 2869-LBN	7W	880	200mA	4000	>90
	Ga 2870-LBN					
ALIMENTATORI CONSIGLIATI - RECOMMENDED DRIVERS						
646312	ON-OFF	8W	IP20	200mA		

		LED					SISTEMA-SYSTEM			
		Ⓜ	Ⓛm	Ⓥ	Ⓚ	ⓈR	Ⓜ	Ⓛm	ⓈR	
	KIT APPARECCHIO + ALIMENTATORE - FITTING + DRIVER									
	Br	KT2868-LBC	7W	830	200mA	3000	>90	8W	365	46
	Ne	KT2869-LBC								
	Br	KT2868-LBN	7W	880	200mA	4000	>90	8W	388	49
	Ne	KT2869-LBN								
	Gr	KT2870-LBN								

OP. A richiesta - On request: Led con temperatura di COLORE 2700K - Temperature Led COLOUR 2700K
disponibile - available



* Solo apparecchio - Only fitting

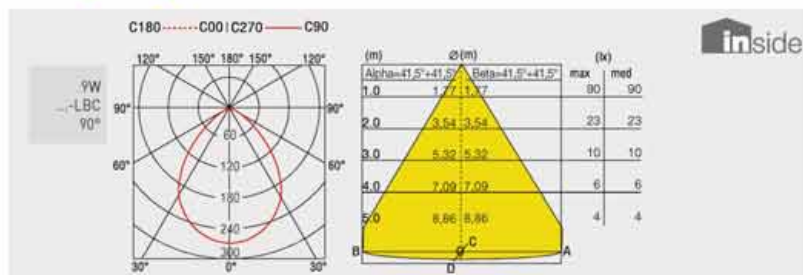

ALIMENTATORI-KIT RGB (se non in dotazione) da ordinare dalla sezione arancio - DRIVERS-RGB KITS (when not supplied) to be ordered from the section orange color



- Corpo in pressofusione di alluminio verniciato.
- Verniciatura in polveri di poliestere.
- Schermo di protezione in policarbonato.
- Led durata utile: 50.000 (h) L80 B10.

- Body made of painted die-cast aluminum.
- Polyester powder coating.
- Coating protection screen polycarbonate.
- Led life: 50.000 (h) L80 B10.

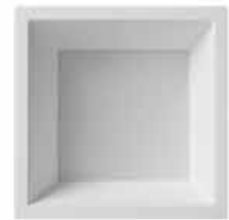

93x93 mm 1±30 mm

	W	lm	V	K	CRI
Br 2860-LBC Ne 2861-LBC Ga 2862-LBC	11,5W	1680	350mA	3000	>90
Br 2860-LBN Ne 2861-LBN Ga 2862-LBN	11,5W	1810	350mA	4000	>90

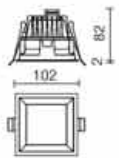

ALIMENTATORI CONSIGLIATI - DRIVERS RECOMMENDED

644759-1	IP20	15W	350mA
645673	IP65	18W	350mA

	LED					SISTEMA-SYSTEM		
	W	lm	V	K	CRI	W	lm	lm/W
KIT APPARECCHIO • ALIMENTATORE - FITTING • DRIVER Br KT2860-LBC Ne KT2861-LBC Gr KT2862-LBC	11,5W	1680	220-240V (350mA)	3000	>90	13,5W	1057	78
Br KT2860-LBN Ne KT2861-LBN Gr KT2862-LBN	11,5W	1810	220-240V (350mA)	4000	>90	13,5W	1139	84

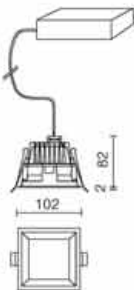

OP. A richiesta - On request: Led con temperatura di COLORE 2700K - Temperature Led COLOUR 2700K
disponibile - available

ACC. 148-Q Contenitore per solette in calcestruzzo - Container for concrete slabs

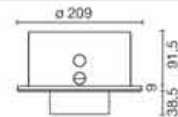

* Solo apparecchio - Only fitting

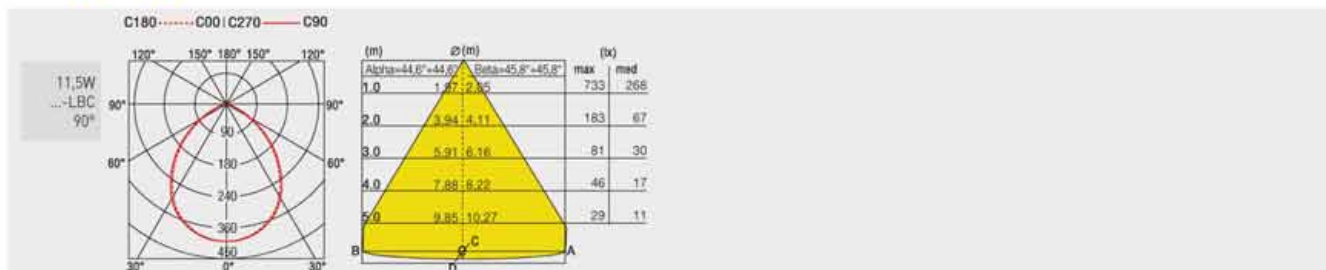

ALIMENTATORI-KIT RGB (se non in dotazione) da ordinare dalla sezione arancio - DRIVERS-RGB KITS (when not supplied) to be ordered from the section orange color





- Corpo in pressofusione di alluminio verniciato.
- Verniciatura in polveri di poliestere.
- Schermo di protezione in policarbonato.
- Led durata utile: 50.000 (h) L80 B10.
- Consistenza cromatica: 3 SDCM.
- Body made of painted die-cast aluminum.
- Polyester powder coating.
- Coating protection screen polycarbonate.
- Led life: 50.000 (h) L80 B10.
- Chromatic consistency: 3 SDCM.



136x136 mm Δ 0±20 mm

		W	lm	V	K	CRI
	Br 2875-LBC					
	Ne 2876-LBC	24W	3180	700mA	3000	>90
	Ga 2877-LBC					
	Br 2875-LBN					
	Ne 2876-LBN	24W	3430	700mA	4000	>90
	Ga 2877-LBN					

ALIMENTATORI CONSIGLIATI - DRIVERS RECOMMENDED

644936	ON-OFF	25W	IP40	700mA
644757	PUSH 1- 10V	35W	IP20	350/900mA
644757-DA	DIM DALI			700mA

		LED					SISTEMA-SYSTEM		
		W	lm	V	K	CRI	W	lm	lm/W
	KIT APPARECCHIO + ALIMENTATORE - FITTING + DRIVER								
	Br KT2875-LBC	24W	3180	220-240V [700mA]	3000	>90	27W	2219	82
	Ne KT2876-LBC								
	Gr KT2877-LBC								
	Br KT2875-LBN	24W	3430	220-240V [700mA]	4000	>90	27W	2394	87
	Ne KT2876-LBN								
	Gr KT2877-LBN								

OP. A richiesta - On request: Led con temperatura di COLORE 2700K - Temperature Led COLOUR 2700K
disponibile - available



* Solo apparecchio - Only fitting

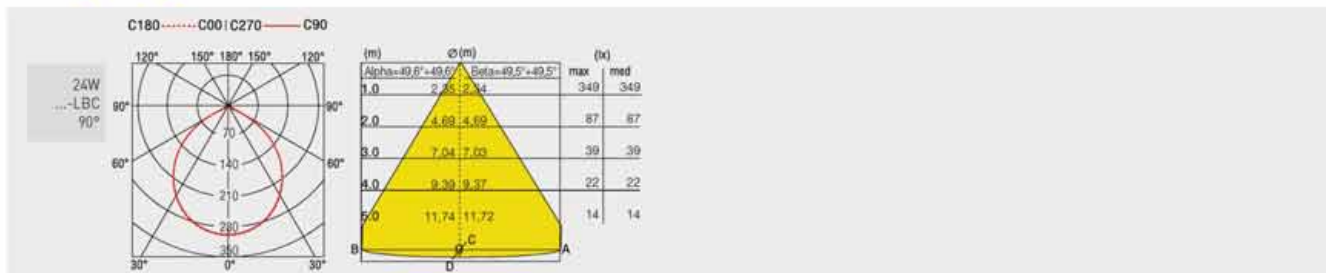

ALIMENTATORI-KIT RGB (se non in dotazione) da ordinare dalla sezione arancio - DRIVERS-RGB KITS (when not supplied) to be ordered from the section orange color





- Anello e telaio reggivetrol in pressofusione di alluminio verniciato in polveri.
- Riflettore in alluminio purissimo.
- Vetro di protezione trasparente, dissipatore alettato in alluminio.
- Luce bianca 4000°K, bianco caldo 3000°K senza emissione IR o UV.
- Led durata utile: 35.000 (h) L70 B50 ON-OFF.
- Led durata utile: 50.000 (h) L70 B50 DALI.
- Consistenza cromatica: <5MCE .

- Ring and glass-holder frame made of die-cast aluminium, powder painted.
- Pure aluminium reflector.
- Transparent protection glass, aluminium heatsink.
- White light 4000°K, warm white 3000°K without IR or UV emission.
- Led life: 35.000 (h) L70 B50 ON-OFF.
- Led life: 50.000 (h) L70 B50 DALI.
- Chromatic consistency: <5MCE .



225x225 mm Δ 5+30 mm

	LED	SISTEMA-SYSTEM						
		W	lm	V	K	CRI	W	lm
Br 4194 Ga 4195	20W 2000	220-240V	3000	>80	20W	1493	75	
Br 4196 Ga 4197	20W 2000	220-240V	4000	>80	20W	1493	75	
Br 4200 Ga 4201	30W 3000	220-240V	3000	>80	30W	2239	75	
Br 4198 Ga 4199	30W 3000	220-240V	4000	>80	30W	2239	75	

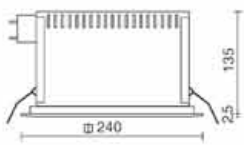

1kg
2.90

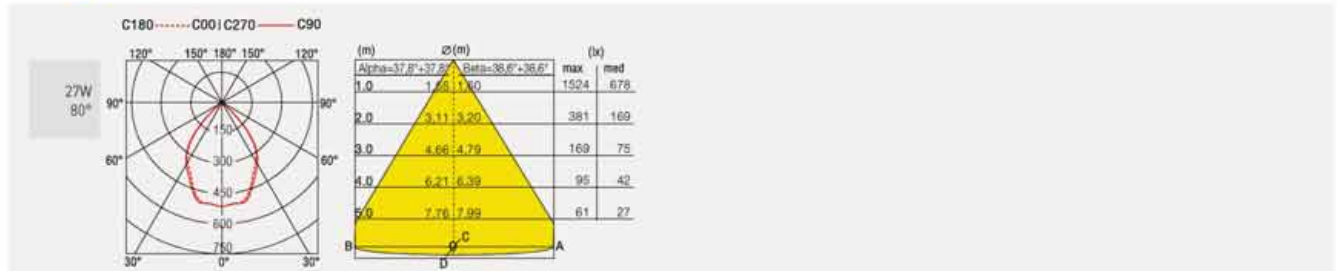

ALIMENTATORI-KIT RGB (se non in dotazione) da ordinare dalla sezione arancio - DRIVERS-RGB KITS (when not supplied) to be ordered from the section orange color





LUCE DIFFUSA - FLOODLIGHTING
SEZIONE QUADRA - SQUARE SECTION

DOMINO SC
SENZA CORNICE - TRIMLESS

- Corpo in metallo verniciato.
- Gruppo di alimentazione integrato.
- Diffusore in policarbonato opalino in dotazione.

- Housing of painted metal.
- Built-in power supply unit.
- Opal polycarbonate diffuser supplied.



DOMINO SC XS

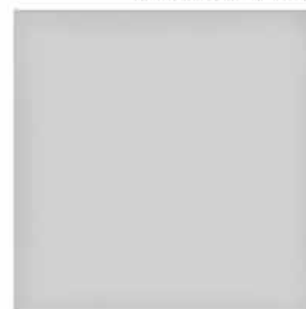

DOMINO SC XL

	LED	SISTEMA-SYSTEM						
		W	lm	lm/W				
<p>DOMINO SC XS 4152-LBC 4152-LBN</p>	W	Im	V	K	CRI	W	lm	lm/W
	13W	1700 1740	220-240V [700mA]	3000 4000	>90	15W	1359 1477	90 98

	LED	SISTEMA-SYSTEM						
		W	Im	lm/W				
<p>DOMINO SC XL 4162-LBC 4162-LBN</p>	W	Im	V	K	CRI	W	lm	lm/W
	19,4W	2320 2440	220-240V [700mA]	3000 4000	>90	22,4W	1456 1548	65 69

ACC. A richiesta: versione in emergenza aggiungendo il Kit - On request: emergency version adding Kit
INV 1052 Kit 1h
INV 1052-3 Kit 3h

OP. A richiesta - On request: disponibile - available



RASAMENTO A FILO CARTONGESSO - PLASTERBOARD FLAT FINISHING

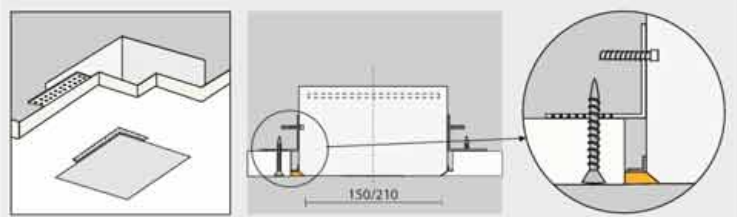

ALIMENTATORI-KIT RGB (se non in dotazione) da ordinare dalla sezione arancio - DRIVERS-RGB KITS (when not supplied) to be ordered from the section orange color

inside





- Incasso fisso rettangolare per controsoffitti.
- Corpo e struttura in lamiera verniciata.
- Vetro di protezione opalino.
- Verniciatura per interni in polveri epossidiche.
- Fixed recessed fitting for false-ceilings.
- Body and housing made of painted sheet metal.
- Opal protection glass.
- Indoor epoxy powder coated.



420x208 mm Δ 0-50 mm

	BI	GR	RL4200-LBC	RL4201-LBC	LED					SYSTEM-SYSTEM		
					W	lm	V	K	CRI	W	lm	lm/W
	BI	GR	RL4200-LBC	RL4201-LBC	tot. 35W SMD	3150	220-240V [700mA]	3000	>90	39W	2033	52
	BI	GR	RL4200-LBN	RL4201-LBN	tot. 35W SMD	3500	220-240V [700mA]	4000	>90	39W	2236	57
	BI	GR	RL4200-LBI	RL4201-LBI	tot. 35W SMD	3500	220-240V [700mA]	6000	>90	39W	2236	57

ACC. A richiesta: versione in emergenza aggiungendo il Kit - On request: emergency version adding Kit
INV 1052 Kit 1h
INV 1052-3 Kit 3h

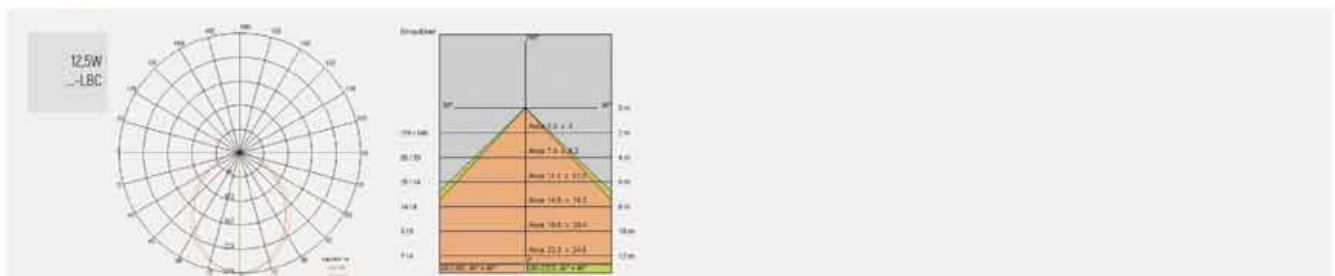

ALIMENTATORI-KIT RGB (se non in dotazione) da ordinare dalla sezione arancio - DRIVERS-RGB KITS (when not supplied) to be ordered from the section orange color

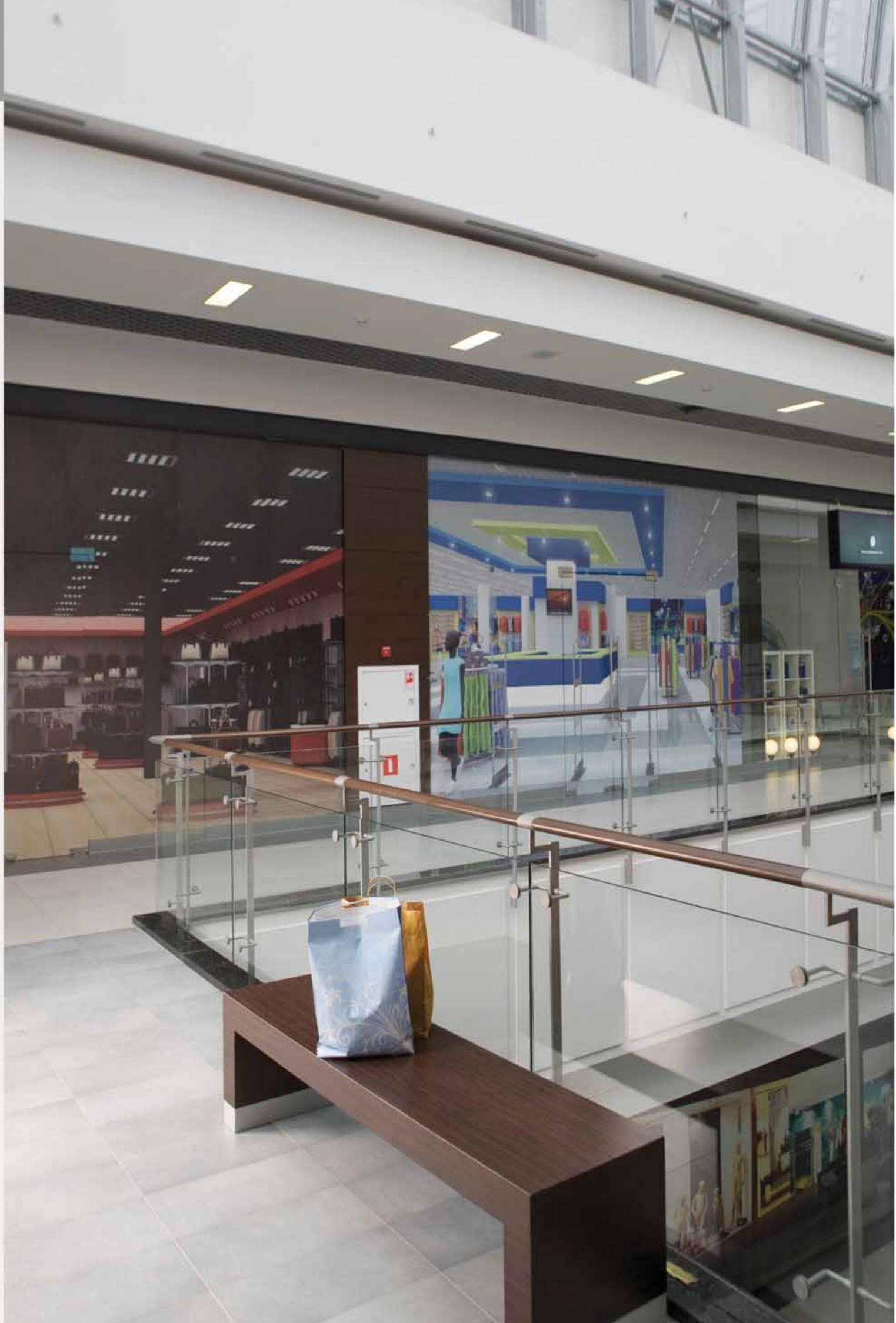



260x125 mm Δ 1-30 mm

- Corpo in materiale termoplastico.
- Vano ottico in alluminio EN AB-47100.
- Verniciatura per interni in polveri epossidiche.
- Schermo diffusore in policarbonato.
- Riflettore in alluminio purissimo 99,8%.
- Fermacavo in nylon 66.
- Molle a filo in acciaio.
- Durata nominale: 50000 (h) L80 B20.
- Consistenza cromatica: 3 SDCM.

- Body in thermoplastic material.
- Optic tray in aluminium EN AB-47100.
- Indoor epoxy powder painting.
- Polycarbonate screen diffuser.
- Pure aluminium 99,8% reflector.
- Cable clamp of nylon 66.
- Springs steel wire.
- Led life: 50.000 (h) L90 B50.
- Chromatic consistency: 3 SDCM.

	Bi	Ne	LED					SISTEMA-SYSTEM		
			W	lm	V	K	CRI	W	lm	lm/W
	60110-LBC	60111-LBC	12,5W	1630	220-240V (500mA)	3000	>90	14,5W	1190	82
	60110-LBN	60111-LBN	12,5W	1760	220-240V (500mA)	4000	>90	14,5W	1285	87

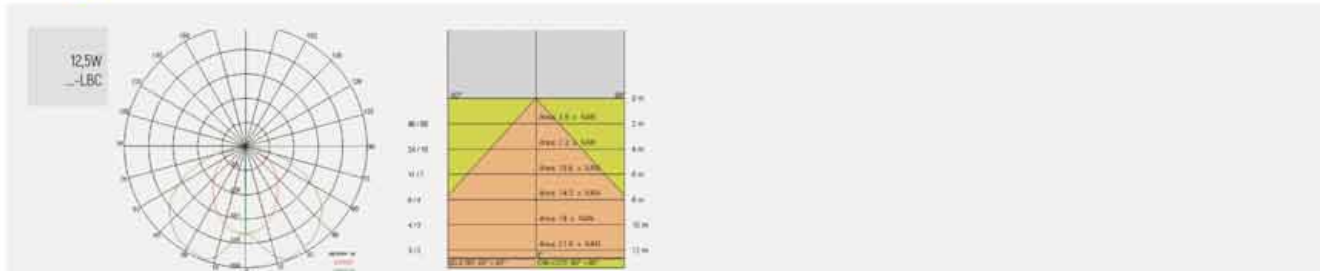
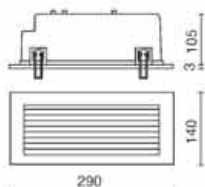

ALIMENTATORI-KIT RGB (se non in dotazione) da ordinare della sezione arancio - DRIVERS-RGB KITS (when not supplied) to be ordered from the section orange color



FASCIO STANDARD - STANDARD BEAM

RGB ≤ 19

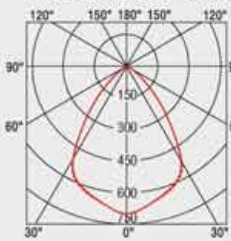

(m)	\varnothing (m)	(lx)	
		max	med
1.0	1.48 : 1.48	4147	1983
2.0	2.95 : 2.95	1037	496
3.0	4.43 : 4.43	461	220
4.0	5.91 : 5.91	259	124
5.0	7.38 : 7.38	166	79

C180 C00 | C270 — C90

FASCIO DOPPIO ASIMMETRICO - DOUBLE ASYMMETRIC BEAM

RGB ≤ 19

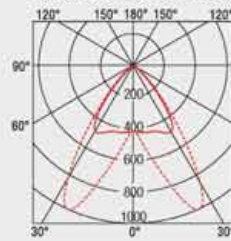

(m)	\varnothing (m)	(lx)	
		max	med
1.0	0.00 : 0.01	4483	2700
2.0	1.20 : 1.80	1121	675
3.0	1.85 : 2.74	498	300
4.0	2.40 : 3.65	280	169
5.0	3.00 : 4.56	179	108

C180 C00 | C270 — C90

FASCIO DIFFUSO - DIFFUSED OPTIC

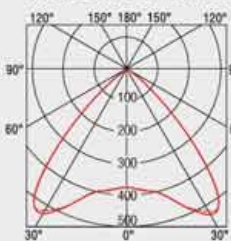

(m)	\varnothing (m)	(lx)	
		max	med
1.0	1.93 : 1.92	2374	1333
2.0	3.85 : 3.84	594	333
3.0	5.78 : 5.77	264	148
4.0	7.70 : 7.69	148	83
5.0	9.63 : 9.61	95	53

FASCIO ASIMMETRICO - ASYMMETRIC BEAM

RGB ≤ 19

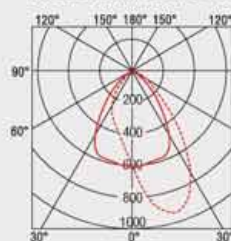

(m)	\varnothing (m)	(lx)	
		max	med
1.0	0.63 : 1.21	4846	2509
2.0	1.26 : 2.43	1211	627
3.0	2.79 : 3.64	538	279
4.0	3.72 : 4.85	303	157
5.0	4.66 : 6.07	194	100



- Corpo in materiale termoplastico.
- Lente in PMMA.
- Dissipatore passivo.
- Temperatura esercizio -20° +35°.
- Pressacavo in nylon 66.
- Apparecchio conforme alle norme EN60598-1.
- Led durata utile: 50.000 [h] L80 B10.
- Consistenza cromatica: 3 SDCM.

- Body in thermoplastic material.
- PMMA lens.
- Passive heatsink.
- Operating temperature -20 ° + 35 °.
- Cable gland in nylon 66.
- Nylon cable gland 66.
- Fitting compliant to EN60598-1 standards.
- Led life: 50.000 [h] L80 B20.
- Chromatic consistency: 3 SDCM.



					LED					SISTEMA-SYSTEM		
					W	lm	V	K	CRI	W	lm	lm
ON-OFF												
Br	4455-LBC	4457-LBC	4459-LBC	4461-LBC	43,2W	7020	220-240V	3000	>90	47,5W	6894	144
Ne	4456-LBC	4458-LBC	4460-LBC	4462-LBC			[500mA]					
Br	4455-LBN	4457-LBN	4459-LBN	4461-LBN	43,2W	7365	220-240V	4000	>90	47,5W	7233	151
Ne	4456-LBN	4458-LBN	4460-LBN	4462-LBN			[500mA]					
DALI DIM-DALI/PUSH												
DALI DIM-DALI/PUSH												
Br	4455-LBC-DA	4457-LBC-DA	4459-LBC-DA	4461-LBC-DA	43,2W	7020	220-240V	3000	>90	47,5W	6894	144
Ne	4456-LBC-DA	4458-LBC-DA	4460-LBC-DA	4462-LBC-DA			[500mA]					
Br	4455-LBN-DA	4457-LBN-DA	4459-LBN-DA	4461-LBN-DA	43,2W	7365	220-240V	4000	>90	47,5W	7233	151
Ne	4456-LBN-DA	4458-LBN-DA	4460-LBN-DA	4462-LBN-DA			[500mA]					
EM EMERGENZA-EMERGENCY - 1H												
EM EMERGENZA-EMERGENCY - 1H												
Br	4455-LBC-EM	4457-LBC-EM	4459-LBC-EM	4461-LBC-EM	43,2W	7020	220-240V	3000	>90	47,5W	6894	144
Ne	4456-LBC-EM	4458-LBC-EM	4460-LBC-EM	4462-LBC-EM			[500mA]					
Br	4455-LBN-EM	4457-LBN-EM	4459-LBN-EM	4461-LBN-EM	43,2W	7365	220-240V	4000	>90	47,5W	7233	151
Ne	4456-LBN-EM	4458-LBN-EM	4460-LBN-EM	4462-LBN-EM			[500mA]					

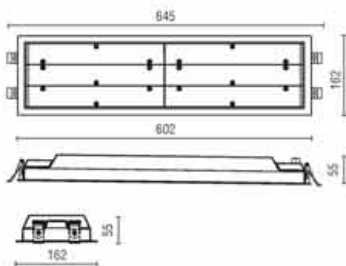

ALIMENTATORI-KIT RGB (se non in dotazione) da ordinare dalla sezione arancio - DRIVERS-RGB KITS (when not supplied) to be ordered from the section orange color



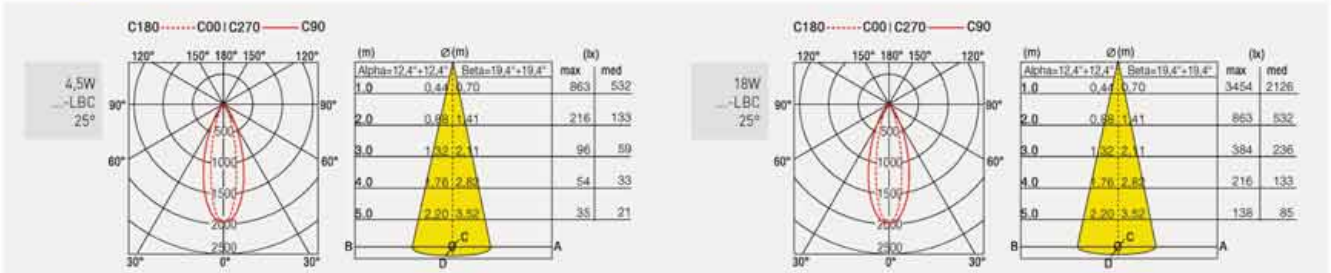
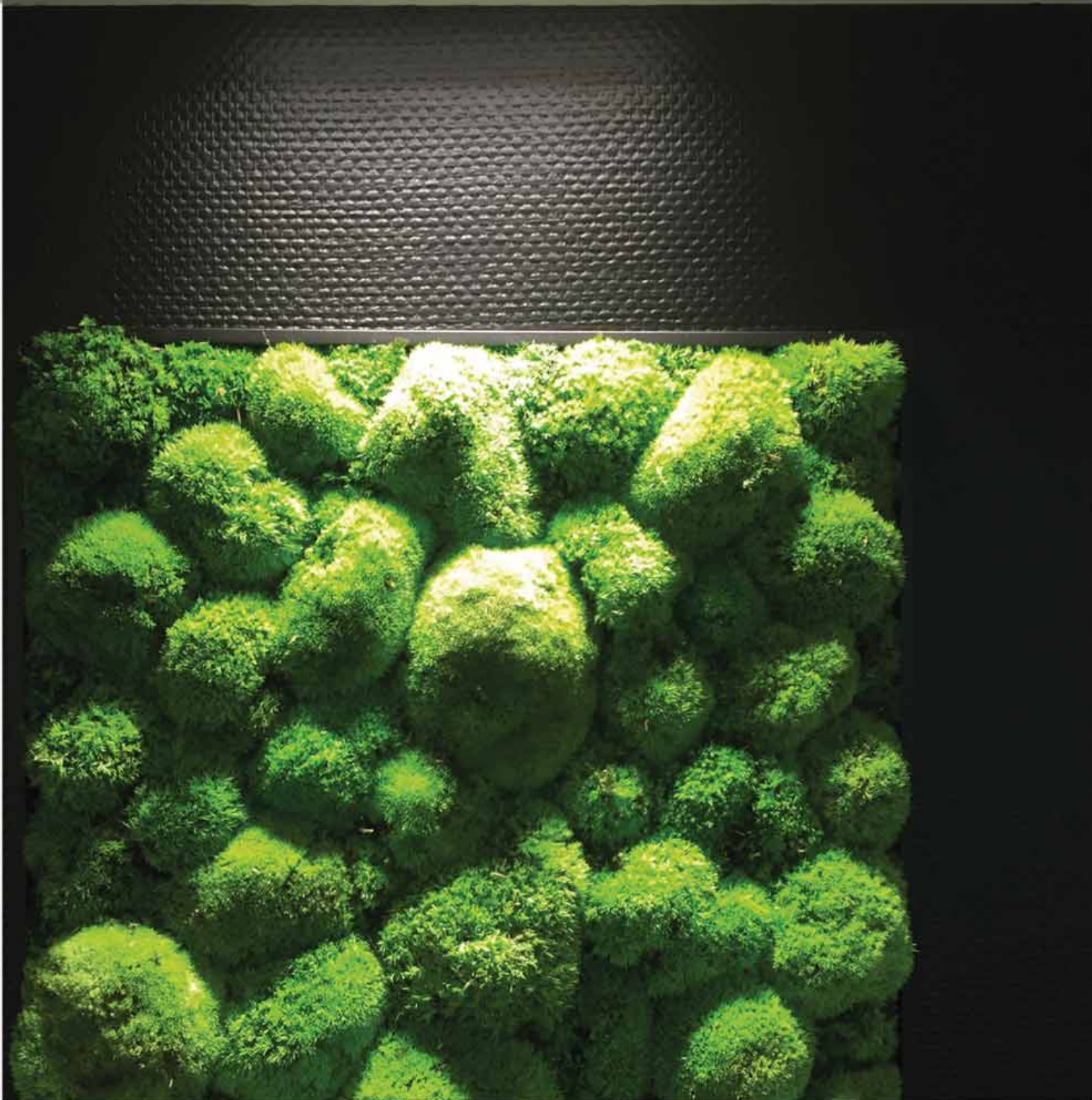

ALIMENTATORI-KIT RGB (se non in dotazione) da ordinare dalla sezione arancio - DRIVERS-RGB KITS (when not supplied) to be ordered from the section orange color

TRAIL INCASSO



- Corpo e testate in alluminio verniciato in polveri.
- Riflettore in policarbonato.
- Alimentatore in dotazione.
- Aluminium powder coated body and end caps.
- Polycarbonate reflector.
- Driver included.



INCASSO • RECESSED

	Kg	Br	LED					SISTEMA-SYSTEM			
			W	lm	V	K	CRI	W	lm	lm/W	
1 LED 36x38,5 mm Δ 5+30 mm	0,120		3710-LBC 3710-LBN	2W	150 160	220-240V [500mA]	3000 4000	>90	3W	120 130	40 43
3 LED 36x86,5 mm Δ 5+30 mm	0,155		3716-LBC 3716-LBN	4,5W	480 530	220-240V [500mA]	3000 4000	>90	5,5W	355 389	65 70
6 LED 36x162,5 mm Δ 5+30 mm	0,27		3719-LBC 3719-LBN	9W	960 1056	220-240V [500mA]	3000 4000	>90	10W	775 880	77 85
9 LED 36x236,5 mm Δ 5+30 mm	0,40		3722-LBC 3722-LBN	13,5W	1440 1584	220-240V [500mA]	3000 4000	>90	15,5W	1066 1260	69 82
12 LED 36x314 mm Δ 5+30 mm	0,65		3725-LBC 3725-LBN	18W	1920 2112	220-240V [500mA]	3000 4000	>90	21W	1551 1706	74 81

OR A richiesta - On request: disponibile - available multipli di 3 LED - multiples of 3 LED



$$UGR = 8 \log_{10} \left[\frac{0,25}{L_s} \sum \frac{L_s^2 \omega}{p^2} \right]$$





- Corpo in metallo verniciato.
- Verniciatura in polveri di poliestere.
- Led durata utile: 50.000 (h) L80 B20.

- Body of painted metal.
- Polyester powder coating
- Led life: 50.000 (h) L80 B20.

MATRIX MICRO COB



82x82 mm Δ 0±30 mm

INCASSI • RECESSED

			(W)	(lm)	(V)	(K)	(CRI)
 100 90 0,70	Bi 71106C-LBC-15	15	12,3W	1040	350mA	3000	>90
	Ga 71105C-LBC-15						
	Bi 71106C-LBN-15	15	12,3W	1120	350mA	4000	>90
	Ga 71105C-LBN-15						
	Bi 71106C-LBC-24	24	12,9W	1430	350mA	3000	>90
	Ga 71105C-LBC-24						
	Bi 71106C-LBN-24	24	12,9W	1510	350mA	4000	>90
	Ga 71105C-LBN-24						
	Bi 71106C-LBC-40	40	12,9W	1360	350mA	3000	>90
	Ga 71105C-LBC-40						
	Bi 71106C-LBN-40	40	12,9W	1430	350mA	4000	>90
	Ga 71105C-LBN-40						

ALIMENTATORI CONSIGLIATI - RECOMMENDED DRIVERS

644759-1	ON-OFF	15W	IP20	350mA
645984	ON-OFF	15W	IP40	350mA

OP. A richiesta - On request: disponibile - available

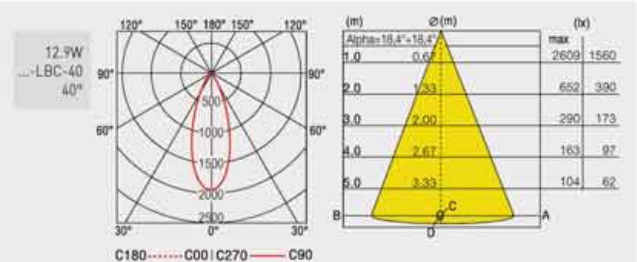
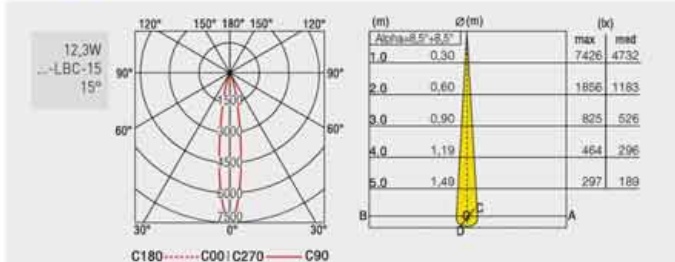





- Corpo in metallo verniciato.
- Verniciatura in polveri di poliestere.
- Gruppo ottico orientabile +/- 20°.

- Housing of painted metal.
- Polyester powder coating
- +/- 20° adjustable optic.

MULTI OTTICA – MULTIPLE OPTICS

MATRIX MICRO CS

SENZA CORNICE - TRIMLESS

121

INCASSI • RECESSED



MATRIX MICRO SC XS



MATRIX MICRO SC XL

		W	lm	V	K	CRI		
	Br	71106-MLBC-25 71106-MLBN-25	25	1x12,9W	1430 1510	350mA	3000 4000	>90
		0,60						
	Br	71111-MLBC-40 71111-MLBN-40	40	2x12,9W	1360 1430	350mA	3000 4000	>90
		0,94						

98x98 mm 5÷30 mm

		W	lm	V	K	CRI		
	Br	71111-MLBC-25 71111-MLBN-25	25	2x12,9W	2x1430 2x1510	350mA	3000 4000	>90
		0,94						
	Br	71111-MLBC-40 71111-MLBN-40	40	2x12,9W	2x1360 2x1430	350mA	3000 4000	>90
		0,94						

98x180 mm 5÷30 mm

ACC.	3035	Diffusore in vetro per monolampada - Glass diffuser one lamp
	3036	Diffusore in vetro per bilampada - Glass diffuser double lamp

RASAMENTO A FILO CARTONGESSO - PLASTERBOARD FLAT FINISHING

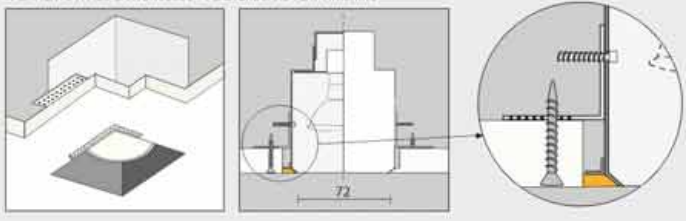

ALIMENTATORI-KIT RGB (se non in dotazione) da ordinare dalla sezione arancio - DRIVERS-RGB KITS (when not supplied) to be ordered from the section orange color





MATRIX MINI

- Corpo in metallo verniciato.
- Gruppo ottico estraibile ed orientabile +/- 20°.

- Housing of painted metal.
- +/- 20° adjustable and pull-out optic.

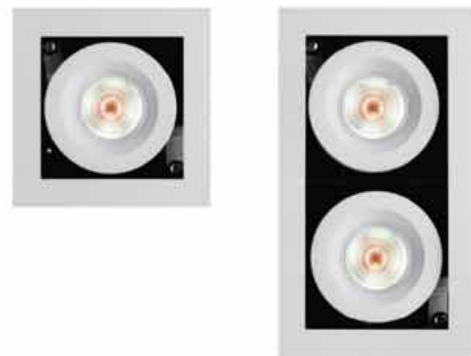

LED COB		W	lm	V	K	⚡	CRI
<p>118x118 mm Δ= 0+30 mm</p>	Bi 71131C-LBC-15 Ga 71130C-LBC-15	12,3W	1040	350mA	3000		>90
	Bi 71131C-LBN-15 Ga 71130C-LBN-15	12,3W	1120	350mA	4000		>90
	Bi 71131C-LBC-24 Ga 71130C-LBC-24	12,9W	1430	350mA	3000		>90
	Bi 71131C-LBN-24 Ga 71130C-LBN-24	12,9W	1510	350mA	4000		>90
	Bi 71131C-LBC-40 Ga 71130C-LBC-40	12,9W	1360	350mA	3000		>90
	Bi 71131C-LBN-40 Ga 71130C-LBN-40	12,9W	1430	350mA	4000		>90
<p>210x118 mm Δ= 0+30 mm</p>	Bi 71136C-LBC-15 Ga 71135C-LBC-15	2x12,3W	2080	350mA	3000		>90
	Bi 71136C-LBN-15 Ga 71135C-LBN-15	2x12,3W	2240	350mA	4000		>90
	Bi 71136C-LBC-24 Ga 71135C-LBC-24	2x12,9W	2860	350mA	3000		>90
	Bi 71136C-LBN-24 Ga 71135C-LBN-24	2x12,9W	3020	350mA	4000		>90
	Bi 71136C-LBC-40 Ga 71135C-LBC-40	2x12,9W	2720	350mA	3000		>90
	Bi 71136C-LBN-40 Ga 71135C-LBN-40	2x12,9W	2860	350mA	4000		>90

ALIMENTATORI CONSIGLIATI - RECOMMENDED DRIVERS

644759-1	ON-OFF	15W	IP20	350mA
645984	ON-OFF	15W	IP40	350mA

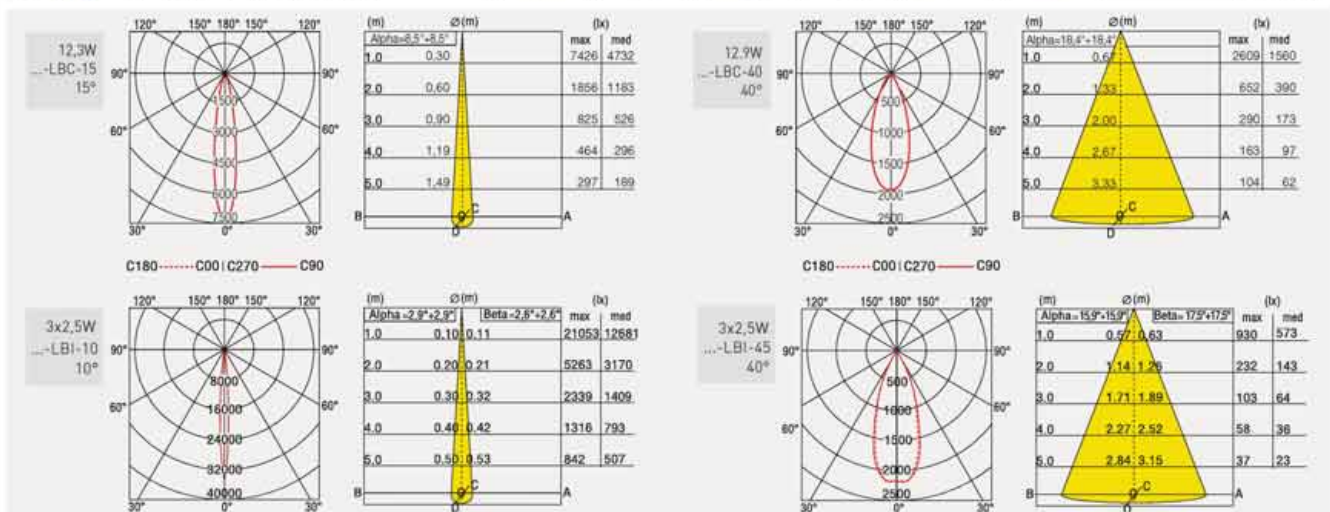



		W	lm	V	K	CRI	
<p>118x118 mm Δ 0+30 mm</p>	 Ga 71130-LBC-10 Bi 71131-LBC-10	3x12W 3x2,5W	240 410	350mA 700mA	3000	>90	
	Ga 71130-LBI-10 Bi 71131-LBI-10	3x12W 3x2,5W	300 510	350mA 700mA	6000	>90	
	 Ga 71130-LBL-10 Bi 71131-LBL-10	3x12W 3x2,5W	-	350mA 700mA	470nm	-	
	Ga 71130-RGB-10 Bi 71131-RGB-10	3x12W	-	350mA		-	
	<p>210x118 mm Δ 0+30 mm</p>	 Ga 71135-LBC-10 Bi 71136-LBC-10	6x12W 6x2,5W	2x240 2x410	350mA 700mA	3000	>90
		Ga 71135-LBI-10 Bi 71136-LBI-10	6x12W 6x2,5W	2x300 2x510	350mA 700mA	6000	>90
 Ga 71135-LBL-10 Bi 71136-LBL-10		6x12W 6x2,5W	-	350mA 700mA	470nm	-	
Ga 71135-RGB-10 Bi 71136-RGB-10		6x12W	-	350mA		-	

ALIMENTATORI CONSIGLIATI - RECOMMENDED DRIVERS

644758	ON-OFF	8W	IP20	350mA
644759-1	ON-OFF	15W	IP20	350mA
646427	ON-OFF	12W	IP20	350mA
644940	ON-OFF	12W	IP40	700mA
644936	ON-OFF	25W	IP40	700mA

OP. *A richiesta - On request: apertura fascio - light beam Δ -30 Δ -45

ACC. A richiesta: versione in emergenza aggiungendo il Kit - On request: emergency version adding Kit
 INV 1052 Kit 1h
 INV 1052-3 Kit 3h



MATRIX MINI

- Corpo in metallo verniciato.
- Gruppo ottico estraibile ed orientabile +/- 20°.
- Housing of painted metal.
- +/- 20° adjustable and pull-out optic.

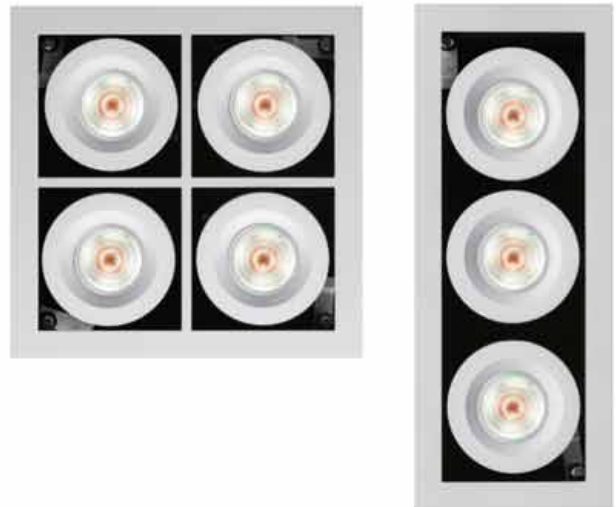





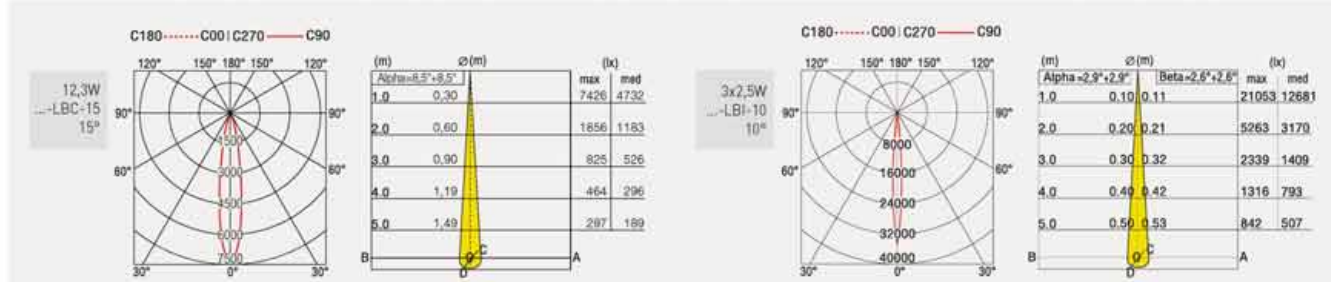

















LED COB			(W)	(lm)	(V)	(K)		(CRI)
	Bi	71116C-LBC-15	3x12,3W	3X1040	350mA	3000		>90
	Ga	71115C-LBC-15						
	Bi	71116C-LBN-15	3x12,3W	3X1120	350mA	4000		>90
	Ga	71115C-LBN-15						
	Bi	71116C-LBC-24	5x12,9W	3X1430	350mA	3000		>90
	Ga	71115C-LBC-24						
	Bi	71116C-LBN-24	3x12,9W	3X1510	350mA	4000		>90
	Ga	71115C-LBN-24						
	Bi	71116C-LBC-40	3x12,9W	3X1360	350mA	3000		>90
	Ga	71115C-LBC-40						
	Bi	71116C-LBN-40	3x12,9W	3X1430	350mA	4000		>90
	Ga	71115C-LBN-40						
	Bi	71121C-LBC-15	4x12,3W	4X1040	350mA	3000		>90
	Ga	71120C-LBC-15						
	Bi	71121C-LBN-15	4x12,3W	4X1120	350mA	4000		>90
	Ga	71120C-LBN-15						
	Bi	71121C-LBC-24	4x12,9W	4X1430	350mA	3000		>90
	Ga	71120C-LBC-24						
	Bi	71121C-LBN-24	4x12,9W	4X1510	350mA	4000		>90
	Ga	71120C-LBN-24						
	Bi	71121C-LBC-40	4x12,9W	4X1360	350mA	3000		>90
	Ga	71120C-LBC-40						
	Bi	71121C-LBN-40	4x12,9W	4X1430	350mA	4000		>90
	Ga	71120C-LBN-40						

ALIMENTATORI CONSIGLIATI - RECOMMENDED DRIVERS			
644759-1	ON-OFF	15W	IP20 350mA
645984	ON-OFF	15W	IP40 350mA
645658	ON-OFF	35W	IP20 350mA

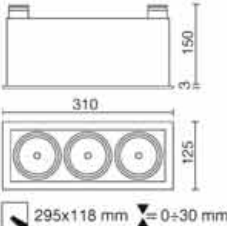

ALIMENTATORI-KIT RGB (se non in dotazione) da ordinare dalla sezione arancio - DRIVERS-RGB KITS (when not supplied) to be ordered from the section orange color

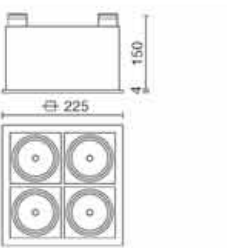

																			
 <p>295x118 mm $\Delta = 0 \pm 30$ mm</p>	Ga	71115-LBC-10	9x1,2W	3X240	350mA	3000	>90												
	Bi	71116-LBC-10	9x2,5W	3X410	700mA														
	Ga	71115-LBI-10	9x1,2W	3X300	350mA	6000	>90												
	Bi	71116-LBI-10	9x2,5W	3X510	700mA														
	Ga	71115-LBL-10	9x1,2W	-	350mA	470nm	-												
	Bi	71116-LBL-10	9x2,5W	-	700mA														
Ga	71115-RGB-10		9x1,2W	-	350mA		-												
Bi	71116-RGB-10																		
 <p>210x118 mm $\Delta = 0 \pm 30$ mm</p>	Ga	71120-LBC-10	12x1,2W	4X240	350mA	3000	>90												
	Bi	71121-LBC-10	12x2,5W	4X410	700mA														
	Ga	71120-LBI-10	12x1,2W	4X300	350mA	6000	>90												
	Bi	71121-LBI-10	12x2,5W	4X510	700mA														
	Ga	71120-LBL-10	12x1,2W	-	350mA	470nm	-												
	Bi	71121-LBL-10	12x2,5W	-	700mA														
Ga	71120-RGB-10		12x1,2W	-	350mA		-												
Bi	71121-RGB-10																		

ALIMENTATORI CONSIGLIATI - RECOMMENDED DRIVERS

644758	ON-OFF	8W	IP20	350mA
644759-1	ON-OFF	15W	IP20	350mA
646427	ON-OFF	12W	IP20	350mA
644940	ON-OFF	12W	IP40	700mA
644936	ON-OFF	25W	IP40	700mA

DP. *A richiesta - On request: apertura fascio - light beam \dots -30  \dots -45 

ACC. A richiesta: versione in emergenza aggiungendo il Kit - On request: emergency version adding Kit
 INV 1052 Kit 1h
 INV 1052-3 Kit 3h



* Lampada Dimmerabile - Dimmable lamp

L PREVALED COIN 111 DC COB G2											T Alimentatori consigliati Recommended drivers			
Marca Brand	Codice Code	Watt	Volt mA	Attacco Socket	Fascio Beam	Lumen	Cd* Cd*	Kelvin	Vita Media Average Life		Codice Code	Watt		n° max lamp
OSRAM 	646338-930	26W	700mA	-	15°	2350	-	3000K	-		646349-1	30W		1
	646338-940	26W	700mA	-	15°	2500	-	4000K	-					
	646339-930	26W	700mA	-	24°	2250	-	3000K	-					
	646339-940	26W	700mA	-	24°	2400	-	4000K	-					
	646340-930	26W	700mA	-	40°	2150	-	3000K	-					
	646340-940	26W	700mA	-	40°	2300	-	4000K	-					
	646347-930	37W	1050mA	-	24°	2450	-	3000K	-		646168-1	40W		1
	646347-940	37W	1050mA	-	24°	3800	-	4000K	-					
	646348-930	37W	1050mA	-	40°	3350	-	3000K	-					
	646348-940	37W	1050mA	-	40°	3550	-	4000K	-					

ALIMENTATORI-KIT RGB (se non in dotazione) da ordinare dalla sezione arancio - DRIVERS-RGB KITS (when not supplied) to be ordered from the section orange color

MATRIX

INCASSI • RECESSED



- Corpo, staffe e cornice in metallo verniciato, ghiera in alluminio pressofuso.
 - Verniciatura in polveri di poliestere.
 - Gruppo ottico orientabile.
 - Led durata utile: 50.000 (h) L80 B20.
- Housing, bracket and frame of painted metal, trim of die-cast aluminium.
 - Polyester powder coating
 - Adjustable optics.
 - Led life: 50.000 (h) L80 B20.

		Gr 70100 Bl 70101	LED 111	1x	G53
165x165 mm Δ 0±50 mm					



		Gr 70200 Bl 70201	LED 111	2x	G53
295x165 mm Δ 0±50 mm					



		Gr 70300 Bl 70301	LED 111	3x	G53
435x165 mm Δ 0±50 mm					



		Gr 70410 Bl 70411	LED 111	4x	G53
295x295 mm Δ 0±50 mm					



Gli apparecchi non sono muniti né di lampada né di alimentatore indipendente che potranno essere ordinati a SIDE a seconda del tipo di fascio e di potenza desiderata. The fittings are not equipped with led lamp neither independent driver. Both of them can be ordered to SIDE depending on the type of beam and the required power.

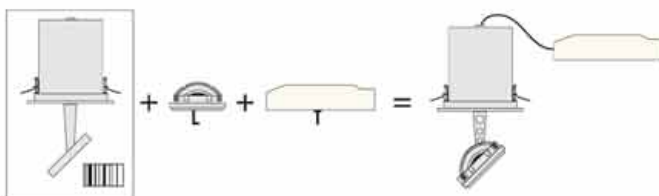

L LAMPADE LED CONSIGLIATE - RECOMMENDED LED LAMPS

646339-930	26W	700mA	3000K	
646347-930	37W	1050mA	3000K	

T ALIMENTATORI CONSIGLIATI - RECOMMENDED DRIVERS

646349-1	30W
646168-1	40W



ALIMENTATORI-KIT RGB (se non in dotazione) da ordinare dalla sezione arancio - DRIVERS-RGB KITS (when not supplied) to be ordered from the section orange color





* Lampada Dimmerabile - Dimmable lamp

L PREVALED COIN 111 DC COB G2											T Alimentatori consigliati Recommended drivers			
Marca Brand	Codice Code	Watt	Volt mA	Attacco Socket	Fascio Beam	Lumen	Cd*	Kelvin	Vita Media Average Life		Codice Code	Watt		n° max lamp
OSRAM 	646338-930	26W	700mA	-	15°	2350	-	3000K	-		646349-1	30W		1
	646338-940	26W	700mA	-	15°	2500	-	4000K	-					
	646339-930	26W	700mA	-	24°	2250	-	3000K	-					
	646339-940	26W	700mA	-	24°	2400	-	4000K	-					
	646340-930	26W	700mA	-	40°	2150	-	3000K	-					
	646340-940	26W	700mA	-	40°	2300	-	4000K	-					
	646347-930	37W	1050mA	-	24°	2450	-	3000K	-		646168-1	40W		1
	646347-940	37W	1050mA	-	24°	3800	-	4000K	-					
	646348-930	37W	1050mA	-	40°	3350	-	3000K	-					
	646348-940	37W	1050mA	-	40°	3550	-	4000K	-					

ALIMENTATORI-KIT RGB (se non in dotazione) da ordinare dalla sezione arancio - DRIVERS-RGB KITS (when not supplied) to be ordered from the section orange color

MATRIX SC
SENZA CORNICE - TRIMLESS

INCASSI • RECESSED



- Corpo e staffe in metallo verniciato, ghiera in alluminio pressofuso.
- Verniciatura in polveri di poliestere.
- Gruppo ottico orientabile.
- Led durata utile: 50.000 (h) L80 B20.

- Housing and bracket of painted metal, trim of die-cast aluminium.
- Polyester powder coating
- Adjustable optics.
- Led life: 50.000 (h) L80 B20.

Skg 1,10	Gr	70100-SC	LED T11	1x	G53
	Bl	70101-SC			

155x155 mm $\Delta = 0 \pm 50$ mm



Skg 2,60	Gr	70200-SC	LED T11	2x	G53
	Bl	70201-SC			

285x155 mm $\Delta = 0 \pm 50$ mm



Skg 3,00	Gr	70300-SC	LED T11	3x	G53
	Bl	70301-SC			

430x155 mm $\Delta = 0 \pm 50$ mm



Skg 3,80	Gr	70410-SC	LED T11	4x	G53
	Bl	70411-SC			

285x255 mm $\Delta = 0 \pm 50$ mm



Gli apparecchi non sono muniti né di lampada né di alimentatore indipendente che potranno essere ordinati a SIDE a seconda del tipo di fascio e di potenza desiderata.
The fittings are not equipped with led lamp neither independent driver. Both of them can be ordered to SIDE depending on the type of beam and the required power.

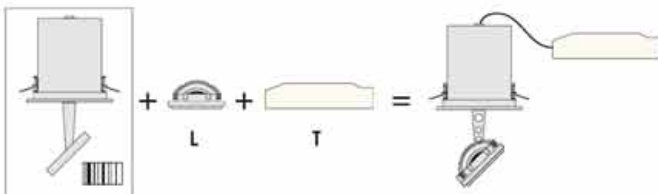

L LAMPADINE LED CONSIGLIATE - RECOMMENDED LED LAMPS

646339-930	26W	700mA	3000K	
646347-930	37W	1050mA	3000K	

T ALIMENTATORI CONSIGLIATI - RECOMMENDED DRIVERS

646349-1	30W
646168-1	40W



ALIMENTATORI-KIT RGB (se non in dotazione) da ordinare dalla sezione arancio - DRIVERS-RGB KITS (when not supplied) to be ordered from the section orange color





MATRIX POWER

- Corpo e cornice in metallo verniciato.
- Ghiera e snodo cardanico in alluminio pressofuso.
- Fissaggio a controsoffitto con staffe regolabili.
- Gruppo ottico orientabile +/- 30° su asse orizzontale e verticale.
- Parabola in alluminio purissimo ossidata.
- Raffreddamento Led passivo con dissipatore.

- Body and frame in painted metal.
- Trim and cardan junction in die-cast aluminium.
- False-ceiling fixing with adjustable brackets.
- Optic group adjustable +/- 30° on both horizontal-vertical axes.
- Pure oxidized aluminium reflector.
- Passive cooling Led with dissipator.



180x180 mm Δ 0=30 mm



180x339 mm Δ 0=30 mm



			LED					SISTEMA-SYSTEM			
			W	lm	V	K	CRI	W	lm	IP	
<p>196</p> <p>178</p> <p>85</p> <p>196</p> <p>220x85</p> <p>2,50</p>	Ga	70500-LBC-30	70500-LBC-60	1x24W	3365	220-240V (700mA)	3000	>90	27W	2689	99
	Br	70501-LBC-30	70501-LBC-60								
	Ga	70500-LBI-30	70500-LBI-60	1x24W	3570	220-240V (700mA)	4000	>90	27W	2852	106
	Br	70501-LBI-30	70501-LBI-60								
	Ga	70505-LBC-30	70505-LBC-60	1x37W	4740	220-240V (1050mA)	3000	>90	41W	4304	105
	Br	70506-LBC-30	70506-LBC-60								
versione-version PLUS											
<p>356</p> <p>174.5</p> <p>85</p> <p>196</p> <p>220x85</p> <p>2X</p> <p>4,50</p>	Ga	70510-LBC-30	70510-LBC-60	1x43W	5280	220-240V (1200mA)	3000	>90	47W	4510	96
	Ga	70511-LBC-30	70511-LBC-60								
	Br	70510-LBI-30	70510-LBI-60	1x43W	5520	220-240V (1200mA)	4000	>90	47W	4673	99
	Br	70511-LBI-30	70511-LBI-60								
	Ga	70600-LBC-30	70600-LBC-60	2x24W	2x3365	220-240V (700mA)	3000	>90	2x27W	5377	99
	Br	70601-LBC-30	70601-LBC-60								
<p>356</p> <p>186</p> <p>85</p> <p>196</p> <p>220x85</p> <p>2X</p> <p>4,50</p> <p>40°</p>	Ga	70600-LBI-30	70600-LBI-60	2x24W	2x3570	220-240V (700mA)	4000	>90	2x27W	5705	106
	Br	70601-LBI-30	70601-LBI-60								
	Ga	70605-LBC-30	70605-LBC-60	2x37W	2x4740	220-240V (1050mA)	3000	>90	2x41W	8608	105
	Br	70606-LBC-30	70606-LBC-60								
	Ga	70605-LBI-30	70605-LBI-60	2x37W	2x4970	220-240V (1050mA)	4000	>90	2x41W	9026	110
	Br	70606-LBI-30	70606-LBI-60								
versione-version PLUS											
<p>356</p> <p>186</p> <p>85</p> <p>196</p> <p>220x85</p> <p>2X</p> <p>4,50</p> <p>40°</p>	Br	70615-LBC-30	70615-LBC-60	2x43W	2x5280	220-240V (1200mA)	3000	>90	2x47W	9020	96
	Ga	70616-LBC-30	70616-LBC-60								
	Br	70615-LBI-30	70615-LBI-60	2x43W	2x5520	220-240V (1200mA)	4000	>90	2x47W	9346	99
	Ga	70616-LBI-30	70616-LBI-60								

OP. Versione in emergenza SA (sempre acceso) solo per modello da 2000 lumen - Autonomia 1h - Flusso luminoso 20%
Version for SA (always on) emergency for 2000 lumen fitting - Working time 1h - Luminous flux 20%
A richiesta - On request: Led con temperatura di colore 2700K - Temperature Led colour 2700K

ACC. A richiesta: versione in emergenza aggiungendo il Kit - On request: emergency version adding Kit
INV 1052 Kit 1h
INV 1052-3 Kit 3h





			LED					SISTEMA-SYSTEM			
			W	lm	V	K	CRI	W	lm	lm/W	
	DALI										
	Ga	70500LBC30-DA	70500LBC60-DA	24W	3365	220-240V (700mA)	3000	>90	27W	2689	99
	Br	70501LBC30-DA	70501LBC60-DA								
	Ga	70500LBI30-DA	70500LBI60-DA	24W	3570	220-240V (700mA)	4000	>90	27W	2852	106
	Br	70501LBI30-DA	70501LBI60-DA								
	Ga	70505LBC30-DA	70505LBC60-DA	37W	4740	220-240V (1050mA)	3000	>90	41W	4241	103
Br	70506LBC30-DA	70506LBC60-DA									
Ga	70505LBI30-DA	70505LBI60-DA	37W	4970	220-240V (1050mA)	4000	>90	41W	4447	108	
Br	70506LBI30-DA	70506LBI60-DA									
versione-version PLUS											
Ga	70510LBC30-DA	70510LBC60-DA	43W	5280	220-240V (1200mA)	3000	>90	47W	4510	96	
Br	70511LBC30-DA	70511LBC60-DA									
Ga	70510LBI30-DA	70510LBI60-DA	43W	5520	220-240V (1200mA)	4000	>90	47W	4715	100	
Br	70511LBI30-DA	70511LBI60-DA									
	DALI										
	Ga	70600LBC30-DA	70600LBC60-DA	2x24W	2x3365	220-240V (700mA)	3000	>90	2x27W	6021	112
	Br	70601LBC30-DA	70601LBC60-DA								
	Ga	70600LBI30-DA	70600LBI60-DA	2x24W	2x3570	220-240V (700mA)	4000	>90	2x27W	6388	118
	Br	70601LBI30-DA	70601LBI60-DA								
	Ga	70605LBC30-DA	70605LBC60-DA	2x37W	2x4740	220-240V (1050mA)	3000	>90	2x41W	8482	103
Br	70606LBC30-DA	70606LBC60-DA									
Ga	70605LBI30-DA	70605LBI60-DA	2x37W	2x4970	220-240V (1050mA)	4000	>90	2x41W	8893	108	
Br	70606LBI30-DA	70606LBI60-DA									
versione-version PLUS											
Ga	70615LBC30-DA	70615LBC60-DA	2x43W	2x5280	220-240V (1200mA)	3000	>90	2x47W	9020	96	
Br	70616LBC30-DA	70616LBC60-DA									
Ga	70615LBI30-DA	70615LBI60-DA	2x43W	2x5520	220-240V (1200mA)	4000	>90	2x47W	9346	99	
Br	70616LBI30-DA	70616LBI60-DA									

OP: A richiesta - On request: Led con temperatura di COLORE 2700K - Temperature Led COLOUR 2700K

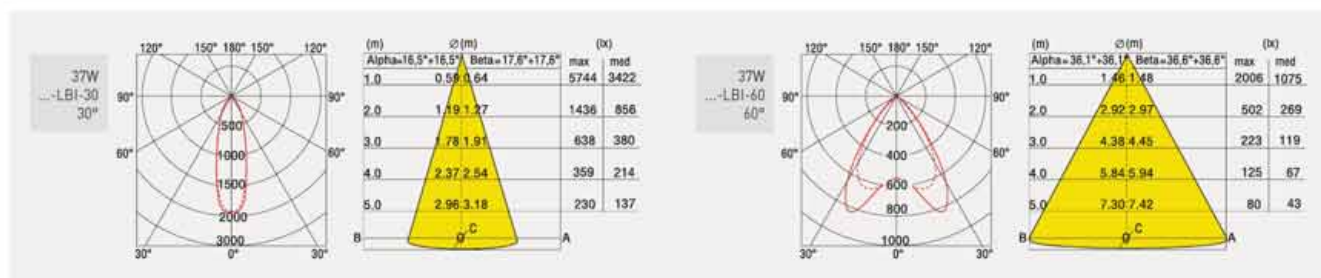

ALIMENTATORI-KIT RGB (se non in dotazione) da ordinare dalla sezione arancio - DRIVERS-RGB KITS (when not supplied) to be ordered from the section orange color



• LUCE CONCENTRANTE – SPOT LIGHTING

PERFORMANCE



BEND SLIM
135

NEW



BEND XS 2019
141



LUXOR
143



SIRIUS MCL
147

COMFORT



SHORT
149

NEW



SHORT ZOOM
153

NEW



STILO
155



VEGA BINARIO
161

• LUCE DIFFUSA – FLOODLIGHTING

PERFORMANCE



BIG BINARIO
163



SOLARIS MCL BINARIO
164



NEW

ROSS BINARIO
167

• MAGNET.G2 SYSTEM 48V



MAGNET.G2
BINARIO
170



MAGNET.G2
LINEARI
174



MAGNET.G2
SPOT
176



MAGNET.G2
DROP
177

• BINARI ELETTIFICATI – ELECTRIFIED TRACK



BINARIO
179

• PLAFONE – CEILING



BEND MICRO
189



BEND MINI
191





BEND MINI SLIM



- Corpo e vano ottico in pressofusione di alluminio verniciato.
 - Adattatore elettrico trifase con drivers incorporato.
 - Riflettore in policarbonato metallizzato a specchio.
 - Led durata utile: 50.000 (h) L80 B20.
 - Consistenza cromatica: 3 SDCM.
-
- Housing and optic tray made of powder coated die-cast aluminium.
 - Triphase electric adaptor with build-in driver.
 - Polycarbonate reflector mirrored metallized.
 - Led life: 50.000 (h) L80 B20.
 - Chromatic consistency: 3 SDCM.

	Kg 0,50	Br	Ne	LED	W	lm	V	K	CRI	SISTEMA-SYSTEM			
										W	lm	lm/W	
		67395-LBC-20	67395-LBC-40		12,4W	1580	220-240V (350mA)	3000	>80	14,4W	1390	97	(20°)
		67396-LBC-20	67396-LBC-40								1470	102	(40°)
		67395-LBN-20	67395-LBN-40		12,4W	1650	220-240V (350mA)	4000	>80	14,4W	1450	97	(20°)
		67396-LBN-20	67396-LBN-40								1335	107	(40°)

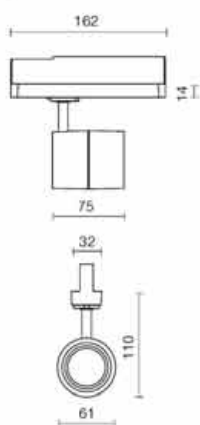

*In fase di approvazione - Under approval

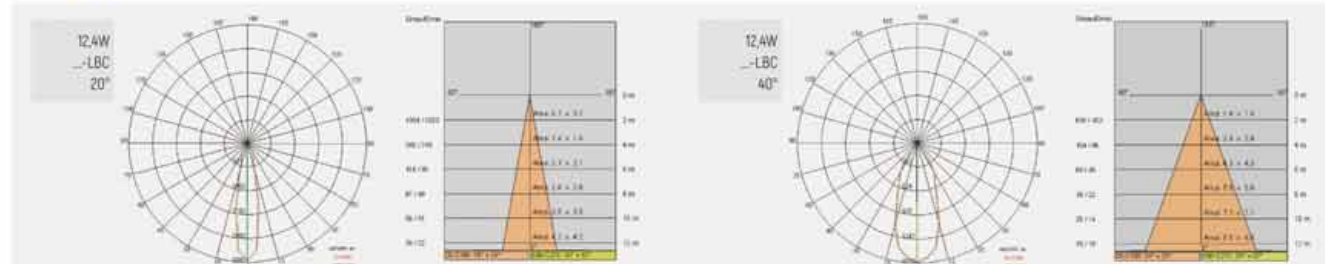

ALIMENTATORI-KIT RGB (se non in dotazione) da ordinare dalla sezione arancio - DRIVERS-RGB KITS (when not supplied) to be ordered from the section orange color

BEND SLIM XS

- Corpo e vano ottico in pressofusione di alluminio verniciato.
- Adattatore elettrico trifase con drivers.
- Vetro di protezione.
- Raffreddamento Led passivo.
- Riflettore in alluminio purissimo, metallizzato in alto vuoto.
- Led durata utile: 50.000 (h) L90 B20.
- Consistenza cromatica: 3 SDCM.
- Fattore di potenza: 0,97.
- Isolamento SELV.
- Armoniche corrente emesse: secondo EN 61000-3-2.
- Inrush current: 5A 50us
- Temperatura ambiente: -20 +50°C.

- Housing and optic tray made of powder coated die-cast aluminium..
- Triphase electric adaptor with driver.
- Protection glass.
- Passive heatsink.
- High purity aluminium reflector, high vacuum metallized.
- Led life: 50.000 (h) L90 B20.
- Chromatic consistency: 3 SDCM.
- Power factor: 0,97.
- SELV safety-insulation.
- Limits for harmonic current emissions as EN 61000-3-2.
- Inrush current: 5A 50us
- Working temperature: -20 +50°C.



				LED					SISTEMA-SYSTEM				
				W	lm	V	K	CR1	W	lm	lm		
	Br	67335-LBC-15	67335-LBC-25	67335-LBC-40	24W	3365	220-240V [700mA]	3000	>90	27W	2955	109	[15°]
	Ne	67336-LBC-15	67336-LBC-25	67336-LBC-40						27W	2790	103	[25°]
	Br	67335-LBN-15	67335-LBN-25	67335-LBN-40	24W	3570	220-240V [700mA]	4000	>90	27W	3136	116	[15°]
	Ne	67336-LBN-15	67336-LBN-25	67336-LBN-40						27W	2960	110	[25°]
versione-version PLUS													
	Br	67335P-LBC-15	67335P-LBC-25	67335P-LBC-40	31W	4170	220-240V [900mA]	3000	>90	35W	3663	105	[15°]
	Ne	67336P-LBC-15	67336P-LBC-25	67336P-LBC-40						35W	3466	99	[25°]
	Br	67335P-LBN-15	67335P-LBN-25	67335P-LBN-40	31W	4395	220-240V [900mA]	4000	>90	35W	3860	110	[15°]
	Ne	67336P-LBN-15	67336P-LBN-25	67336P-LBN-40						35W	3660	105	[25°]

DP. A richiesta - On request: Led con temperatura di colore 2700K - Temperature Led colour 2700K

ACC. Br **3014-BR** Alette direzionali - Directional flaps
Ne **3014-NE**

ACCESSORI GIÀ MONTATI - ALREADY ASSEMBLED ACCESSORIES

- 3079 Griglia alveolare - Alveolar grid
 - Br 3079-1 Schermo asimmetrico con vetro prismatico
 - Ne 3079-2 Asymmetrical screen with prismatic glass
-

*In fase di approvazione - Under approval

IP 20

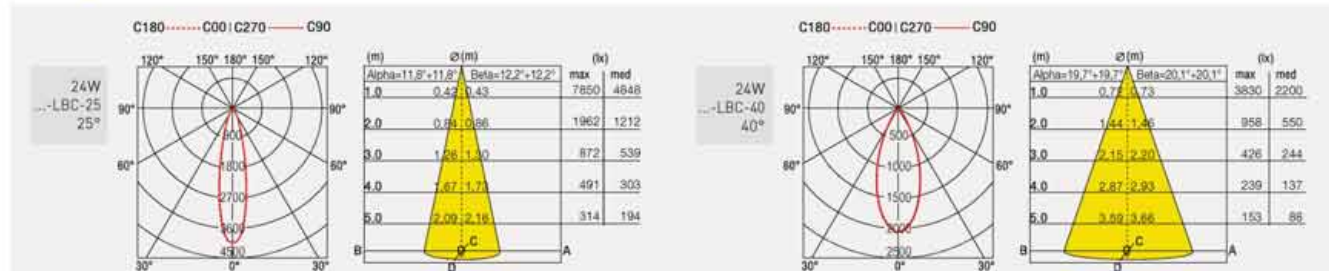

ALIMENTATORI-KIT RGB (se non in dotazione) da ordinare dalla sezione arancio - DRIVERS-RGB KITS (when not supplied) to be ordered from the section orange color



BEND SLIM M



- Corpo e vano ottico in pressofusione di alluminio verniciato.
 - Adattatore elettrico trifase con drivers.
 - Vetro di protezione.
 - Raffreddamento Led passivo.
 - Riflettore in alluminio purissimo, metallizzato in alto vuoto.
 - Led durata utile: 50.000 (h) L90 B20.
 - Consistenza cromatica: 3 SDCM.
 - Fattore di potenza: 0,97.
 - Isolamento SELV.
 - Armoniche corrente emesse: secondo EN 61000-3-2.
 - Inrush current: 5A 50us
 - Temperatura ambiente: -20 +50°C.
-
- Housing and optic tray made of powder coated die-cast aluminium.
 - Triphase electric adaptor with driver.
 - Protection glass.
 - Passive heatsink.
 - High purity aluminium reflector, high vacuum metallized.
 - Led life: 50.000 (h) L90 B20.
 - Chromatic consistency: 3 SDCM.
 - Power factor: 0,97.
 - SELV safety-insulation.
 - Limits for harmonic current emissions as EN 61000-3-2.
 - Inrush current: 5A 50us
 - Working temperature: -20 +50°C.

	Br	Ne	Gr	LED			SISTEMA-SYSTEM				
				W	lm	V	K	CRI	W	lm	lm/W
	67355-LBC-15	67355-LBC-30	67355-LBC-60	37W	4740	220-240V [1050mA]	3000	>90	4120	101	[15°]
	67356-LBC-15	67356-LBC-30	67356-LBC-60						4170	102	[30°]
	67357-LBC-15	67357-LBC-30	67357-LBC-60						4120	101	[60°]
	67355-LBN-15	67355-LBN-30	67355-LBN-60	37W	4970	220-240V [1050mA]	4000	>90	4320	106	[15°]
	67356-LBN-15	67356-LBN-30	67356-LBN-60						4370	107	[30°]
	67357-LBN-15	67357-LBN-30	67357-LBN-60						4320	106	[60°]

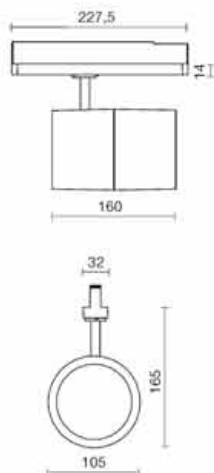

OP. A richiesta - On request: Led con temperatura di colore 2700K - Temperature Led colour 2700K

- ACC. Br **3031-BR**
 Ne **3031-NE** Alette direzionali - Directional flaps
 Gr **3031-GA**
- 3010** Griglia alveolare - Alveolar grid

*In fase di approvazione - Under approval

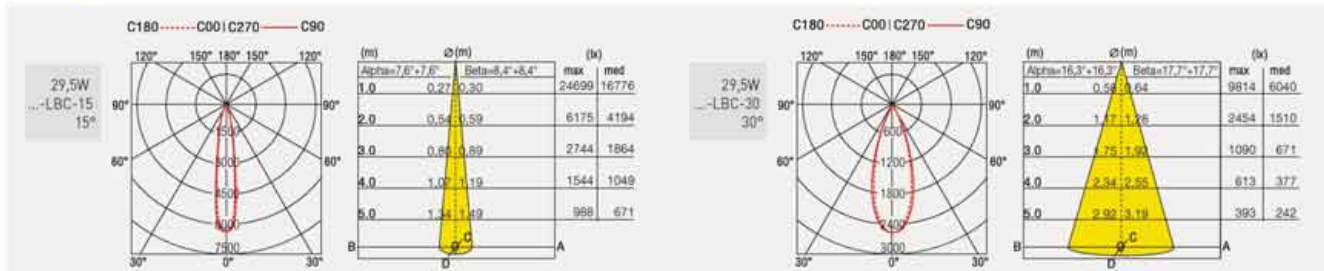

ALIMENTATORI-KIT RGB (se non in dotazione) da ordinare dalla sezione arancio - DRIVERS-RGB KITS (when not supplied) to be ordered from the section orange color



BEND SLIM XL



- Corpo e vano ottico in pressofusione di alluminio verniciato.
 - Adattatore elettrico trifase con drivers.
 - Vetro di protezione.
 - Raffreddamento Led passivo.
 - Riflettore in alluminio purissimo, metallizzato in alto vuoto.
 - Led durata utile: 50.000 (h) L90 B20.
 - Consistenza cromatica: 3 SDCM.
 - Fattore di potenza: 0,97.
 - Isolamento SELV.
 - Armoniche corrente emesse: secondo EN 61000-3-2.
 - Inrush current: 5A 50us
 - Temperatura ambiente: -20 +50°C.
-
- Housing and optic tray made of powder coated die-cast aluminium.
 - Triphase electric adaptor with driver.
 - Protection glass.
 - Passive heatsink.
 - High purity aluminium reflector, high vacuum metallized.
 - Led life: 50.000 (h) L90 B20.
 - Chromatic consistency: 3 SDCM.
 - Power factor: 0,97.
 - SELV safety-insulation.
 - Limits for harmonic current emissions as EN 61000-3-2.
 - Inrush current: 5A 50us
 - Working temperature: -20 +50°C.

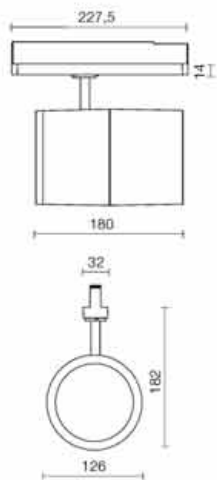

9kg
1.90

			LED					SISTEMA-SYSTEM			
			W	lm	V	K	CRI	W	lm	IP	
Br	67305K-LBC-25	67305K-LBC-60	37W	4740	220-240V [1050mA]	3000	+90	41W	4062	99	[25°]
Ne	67306K-LBC-25	67306K-LBC-60									[60°]
Br	67305K-LBN-25	67305K-LBN-60	37W	4070	220-240V [1050mA]	4000	+90	41W	4359	106	[25°]
Ne	67306K-LBN-25	67306K-LBN-60									[60°]

QP: A richiesta - On request: Versione con basetta tonda ø 100mm per plafone - Version with round base ø 100mm only ceiling
Led con temperatura di COLORE 2700K - Temperature LED COLOUR 2700K

*In fase di approvazione - Under approval

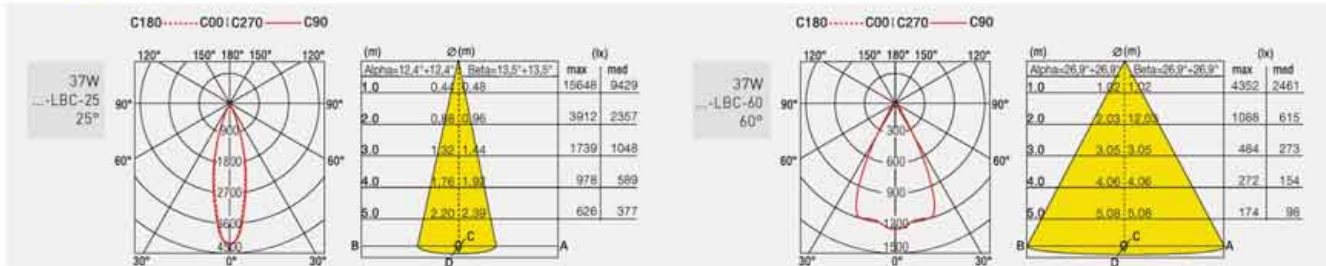

ALIMENTATORI-KIT RGB (se non in dotazione) da ordinare dalla sezione arancio - DRIVERS-RGB KITS (when not supplied) to be ordered from the section orange color

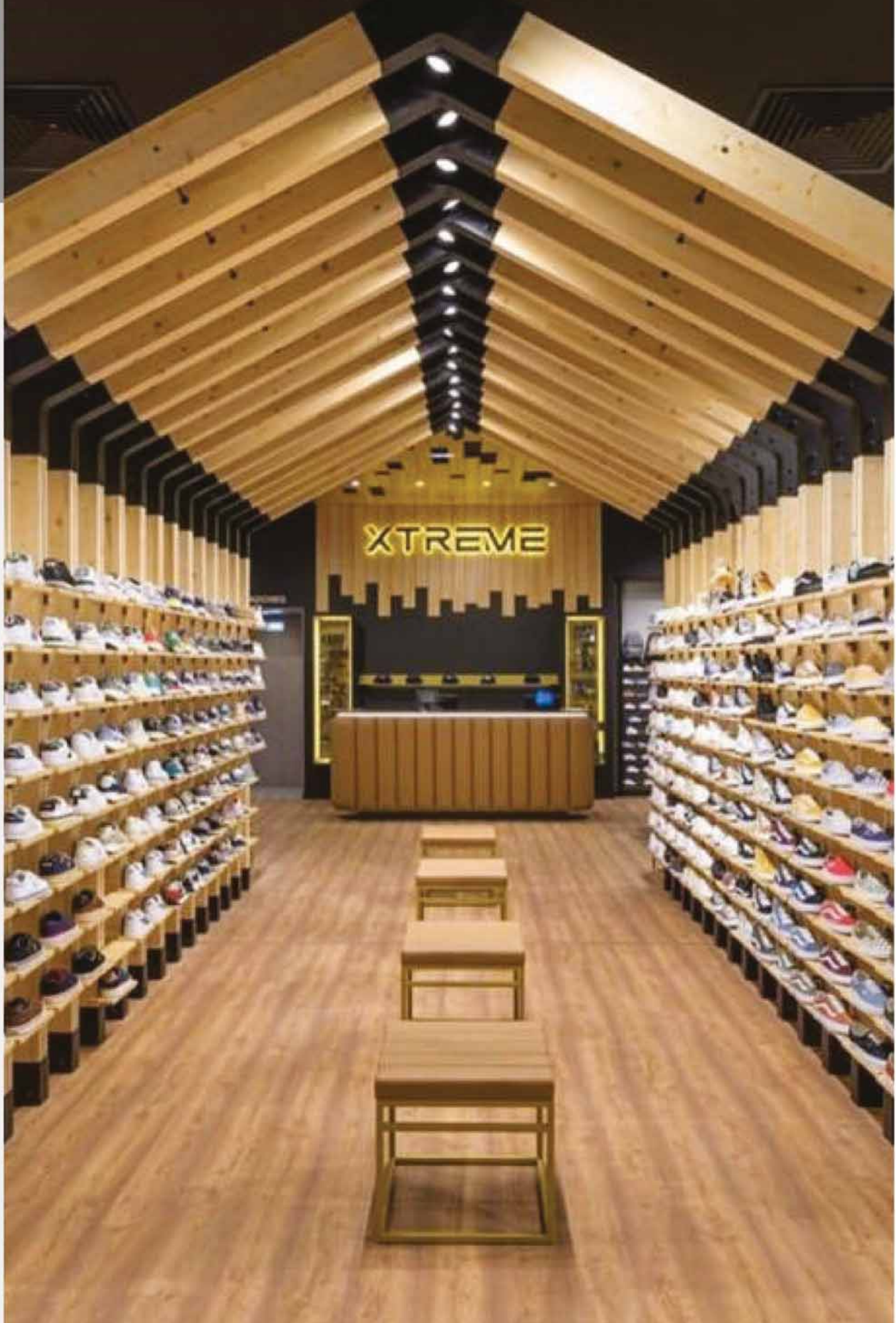



BEND XS 2019

- Corpo in pressofusione di alluminio verniciato.
- Verniciatura in polveri di poliestere.
- Adattatore elettrico trifase con driver integrato.
- Vetro di protezione.
- Riflettore in alluminio purissimo, metallizzato in alto vuoto.
- Led durata utile: 50.000 (h) L90 B20.
- Consistenza cromatica: 3 SDCM.

- Body made in painted die-cast aluminum.
- Polyester powder coating.
- Three-phase electric adapter with integrated driver.
- Protection glass.
- Pure aluminum reflector, high vacuum metallized.
- Led service life: 50,000 (h) L90 B20.
- Chromatic consistency: 3 SDCM.

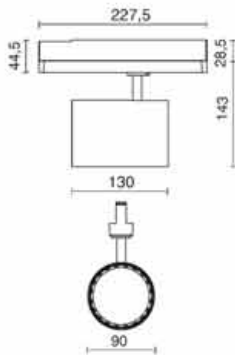

					LED					SISTEMA-SYSTEM			
					W	lm	V	K	CRI	W	lm	W	
Br	67308-LBC-15	67308-LBC-25	67308-LBC-40	67308-LBC-60	31W	3960	220-240V [900mA]	3000	>90	35W	3478	99	[15°]
Ne	67309-LBC-15	67309-LBC-25	67309-LBC-40	67309-LBC-60							3370	96	[25°]
Gr	67310-LBC-15	67310-LBC-25	67310-LBC-40	67310-LBC-60							2974	85	[40°]
Br	67308-LBN-15	67308-LBN-25	67308-LBN-40	67308-LBN-60	31W	4270	220-240V [900mA]	4000	>90	35W	3750	107	[15°]
Ne	67309-LBN-15	67309-LBN-25	67309-LBN-40	67309-LBN-60							3639	104	[25°]
Gr	67310-LBN-15	67310-LBN-25	67310-LBN-40	67310-LBN-60							3207	92	[40°]
											3353	96	[60°]

OP A richiesta - On request: disponibile - available



* In fase di approvazione - Under approval

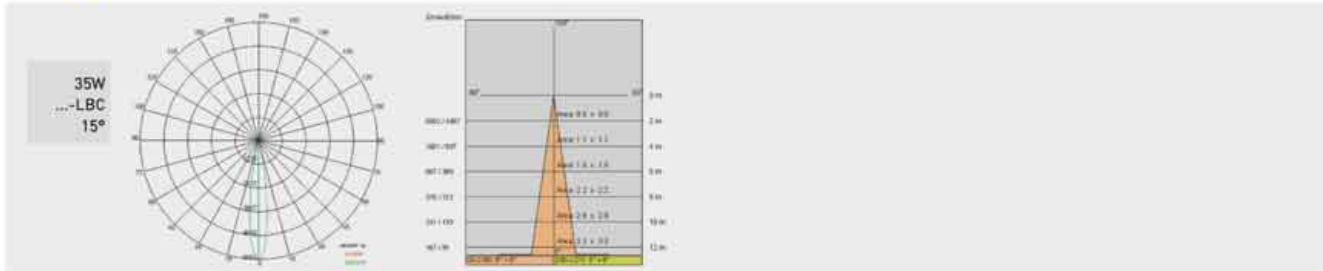
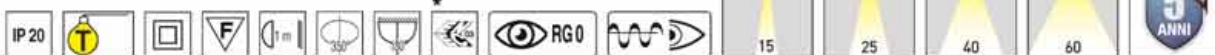

ALIMENTATORI-KIT RGB (se non in dotazione) da ordinare dalla sezione arancio - DRIVERS-RGB KITS (when not supplied) to be ordered from the section orange color



*In fase di approvazione - Under approval

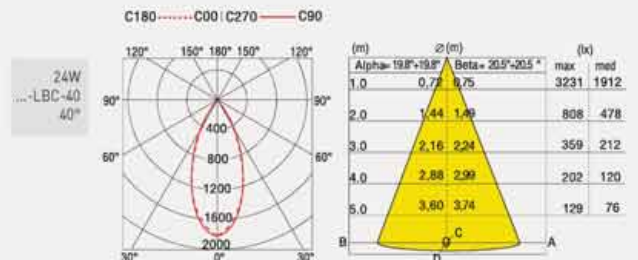
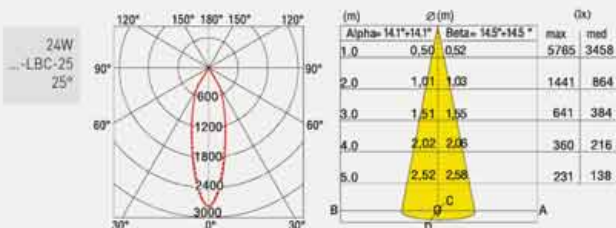
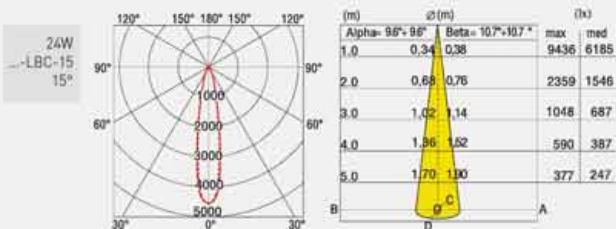

ALIMENTATORI-KIT RGB (se non in dotazione) da ordinare dalla sezione arancio - DRIVERS-RGB KITS (when not supplied) to be ordered from the section orange color



- Vano ottico e contenitore driver in pressofusione di alluminio verniciato in polveri.
- Adattatore elettrico trifase.
- Parabola sfaccettata in alluminio purissimo.
- Raffreddamento Led passivo con dissipatore.
- Vetro di protezione.
- Led durata utile: 50.000 (h) L90 B50.

- Optic tray and driver made of powder coated die-cast aluminium.
- Triphase electric adaptor.
- Reflector in pure aluminium.
- Passive heatsink.
- Protection glass.
- Led life: 50.000 (h) L90 B50.



				LED					SISTEMA-SYSTEM			
				W	lm	V	K	CRI	W	lm	lp	
ORIZZONTALE PER BINARIO - HORIZONTAL FOR TRACK												
	Br	6770-LBC-15	6770-LBC-25	6770-LBC-40	31W	4170	220-240V [900mA]	3000	>90	35W	3761	107 [15°]
	Ne	6771-LBC-15	6771-LBC-25	6771-LBC-40						3822	109 [25°]	
	Ga	6772-LBC-15	6772-LBC-25	6772-LBC-40						3761	107 [40°]	
	Br	6770-LBI-15	6770-LBI-25	6770-LBI-40	31W	4395	220-240V [900mA]	4000	>90	35W	3964	113 [15°]
	Ne	6771-LBI-15	6771-LBI-25	6771-LBI-40						4029	115 [25°]	
	Ga	6772-LBI-15	6772-LBI-25	6772-LBI-40						3964	117 [40°]	
	Br	6770LBC15-DA	6770LBC25-DA	6770LBC40-DA	31W	4170	220-240V [900mA]	3000	>90	35W	3761	107 [15°]
	Ne	6771LBC15-DA	6771LBC25-DA	6771LBC40-DA						3822	109 [25°]	
	Ga	6772LBC15-DA	6772LBC25-DA	6772LBC40-DA						3761	107 [40°]	
	Br	6770LBI15-DA	6770LBI25-DA	6770LBI40-DA	31W	4395	220-240V [900mA]	4000	>90	35W	3964	113 [15°]
	Ne	6771LBI15-DA	6771LBI25-DA	6771LBI40-DA						4029	115 [25°]	
	Ga	6772LBI15-DA	6772LBI25-DA	6772LBI40-DA						3964	113 [40°]	
VERTICALE PER BINARIO - VERTICAL FOR TRACK												
	Br	6773-LBC-15	6773-LBC-25	6773-LBC-40	31W	4170	220-240V [900mA]	3000	>90	35W	3761	107 [15°]
	Ne	6774-LBC-15	6774-LBC-25	6774-LBC-40						3822	109 [25°]	
	Ga	6775-LBC-15	6775-LBC-25	6775-LBC-40						3761	107 [40°]	
	Br	6773-LBI-15	6773-LBI-25	6773-LBI-40	31W	4395	220-240V [900mA]	4000	>90	35W	3964	113 [15°]
	Ne	6774-LBI-15	6774-LBI-25	6774-LBI-40						4029	115 [25°]	
	Ga	6775-LBI-15	6775-LBI-25	6775-LBI-40						3761	113 [40°]	
	Br	6773LBC15-DA	6773LBC25-DA	6773LBC40-DA	31W	4170	220-240V [900mA]	3000	>90	35W	3761	107 [15°]
	Ne	6774LBC15-DA	6774LBC25-DA	6774LBC40-DA						3822	109 [25°]	
	Ga	6775LBC15-DA	6775LBC25-DA	6775LBC40-DA						3761	107 [40°]	
	Br	6773LBI15-DA	6773LBI25-DA	6773LBI40-DA	31W	4395	220-240V [900mA]	4000	>90	35W	3964	113 [15°]
	Ne	6774LBI15-DA	6774LBI25-DA	6774LBI40-DA						4029	115 [25°]	
	Ga	6775LBI15-DA	6775LBI25-DA	6775LBI40-DA						3964	113 [40°]	

OP. A richiesta - On request: Versione con basetta tonda ø 100mm per plafone - Version with round base ø 100mm only ceiling
Vetro sabbato - Frosted glass
Led con temperatura di COLORE 2700K - Temperature LED COLOUR 2700K

LUXOR XL

- Vano ottico e contenitore driver in pressofusione di alluminio verniciato in polveri.
- Adattatore elettrico trifase.
- Parabola sfaccettata in alluminio purissimo.
- Raffreddamento Led passivo con dissipatore.
- Vetro di protezione.
- Led durata utile: 50.000 (h) L90 B50.

- Optic tray and driver made of powder coated die-cast aluminium.
- Triphase electric adaptor.
- Faceted in pure aluminium.
- Passive heatsink.
- Protection glass.
- Led life: 50.000 (h) L90 B50.



	30	60	LED					SISTEMA-SYSTEM			
			W	lm	V	K	CRI	W	lm	lm	
ORIZZONTALE PER BINARIO - HORIZONTAL FOR TRACK											
Br	67776-LBC-30	67776-LBC-60									
Ne	67777-LBC-30	67777-LBC-60	37W	4740	220-240V [1050mA]	3000	>90	41W	4304	105	[30°]
Ga	67778-LBC-30	67778-LBC-60						4318	105		[60°]
Br	67776-LBI-30	67776-LBI-60									
Ne	67777-LBI-30	67777-LBI-60	37W	4970	220-240V [1050mA]	4000	>90	41W	4513	110	[30°]
Ga	67778-LBI-30	67778-LBI-60						4528	110		[60°]
Versione-version PLUS											
Br	67805-LBC-30	67805-LBC-60									
Ne	67806-LBC-30	67806-LBC-60	43W	5280	220-240V [1200mA]	3000	>90	47W	4794	102	[30°]
Ga	67807-LBC-30	67807-LBC-60						4810	102		[60°]
Br	67805-LBI-30	67805-LBI-60									
Ne	67806-LBI-30	67806-LBI-60	43W	5520	220-240V [1200mA]	4000	>90	47W	5012	107	[30°]
Ga	67807-LBI-30	67807-LBI-60						5029	107		[60°]
DALI DIM-DALI/PUSH											
Br	67776LBC30-DA	67776LBC60-DA									
Ne	67777LBC30-DA	67777LBC60-DA	37W	4740	220-240V [1050mA]	3000	>90	41W	4304	105	[30°]
Ga	67778LBC30-DA	67778LBC60-DA						4318	105		[60°]
Br	67776LBI30-DA	67776LBI60-DA									
Ne	67777LBI30-DA	67777LBI60-DA	37W	4970	220-240V [1050mA]	4000	>90	41W	4513	110	[30°]
Ga	67778LBI30-DA	67778LBI60-DA						4528	110		[60°]
Versione-version PLUS											
Br	67805LBC30-DA	67805LBC60-DA									
Ne	67806LBC30-DA	67806LBC60-DA	43W	5280	220-240V [1200mA]	3000	>90	47W	4794	102	[30°]
Ga	67807LBC30-DA	67807LBC60-DA						4810	102		[60°]
Br	67805LBI30-DA	67805LBI60-DA									
Ne	67806LBI30-DA	67806LBI60-DA	43W	5520	220-240V [1200mA]	4000	>90	47W	5012	107	[30°]
Ga	67807LBI30-DA	67807LBI60-DA						5029	107		[60°]

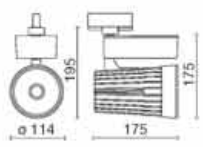

Reg. 215

IP 20, T, F, 1m, 30°, 60°, RG0, 5 ANNI, inside

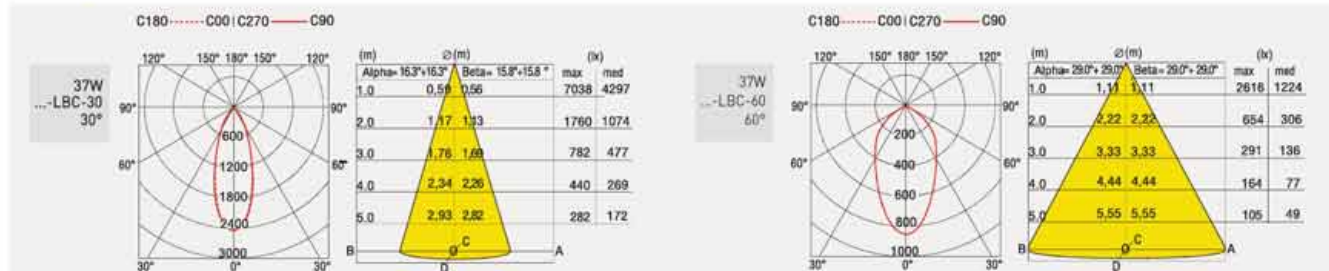

ALIMENTATORI-KIT RGB (se non in dotazione) da ordinare dalla sezione arancio - DRIVERS-RGB KITS (when not supplied) to be ordered from the section orange color



	LED					SISTEMA-SYSTEM					
	W	lm	V	K	CRI	W	lm	lm	W		
	VERTICALE PER BINARIO - VERTICAL FOR TRACK										
	Br	67800-LBC-30	67800-LBC-60								
	Ne	67801-LBC-30	67801-LBC-60	37W	4740	220-240V [1050mA]	3000	>90	41W	4304	105 [30°] 105 [60°]
Ga	67802-LBC-30	67802-LBC-60									
versione-version PLUS											
Br	67808-LBC-30	67808-LBC-60									
Ne	67809-LBC-30	67809-LBC-60	43W	5280	220-240V [1200mA]	3000	>90	47W	4794	102 [30°] 102 [60°]	
Ga	67810-LBC-30	67810-LBC-60									
Br	67808-LBI-30	67808-LBI-60									
Ne	67809-LBI-30	67809-LBI-60	43W	5520	220-240V [1200mA]	4000	>90	47W	5012	107 [30°] 107 [60°]	
Ga	67810-LBI-30	67810-LBI-60									
DIM-DALI/PUSH											
	Br	67800LBC30-DA	67800LBC60-DA								
	Ne	67801LBC30-DA	67801LBC60-DA	37W	4740	220-240V [1050mA]	3000	>90	41W	4304	105 [30°] 105 [60°]
	Ga	67802LBC30-DA	67802LBC60-DA								
Br	67800LBI30-DA	67800LBI60-DA									
Ne	67801LBI30-DA	67801LBI60-DA	37W	4970	220-240V [1050mA]	4000	>90	41W	4513	110 [30°] 110 [60°]	
Ga	67802LBI30-DA	67802LBI60-DA									
versione-version PLUS											
Br	67808LBC30-DA	67808LBC60-DA									
Ne	67809LBC30-DA	67809LBC60-DA	43W	5280	220-240V [1200mA]	3000	>90	47W	4794	102 [30°] 102 [60°]	
Ga	67810LBC30-DA	67810LBC60-DA									
Br	67808LBI30-DA	67808LBI60-DA									
Ne	67809LBI30-DA	67809LBI60-DA	43W	5520	220-240V [1200mA]	4000	>90	47W	5012	107 [30°] 107 [60°]	
Ga	67810LBI30-DA	67810LBI60-DA									

OP A richiesta - On request: Versione verticale con basetta tonda ø 100mm per plafone - Vertical version with round base ø 100mm only ceiling
Vetro sabbiato - Frosted glass
Led con temperatura di COLORE 2700K - Temperature LED COLOUR 2700K



adidas[®]



SIRIUS MCL

- Corpo in estruso di alluminio.
- Staffa in acciaio verniciato.
- Riflettori in alluminio.
- Vetro di protezione trasparente.
- Verniciatura in polveri epossidiche.
- Led durata utile: 50.000 (h) L90 B50.

- Body made of extruded aluminium.
- Coated steel support.
- Aluminium reflector.
- Transparent protection glass.
- Epoxy powder coated.
- Led life: 50.000 (h) L90 B50.



	29	40	50	LED					SISTEMA-SYSTEM					
				W	lm	V	K	CRI	W	lm	lm/W			
Br 67191-LBC	67191-LBC-40	67191-LBC-60												
Ne 67192-LBC	67192-LBC-40	67192-LBC-60		37W	4740	220-240V (1050mA)	3000	>80	41W	4082	100	[20°]	[40°]	[60°]
Ga 67193-LBC	67193-LBC-40	67193-LBC-60							4598	112				
Br 67191-LBN	67191-LBN-40	67191-LBN-60												
Ne 67192-LBN	67192-LBN-40	67192-LBN-60		37W	4970	220-240V (1050mA)	4000	>90	41W	4257	104	[20°]	[40°]	[60°]
Ga 67193-LBN	67193-LBN-40	67193-LBN-60							4821	117				
versione-version PLUS														
Br 67194-LBC	67194-LBC-40	67194-LBC-60												
Ne 67195-LBC	67195-LBC-40	67195-LBC-60		43W	5280	220-240V (1200mA)	3000	>80	47W	4612	98	[20°]	[40°]	[60°]
Ga 67196-LBC	67196-LBC-40	67196-LBC-60							5122	109				
Br 67194-LBN	67194-LBN-40	67194-LBN-60												
Ne 67195-LBN	67195-LBN-40	67195-LBN-60		43W	5520	220-240V (1200mA)	4000	>90	47W	4712	100	[20°]	[40°]	[60°]
Ga 67196-LBN	67196-LBN-40	67196-LBN-60							5354	114				
DALI DIM-DALI/PUSH														
Br 67191LBC-DA	67191LBC40-DA	67191LBC60-DA												
Ne 67192LBC-DA	67192LBC40-DA	67192LBC60-DA		37W	4740	220-240V (1050mA)	3000	>80	41W	4415	105	[20°]	[40°]	[60°]
Ga 67193LBC-DA	67193LBC40-DA	67193LBC60-DA							4598	112				
Br 67191LBN-DA	67191LBN40-DA	67191LBN60-DA												
Ne 67192LBN-DA	67192LBN40-DA	67192LBN60-DA		37W	4970	220-240V (1050mA)	4000	>90	41W	4755	116	[20°]	[40°]	[60°]
Ga 67193LBN-DA	67193LBN40-DA	67193LBN60-DA							4821	117				
versione-version PLUS														
Br 67194LBC-DA	67194LBC40-DA	67194LBC60-DA												
Ne 67195LBC-DA	67195LBC40-DA	67195LBC60-DA		43W	5280	220-240V (1200mA)	3000	>90	47W	5280	112	[20°]	[40°]	[60°]
Ga 67196LBC-DA	67196LBC40-DA	67196LBC60-DA							5122	109				
Br 67194LBN-DA	67194LBN40-DA	67194LBN60-DA												
Ne 67195LBN-DA	67195LBN40-DA	67195LBN60-DA		43W	5520	220-240V (1200mA)	4000	>90	47W	5520	117	[20°]	[40°]	[60°]
Ga 67196LBN-DA	67196LBN40-DA	67196LBN60-DA							5354	114				

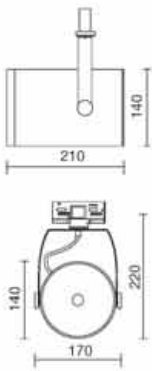

2,80 Kg

OP. A richiesta - On request: Led con temperatura di COLORE 2700K - Temperature LED COLOUR 2700K
Versione con basetta tonda ø 100mm per plafone - Version with round base ø 100mm only ceiling

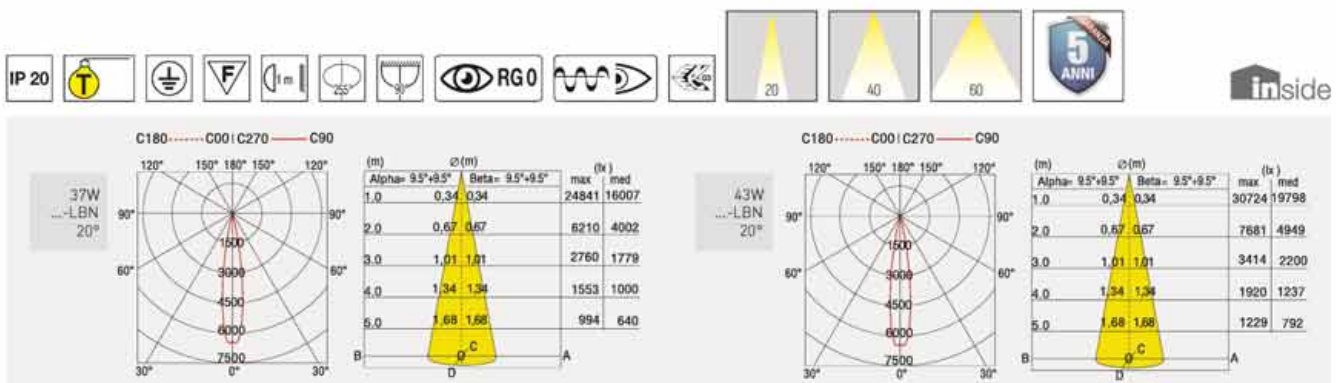

ALIMENTATORI-KIT RGB (se non in dotazione) da ordinare dalla sezione arancio - DRIVERS-RGB KITS (when not supplied) to be ordered from the section orange color





SHORT XS

- Corpo in pressofusione di alluminio verniciato.
- Adattatore elettrico trifase con driver 850 mA.
- Lente in PMMA.
- Raffreddamento Led passivo.
- Led durata utile: 50.000 (h) L90 B20.
- Consistenza cromatica: 3 SDCM.

- Body made of die-cast aluminium powder coated.
- Triphase electric adaptor with driver.
- Lenses in PMMA.
- Passive heatsink.
- Led life: 50.000 (h) L90 B20.
- Chromatic consistency: 3 SDCM.



	12	25	40	LED					SISTEMA-SYSTEM			
				W	lm	V	K	CRI	W	lm	lm/W	
Br 67325-LBC12AG	67325-LBC25AG	67325-LBC40AG	29,5W	3970	220-240V (1050mA)	3000	>90	33,5W	3058	91	(12°)	
Ne 67326-LBC12AG	67326-LBC25AG	67326-LBC40AG							2840	85	(24°)	
									2860	83	(40°)	
Br 67325-LBN12AG	67325-LBN25AG	67325-LBN40AG	29,5W	4195	220-240V (1050mA)	4000	>90	33,5W	3230	96	(12°)	
Ne 67326-LBN12AG	67326-LBN25AG	67326-LBN40AG							3020	90	(24°)	
									2900	87	(40°)	

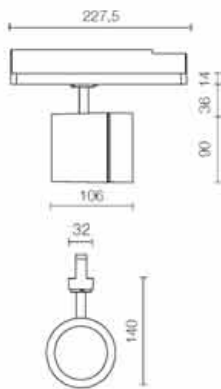

OP. *A richiesta - On request: apertura fascio - light beam
 A richiesta - On request: disponibile - available



ACC. Br 3014-BR Alette direzionali - Directional flaps
 Ne 3014-NE

*In fase di approvazione - Under approval

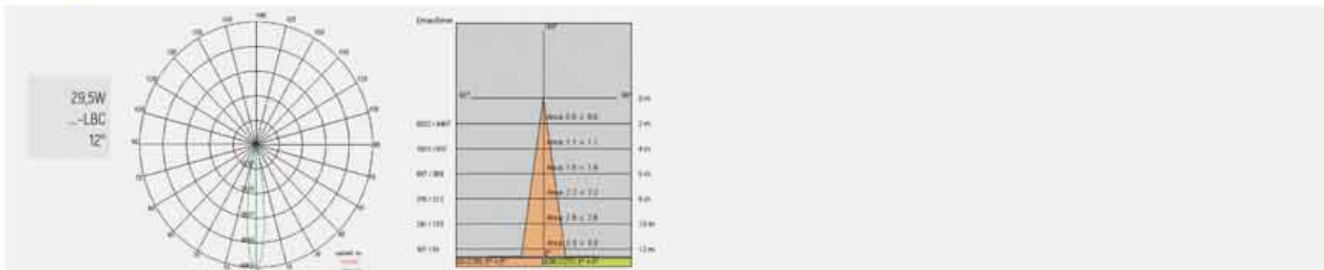

ALIMENTATORI-KIT RGB (se non in dotazione) da ordinare dalla sezione arancio - DRIVERS-RGB KITS (when not supplied) to be ordered from the section orange color



SHORT M



- Corpo in pressofusione di alluminio verniciato.
 - Box e coperchio in acciaio verniciato
 - Alimentatore elettronico.
 - Adattatore elettrico trifase
 - Lente in PMMA.
 - Raffreddamento Led passivo.
 - Led durata utile: 50.000 (h) L90 B20.
 - Consistenza cromatica: 3 SDCM.
- Body made of die-cast aluminium powder coated.
 - Painted steel box and cap.
 - Electronic driver.
 - Triphase electric adaptor.
 - Lenses in PMMA.
 - Passive heatsink.
 - Led life: 50.000 (h) L90 B20.
 - Chromatic consistency: 3 SDCM.



	12	24	40	LED					SISTEMA-SYSTEM			
				W	(lm)	V	K	CRI	W	(lm)	(W)	
Br 67397-LBC12AG	67397-LBC25AG	67397-LBC40AG		37W	4740	220-240V	3000	>90	41W	3650	89	(12")
Ne 67398-LBC12AG	67398-LBC25AG	67398-LBC40AG				[1050mA]				3416	83	(24")
										3250	79	(40")
Br 67397-LBN12AG	67397-LBN25AG	67397-LBN40AG		37W	4970	220-240V	4000	>90	41W	3828	93	(12")
Ne 67398-LBN12AG	67398-LBN25AG	67398-LBN40AG				[1050mA]				3581	87	(24")
										3405	83	(40")

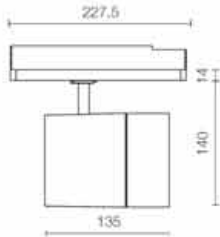

1,70 Kg



OP. *A richiesta - On request: apertura fascio - light beam
A richiesta - On request: disponibile - available



ACC. Br 3031-BR Alette direzionali - Directional flaps
Ne 3031-NE

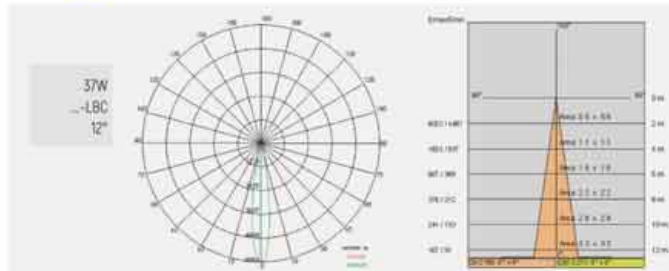

ALIMENTATORI-KIT RGB (se non in dotazione) da ordinare dalla sezione arancio - DRIVERS-RGB KITS (when not supplied) to be ordered from the section orange color





SHORT ZOOM



- Corpo in pressofusione di alluminio.
- Verniciatura in polveri di poliestere.
- Adattatore elettrico trifase con driver integrato per montaggio a binario.
- Lente in PMMA.
- Fascio regolabile da 10° a 60°.
- Scala graduata sul corpo ottico.
- Led durata utile: 50.000 (h) L90 B20.
- Consistenza cromatica: 3 SDCM.

- Die-cast aluminum body.
- Polyester powder coating.
- Three-phase electric adapter with integrated driver for track mounting.
- PMMA lens.
- Optics adjustable from 10 to 60 degrees
- Graduated scale on optical body
- Available colors Black and white
- Led useful life: 50,000 (h) L90 B20.
- Chromatic consistency: 3 SDCM.

	Br 67405-LBC	10° ± 60°	35W	3700	220-240V [900mA]	3000	CRI>90
	Ne 67406-LBC						
	Br 67405-LBN	10° ± 60°	35W	3800	220-240V [900mA]	4000	CRI>90
	Ne 67406-LBN						

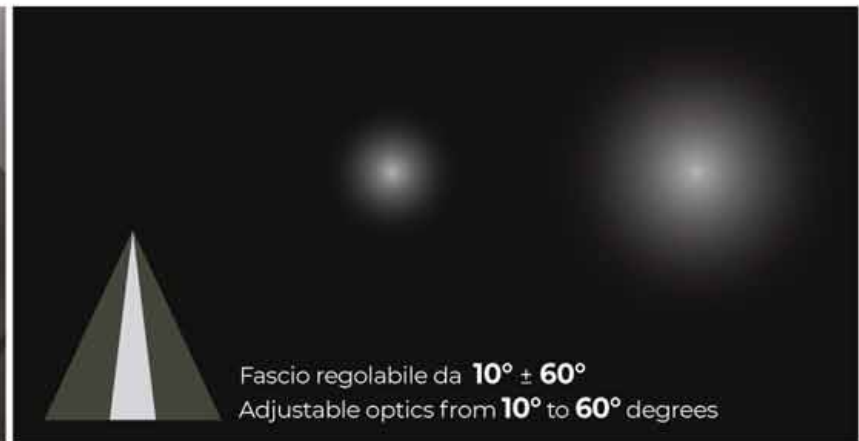

ALIMENTATORI-KIT RGB (se non in dotazione) da ordinare dalla sezione arancio - DRIVERS-RGB KITS (when not supplied) to be ordered from the section orange color





STILO

STILO può essere personalizzato con una serie di accessori per il raggiungimento del miglior comfort visivo.

STILO can be customized with a series of accessories to achieve the best visual comfort.

versione per BINARIO CON ADATTATORE SLIM
version for TRACK WITH SLIM ADAPTER

DRIVER INTEGRATO NELL'ATTACCO A BINARIO
DRIVER INTEGRATED IN THE RAIL ATTACK

versione per BINARIO SITRACK TRIFASE 230V
version for SITRACK TRIPHASE 230V TRACK

DRIVER INTEGRATO NEL CORPO DELL'APPARECCHIO
DRIVER INTEGRATED IN THE BODY OF THE FITTING

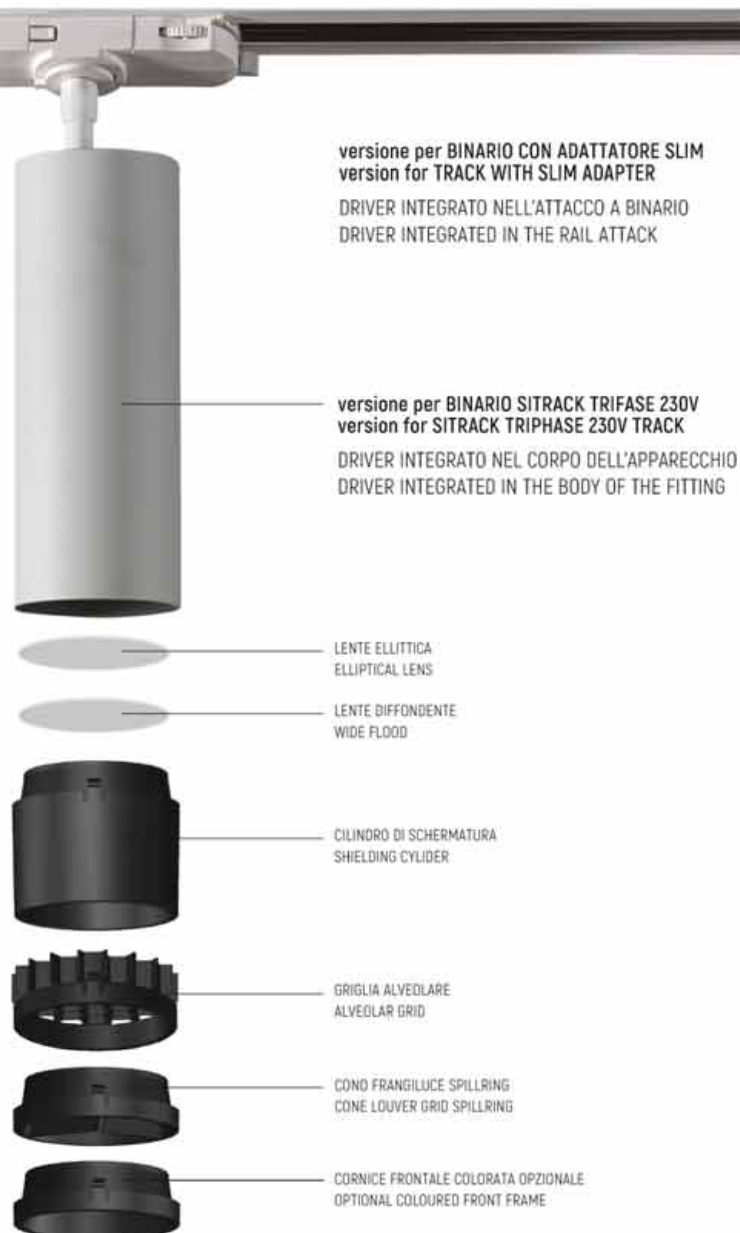



- Corpo in alluminio.
- Verniciatura per interni in polveri di poliestere.
- Lenti/riflettori in materiale ottico.
- Led durata utile: 50.000 (h) L80 B20.
- Consistenza cromatica: 3 SDCM.



- Aluminum body.
- Polyester powder coating for interiors.
- Lenses/reflectors in optical material.
- Led life: 50.000 (h) L80 B20.
- Chromatic consistency: 3 SDCM.

STILO Ø28

VERSIONE BINARIO MAGNETICO - MAGNETIC TRACK VERSION

	ON-OFF	LED	SISTEMA-SYSTEM								
			W	lm	lm/W						
	Br 67825-LBC-8	67825-LBC-30	4,5W	540	48Vdc [350mA]	3000	>80	5,5W	485	88	
	Ne 67826-LBC-8	67826-LBC-30									
	Gr 67827-LBC-8	67827-LBC-30									
		Br 67825-LBN-8	67825-LBN-30	4,5W	600	48Vdc [350mA]	4000	>80	5,5W	540	98
		Ne 67826-LBN-8	67826-LBN-30								
		Gr 67827-LBN-8	67827-LBN-30								
		Br 67825LBC8-DA	67825LBC30-DA	4,5W	540	48Vdc [350mA]	3000	>80	5,5W	485	88
		Ne 67826LBC8-DA	67826LBC30-DA								
		Gr 67827LBC8-DA	67827LBC30-DA								
		Br 67825LBN8-DA	67825LBN30-DA	4,5W	600	48Vdc [350mA]	4000	>80	5,5W	540	98
		Ne 67826LBN8-DA	67826LBN30-DA								
		Gr 67827LBN8-DA	67827LBN30-DA								

OP: A richiesta - On request: code.../FS - Versione corpo con palpebra inclinata
Body with inclined eyelid version



ALIMENTATORI-KIT RGB (se non in dotazione) da ordinare dalla sezione arancio - DRIVERS-RGB KITS (when not supplied) to be ordered from the section orange color





OP.	A richiesta - On request.	Cornice frontale - Front ring	
		Br 3125-1 Ne 3125-2 Oro 3125-3 Silver 3125-4 3125-5 Colore a richiesta - on request colour	
	code.../FS	Versione corpo con palpebra inclinata Body with inclined eyelid version	
	code.../CA	Versione con driver CASAMBI, solo per binario SITRACK With driver CASAMBI version, only SITRACK	

ACC.	Br 3112	Cilindro di schermatura - Shielding cylinder	
	Ne 3113		
	Ne 3116	Griglia alveolare - Alveolar grid	
	Ne 3118	Cono frangiluce Spillring - Cone louver grid Spillring	
	3120	Lente Ellittica - Elliptical lens	
	3122	Lente diffondente - Wide flood	







- Corpo in alluminio.
- Verniciatura per interni in polveri di poliestere.
- Lenti/riflettori in materiale ottico.
- Led durata utile: 50.000 (h) L80 B20.
- Consistenza cromatica: 3 SDCM.

- Aluminum body.
- Polyester powder coating for interiors.
- Lenses/reflectors in optical material.
- Led life: 50.000 (h) L80 B20.
- Chromatic consistency: 3 SDCM.







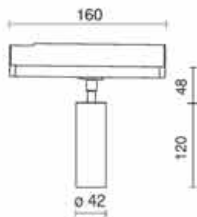

STILO Ø 42

VERSIONE BINARIO SITRACK CON ADATTATORE SLIM - VERSION FOR TRACK SITRACK WITH SLIM ADAPTER

	LED			SISTEMA-SYSTEM						
	W	lm	V	K	CRI	W	lm	lm/W		
  										
ON-OFF										
Br 67830-LBC-15	67830-LBC-24	67830-LBC-36								
Ne 67831-LBC-15	67831-LBC-24	67831-LBC-36	12,4W	1340	220-240V (350mA)	3000	>90	14,4W	1105	77
Gr 67832-LBC-15	67832-LBC-24	67832-LBC-36								
										
Br 67830-LBN-15	67830-LBN-24	67830-LBN-36								
Ne 67831-LBN-15	67831-LBN-24	67831-LBN-36	12,4W	1420	220-240V (350mA)	4000	>90	14,4W	1175	82
Gr 67832-LBN-15	67832-LBN-24	67832-LBN-36								



VERSIONE BINARIO MAGNETICO - MAGNETIC TRACK VERSION

	LED			SISTEMA-SYSTEM						
	W	lm	V	K	CRI	W	lm	lm/W		
  										
ON-OFF										
Br 67835-LBC-15	67835-LBC-24	67835-LBC-36								
Ne 67836-LBC-15	67836-LBC-24	67836-LBC-36	12,4W	1340	48Vdc (350mA)	3000	>90	14,4W	1105	77
Gr 67837-LBC-15	67837-LBC-24	67837-LBC-36								
										
Br 67835-LBN-15	67835-LBN-24	67835-LBN-36								
Ne 67836-LBN-15	67836-LBN-24	67836-LBN-36	12,4W	1420	48Vdc (350mA)	4000	>90	14,4W	1175	82
Gr 67837-LBN-15	67837-LBN-24	67837-LBN-36								
										
DALI DIM-DALI/PUSH										
Br 67835LBC15-DA	67835LBC24-DA	67835LBC36-DA								
Ne 67836LBC15-DA	67836LBC24-DA	67836LBC36-DA	12,4W	1340	48Vdc (350mA)	3000	>90	14,4W	1105	77
Gr 67837LBC15-DA	67837LBC24-DA	67837LBC36-DA								
										
Br 67835LBN15-DA	67835LBN24-DA	67835LBN36-DA								
Ne 67836LBN15-DA	67836LBN24-DA	67836LBN36-DA	12,4W	1420	48Vdc (350mA)	4000	>90	14,4W	1175	82
Gr 67837LBN15-DA	67837LBN24-DA	67837LBN36-DA								

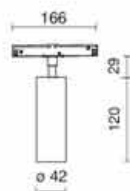
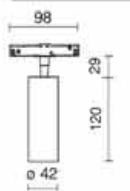

ALIMENTATORI-KIT RGB (se non in dotazione) da ordinare dalla sezione arancio - DRIVERS-RGB KITS (when not supplied) to be ordered from the section orange color

STILO

- Corpo in alluminio.
- Verniciatura per interni in polveri di poliestere.
- Lenti/riflettori in materiale ottico.
- Led durata utile: 50.000 (h) L80 B20.
- Consistenza cromatica: 3 SDCM.

- Aluminum body.
- Polyester powder coating for interiors.
- Lenses/reflectors in optical material.
- Led life: 50.000 (h) L80 B20.
- Chromatic consistency: 3 SDCM.



STILO Ø 60

VERSIONE PER BINARIO SITRACK CON ADATTATORE SLIM - VERSION FOR TRACK SITRACK WITH SLIM ADAPTER

Driver integrato nell'attacco a binario - Driver integrated in the rail attack

						LED					SISTEMA-SYSTEM		
						W	lm	V	K	CRI	W	lm	lm/W
ON-OFF													
Br	67840-LBC-6	67840-LBC-19	67840-LBC-27	67840-LBC-38	67840-LBC-56	18,5W	1950	220-240V [500mA]	3000	>90	22,5W	1755	78
Ne	67841-LBC-6	67841-LBC-19	67841-LBC-27	67841-LBC-38	67841-LBC-56								
Gr	67842-LBC-6	67842-LBC-19	67842-LBC-27	67842-LBC-38	67842-LBC-56								
Br	67840-LBN-6	67840-LBN-19	67840-LBN-27	67840-LBN-38	67840-LBN-56	18,5W	2085	220-240V [500mA]	4000	>90	22,5W	1875	83
Ne	67841-LBN-6	67841-LBN-19	67841-LBN-27	67841-LBN-38	67841-LBN-56								
Gr	67842-LBN-6	67842-LBN-19	67842-LBN-27	67842-LBN-38	67842-LBN-56								

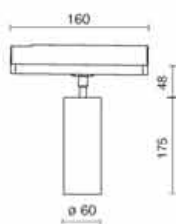

VERSIONE PER BINARIO SITRACK TRIFASE 230V - VERSION FOR SITRACK TRIPHASE 230V TRACK

Driver integrato nel corpo dell'apparecchio - Driver integrated in the body of the fitting

						LED					SISTEMA-SYSTEM		
						W	lm	V	K	CRI	W	lm	lm/W
ON-OFF													
Br	67883-LBC-6	67883-LBC-19	67883-LBC-27	67883-LBC-38	67883-LBC-56	18,5W	1950	220-240V [500mA]	3000	>90	22,5W	1755	78
Ne	67884-LBC-6	67884-LBC-19	67884-LBC-27	67884-LBC-38	67884-LBC-56								
Gr	67885-LBC-6	67885-LBC-19	67885-LBC-27	67885-LBC-38	67885-LBC-56								
Br	67883-LBN-6	67883-LBN-19	67883-LBN-27	67883-LBN-38	67883-LBN-56	18,5W	2085	220-240V [500mA]	4000	>90	22,5W	1875	83
Ne	67884-LBN-6	67884-LBN-19	67884-LBN-27	67884-LBN-38	67884-LBN-56								
Gr	67885-LBN-6	67885-LBN-19	67885-LBN-27	67885-LBN-38	67885-LBN-56								
DALI DIM-DALI/PUSH													
Br	67840LBC6-DA	67840LBC19-DA	67840LBC27-DA	67840LBC38-DA	67840LBC56-DA	18,5W	1950	220-240V [500mA]	3000	>90	22,5W	1755	78
Ne	67841LBC6-DA	67841LBC19-DA	67841LBC27-DA	67841LBC38-DA	67841LBC56-DA								
Gr	67842LBC6-DA	67842LBC19-DA	67842LBC27-DA	67842LBC38-DA	67842LBC56-DA								
Br	67840LBN6-DA	67840LBN19-DA	67840LBN27-DA	67840LBN38-DA	67840LBN56-DA	18,5W	2085	220-240V [500mA]	4000	>90	22,5W	1875	83
Ne	67841LBN6-DA	67841LBN19-DA	67841LBN27-DA	67841LBN38-DA	67841LBN56-DA								
Gr	67842LBN6-DA	67842LBN19-DA	67842LBN27-DA	67842LBN38-DA	67842LBN56-DA								

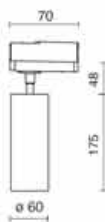

ACC. Bi 990925 Basetta plafone per adattatore elettrico (solo per versione on-off)
Ne 990926 Ceiling base for electric adaptor (only for on-off version)



Bi 990930 Adattatore per incasso basetta
Ne 990931 Recessed base adaptor



ALIMENTATORI-KIT RGB (se non in dotazione) da ordinare dalla sezione arancio - DRIVERS-RGB KITS (when not supplied) to be ordered from the section orange color

VERSIONE BASETTA - BASE VERSION

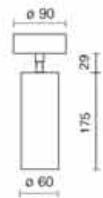

						LED					SISTEMA-SYSTEM			
						W	lm	V	K	CRI	W	lm	W	
 	Br	67880-LBC-6	67880-LBC-19	67880-LBC-27	67880-LBC-38	67880-LBC-56	18,5W	1950	220-240V [500mA]	3000	>90	22,5W	1755	78
	Ne	67881-LBC-6	67881-LBC-19	67881-LBC-27	67881-LBC-38	67881-LBC-56								
	Gr	67882-LBC-6	67882-LBC-19	67882-LBC-27	67882-LBC-38	67882-LBC-56								
 	Br	67880-LBN-6	67880-LBN-19	67880-LBN-27	67880-LBN-38	67880-LBN-56	18,5W	2085	220-240V [500mA]	4000	>90	22,5W	1875	83
	Ne	67881-LBN-6	67881-LBN-19	67881-LBN-27	67881-LBN-38	67881-LBN-56								
	Gr	67882-LBN-6	67882-LBN-19	67882-LBN-27	67882-LBN-38	67882-LBN-56								

VERSIONE BINARIO MAGNETICO - MAGNET TRACK VERSION

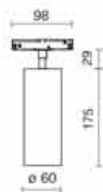

						LED					SISTEMA-SYSTEM			
						W	lm	V	K	CRI	W	lm	W	
 	ON-OFF						18,5W	1950	48Vdc	3000	>90	22,5W	1755	78
	Br	67845-LBC-6	67845-LBC-19	67845-LBC-27	67845-LBC-38	67845-LBC-56								
	Ne	67846-LBC-6	67846-LBC-19	67846-LBC-27	67846-LBC-38	67846-LBC-56								
 	Br	67845-LBN-6	67845-LBN-19	67845-LBN-27	67845-LBN-38	67845-LBN-56	18,5W	2085	48Vdc	4000	>90	22,5W	1875	83
	Ne	67846-LBN-6	67846-LBN-19	67846-LBN-27	67846-LBN-38	67846-LBN-56								
	Gr	67847-LBN-6	67847-LBN-19	67847-LBN-27	67847-LBN-38	67847-LBN-56								

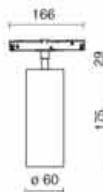

						LED					SISTEMA-SYSTEM			
						W	lm	V	K	CRI	W	lm	W	
 	DALI DIM-DALI/PUSH						18,5W	1950	48Vdc	3000	>90	22,5W	1755	78
	Br	67845LBC6-DA	67845LBC19-DA	67845LBC27-DA	67845LBC38-DA	67845LBC56-DA								
	Ne	67846LBC6-DA	67846LBC19-DA	67846LBC27-DA	67846LBC38-DA	67846LBC56-DA								
 	Br	67845LBN6-DA	67845LBN19-DA	67845LBN27-DA	67845LBN38-DA	67845LBN56-DA	18,5W	2085	48Vdc	4000	>90	22,5W	1875	83
	Ne	67846LBN6-DA	67846LBN19-DA	67846LBN27-DA	67846LBN38-DA	67846LBN56-DA								
	Gr	67847LBN6-DA	67847LBN19-DA	67847LBN27-DA	67847LBN38-DA	67847LBN56-DA								

OP. A richiesta - On request:

Cornice frontale - Front ring

Br	3126-1
Ne	3126-2
Oro	3126-3
Silver	3126-4
	3126-5

Colore a richiesta - on request colour

CODE.../FS Versione corpo con palpebra inclinata
Body with inclined eyelid version

CODE.../CA Versione con driver CASAMBI, solo per binario SITRACK
With driver CASAMBI version, only track SITRACK

ACC.

Br	3114	Cilindro di schermatura - Shielding cylinder	
Ne	3115		
Ne	3117	Griglia alveolare - Alveolar grid	
Ne	3119	Cono frangiluce Spillring - Cone louver grid Spillring	
	3121	Lente Ellittica - Elliptical lens	
	3123	Lente diffondente - Wide flood	





VEGA XS-XL BINARIO

- Corpo e struttura in estruso di alluminio verniciato in polveri epossidiche.
 - Vano ottico in pressofusione di alluminio verniciato in polveri.
 - Adattatore elettrico trifase.
 - Dissipatore passivo in estruso di alluminio ossidato nero.
 - Ottica orientabile con lenti in metacrilato.
 - Led durata utile: 50.000 (h) L80 B50.
- Housing and structure made of extruded aluminium painted in epoxy powder.
 - Die-cast aluminium optic.
 - Triphase electric adaptor.
 - Passive heatsink made of extruded aluminium.
 - Adjustable optic with methacrylate lens.
 - Led life: 50.000 (h) L80 B50.

		LED					SISTEMA-SYSTEM				
		W	lm	V	K	CRI	W	lm	lm/W		
	VEGA XS BINARIO										
	Br	67780-LBC	67780-LBC-60								
	Ne	67781-LBC	67781-LBC-60	16W	1280	220-240V [500mA]	3000	>90	16,5W	1150	69 [30°]
	Gr	67782-LBC	67782-LBC-60								
	Br	67780-LBN	67780-LBN-60								
	Ne	67781-LBN	67781-LBN-60	16W	1280	220-240V [500mA]	4000	>90	16,5W	1150	69 [30°]



		LED					SISTEMA-SYSTEM				
		W	lm	V	K	CRI	W	lm	lm/W		
	VEGA XL BINARIO										
	Br	67790-LBC	67790-LBC-60								
	Ne	67791-LBC	67791-LBC-60	24x2,5W	4600	220-240V [700mA]	3000	>90	64W	4150	65 [30°]
	Gr	67792-LBC	67792-LBC-60								
	Br	67790-LBN	67790-LBN-60								
	Ne	67791-LBN	67791-LBN-60	24x2,5W	4600	220-240V [700mA]	4000	>90	64W	4150	65 [30°]

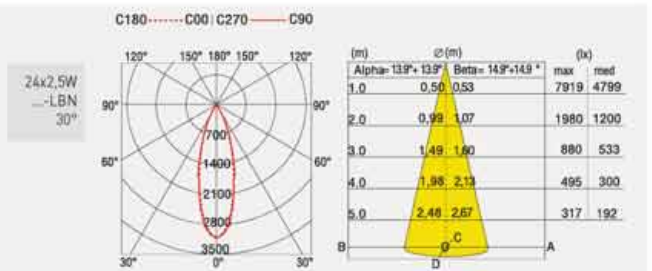
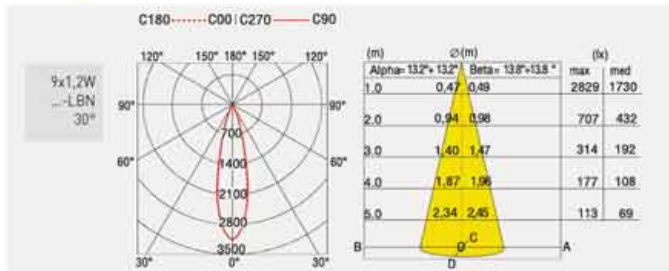

ALIMENTATORI-KIT RGB (se non in dotazione) da ordinare dalla sezione arancio - DRIVERS-RGB KITS (when not supplied) to be ordered from the section orange color



3ª PEÇA
GRÁTIS

CALÇ. & JEA

3ª PEÇA
GRÁTIS

BIG BINARIO 270-360



- Verniciatura per interni in polveri epossidiche.
- Disco fissaggio e dissipazione Led in alluminio.
- Diffusore in metacrilato bi-satinato.
- Morsetto ad innesto rapido per collegamento cavo di alimentazione.
- Schermo diffusore in metacrilato bi-satinato.
- Struttura interna in lamiera di acciaio pre-zincata.
- Pressacavo in gomma siliconica.
- Braccio orientabile regolabile 90°.
- Adattatore universale da binario.
- Led durata utile: 50.000 (h) L70 B10.
- **UGR <19 su richiesta.**



- Indoor epoxy powder painting.
- Aluminium fixing disk and heatsink.
- Bi-satin methacrylate diffuser.
- Quick connect terminal for connecting the network cable.
- Bi-satin methacrylate lower diffuser.
- Indoor pre galvanized steel sheet structure.
- Cable gland in silicon rubber.
- 90° adjustable.
- Universal track adaptor.
- Led life: 50.000 (h) L70 B10.
- **UGR <19 on request.**

	LED	SISTEMA-SYSTEM						
		W	lm	W				
BIG BINARIO 270	W	lm	V	K	CRI	W	lm	W
Br 5505EU-LBC	14W	1800	220-240V	3000	>80	16W	1442	90
Ne 5506EU-LBC			[500mA]					
Gr 5507EU-LBC								
Br 5505EU-LBN	14W	1950	220-240V	4000	>80	16W	1563	98
Ne 5506EU-LBN			[500mA]					
Gr 5507EU-LBN								
BIG BINARIO 360	W	lm	V	K	CRI	W	lm	W
Br 5513EU-LBC	18W	2600	220-240V	3000	>80	21W	2089	99
Ne 5514EU-LBC			[700mA]					
Gr 5515EU-LBC								
Br 5513EU-LBN	18W	2840	220-240V	4000	>80	21W	2282	109
Ne 5514EU-LBN			[700mA]					
Gr 5515EU-LBN								

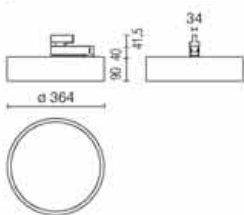
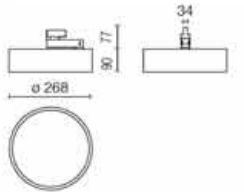

GR. A richiesta - On request: disponibile **VERSIONE UGR-19** - Available **VERSION UGR-19**

ACC. 409600 Schermo **DIAMOND PRISM** per versione UGR - **DIAMOND PRISM** diffuser for UGR version

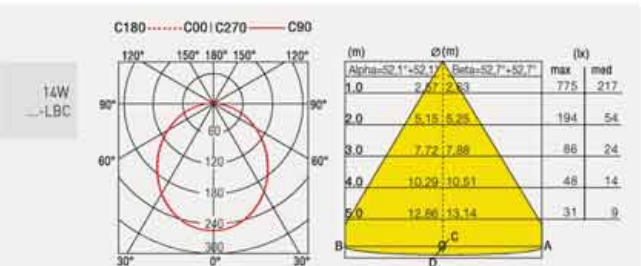
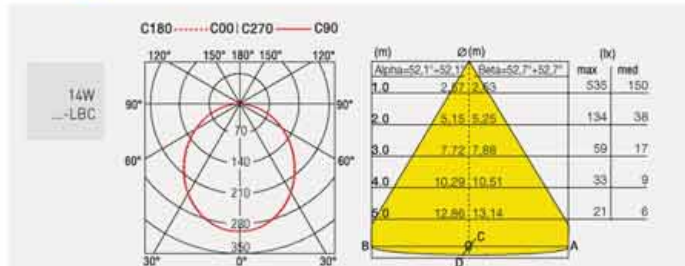

ALIMENTATORI-KIT RGB (se non in dotazione) da ordinare dalla sezione arancio - DRIVERS-RGB KITS (when not supplied) to be ordered from the section orange color

SOLARIS MINI BINARIO

- Corpo in pressofusione di alluminio.
- Verniciatura in polveri epossidiche con trattamento speciale per esterni.
- Riflettore in alluminio purissimo, finitura PVD.
- Vetro di protezione chiaro serigrafato temprato.
- Guarnizioni e passacavo in gomma siliconica.
- Led durata utile: 50.000 (h) L90 B20.
- Consistenza cromatica: 3 SDCM.

- Body in die-cast aluminium.
- Epoxy powder coated painting with special treatment for outdoors.
- Pure aluminium reflector, PVD finish.
- Tempered clear protection glass.
- Silicon rubber gaskets and cable gland.
- Led life: 50.000 (h) L90 B20.
- Chromatic consistency: 3 SDCM.



	SIM	AS	LED					SISTEMA-SYSTEM				
			W	lm	V	K	CRI	W	lm	lm/W		
	Br	67963-LBC	67969-LBC	12,4W	1510	220-240V (350mA)	3000	>90	14,4W	1120	78	SIM
	Ne	67964-LBC	67970-LBC							1154	73	AS
	Gr	67965-LBC	67971-LBC									
	Br	67963-LBN	67969-LBN	12,4W	1640	220-240V (350mA)	4000	>90	14,4W	1217	84	SIM
	Ne	67964-LBN	67970-LBN							1145	79	AS
	Gr	67965-LBN	67971-LBN									



SOLARIS MCL BINARIO



- Corpo in pressofusione di alluminio.
- Verniciatura in polveri epossidiche con trattamento speciale per esterni.
- Riflettore in alluminio purissimo, finitura PVD.
- Vetro di protezione chiaro serigrafato temprato.
- Guarnizioni e passacavo in gomma siliconica.
- Led durata utile: 50.000 (h) L90 B20.
- Consistenza cromatica: 3 SDCM.

- Body in die-cast aluminium.
- Epoxy powder coated painting with special treatment for outdoors.
- Pure aluminium reflector, PVD finish.
- Tempered clear protection glass.
- Silicon rubber gaskets and cable gland.
- Led life: 50.000 (h) L90 B20.
- Chromatic consistency: 3 SDCM.



	LED	SISTEMA-SYSTEM		
		W	lm	lm/W
 Br 67953-LBC Ne 67954-LBC Gr 67955-LBC	40W 5240	220-240V (600mA)	3000 >90	44W 5000 114
 Br 67953-LBN Ne 67954-LBN Gr 67955-LBN	40W 5980	220-240V (600mA)	4000 >90	44W 5396 123
 DIM-DALI/PUSH				
Br 67953-LBC-DA Ne 67954-LBC-DA Gr 67955-LBC-DA	40W 5540	220-240V (600mA)	3000 >90	44W 5000 114
Br 67953-LBN-DA Ne 67954-LBN-DA Gr 67955-LBN-DA	40W 5980	220-240V (600mA)	4000 >90	44W 5396 123

OP. A richiesta - On request: classe - class
 disponibile - available DIM 1+ 10V

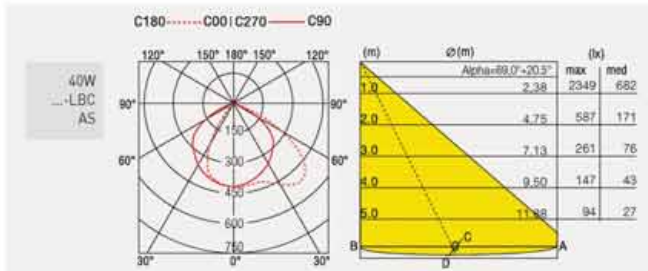

ALIMENTATORI-KIT RGB (se non in dotazione) da ordinare dalla sezione arancio - DRIVERS-RGB KITS (when not supplied) to be ordered from the section orange color



FASCIO STANDARD - STANDARD BEAM

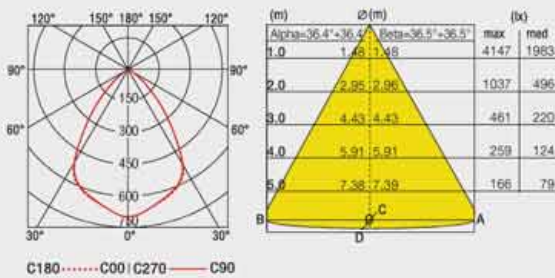

FASCIO DOPPIO ASIMMETRICO - DOUBLE ASYMMETRIC BEAM

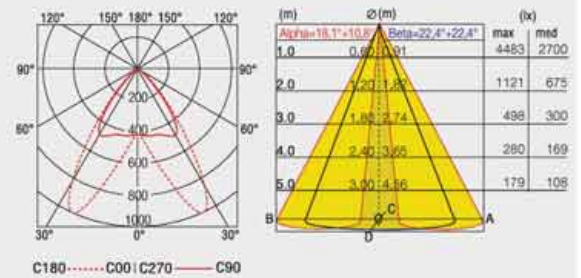

FASCIO DIFFUSO - DIFFUSED OPTIC

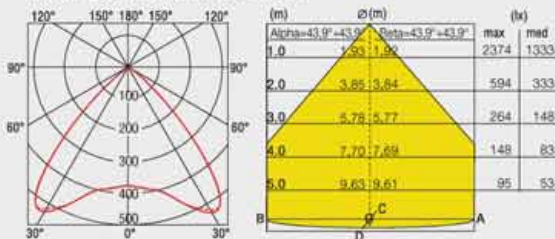

FASCIO ASIMMETRICO - ASYMMETRIC BEAM

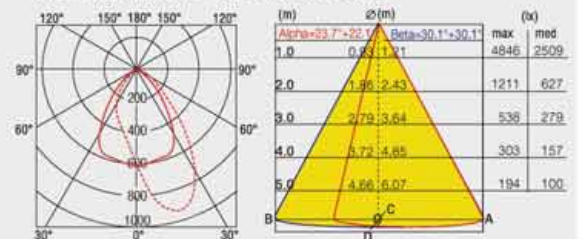



- Corpo in materiale termoplastico.
- Lente in PMMA.
- Dissipatore passivo.
- Temperatura esercizio -20° +35°.
- Pressacavo in nylon 66.
- Apparecchio conforme alle norme EN60598-1.
- Led durata utile: 50.000 (h) L80 B10.
- Consistenza cromatica: 3 SDCM.

- Body in thermoplastic material.
- PMMA lens.
- Passive heatsink.
- Operating temperature -20 ° + 35 °.
- Cable gland in nylon 66.
- Nylon cable gland 66.
- Fitting compliant to EN60598-1 standards.
- Led life: 50.000 (h) L80 B20.
- Chromatic consistency: 3 SDCM.

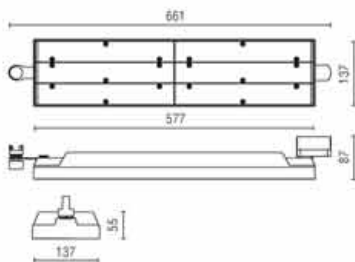

				LED					SISTEMA-SYSTEM			
	FS	FL	AS	BAS	W	lm	V	K	CRI	W	lm	lm
ON-OFF												
Br	4445-LBC	4447-LBC	4449-LBC	4451-LBC	43,5W	7020	220-240V [500mA]	3000	>80	47,5W	6894	145
Ne	4446-LBC	4448-LBC	4450-LBC	4452-LBC								
Br	4445-LBN	4447-LBN	4449-LBN	4451-LBN	43,5W	7385	220-240V [500mA]	4000	>80	47,5W	7233	152
Ne	4446-LBN	4448-LBN	4450-LBN	4452-LBN								
DALI DIM-DALI/PUSH												
Br	4445-LBC-DA	4447-LBC-DA	4449-LBC-DA	4451-LBC-DA	43,5W	7020	220-240V [500mA]	3000	>80	47,5W	6894	145
Ne	4446-LBC-DA	4448-LBC-DA	4450-LBC-DA	4452-LBC-DA								
Br	4445-LBN-DA	4447-LBN-DA	4449-LBN-DA	4451-LBN-DA	43,5W	7385	220-240V [500mA]	4000	>80	47,5W	7233	152
Ne	4446-LBN-DA	4448-LBN-DA	4450-LBN-DA	4452-LBN-DA								



ALIMENTATORI-KIT RGB (se non in dotazione) da ordinare dalla sezione arancio - DRIVERS-RGB KITS (when not supplied) to be ordered from the section orange color





MAGNET.G2 system



Gamma di binari elettrificati **MAGNET.G2** a bassa tensione dal design minimal ed elegante.

Le dimensioni ridotte li rendono quasi invisibili e particolarmente adatti ai vari progetti di illuminazione il cui obiettivo è focalizzare l'attenzione sull'oggetto illuminato. Magnet system consente una fusione totale con l'architettura.

Gli elementi plug-in ad innesto rapido consentono facilità e versatilità nell'installazione.

I binari **MAGNET.G2** a bassissima tensione consentono di posizionare, rimuovere e spostare gli apparecchi da accesi (in tensione) e quindi, di variare la configurazione in qualsiasi momento.

Tutto ciò comporta una versatilità estrema, velocità di intervento e sicurezza in fase di posizionamento dei corpi luminosi.

MAGNET.G2 series of electrified low voltage tracks with minimal and elegant design.

The small sizes make them almost invisible and particularly suitable for various lighting projects whose aim is to focus the attention on the illuminated object. Magnet system allows a total merger with the architecture. The plug-in elements allow an easy and versatile installation.

The very low voltage **MAGNET.G2** tracks allow to position, remove and move the switched fittings (under tension) and therefore to change the configuration at any time. It means extreme versatility, speed of intervention and safety during the placement of the products.

MAGNET.G2 BINARI - TRACKS

- Binario a bassissima tensione max 60Vdc 15A.
- Estruso in alluminio ossidato colore bianco o nero.
- Low voltage track max 60Vdc 15A.
- Structure in white or black oxidized aluminum.

BINARIO PLAFONE/SOSPENSIONE CEILING MOUNTED SUSPENSION TRACK



BINARIO SOSPENSIONE SUSPENSION TRACK



48 Vdc



L [mm]



BINARIO ST1 TRACK ST1

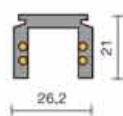

Bi	M-25101	1000	15A
Ne	M-25102		
Bi	M-25201	2000	15A
Ne	M-25202		
Bi	M-25301	3000	15A
Ne	M-25302		

TESTATA DI CHIUSURA ST1 END CAP ST1



Bi	M-99057
Ne	M-99058

TESTATA DI CHIUSURA CON FORO ST1 END CAP ST1 WITH HOLE FOR CABLE



Bi	M-99059
Ne	M-99060

STAFFA FISSAGGIO MECCANICO PER SOSPENSIONE MECHANICAL FIXING BRACKET FOR SUSPENSION



Bi	M-99061
Ne	M-99062

STAFFA PER SOSPENSIONE CON TENDITORE BRACKET FOR SUSPENSION WITH GRIPPER



Bi	M-99063
Ne	M-99064

48 Vdc



L [mm]



BINARIO ST2 TRACK ST2

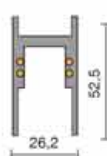

Bi	M-25101H	1000	15A
Ne	M-25102H		
Bi	M-25201H	2000	15A
Ne	M-25202H		
Bi	M-25301H	3000	15A
Ne	M-25302H		

TESTATA DI CHIUSURA ST2 END CAP ST2



Bi	M-99051
Ne	M-99052

TESTATA DI CHIUSURA CON FORO ST2 END CAP ST2 WITH HOLE FOR CABLE



Bi	M-99053
Ne	M-99054

STAFFA FISSAGGIO MECCANICO PER SOSPENSIONE ST2 MECHANICAL FIXING BRACKET ST2 FOR SUSPENSION



Als	M-99055
-----	---------

STAFFA PER SOSPENSIONE CON TENDITORE ST2 BRACKET FOR SUSPENSION ST2 WITH GRIPPER

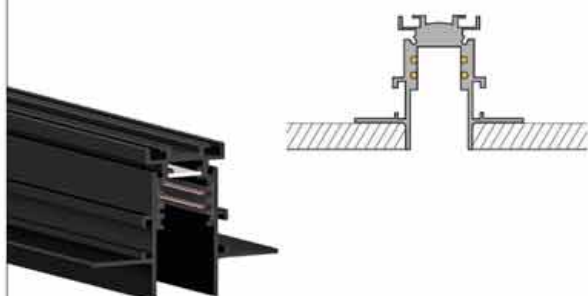

Als	M-99056
-----	---------

**BINARIO AD INCASSO
RECESSED TRACK**

48 Vdc

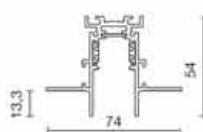

L (mm)

**BINARIO DA INCASSO ST5
RECESSED TRACK ST5**

Ne	M-26102	1000	15A
Ne	M-26202	2000	15A
Ne	M-26302	3000	15A

**TESTATA DI CHIUSURA ST2 - ST5
END CAP ST2 - ST5**

Ne M-99052

**CLIP CON TENDITORE AUTOMATICO
CLAMP WITH AUTOMATIC GRIPPER**

Als M-99076

**STAFFA, BARRA FILETTATA M6
E DADO PER FISSAGGIO A SOFFITTO PER SOSPENSIONE
BRACKET, M6 THREADED BAR AND NUT FOR CEILING MOUNTING**

Als M-99077

**STAFFA DI RINFORZO PER GIUNTO DIRETTO
REINFORCED BRACKET FOR DIRECT JOINTING**

Als M-99075







· Accessori per connessioni su binario a bassissima tensione max 60Vdc 15A.

· Accessories for connection on track with low voltage max 60Vdc 15A.



Bi **M-99040** TESTATA DI ALIMENTAZIONE
Ne **M-99041** PER BINARIO ST1 - ST2 - ST5
END FEED
FOR ST1 - ST2 - ST5 TRACK

NB. Collegare la testata di alimentazione a uno degli alimentatori consigliati.
Connect the live end to one of the recommended drivers.



Bi **M-99044** GIUNTO PASSANTE PER BINARIO ST1 - ST2 - ST5
Ne **M-99045** JOINING CONNECTOR FOR ST1 - ST2 - ST5 TRACK



Bi **M-99046** GIUNTO A L - L JOIN
Ne **M-99047**



Bi **M-99048** COPERTURA PER GIUNTO A L PER BINARIO ST2
Ne **M-99049** COVER FOR L JOINT FOR ST2 TRACK



acciaio **M-99050** STAFFA A L PER GIUNTI ANGOLARI
L BRACKET FOR ANGLES

ALIMENTATORI CONSIGLIATI - RECOMMENDED DRIVERS

646A33	50W	IP20	48 Vdc
646A34	75W	IP20	48 Vdc
646A35	120W	IP20	48 Vdc

MAGNET.G2 APPARECCHI LINEARI - LINEAR PRODUCTS

- Corpo e vano ottico in pressofusione di alluminio verniciato in polvere.
- Riflettore in policarbonato metallizzato in alto vuoto.
- Alimentatore elettronico.
- Led durata utile: 50.000 (h) L90 B5.
- Consistenza cromatica: 3 SDCM.

- Body of powder coated die-cast aluminum.
- High vacuum metallized polycarbonate reflector.
- Electronic driver.
- Led life: 50.000 (h) L90 B5.
- Chromatic constancy: 3 SDCM.

ESTRUSO LINEARE CON OTTICA QUADRATA UGR <19 ALUMINUM LINEAR STRUCTURE WITH SQUARE OPTIC UGR <19

48 Vdc

L [mm]	LED					SISTEMA-SYSTEM		
	W	lm	V	K	CRI	W	lm	IP
567	10,2W	1159	48Vdc	3000	>90	10,2W	1021	100
567	10,2W	1241	48Vdc	4000	>90	10,2W	1095	107
1128	18,2W	2087	48Vdc	3000	>90	18,2W	1838	100
1128	18,2W	2235	48Vdc	4000	>90	18,2W	1968	108

ESTRUSO LINEARE CON LENTI TONDE ALUMINUM LINEAR STRUCTURE WITH ROUND LENSES

48 Vdc

L [mm]	LED					SISTEMA-SYSTEM		
	W	lm	V	K	CRI	W	lm	IP
567	10,2W	1159	48Vdc	3000	>90	10,2W	1064	100
567	10,2W	1241	48Vdc	4000	>90	10,2W	1115	109
1128	18,2W	2087	48Vdc	3000	>90	18,2W	1890	104
1128	18,2W	2235	48Vdc	4000	>90	18,2W	2004	110

DP: *A richiesta - On request: apertura fascio - light beam - 26x42° ellittico - elliptical
 A richiesta - On request: Led con temperatura di COLORE 2700K - Temperatura Led COLOUR 2700K
 disponibile - available DIM 1+ 10V

18,2W
-LBC
60°

18,2W
-LBC
20°



- Corpo e vano ottico in pressofusione di alluminio verniciato in polvere.
- Schermo in policarbonato opale.
- Alimentatore elettronico.
- Led durata utile: 50.000 (h) L90 B5.
- Consistenza cromatica: 3 SDCM.

- Body of powder coated die-cast aluminum.
- Polycarbonate opal screen.
- Electronic driver.
- Led life: 50.000 (h) L90 B5.
- Cromatic constancy: 3 SDCM.

ESTRUSO LINEARE CON SCHERMO OPALE IN DIVERSE LUNGHEZZE PER LINEA CONTINUA LUMINOSA
ALUMINUM LINEAR STRUCTURE WITH OPAL SCREEN FOR CONTINUOUS LIGHT LINE

48 Vdc		L (mm)	LED					SYSTEM-SYSTEM			
			W	lm	V	K	CRI	W	lm	lm/W	
		Ne M-6002-LBC	567	11,9W	1488	48Vdc	3000	>90	11,9W	1005	85
		Ne M-6002-LBN	567	11,9W	1620	48Vdc	4000	>90	11,9W	1078	90
		Ne M-6004-LBC	1128	23,8W	2976	48Vdc	3000	>90	23,8W	2011	85
		Ne M-6004-LBN	1128	23,8W	3240	48Vdc	4000	>90	23,8W	2153	90
		Ne M-6006-LBC	1408	29,8W	3720	48Vdc	3000	>90	29,8W	2514	85
		Ne M-6006-LBN	1408	29,8W	4050	48Vdc	4000	>90	29,8W	2692	90

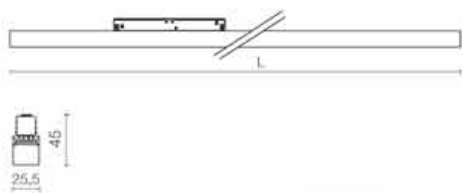

OP. A richiesta - On request: schermo microprismatico - microprismatic screen
 disponibile - available DIM 1+10V

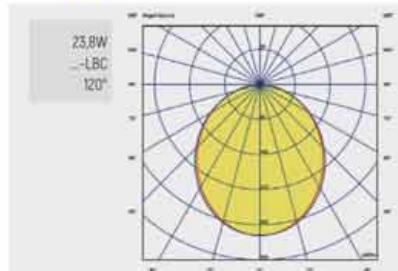

MAGNET.G2 APPARECCHI SPOT - SPOT PRODUCTS

- Corpo e vano ottico in pressofusione di alluminio verniciato in polvere.
- Riflettore in policarbonato metallizzato in alto vuoto.
- Alimentatore elettronico.
- Led durata utile: 50.000 (h) L80 B20.
- Consistenza cromatica: 3 SDCM.
- Body and optic in die-cast aluminum powder coated.
- High vacuum metallized polycarbonate reflector.
- Electronic driver.
- Led life: 50.000 (h) L80 B20.
- Chromatic constancy: 3 SDCM.

SPOT SINGOLO CON ADATTATORE SINGLE SPOT WITH ADAPTER

	LED	SISTEMA-SYSTEM							
		W	lm	lm/W					
		W	lm	V	K	CRI	W	lm	lm/W
Bi M-67383-LBC20 Ne M-67384-LBC20 0,155 Kg	12,4W	1580	24/48Vdc	3000	>80		13W	1390	107
Bi M-67383-LBN20 Ne M-67384-LBN20	12,4W	1550	24/48Vdc	3000	>80		13W	1450	112



SPOT DOPPIO CON ADATTATORE DOUBLE SPOT WITH ADAPTER

	LED	SISTEMA-SYSTEM							
		W	lm	lm/W					
		W	lm	V	K	CRI	W	lm	lm/W
Bi M-67386-LBC20 Ne M-67387-LBC20 0,31 Kg	24,8W	3160	24/48Vdc	3000	>80		26W	2780	107
Bi M-67386-LBN20 Ne M-67387-LBN20	24,8W	3300	24/48Vdc	4000	>80		26W	2900	112



OP: *A richiesta - On request: apertura fascio - light beam 

A richiesta - On request: disponibile - available 

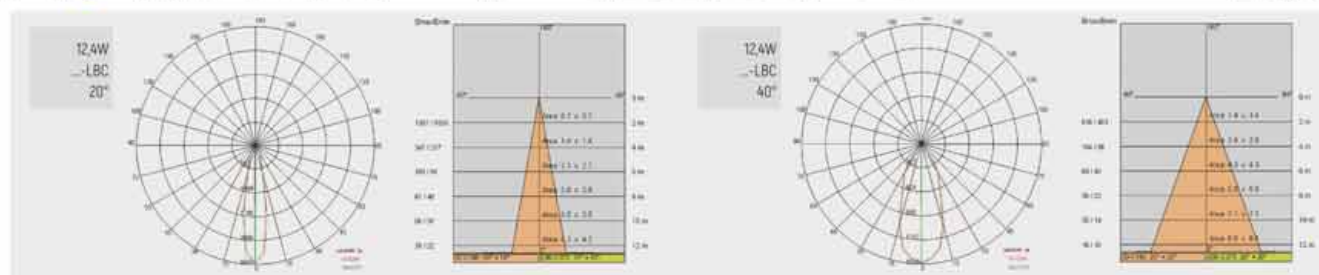

ALIMENTATORI-KIT RGB (se non in dotazione) da ordinare dalla sezione arancio - DRIVERS-RGB KITS (when not supplied) to be ordered from the section orange color

inside



- Corpo in estruso di alluminio verniciato, lunghezza 300 mm.
- Gruppo di alimentazione integrato.
- Led durata utile: 50.000 (h) L 80 B20
- Consistenza cromatica: 3 SDCM.

- Main body made of extruded aluminum, length 300 mm.
- Built-in power supply unit.
- Led life: 50.000 (h) L80 B20
- Cromatic constancy: 3 SDCM.

DROP 30S XS

	LED					SISTEMA-SYSTEM		
	W	lm	V	K	CRI	W	lm	W
Br M-D2210-LBC-S Ne M-D2211-LBC-S	3,5W	285	24/48Vdc	3000	>80	4,5W	257	57
Br M-D2210-LBN-S Ne M-D2211-LBN-S	3,5W	300	24/48Vdc	4000	>80	4,5W	287	64

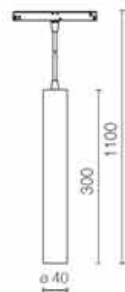

Kg
0,38



OP. A richiesta - On request: disponibile - available

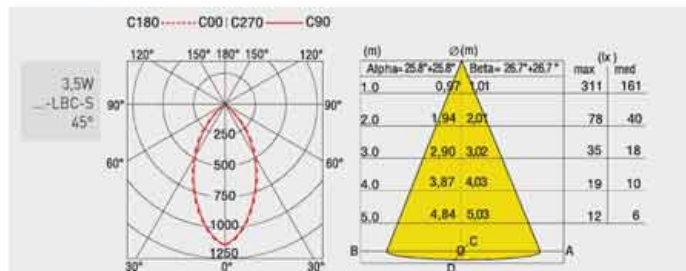

ALIMENTATORI-KIT RGB (se non in dotazione) da ordinare dalla sezione arancio - DRIVERS-RGB KITS (when not supplied) to be ordered from the section orange color





I PLUS DEI BINARI SITRACK

I binari elettrificati trifase SIDE S.P.A. offrono un'infrastruttura flessibile per apparecchi con diverse caratteristiche illuminotecniche che possono essere spostati o scambiati senza problemi. I singoli binari possono essere collegati tra loro tramite gli accessori per creare svariate forme.

Possono essere realizzati anche nella versione DALI.

I binari Sitrack grazie alla gamma di accessori consentono il montaggio in diverse situazioni:

le versioni da incasso, a plafone e quella per la sospensione con funi o tiges.

Binario a 5 conduttori con tre circuiti ad accensioni separate. È costituito da un profilo estruso in alluminio EN AB-47100 verniciato per interni in polveri epossidiche, che funziona anche da messa a terra, e da un inserto in plastica che alloggia n.4 conduttori di rame a sezione piatta di 3,3 mm² in coostrusione con isolamento in materiale termoplastico.

Il binario può essere tagliato sul posto di lavoro nelle dimensioni desiderate.

THE ADVANTAGES OF SITRACK TRACKS

SIDE SPA three-phase electrified tracks provide a flexible infrastructure for lighting fixtures with different beams and optics that can be easily moved and positioned. Single tracks can be connected to each other through the accessories and create various shapes.

They can also be produced in DALI version. Sitrack tracks, thanks to the wide accessories range, can be installed in different situations: recessed, ceiling mounted and suspended (with cable or tiges).

5 track conductors with three separate switching circuits. It consists of an extruded aluminum profile EN AB-47100 painted with epoxy powder for indoor usage, which also grants earthing and a plastic insert that houses 4 flat copper conductors of 3.3 mm² co-extruded with thermoplastic insulating material. The track can be cut on site.

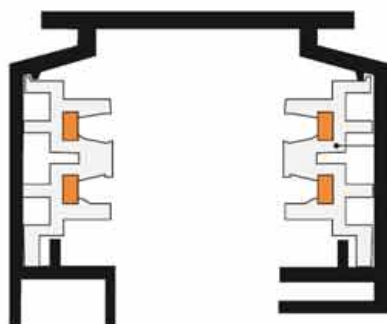

Inserto in plastica che alloggia n.4 conduttori di rame a sezione piatta di 3,3mm² in coostrusione con isolamento PVC. La coostrusione permette che in fase di taglio dei binari non avvenga il distacco dei conduttori dal materiale termoplastico.

Plastic insert that houses 4 flat section copper conductors of 3.3 mm² co-extruded with PVC insulation. The extrusion prevents the detachment of plastic and conductors while cutting the tracks.

SITRACK 230V

BINARIO PER MONTAGGIO A PLAFONE - TRACK FOR CEILING MOUNTING

- Binario a 5 conduttori con tre circuiti ad accensioni separate. È costituito da un profilo di alluminio estruso, che funziona anche da terra, e da un inserto in plastica che alloggia 4 conduttori in rame di 3 mm². Il binario può essere tagliato sul posto di lavoro nelle dimensioni desiderate. Non è necessario tagliare o piegare i conduttori di rame. Il binario ha dei fori predisposti per il fissaggio.
- A 5 conductor track with three separately switchable circuits. It consists of an extruded aluminium profile, which also functions as earth, and an inserted bent profile carrying 4 embedded 3 mm² copper conductors. The track can be cut to length at site. It is not necessary to cut or bend back the copper wire. The track has pre-punched holes for fixation.



**BINARIO TRIFASE
3 CIRCUIT TRACK**

UL US LISTED

ENE C - ITALIA

Br	25101	Lunghezza 1 m. Length 1 m.
Ne	25102	
Gr	25103	
Br	25201	Lunghezza 2 m. Length 2 m.
Ne	25202	
Gr	25203	
Br	25301	Lunghezza 3 m. Length 3 m.
Ne	25302	
Gr	25303	
Br	25401	Lunghezza 4 m. Length 4 m.
Ne	25402	
Gr	25403	

**TESTATA DI ALIMENTAZIONE
LIVE END**

Bi	990241	Contatto sinistro di messa a terra Left earth contact
Ne	990242	
Bi	990251	Contatto destro di messa a terra Right earth contact
Ne	990252	

**CONGIUNZIONE RETTILINEA
STRAIGHT COUPLER**

Bi	990371	
Ne	990372	

**ALIMENTATORE CENTRALE
STRAIGHT COUPLER FOR
CENTRAL FEEDING**

Bi	990781	
Ne	990782	

**STAFFA DI FISSAGGIO MECCANICO
MECHANICAL FIXING CLIP**

Bi	990741	
Ne	990742	

**CONGIUNZIONE A 90°
90° COUPLER**

Bi	990791	Contatto di terra esterno Outside earth contact
Ne	990792	
Bi	990271	Contatto di terra interno Inside earth contact
Ne	990272	

**CONGIUNZIONE A T
T COUPLER FOR SURFACE**

Bi	990289	Contatto di terra destro esterno Right outside earth contact
Ne	990290	
Bi	990293	Contatto di terra sinistro esterno Left outside earth contact
Ne	990294	
Bi	990291	Contatto di terra destro interno Right inside earth contact
Ne	990292	
Bi	990301	Contatto di terra sinistro interno Left inside earth contact
Ne	990302	

**CONGIUNZIONE A X
X COUPLER FOR SURFACE**

Bi	990311	
Ne	990312	

**CURVA FLESSIBILE
FLEXIBLE CURVE**

Bi	990331	
Ne	990332	

**COPRIBINARIO
TRACK COVER**

Bi	990341	Lunghezza 1 m. Length 1 m.
Ne	990342	





• Binario a 5 conduttori con tre circuiti ad accensioni separate. È costituito da un profilo di alluminio estruso, che funziona anche da terra, e da un inserto in plastica che alloggia 4 conduttori in rame di 3 mm². Il binario può essere tagliato sul posto di lavoro nelle dimensioni desiderate. Non è necessario tagliare o piegare i conduttori di rame. Il binario ha dei fori predisposti per il fissaggio.

• A 5 conductor track with three separately switchable circuits. It consists of an extruded aluminium profile, which also functions as earth, and an inserted bent profile carrying 4 embedded 3 mm² copper conductors. The track can be cut to length at site. It is not necessary to cut or bend back the copper wire. The track has pre-punched holes for fixation.



TESTATA DI CHIUSURA
END CAP

Bi 990351
Ne 990352



RACCORDO PER ADATTATORE 100N
NIPPLE FOR ADAPTOR 100N

588123 M13X1
588223 M10X1

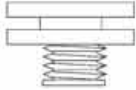

RACCORDO PER ADATTATORE 50N
NIPPLE FOR ADAPTOR 50N

Bi 644579 M10X1
Ne 644580 M13X1



ADATTATORE 100N
ADAPTOR 100N

Bi 990991 Adattatore meccanico universale
Ne 990992 Universal mechanical adaptor

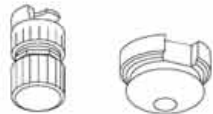

Bi 990831 Bloccacavo per adattatore
Ne 990832 Cable clamp for adaptor

ADATTATORE 100N
ADAPTOR 100N

Bi 990921
Ne 990922

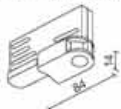

ADATTATORE 50N
ADAPTOR 50N

Bi 644522
Ne 644523

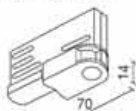

STAFFA
CLIP

Bi 990751
Ne 990752

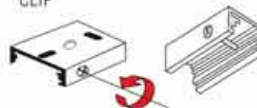

Staffa per montaggio a soffitto o a sospensione
Clip for surface or pendant mounting.

TIGES

Bi 999051 Tiges con rosone per montaggio a sospensione L 600 mm.
Ne 999052 Tiges for pendant mounting L 600 mm

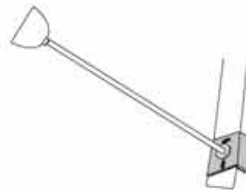

Bi 999061 Tiges con rosone per montaggio a sospensione L 1200 mm.
Ne 999062 Tiges for pendant mounting L 1200 mm

KIT

Bi 7011 Kit sospensione a filo L 3 m. per sospensione ordinare anche staffa codice 990751-990752
Wire suspension kit L 3 m for suspension, you should order also art. 990751-990752

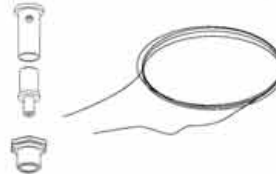

N.B: Cavetto acciaio - sez. 1,76 mm² - portata max 50 Kg. Carico di rottura 290 Kg.
NOTE: Steel cable - section 1,76 mm² - maximum capacity of 50 Kg. Actual breaking load 290 Kg.

BASSETTA PLAFONE PER ADATTATORE (solo per versione on-off)
CEILING BASE FOR ADAPTOR (only for on-off version)

Bi 990925
Ne 990926

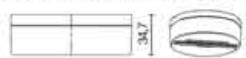

Compatibile con adattatori carico Max 50n - Compatible with max 50N load adapters

ADATTATORE INCASSO BASETTA
RECESSED BASE ADAPTOR

Bi 990930
Ne 990931



108,5 mm

N.B: Per applicazione ad incasso ordinare [Es.] codice 990925 - 990930
NOTE: For recessed application order [Ex] code 990925 - 990930

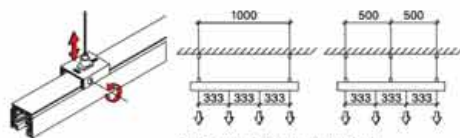

Carico massimo per sospensioni
Maximum mechanical load for suspensions

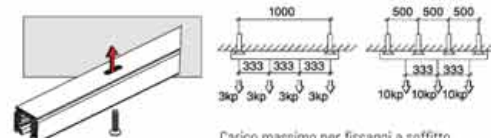

Carico massimo per fissaggi a soffitto
Maximum mechanical load for ceiling mounting





· Binario a 5 conduttori con tre circuiti ad accensioni separate. È costituito da un profilo in alluminio estruso, che funziona anche da terra, e da un inserto in plastica che alloggia 4 conduttori in rame di 3 mm². Il binario può essere tagliato sul posto di lavoro nelle dimensioni desiderate. Non è necessario tagliare o piegare i conduttori di rame. Il binario ha dei fori predisposti per il fissaggio. Se vengono utilizzate le testate di chiusura a incasso è necessario accorciare i conduttori di rame e il profilo in plastica di una lunghezza pari allo spessore delle testate stesse.

· A 5 conductor track with three separately switchable circuits. It consists of an extruded aluminum profile, which also functions as earth, and an inserted bent profile carrying 4 embedded 3 mm² copper conductors. The track can be cut to length at site. It is not necessary to cut or bend back the copper wire. The track has pre-punched holes for fixation. In case of use of the recessed end caps, it is necessary to cut the copper conductors and the plastic profile at a length equal to the thickness of these end caps.



BINARIO TRIFASE 3 CIRCUIT TRACK

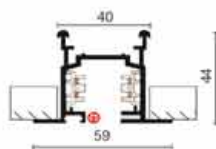

Br 26101	Lunghezza 1 m.
Ne 26102	Lenght 1 m.
Gr 26103	
Br 26201	Lunghezza 2 m.
Ne 26202	Lenght 2 m.
Gr 26203	
Br 26301	Lunghezza 3 m.
Ne 26302	Lenght 3 m.
Gr 26303	
Br 26401	Lunghezza 4 m.
Ne 26402	Lenght 4 m.
Gr 26403	

CONGIUNZIONE RETTILINEA STRAIGHT COUPLER



Bi 990381	Per montaggio da incasso
Ne 990382	For recessed mounting

ALIMENTAZIONE CENTRALE STRAIGHT COUPLER FOR CENTRAL FEEDING



Bi 993321	Per montaggio da incasso
	For recessed mounting

TESTATA DI CHIUSURA END CAP



Bi 993381	Per incasso
Ne 993382	For mounting

MOLLA SNAP KIT x 6



Bi 992590	Molla supporto profilo
	6 pezzi
	Profile snape hanger
	for tension grip 6 pieces

RACCORDO PER ADATTATORE 100N NIPPLE FOR ADAPTOR 100N



588123	M13X1
588223	M10X1

RACCORDO PER ADATTATORE 50N NIPPLE FOR ADAPTOR 50N



Bi 644579	M10X1
Ne 644580	M13X1

IP 20

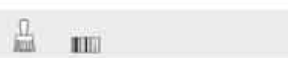

ADATTATORE 100N ADAPTOR 100N

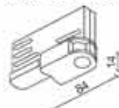

Bi 990921	
Ne 990922	

ADATTATORE 50N ADAPTOR 50N

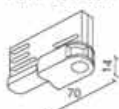

Bi 644522	
Ne 644523	

TESTATA DI ALIMENTAZIONE LIVE END



Bi 993241	Contatto sinistro di
Ne 993242	messa a terra
	Left earth contact
Bi 993251	Contatto destro di
Ne 993252	messa a terra
	Right earth contact

CONGIUNZIONE A 90° 90° COUPLER FOR SURFACE

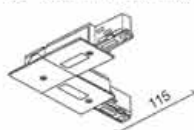

Bi 993271	Contatto di terra
Ne 993272	esterno
	Outside earth contact
Bi 993261	Contatto di terra
Ne 993262	interno
	Inside earth contact

CONGIUNZIONE A T T COUPLER FOR SURFACE

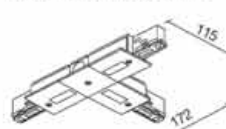

Bi 993282	Contatto di terra
Ne 993284	destro esterno
	Right outside earth contact
Bi 993332	Contatto di terra
Ne 993333	sinistro esterno
	Left outside earth contact
Bi 993281	Contatto di terra
Ne 993283	destro interno
	Right inside earth contact
Bi 993331	Contatto di terra
Ne 993334	sinistro interno
	Left inside earth contact

CONGIUNZIONE A X X COUPLER

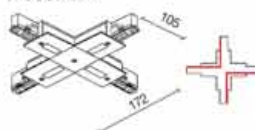

Bi 993291	
Ne 993292	

COPRIBINARIO TRACK COVER



Bi 359100	Lunghezza 1 m.
	Lenght 1 m.

SITRACK DALI

BINARIO PER MONTAGGIO A PLAFONE - TRACK FOR CEILING MOUNTING

• Binario a 5 conduttori con tre circuiti ad accensioni separate + 2 conduttori per bus.
È costituito da un profilo di alluminio estruso, che funziona anche da terra, e da un inserto in plastica che alloggia 4 conduttori in rame di 3 mm². Il binario può essere tagliato sul posto di lavoro nelle dimensioni desiderate. Non è necessario tagliare o piegare i conduttori di rame. Il binario ha dei fori predisposti per il fissaggio.

• A 5 conductor track with three separately switchable circuits + 2 conductor for bus. It consists of an extruded aluminium profile, which also functions as earth, and an inserted bent profile carrying 4 embedded 3 cm. copper conductors. The track can be cut to length at site. It is not necessary to cut or bend back the copper wire. The track has pre-punched holes for fixation.



• Sezione conduttore BUS in rame 1 mm²
• Section of copper conductor BUS 1 mm²



BINARIO TRIFASE 3 CIRCUIT TRACK

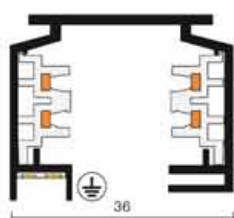

Br	25101-BUS	Lunghezza 1 m.
Ne	25102-BUS	Lenght 1 m.
Gr	25103-BUS	
Br	25201-BUS	Lunghezza 2 m.
Ne	25202-BUS	Lenght 2 m.
Gr	25203-BUS	
Br	25301-BUS	Lunghezza 3 m.
Ne	25302-BUS	Lenght 3 m.
Gr	25303-BUS	
Br	25401-BUS	Lunghezza 4 m.
Ne	25402-BUS	Lenght 4 m.
Gr	25403-BUS	

TESTATA DI ALIMENTAZIONE LIVE END

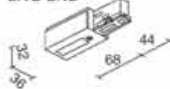

Bi	555212021	Contatto sinistro di messa a terra
Ne	555212022	Left earth contact
Bi	555212011	Contatto destro di messa a terra
Ne	555212012	Right earth contact

CONGIUNZIONE RETTILINEA STRAIGHT COUPLER



Bi	555212061
Ne	555212062

CONGIUNZIONE A T T COUPLER FOR SURFACE

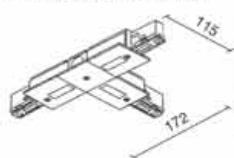

Bi	555212131	Contatto sinistro interno di messa a terra
Ne	555212132	Inside left earth contact
Bi	555212121	Contatto destro interno di messa a terra
Ne	555212122	Inside right earth contact
Bi	555212151	Contatto sinistro esterno di messa a terra
Ne	555212152	Outside left earth contact
Bi	555212141	Contatto destro esterno di messa a terra
Ne	555212142	Outside right earth contact

CONGIUNZIONE A X X COUPLER

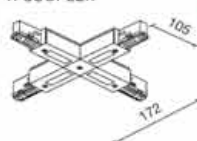

Bi	555212161
Ne	555212162



CONGIUNZIONE A 90° 90° COUPLER FOR SURFACE

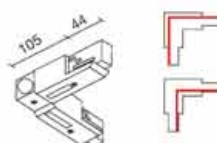

Bi	555212091	Contatto esterno di messa a terra
Ne	555212092	Outside earth contact
Bi	555212101	Contatto interno di messa a terra
Ne	555212102	Inside earth contact

TESTATA DI CHIUSURA END CAP



Bi	990351
Ne	990352

CONTATTI BUS BUS CONTACTS

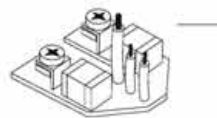

996980

DA ORDINARE INSIEME
TO BE ORDERED TOGETHER

ADATTATORE 100N ADAPTOR 100N



Bi	990921
Ne	990922

COPRIBINARIO TRACK COVER



Bi	990341	Lunghezza 1 m.
Ne	990342	Lenght 1 m.





• Binario a 5 conduttori con tre circuiti ad accensioni separate + 2 conduttori per bus. È costituito da un profilo di alluminio estruso, che funziona anche da terra, e da un inserto in plastica che alloggia 4 conduttori in rame di 3 mm². Il binario può essere tagliato sul posto di lavoro nelle dimensioni desiderate. Non è necessario tagliare o piegare i conduttori di rame. Il binario ha dei fori predisposti per il fissaggio.

• A 5 conductor track with three separately switchable circuits + 2 conductor for bus. It consists of an extruded aluminium profile, which also functions as earth, and an inserted bent profile carrying 4 embedded 3 cm. copper conductors. The track can be cut to length at site. It is not necessary to cut or bend back the copper wire. The track has pre-punched holes for fixation.



RACCORDO PER ADATTATORE 100N NIPPLE FOR ADAPTOR 100N

Bi 588123 M13X1
Ne 588223 M10X1



ADATTATORE 100N ADAPTOR 100N

Bi 990991 Adattatore meccanico
Ne 990992 universale
max 100n (10Kp)
Universal mechanical
adaptor



Bi 990831 Bloccacavo per adattatore
Ne 990832 Cable clamp for adaptor

STAFFA CLIP

Bi 990751 Staffa per montaggio
Ne 990752 a soffitto o a sospensione
Clip for surface or
pendant mounting

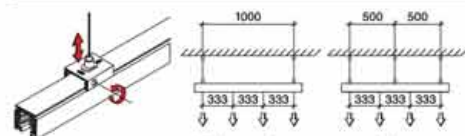
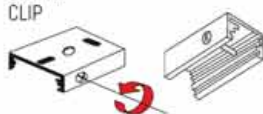

Carico massimo per sospensioni
Maximum mechanical load for suspensions



TIGES

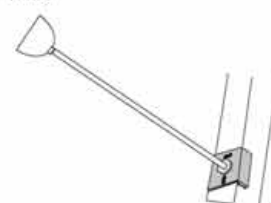

Bi 999051 Tiges con rosone per
Ne 999052 montaggio a sospensione
L= 600 mm.
Tiges for pendant mounting
L= 600 mm.

Bi 999061 Tiges con rosone per
Ne 999062 montaggio a sospensione
L= 1200 mm.
Tiges for pendant mounting
L= 1200 mm.

KIT

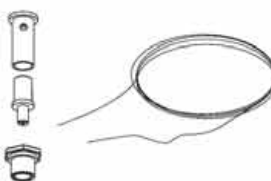

Bi 7011 Kit sospensione a filo
L 3 m. per sospensione
Da abbinare a staffa
990751-990752

Wire suspension kit
L 3 m. for suspension
To combine with clip
code 990751-990752

N.B: Cavetto acciaio - sez. 1,76 mm² - portata max 50 Kg. Carico di rottura 290 Kg.
NOTE: Steel cable - section 1,76 mm² - maximum capacity of 50 Kg. Actual breaking load 290 Kg.

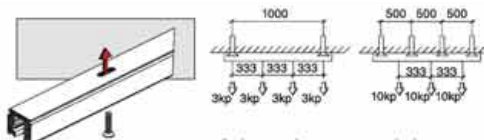

Carico massimo per sospensioni
Maximum mechanical load for mounting





· Binario a 5 conduttori con tre circuiti ad accensioni separate. È costituito da un profilo in alluminio estruso, che funziona anche da terra, e da un inserto in plastica che alloggia 4 conduttori in rame di 3 mm². Il binario può essere tagliato sul posto di lavoro nelle dimensioni desiderate. Non è necessario tagliare o piegare i conduttori di rame. Il binario ha dei fori predisposti per il fissaggio. Se vengono utilizzate le testate di chiusura a incasso è necessario accorciare i conduttori di rame e il profilo in plastica di una lunghezza pari allo spessore delle testate stesse.

· A 5 conductor track with three separately switchable circuits. It consists of an extruded aluminium profile, which also functions as earth, and an inserted bent profile carrying 4 embedded 3 mm² copper conductors. The track can be cut to length at site. It is not necessary to cut or bend back the copper wire. The track has pre-punched holes for fixation. In case of use of the recessed end caps, it is necessary to cut the copper conductors and the plastic profile at a length equal to the thickness of these end caps.



BINARIO TRIFASE 3 CIRCUIT TRACK

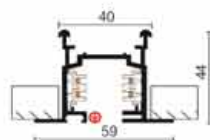

Br 26201-BUS Lunghezza 2 m
Ne 26202-BUS Length 2 m.
Gr 26203-BUS

Br 26301-BUS Lunghezza 3m
Ne 26302-BUS Length 3 m.
Gr 26303-BUS

Br 26401-BUS Lunghezza 4 m
Ne 26402-BUS Length 4 m.
Gr 26403-BUS

CONGIUNZIONI RETTILINEA STRAIGHT COUPLER



Bi 555232061 Per montaggio da incasso
Ne 555232062 For recessed mounting

ALIMENTATORE CENTRALE STRAIGHT COUPLER FOR CENTRAL FEEDING

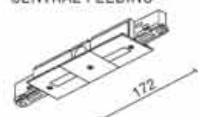

Bi 555252031 Per montaggio da incasso
Ne 555255032 For recessed mounting

TESTATA DI CHIUSURA END CAP



Bi 993381 Per incasso
Ne 993382 For mounting

MOLLA SNAP



KIT x 6

Bi 992590 Molla supporto profilo
6 pezzi
Profile snape hanger
for tension grip 6 pieces

RACCORDO PER ADATTATORE 100N NIPPLE FOR ADAPTOR 100N



588123 M13X1
588223 M10X1

RACCORDO PER ADATTATORE 50N NIPPLE FOR ADAPTOR 50N

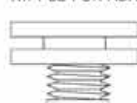

Bi 644579 M10X1
Ne 644580 M13X1



CONTATTI BUS BUS CONTACTS

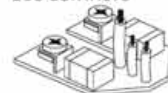

996980

DA ORDINARE INSIEME
TO BE ORDERED TOGETHER

ADATTATORE 100N ADAPTOR 100N



Bi 990921
Ne 990922

TESTATA DI ALIMENTAZIONE LIVE END



Bi 555232021 Contatto sinistro
di messa a terra
Left earth contact
Ne 555232022

Bi 555232011 Contatto destro
di messa a terra
Right earth contact
Ne 555232012

CONGIUNZIONE A 90° L COUPLER FOR SURFACE



Bi 555232091 Contatto sinistro
di messa a terra
Left earth contact
Ne 555232092

Bi 555232101 Contatto destro
di messa a terra
Right earth contact
Ne 555232102

CONGIUNZIONE A T T COUPLER FOR SURFACE

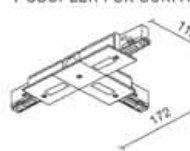

Bi 555232131 Contatto sinistro
interno di messa a terra
Inside left earth contract
Ne 555232132

Bi 555232121 Contatto destro
interno di messa a terra
Inside right earth contract
Ne 555232122

Bi 555232151 Contatto sinistro
esterno di messa a terra
Outside left earth contract
Ne 555232152

Bi 555232141 Contatto destro
esterno di messa a terra
Outside right earth contract
Ne 555232142

CONGIUNZIONE A X X COUPLER

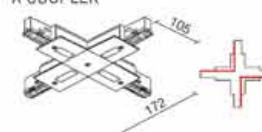

Bi 555232161 Per incasso
Ne 555232162 For mounting

COPRIBINARIO TRACK COVER



Bi 990341 Lunghezza 1 m.
Ne 990342 Length 1 m.





*In fase di approvazione - Under approval



inside

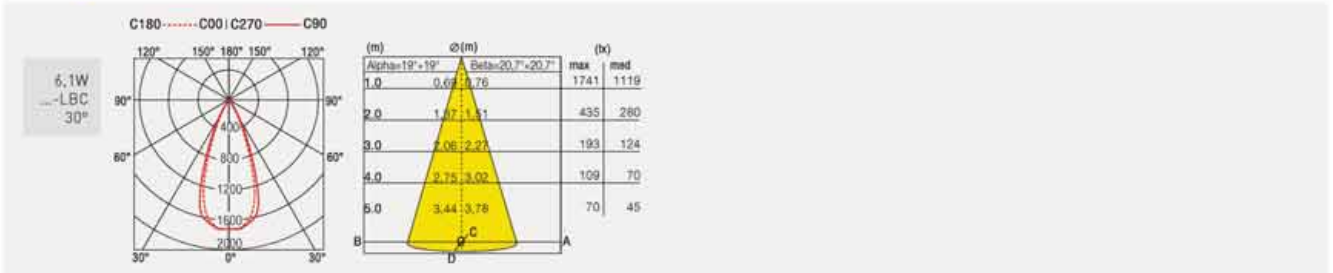

ALIMENTATORI-KIT RGB (se non in dotazione) da ordinare dalla sezione arancio - DRIVERS-RGB KITS (when not supplied) to be ordered from the section orange color



BEND MICRO



- Box e coperchio in acciaio verniciato.
 - Corpo e vano ottico in pressofusione di alluminio verniciato.
 - Alimentatore elettronico.
 - Riflettore in alluminio purissimo, metallizzato in alto vuoto.
 - Led durata utile: 50.000 (h) L90 B50.
 - Consistenza cromatica: 3 SDCM.
- Painted steel box and cap.
 - Housing and optic tray made of powder coated die-cast aluminium.
 - Electronic driver.
 - High purity aluminium reflector, high vacuum metallized.
 - Led life: 50.000 (h) L90 B50.
 - Chromatic consistency: 3 SDCM.

		LED					SYSTEM-SYSTEM			
		W	lm	V	K	CRI	W	lm	lm/W	
		VERSIONE 1 LED - 1 LED VERSION								
		Br 67360-LBC	5,2W	700	220-240V [150mA]	3000	>90	6,2W	595	96
		Ne 67361-LBC								
		Ga 67362-LBC								
		Br 67360-LBN	6,1W	860	220-240V [350mA]	4000	>90	7,1W	561	79
		Ne 67361-LBN								
		Ga 67362-LBN								
		VERSIONE 2 LED - 2 LED VERSION								
		Br 67365-LBC	10,4W	1400	220-240V [150mA]	3000	>90	11,4W	1198	104
		Ne 67366-LBC								
		Ga 67367-LBC								
		Br 67365-LBN	12,2W	1320	220-240V [350mA]	4000	>90	13,2W	1122	85
		Ne 67366-LBN								
		Ga 67367-LBN								
		VERSIONE 3 LED - 3 LED VERSION								
		Br 67370-LBC	15,6W	2100	220-240V [150mA]	3000	>90	17,6W	1785	101
		Ne 67371-LBC								
		Ga 67372-LBC								
		Br 67370-LBN	18,3W	1980	220-240V [350mA]	4000	>90	21,3W	1684	79
		Ne 67371-LBN								
		Ga 67372-LBN								
		VERSIONE 4 LED - 4 LED VERSION								
		Br 67375-LBC	20,8W	2800	220-240V [150mA]	3000	>90	23,8W	2380	100
		Ne 67376-LBC								
		Ga 67377-LBC								
		Br 67375-LBN	24,4W	2640	220-240V [350mA]	4000	>90	27,4W	2245	82
		Ne 67376-LBN								
		Ga 67377-LBN								
		VERSIONE BASETTA TONDA - ROUND BASE VERSION								
		Br 67380-LBC	5,2W	610	220-240V [150mA]	3000	>90	6,2W	595	96
		Ne 67381-LBC								
		Ga 67382-LBC								
		Br 67380-LBN	6,1W	860	220-240V [350mA]	4000	>90	7,1W	561	79
		Ne 67381-LBN								
		Ga 67382-LBN								

ACC. A richiesta - On request: BEND MICRO SLIM per binario 3 fasi - for 3 phase track

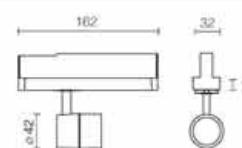

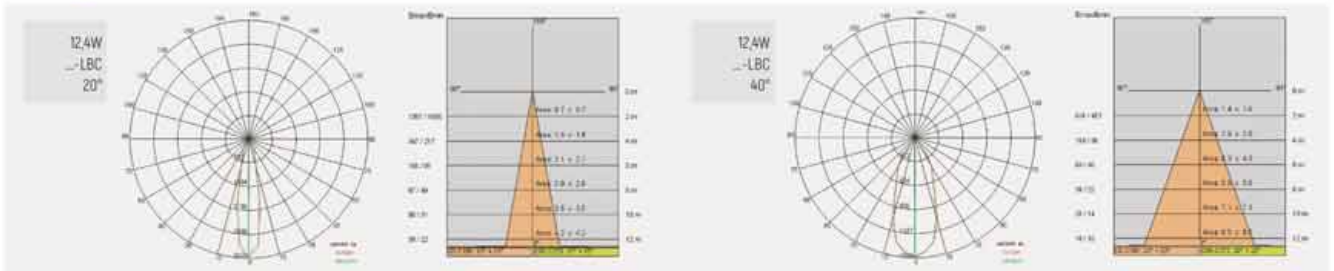
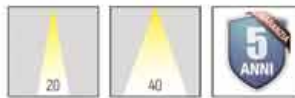

ALIMENTATORI-KIT RGB (se non in dotazione) da ordinare dalla sezione arancio - DRIVERS-RGB KITS (when not supplied) to be ordered from the section orange color



BEND MINI



- Corpo e vano ottico in pressofusione di alluminio verniciato.
- Box e coperchio in acciaio verniciato.
- Alimentatore elettronico.
- Riflettore in policarbonato metallizzato a specchio.
- Led durata utile: 50.000 (h) L80 B20.
- Consistenza cromatica: 3 SDCM.

- Body and optic tray made of powder coated die-cast aluminium.
- Painted steel box and cap.
- Electronic driver.
- Polycarbonate reflector mirrored metallized.
- Led life: 50.000 (h) L80 B20.
- Chromatic consistency: 3 SDCM.

		LED					SISTEMA-SYSTEM					
		W	lm	V	K	CRI	W	lm	lm/W			
	VERSIONE 1 LED - 1 LED VERSION											
	Br	67383-LBC-20	67383-LBC-40									
	Ne	67384-LBC-20	67384-LBC-40	12,4W	1580	220-240V (350mA)	3000	>90	14,4W	1470	97 102	(20°) (40°)
	Gr	67385-LBC-20	67385-LBC-40									
	Br	67383-LBN-20	67383-LBN-40									
	Ne	67384-LBN-20	67384-LBN-40	12,4W	1650	220-240V (350mA)	4000	>90	14,4W	1450	100 107	(20°) (40°)
Gr	67385-LBN-20	67385-LBN-40										
	VERSIONE 2 LED - 2 LED VERSION											
	Br	67386-LBC-20	67386-LBC-40									
	Ne	67387-LBC-20	67387-LBC-40	24,8W	3180	220-240V (350mA)	3000	>90	26,8W	2780	104 110	(20°) (40°)
	Gr	67388-LBC-20	67388-LBC-40									
	Br	67386-LBN-20	67386-LBN-40									
	Ne	67387-LBN-20	67387-LBN-40	24,8W	3300	220-240V (350mA)	4000	>90	26,8W	2900	108 114	(20°) (40°)
Gr	67388-LBN-20	67388-LBN-40										
	VERSIONE 3 LED - 3 LED VERSION											
	Br	67389-LBC-20	67389-LBC-40									
	Ne	67390-LBC-20	67390-LBC-40	37,2W	4740	220-240V (350mA)	3000	>90	39,2W	4170	106 112	(20°) (40°)
	Gr	67391-LBC-20	67391-LBC-40									
	Br	67389-LBN-20	67389-LBN-40									
	Ne	67390-LBN-20	67390-LBN-40	37,2W	4950	220-240V (350mA)	4000	>90	39,2W	4355	111 117	(20°) (40°)
Gr	67391-LBN-20	67391-LBN-40										
	VERSIONE 4 LED - 4 LED VERSION											
	Br	67392-LBC-20	67392-LBC-40									
	Ne	67393-LBC-20	67393-LBC-40	49,6W	6320	220-240V (350mA)	3000	>90	51,6W	5560	107 114	(20°) (40°)
	Gr	67394-LBC-20	67394-LBC-40									
	Br	67392-LBN-20	67392-LBN-40									
	Ne	67393-LBN-20	67393-LBN-40	49,6W	6600	220-240V (350mA)	4000	>90	51,6W	5800	112 118	(20°) (40°)
Gr	67394-LBN-20	67394-LBN-40										





PARETE - PLAFONE - SOSPENSIONE
WALL - CEILING - SUSPENSION

• DECO-TECH



SINDI PLAFONE

195



CUBIK

198



MATRIX RANGE

205



DROP

206



SWING PLAFONE

214



NET RANGE
MCL

216



VEGA XS-XL
PARETE

219



SOLARIS

221



BIG
PLAFONE

228



BIG
SOSPENSIONE

234



BIG FLAT
PLAFONE

243



BIG FLAT
SOSPENSIONE

247



STARGATE

251



STARGATE
2000/3000

258



AURORA XS

261



AURORA XL

263



QUADRANT

265

• FUNZIONALI – FUNCTIONAL



MINI TOWER
MCL

266



NET RANGE
15 MCL

268



NET RANGE
18 MCL

270



ROSS
PARETE

273



ROSS
SOSPENSIONE

275



SD-HIGHBAY

277

• LINEARI – LINEAR



ELISEO
PARETE

279



ELISEO
SOSPENSIONE

280



SLIM LED

283



TAPE

285



STRIP LED

290



SINDI 60 PLAFONE



- Corpo in pressofusione di alluminio.
- Verniciatura in polveri di poliestere.
- Schermo di protezione in policarbonato.
- Led durata utile: 50.000 (h) L80 B10.
- Body made of die-cast aluminum.
- Polyester powder painting.
- Polycarbonate protection screen.
- Led life: 50.000 (h) L80 B10.

		LED					SISTEMA-SYSTEM		
		W	lm	V	K	CRI	W	lm	lm/W
	Br 2868-LBC-P	9W	1000	220-240V (250mA)	3000	>90	10W	440	44
	Ne 2869-LBC-P								
	Gr 2870-LBC-P								
	Br 2868-LBN-P	9W	1060	220-240V (250mA)	4000	>90	10W	467	47
	Ne 2869-LBN-P								
	Gr 2870-LBN-P								

OP. A richiesta - On request: Led con temperatura di COLORE 2700K - Temperature LED COLOUR 2700K

versioni DALI disponibile con alimentatore remoto - available version DALI with remote driver

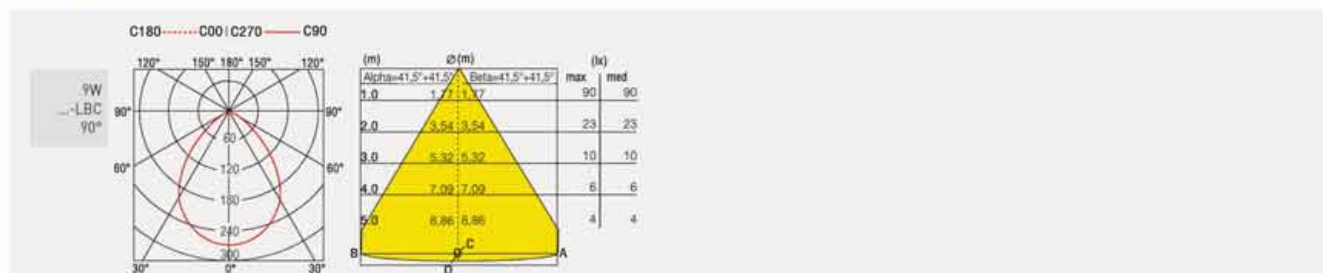

ALIMENTATORI-KIT RGB (se non in dotazione) da ordinare dalla sezione arancio - DRIVERS-RGB KITS (when not supplied) to be ordered from the section orange color

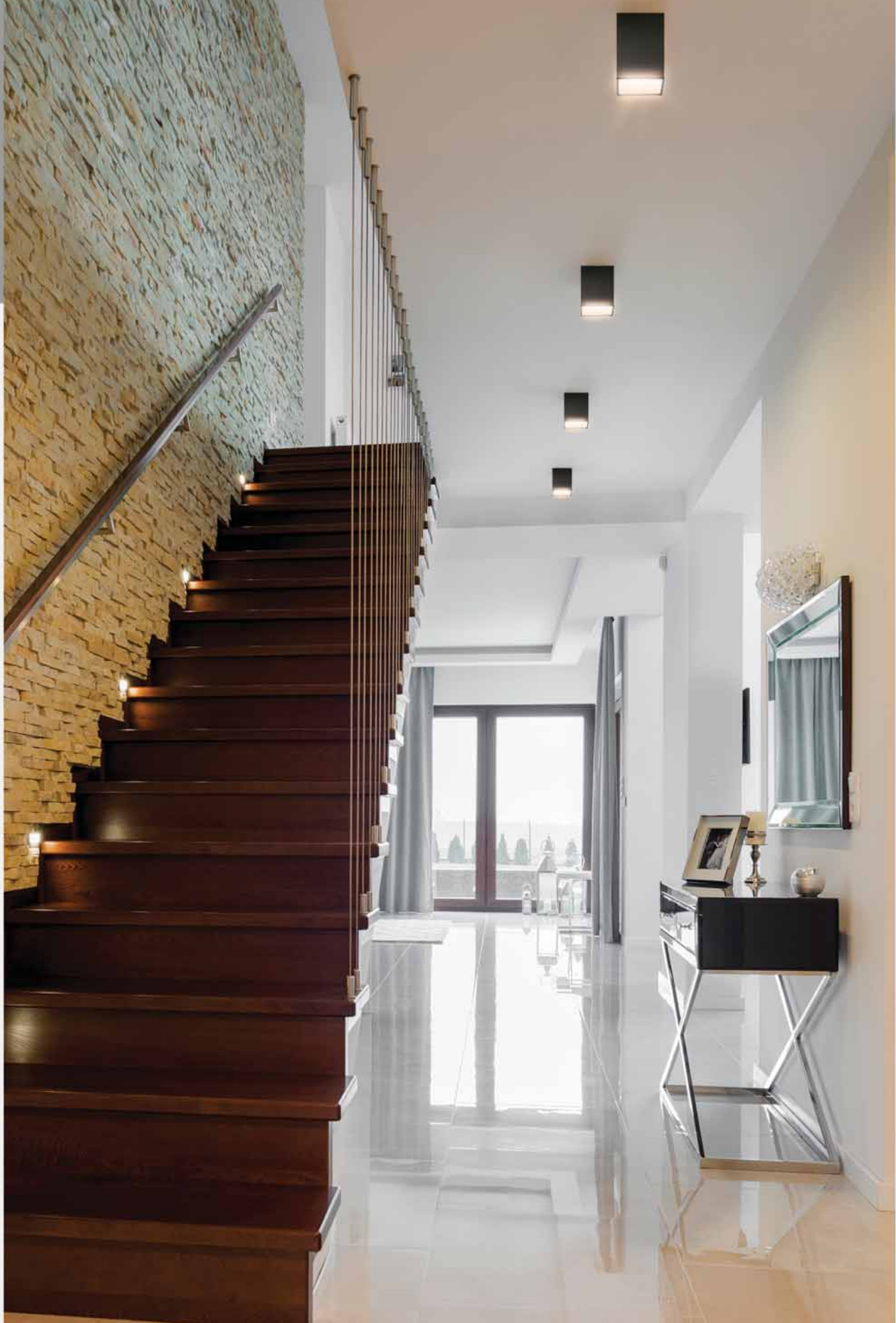



- Corpo in pressofusione di alluminio.
- Verniciatura in polveri di poliestere.
- Schermo di protezione in policarbonato.
- Led durata utile: 50.000 (h) L90 B20.
- Body made of die-cast aluminum.
- Polyester powder painting.
- Polycarbonate protection screen.
- Led life: 50.000 (h) L90 B20.

SINDI 100 PLAFONE



	Br	Ne	Gr	LED					SISTEMA-SYSTEM		
				W	lm	V	K	CRI	W	lm	W
	2860-LBC-P	2861-LBC-P	2862-LBC-P	11,5W	1840	220-240V (350mA)	3000	>90	13,5W	1141	85
	2860-LBN-P	2861-LBN-P	2862-LBN-P	11,5W	1950	220-240 (350mA)	4000	>90	13,5W	1209	90

OP: A richiesta - On request: Led con temperatura di COLORE 2700K - Temperature Led COLOUR 2700K

versioni DALI disponibile con alimentatore remoto - available version DALI with remote driver



inside outside

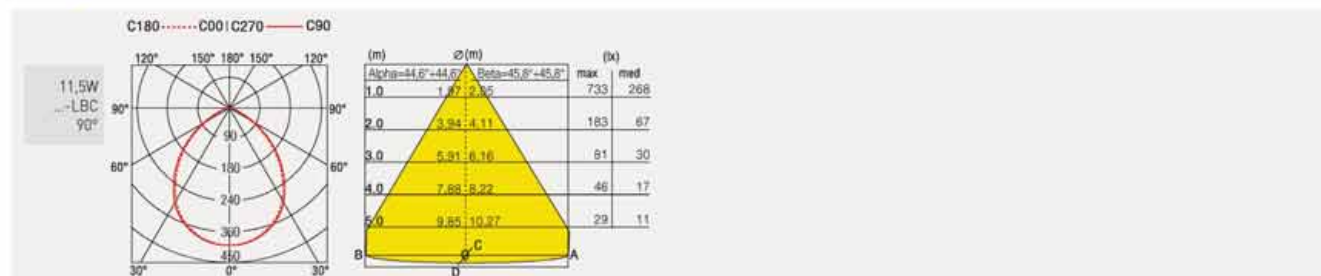

ALIMENTATORI-KIT RGB (se non in dotazione) da ordinare dalla sezione arancio - DRIVERS-RGB KITS (when not supplied) to be ordered from the section orange color

CUBIK

- Corpo in estruso di alluminio.
- Verniciatura in polveri di poliestere.
- Piastra di aggancio a soffitto in lamiera verniciata.
- Trittico Led.

- Body made of extruded aluminium.
- Polyester powder painting.
- Ceiling fixing plate made of painted metal sheet.
- Triptych led module.

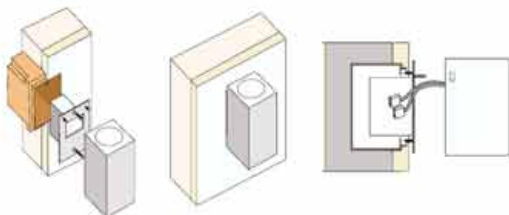

Schema di montaggio a parete per versione biemissione [scatola elettrica tipo 503 in dotazione con l'apparecchio].
Wall fixing scheme for biemission version [electrical box type 503 supplied with the fitting].

			LED					SISTEMI-SYSTEM			
			W	lm	V	K	CRI	W	lm	IP	
PARETE MONO EMISSIONE - WALL MONO EMISSION											
Bi	57171-LBC-10	57171-LBC-30	57171-LBC-45								
Ne	57172-LBC-10	57172-LBC-30	57172-LBC-45	3x1,2W	240	220-240V [350mA]	3000	>90	4,6W	240	60
Ga	57173-LBC-10	57173-LBC-30	57173-LBC-45								
PARETE MONO EMISSIONE - WALL MONO EMISSION											
Bi	57171-LBI-10	57171-LBI-30	57171-LBI-45								
Ne	57172-LBI-10	57172-LBI-30	57172-LBI-45	3x1,2W	300	220-240V [350mA]	4000	>90	4,6W	300	35
Ga	57173-LBI-10	57173-LBI-30	57173-LBI-45								



			LED					SISTEMI-SYSTEM			
			W	lm	V	K	CRI	W	lm	IP	
PARETE DOPPIA EMISSIONE - WALL DOUBLE EMISSION											
Bi	57174-LBC-10	57174-LBC-30	57174-LBC-45	6x1,2W	2x240	220-240V [350mA]	3000	>90	8,2W	480	59
Ne	57175-LBC-10	57175-LBC-30	57175-LBC-45								
Ga	57176-LBC-10	57176-LBC-30	57176-LBC-45								
PARETE DOPPIA EMISSIONE - WALL DOUBLE EMISSION											
Bi	57174-LBI-10	57174-LBI-30	57174-LBI-45								
Ne	57175-LBI-10	57175-LBI-30	57175-LBI-45	6x1,2W	2x300	220-240V [350mA]	6000	>90	8,2W	600	73
Ga	57176-LBI-10	57176-LBI-30	57176-LBI-45								

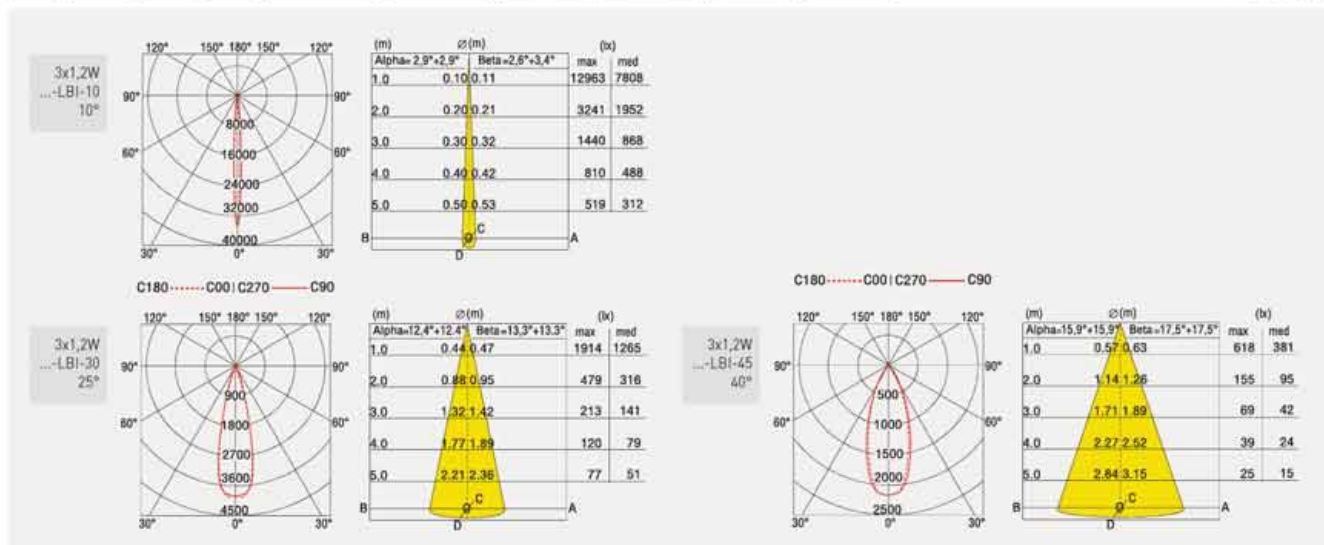
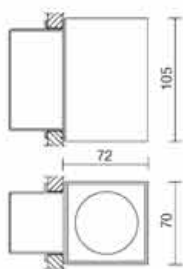



- Corpo in estruso di alluminio.
- Verniciatura in polveri di poliestere.
- Piastra di aggancio a soffitto in lamiera verniciata.
- Trittico Led.

- Body made of extruded aluminium.
- Polyester powder painting.
- Ceiling fixing plate made of painted metal sheet.
- Triptych led module.



	PLAFONE - CEILING	LEO			SISTEMA-SYSTEM						
		W	lm	V	K	CR1	W	lm	lm		
	Bi 57168-LBC-10	57168-LBC-30	57168-LBC-45	3x1,2W	240	220-240V [350mA]	3000	>90	4,6W	240	52
	Ne 57169-LBC-10	57169-LBC-30	57169-LBC-45								
	Ga 57170-LBC-10	57170-LBC-30	57170-LBC-45								
	Bi 57168-LBI-10	57168-LBI-30	57168-LBI-45	3x1,2W	300	220-240V [350mA]	6000	>90	4,6W	300	65
	Ne 57169-LBI-10	57169-LBI-30	57169-LBI-45								
	Ga 57170-LBI-10	57170-LBI-30	57170-LBI-45								

	SOSPENSIONE - SUSPENSION	LEO			SISTEMA-SYSTEM						
		W	lm	V	K	CR1	W	lm	lm		
	Bi 57165-LBC-10	57165-LBC-30	57165-LBC-45	3x1,2W	240	220-240V [350mA]	3000	>90	4,6W	240	52
	Ne 57166-LBC-10	57166-LBC-30	57166-LBC-45								
	Ga 57167-LBC-10	57167-LBC-30	57167-LBC-45								
	Bi 57165-LBI-10	57165-LBI-30	57165-LBI-45	3x1,2W	300	220-240V [350mA]	4000	>90	4,6W	300	65
	Ne 57166-LBI-10	57166-LBI-30	57166-LBI-45								
	Ga 57167-LBI-10	57167-LBI-30	57167-LBI-45								

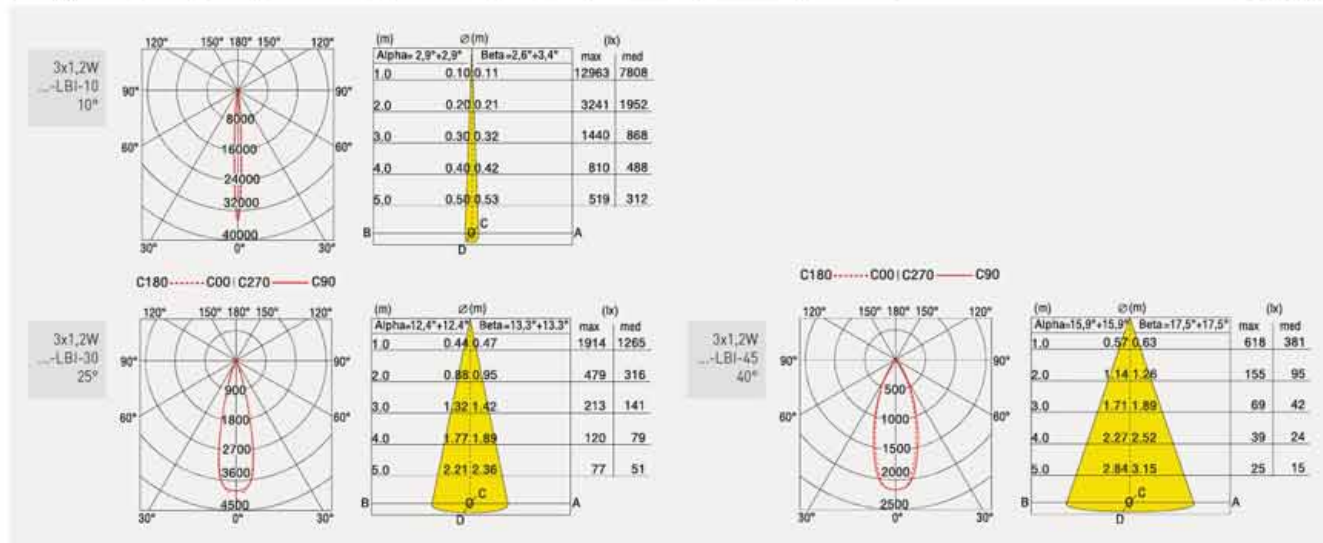

ALIMENTATORI-KIT RGB (se non in dotazione) da ordinare dalla sezione arancio - DRIVERS-RGB KITS (when not supplied) to be ordered from the section orange color

CUBIK

- Corpo in estruso di alluminio.
- Verniciatura in polveri di poliestere.
- Piastra di aggancio a soffitto in lamiera verniciata.
- Lampada integrata GU 10, Led 230V, tensione di rete.
- Fasci: 36°/60° per LBC-LBN.
45° per RGBW.

- Body made of extruded aluminium.
- Polyester powder painting.
- Ceiling fixing plate made of painted metal sheet.
- Integrated lamp GU10 LED 230V mains voltage.
- Beam: 36°/60° for LBC-LBN
45° for RGBW



					(W)	(lm)	(V)		(K)	(CRI)
	PARETE MONO EMISSIONE - WALL MONO EMISSION									
	Bi	57171-LBC-36	57171-LBC-60							
	Ne	57172-LBC-36	57172-LBC-60		4,9W	365	220-240V		3000	>90
	Ga	57173-LBC-36	57173-LBC-60							
	PARETE MONO EMISSIONE - WALL MONO EMISSION									
	Bi	57171-LBN-36	57171-LBN-60							
	Ne	57172-LBN-36	57172-LBN-60		4,9W	380	220-240V		4000	>90
	Ga	57173-LBN-36	57173-LBN-60							
	PARETE MONO EMISSIONE - WALL MONO EMISSION									
	Bi		57171-RGBW-45							
	Ne		57172-RGBW-45		5W	350	220-240V			>80
	Ga		57173-RGBW-45							
GU 10										
	PARETE DOPPIA EMISSIONE - WALL DOUBLE EMISSION									
	Bi	57174-LBC-36	57174-LBC-60							
	Ne	57175-LBC-36	57175-LBC-60		2x4,9W	2X365	220-240V		3000	>90
	Ga	57176-LBC-36	57176-LBC-60							
	PARETE DOPPIA EMISSIONE - WALL DOUBLE EMISSION									
	Bi	57174-LBN-36	57174-LBN-60							
	Ne	57175-LBN-36	57175-LBN-60		2x4,9W	2X380	220-240V		4000	>90
	Ga	57176-LBN-36	57176-LBN-60							
	PARETE DOPPIA EMISSIONE - WALL DOUBLE EMISSION									
	Bi		57174-RGBW-45							
	Ne		57175-RGBW-45		2x5W	2X350	220-240V			>80
	Ga		57176-RGBW-45							



ALIMENTATORI-KIT RGB (se non in dotazione) da ordinare dalla sezione arancio - DRIVERS-RGB KITS (when not supplied) to be ordered from the section orange color

CUBIK



- Corpo in estruso di alluminio.
- Verniciatura in polveri di poliestere.
- Piastra di aggancio a soffitto in lamiera verniciata.
- Lampada integrata GU 10, Led 230V, tensione di rete.
- Fasci: 36°/60° per LBC-LBN.
45° per RGBW.

- Body made of extruded aluminium.
- Polyester powder painting.
- Ceiling fixing plate made of painted metal sheet.
- Integrated lamp GU10 LED 230V mains voltage.
- Beam: 36°/60° for LBC-LBN
45° for RGBW



PLAFONE - CEILING										
Bi	57168-LBC-36	57168-LBC-60			4,9W	365	220-240V		3000	>90
Ne	57169-LBC-36	57169-LBC-60								
Ga	57170-LBC-36	57170-LBC-60								
<hr/>										
Bi	57168-LBN-36	57168-LBN-60								
Ne	57169-LBN-36	57169-LBN-60			4,9W	380	220-240V		4000	>90
Ga	57170-LBN-36	57170-LBN-60								
<hr/>										
Bi		57168-RGBW-45								
Ne		57169-RGBW-45			5W	350	220-240V			>80
Ga		57170-RGBW-45								

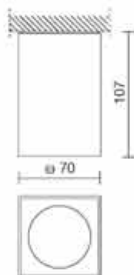

SOSPENSIONE - SUSPENSION										
Bi	57165-LBC-36	57165-LBC-60			4,9W	365	220-240V		3000	>90
Ne	57166-LBC-36	57166-LBC-60								
Ga	57167-LBC-36	57167-LBC-60								
<hr/>										
Bi	57165-LBN-36	57165-LBN-60								
Ne	57166-LBN-36	57166-LBN-60			4,9W	380	220-240V		4000	>90
Ga	57167-LBN-36	57167-LBN-60								
<hr/>										
Bi		57165-RGBW-45								
Ne		57166-RGBW-45			5W	350	220-240V			>80
Ga		57167-RGBW-45								

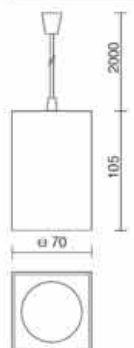

IP 40

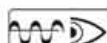

inside

ALIMENTATORI-KIT RGB (se non in dotazione) da ordinare dalla sezione arancio - DRIVERS-RGB KITS (when not supplied) to be ordered from the section orange color



CUBIK

- Corpo in estruso di alluminio.
- Verniciatura in polveri di poliestere.
- Piastra di aggancio a soffitto in lamiera verniciata.
- Lampada PL-CH 50-COB e driver integrato.

- Body made of extruded aluminium.
- Polyester powder painting.
- Ceiling fixing plate made of painted metal sheet.
- PL-CH 50-COB lamp and integrated driver.



				LED					SISTEMA-SYSTEM			
				W	lm	V	K	°	CRI	W	lm	IP
PARETE MONO EMISSIONE - WALL MONO EMISSION												
Bi	57171C-LBC-15	57171C-LBC-24	57171C-LBC-40		590					580	71	
Ne	57172C-LBC-15	57172C-LBC-24	57172C-LBC-40	7,2W	800	220-240V (200mA)	3000		>90	8,2W	590	72
Ga	57173C-LBC-15	57173C-LBC-24	57173C-LBC-40		800					590	72	
Bi	57171C-LBN-15	57171C-LBN-24	57171C-LBN-40		645					635	77	
Ne	57172C-LBN-15	57172C-LBN-24	57172C-LBN-40	7,2W	630	220-240V (200mA)	4000		>90	8,2W	620	76
Ga	57173C-LBN-15	57173C-LBN-24	57173C-LBN-40		630					620	76	

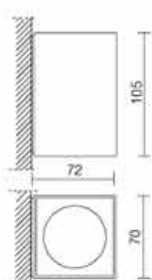

				LED					SISTEMA-SYSTEM			
				W	lm	V	K	°	CRI	W	lm	IP
PARETE DOPPIA EMISSIONE - WALL DOUBLE EMISSION												
Bi	57174C-LBC-15	57174C-LBC-24	57174C-LBC-40		442					884	74	
Ne	57175C-LBC-15	57175C-LBC-24	57175C-LBC-40	2x5,4W	450	220-240V (150mA)	3000		>90	12W	900	75
Ga	57176C-LBC-15	57176C-LBC-24	57176C-LBC-40		450					900	75	
Bi	57174C-LBN-15	57174C-LBN-24	57174C-LBN-40		483					966	80	
Ne	57175C-LBN-15	57175C-LBN-24	57175C-LBN-40	2x5,4W	471	220-240V (150mA)	4000		>90	12W	942	78
Ga	57176C-LBN-15	57176C-LBN-24	57176C-LBN-40		471					942	78	

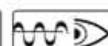
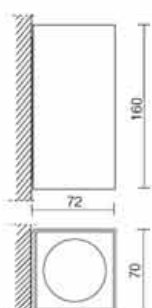



- Corpo in estruso di alluminio.
- Verniciatura in polveri di poliestere.
- Piastra di aggancio a soffitto in lamiera verniciata.
- Lampada PL-CH 50-COB e driver integrato.

- Body made of extruded aluminium.
- Polyester powder painting.
- Ceiling fixing plate made of painted metal sheet.
- PL-CH 50-COB lamp and integrated driver.



	15	24	40	LED					SYSTEM-SYSTEM			
				W	lm	V	K	°	CR1	W	lm	lm/W
PLAFONE - CEILING												
Bi	57168C-LBC-15	57168C-LBC-24	57168C-LBC-40		590						580	71
Ne	57169C-LBC-15	57169C-LBC-24	57169C-LBC-40	7,2W	600	220-240V (200mA)	3000				590	72
Ga	57170C-LBC-15	57170C-LBC-24	57170C-LBC-40		600						590	72
Bi	57168C-LBN-15	57168C-LBN-24	57168C-LBN-40		645						635	77
Ne	57169C-LBN-15	57169C-LBN-24	57169C-LBN-40	7,2W	630	220-240V (200mA)	4000				620	76
Ga	57170C-LBN-15	57170C-LBN-24	57170C-LBN-40		630						620	76

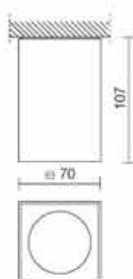

	15	24	40	LED					SYSTEM-SYSTEM			
				W	lm	V	K	°	CR1	W	lm	lm/W
SOSPENSIONE - SUSPENSION												
Bi	57165C-LBC-15	57165C-LBC-24	57165C-LBC-40		590						580	71
Ne	57166C-LBC-15	57166C-LBC-24	57166C-LBC-40	7,2W	600	220-240V (200mA)	3000				590	72
Ga	57167C-LBC-15	57167C-LBC-24	57167C-LBC-40		600						590	72
Bi	57165C-LBN-15	57165C-LBN-24	57165C-LBN-40		645						635	77
Ne	57166C-LBN-15	57166C-LBN-24	57166C-LBN-40	7,2W	630	220-240V (200mA)	4000				620	76
Ga	57167C-LBN-15	57167C-LBN-24	57167C-LBN-40		630						620	76

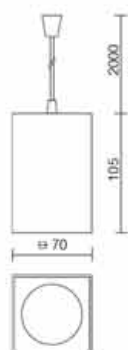

ALIMENTATORI-KIT RGB (se non in dotazione) da ordinare dalla sezione arancio - DRIVERS-RGB KITS (when not supplied) to be ordered from the section orange color



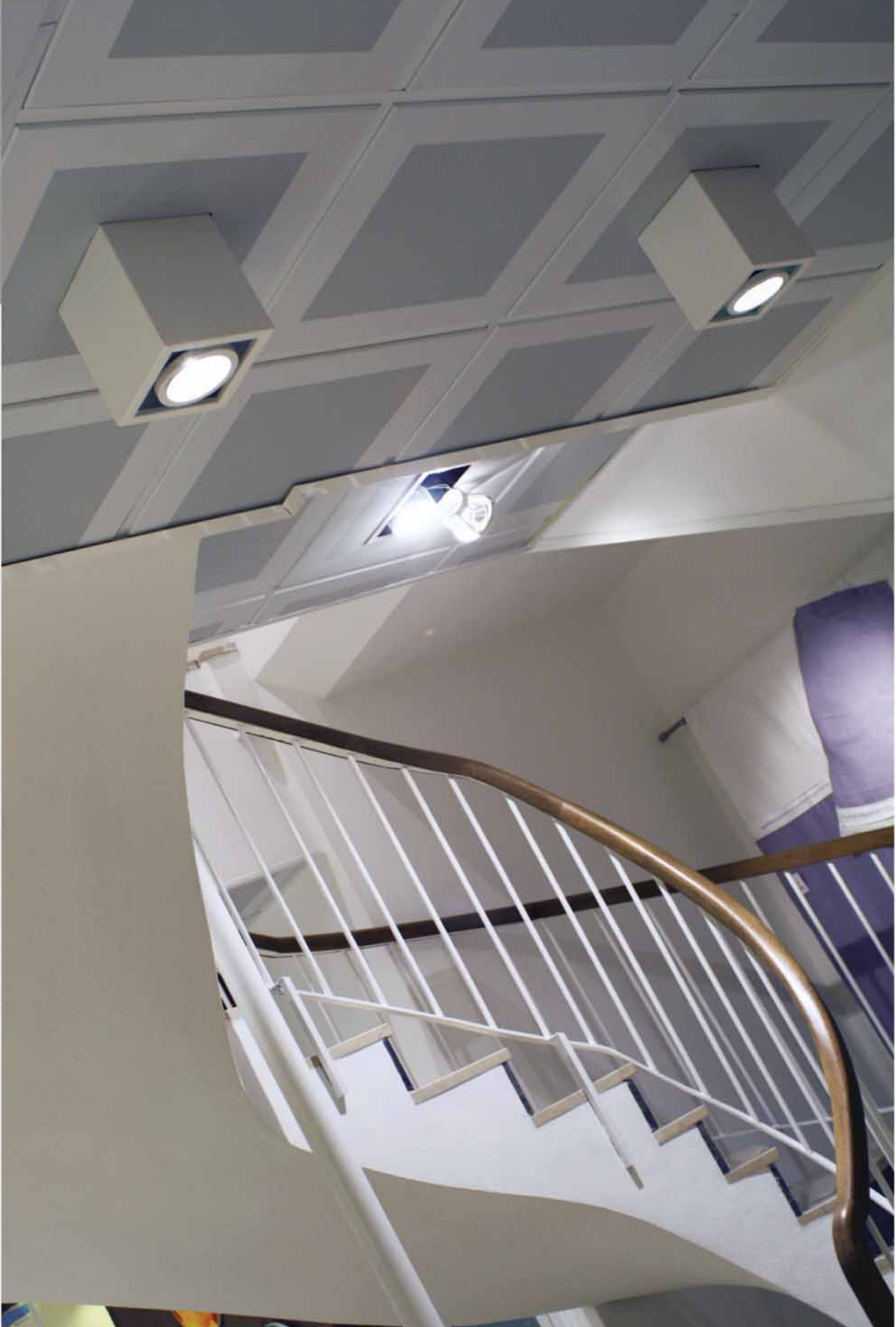

MATRIX RANGE



- Corpo, staffe e cornice in metallo verniciato.
- Verniciatura in polveri di poliestere.
- Ghiera in alluminio pressofuso.
- Gruppo ottico orientabile.

- Housing, bracket and frame of painted metal.
- Polyester powder painting.
- Trim of die-cast aluminium.
- Adjustable optics.

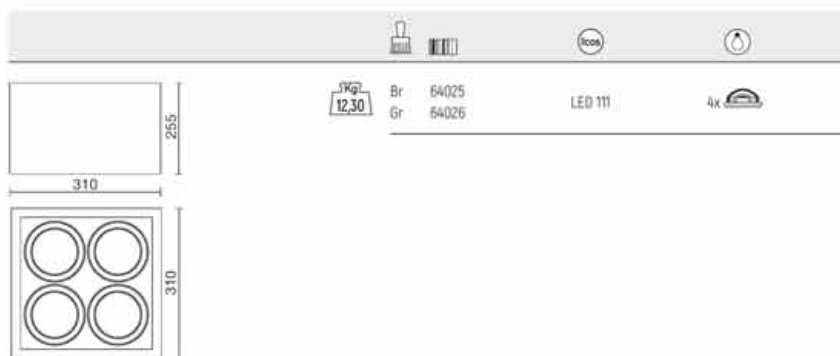
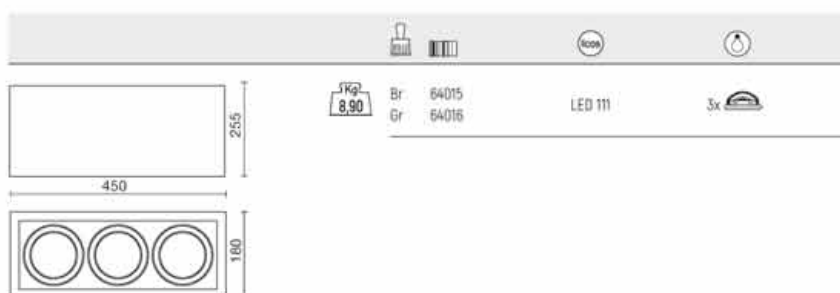
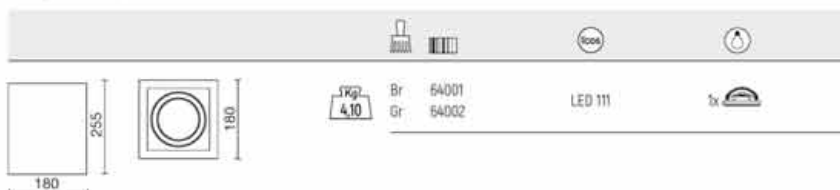

L'apparecchio non è munito di alimentatore e di lampade LED 111 che potranno essere ordinate a SIDE a seconda del tipo di fascio e di potenza desiderata.
The fitting is not equipped with a driver and LED 111 lamps which can be ordered to SIDE depending on the type of beam and the required power.

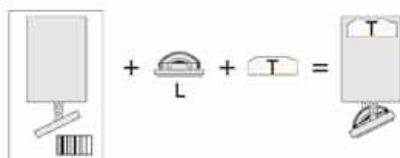

L LAMPADE LED CONSIGLIATE - RECOMMENDED LED LAMPS

646339-930	26W	700mA	3000K
646347-930	37W	1050mA	3000K



T ALIMENTATORI CONSIGLIATI - RECOMMENDED DRIVERS

646349-I	30W
646168-I	40W



ALIMENTATORI-KIT RGB (se non in dotazione) da ordinare dalla sezione arancio - DRIVERS-RGB KITS (when not supplied) to be ordered from the section orange color



DROP 30 XS - M - XL

- Corpo in alluminio estruso, lunghezza 300 mm.
 - Verniciatura in polveri di poliestere.
 - Gruppo di alimentazione integrato.
 - Led durata utile: 50.000 (h) L80 B20.
- Body made of extruded aluminium, length 300 mm.
 - Polyester powder painting.
 - Built-in power supply unit.
 - Led life: 50.000 (h) L80 B20.



DROP 30 XS	LED	SISTEMA-SYSTEM		
		W	lm	lm/W
 Br D2210-LBC Ne D2211-LBC Ga D2212-LBC 0,38kg	3,5W 350	220-240V [350mA]	3000 >90	4,5W 266 59
	3,5W 380	220-240V [350mA]	4000 >90	4,5W 279 62

DROP 30 M	LED	SISTEMA-SYSTEM		
		W	lm	lm/W
 VERSIONE LAMPADA COIN - COIN LAMP VERSION Br D2216-MLBC-25 D2216-MLBC-40 Ne D2217-MLBC-25 D2217-MLBC-40 Ga D2218-MLBC-25 D2218-MLBC-40 0,68kg	7,3W 817	220-240V [200mA]	3000 >90	8,3W 817 98 (25°) 94 (40°)
	7,3W 862	220-240V [200mA]	4000 >90	8,3W 862 104 (25°) 96 (40°)

DROP 30 XL	LED	SISTEMA-SYSTEM		
		W	lm	lm/W
 Br D2234-LBC-15 D2234-LBC-25 D2234-LBC-40 Ne D2235-LBC-15 D2235-LBC-25 D2235-LBC-40 Ga D2236-LBC-15 D2236-LBC-25 D2236-LBC-40 1,37kg	17W 2500	220-240V [500mA]	3000 >90	20W 2122 106 (15°) 2039 102 (25°) 2141 107 (40°)
	17W 2665	220-240V [500mA]	4000 >90	20W 2248 112 (15°) 2322 116 (25°) 2298 115 (40°)

OP. A richiesta - On request: Led con temperatura di COLORE 2700K - Temperature LED COLOUR 2700K

OP. A richiesta - On request: Finitura Bronzo e Oro - Bronze and Gold finishing

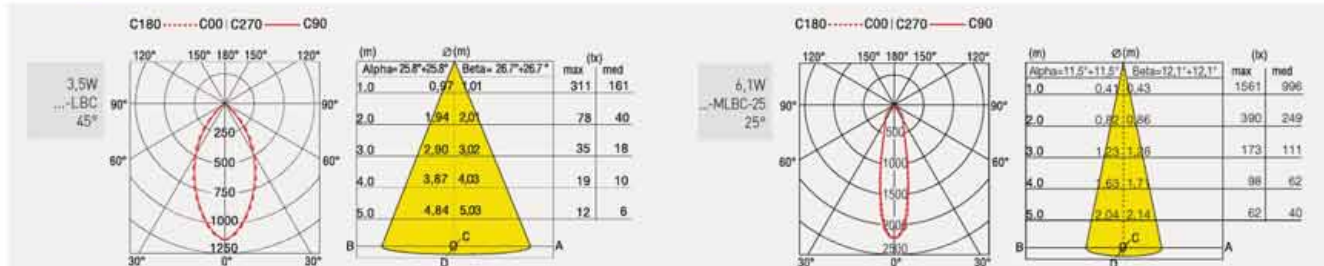

ALIMENTATORI-KIT RGB (se non in dotazione) da ordinare dalla sezione arancio - DRIVERS-RGB KITS (when not supplied) to be ordered from the section orange color



DROP 60 XS - M - XL



- Corpo in alluminio estruso, lunghezza 600 mm.
- Verniciatura in polveri di poliestere.
- Gruppo di alimentazione integrato.
- Led durata utile: 50.000 (h) L90 B20.

- Body made of extruded aluminium, length 600 mm.
- Polyester powder painting.
- Built-in power supply unit.
- Led life: 50.000 (h) L90 B20.

DROP 60 XS	Br D2213-LBC Ne D2214-LBC Ga D2215-LBC	Kg 0,70	LED					SISTEMA-SYSTEM		
			W	lm	V	K	CRI	W	lm	lm/W
	Br D2213-LBN Ne D2214-LBN Ga D2215-LBN	Kg 0,70	3,5W	350	220-240V (350mA)	3000	>90	4,5W	266	59
	3,5W		380	220-240V (350mA)	4000	>90	4,5W	279	62	

DROP 60 M	Br D2225-MLBC-25 Ne D2226-MLBC-25 Ga D2227-MLBC-25	Kg 1,15	LED					SISTEMA-SYSTEM			
			W	lm	V	K	CRI	W	lm	lm/W	
	Br D2225-MLBN-25 Ne D2226-MLBN-25 Ga D2227-MLBN-25	Kg 1,15	7,3W	817	220-240V (200mA)	3000	>90	8,3W	817	98	(25°)
	7,3W		777	220-240V (200mA)	4000	>90	8,3W	777	94	(40°)	
	Br D2225-MLBN-40 Ne D2226-MLBN-40 Ga D2227-MLBN-40		7,3W	862	220-240V (200mA)	4000	>90	8,3W	862	104	(25°)
				817				8,3W	817	98	(40°)

DROP 60 XL	Br D2237-LBC-15 Ne D2238-LBC-15 Ga D2239-LBC-15	Kg 2,00	LED					SISTEMA-SYSTEM			
			W	lm	V	K	CRI	W	lm	lm/W	
	Br D2237-LBN-15 Ne D2238-LBN-15 Ga D2239-LBN-15	Kg 2,00	17W	2500	220-240V (500mA)	3000	>90	20W	2122	106	(15°)
	17W		2665	220-240V (500mA)	4000	>90	20W	2039	102	(25°)	
								2141	107	(40°)	
								2248	112	(15°)	
								2322	116	(25°)	
								2298	115	(40°)	

OP. A richiesta - On request: Led con temperatura di COLORE 2700K - Temperature LED COLOUR 2700K

OP. A richiesta - On request: Finitura Bronzo e Oro - Bronze and Gold finishing

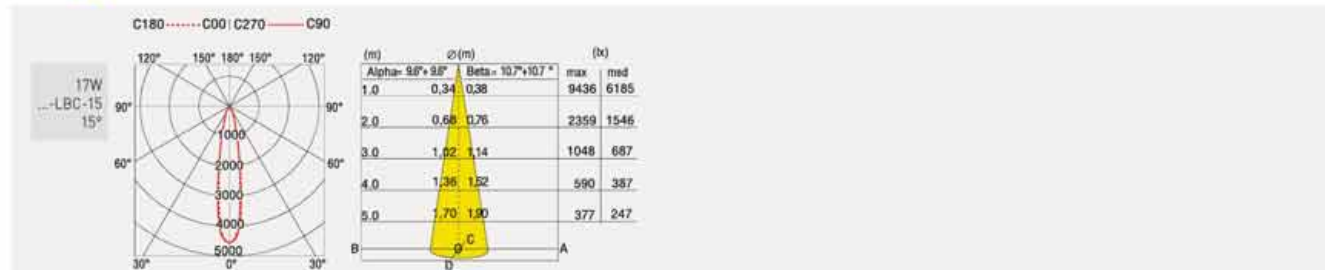

ALIMENTATORI-KIT RGB (se non in dotazione) da ordinare dalla sezione arancio - DRIVERS-RGB KITS (when not supplied) to be ordered from the section orange color

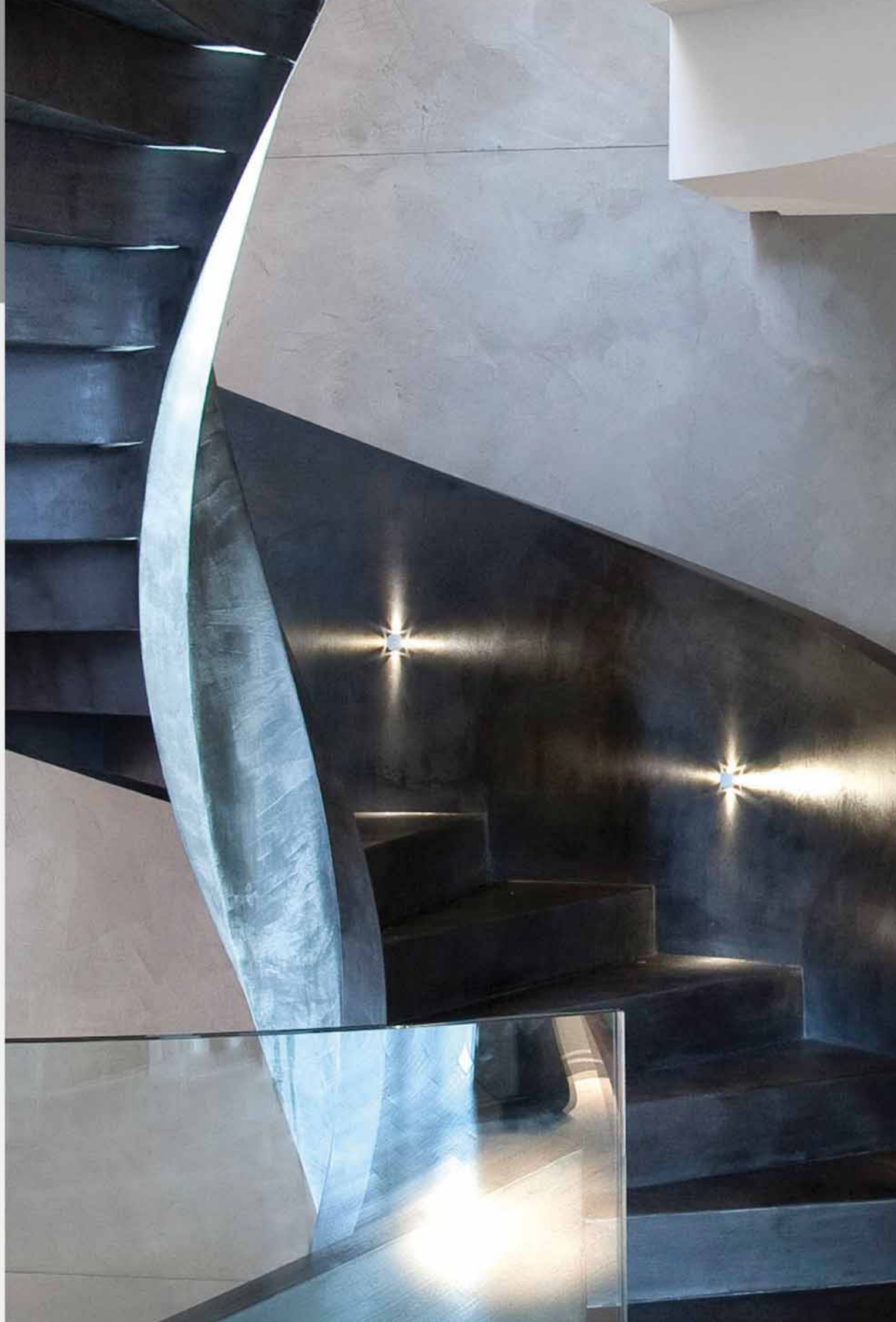

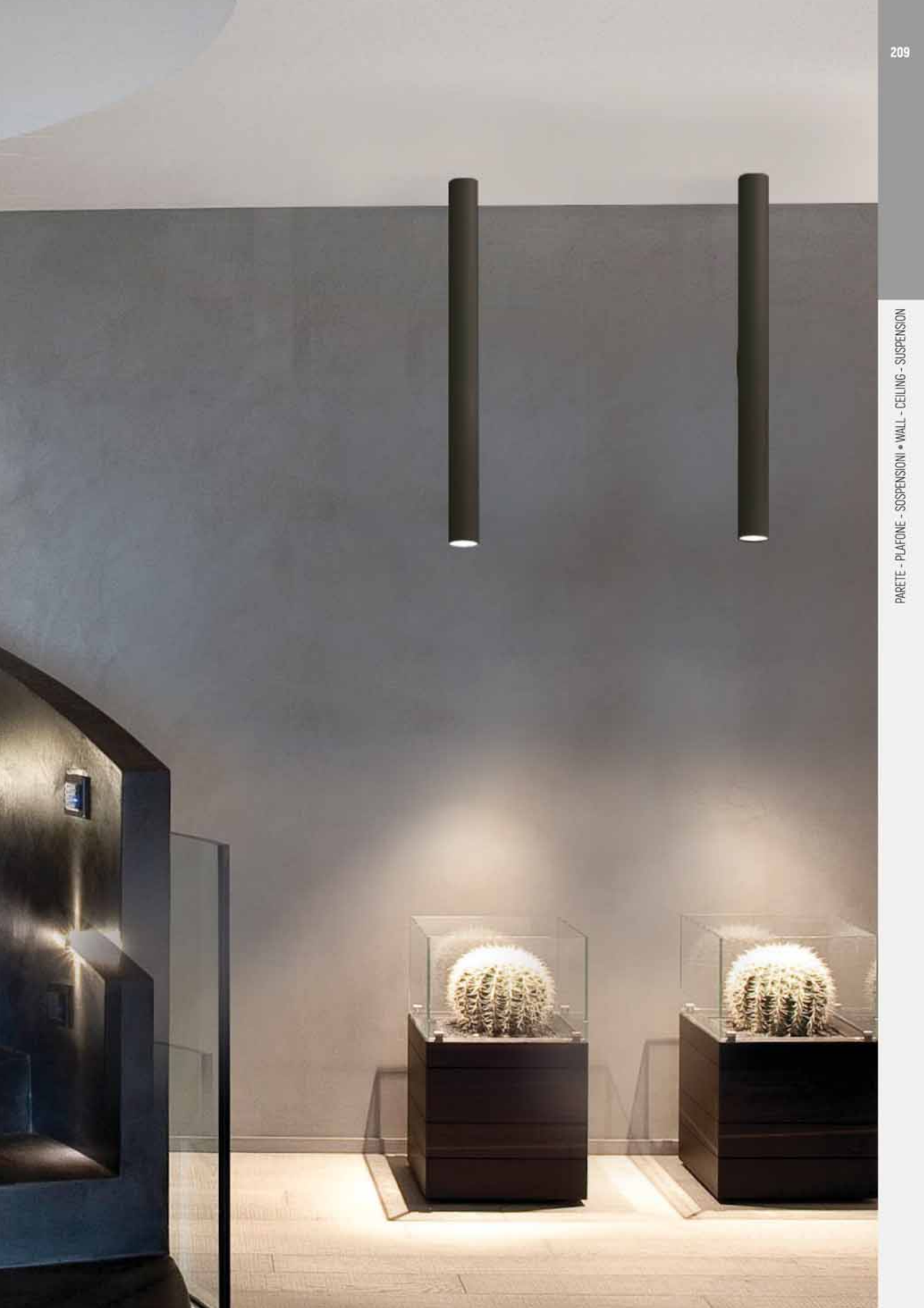





DROP 30S XS - M - XL



- Corpo in alluminio estruso, lunghezza 300 mm.
- Verniciatura in polveri di poliestere.
- Gruppo di alimentazione integrato.
- Kit di sospensione con cavo di alimentazione lunghezza 2 m, e rosone.
- Led durata utile: 50.000 (h) L90 B20.

- Main body made of extruded aluminium, length 300 mm.
- Polyester powder painting.
- Built-in power supply unit.
- Complete with canopy and suspension cable, length 2 m.
- Led life: 50.000 (h) L90 B20.

DROP 30S XS		LED					SISTEMA-SYSTEM		
		W	lm	V	K	CRI	W	lm	W
Br D2210-LBC-S		3,5W	350	220-240V [350mA]	3000	>90	4,5W	266	59
Ne D2211-LBC-S									
Ga D2212-LBC-S									
Br D2210-LBN-S		3,5W	380	220-240V [350mA]	4000	>90	4,5W	279	62
Ne D2211-LBN-S									
Ga D2212-LBN-S									

DROP 30S M		LED					SISTEMA-SYSTEM			
		W	lm	V	K	CRI	W	lm	W	°
Br D2216-MLBC25S		7,3W	817	220-240V [200mA]	3000	>90	8,3W	817	98	[25°]
Ne D2217-MLBC25S										
Ga D2218-MLBC25S										
Br D2216-MLBN25S		7,3W	862	220-240V [200mA]	4000	>90	8,3W	862	104	[25°]
Ne D2217-MLBN25S										
Ga D2218-MLBN25S										

DROP 30S XL		LED					SISTEMA-SYSTEM			
		W	lm	V	K	CRI	W	lm	W	°
Br D2234-LBC-15S		17W	2500	220-240V 500mA]	3000	>90	20W	2122	108	[15°]
Ne D2235-LBC-15S										
Ga D2236-LBC-15S										
Br D2234-LBN-15S		17W	2665	220-240V [500mA]	4000	>90	20W	2248	112	[15°]
Ne D2235-LBN-15S										
Ga D2236-LBN-15S										

OP. A richiesta - On request: Led con temperatura di COLORE 2700K - Temperature LED COLOUR 2700K

OP. A richiesta - On request: Adattatore per binario SITRACK - SITRACK adaptor
Finitura Bronzo e Oro - Bronze and Gold finishing

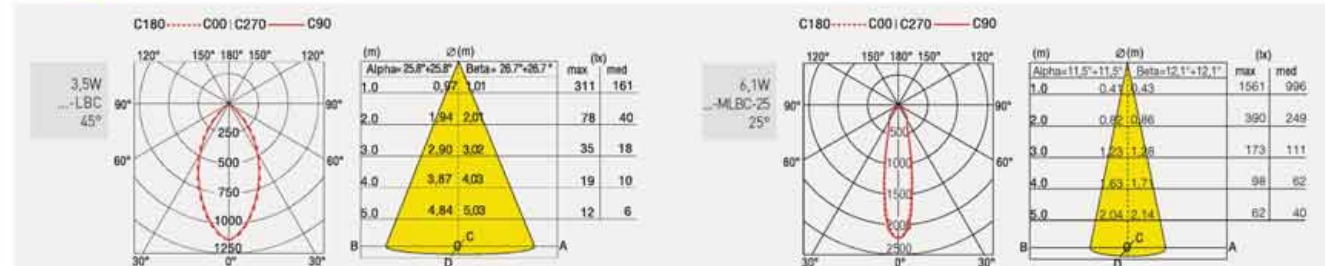

ALIMENTATORI-KIT RGB (se non in dotazione) da ordinare dalla sezione arancio - DRIVERS-RGB KITS (when not supplied) to be ordered from the section orange color



inside

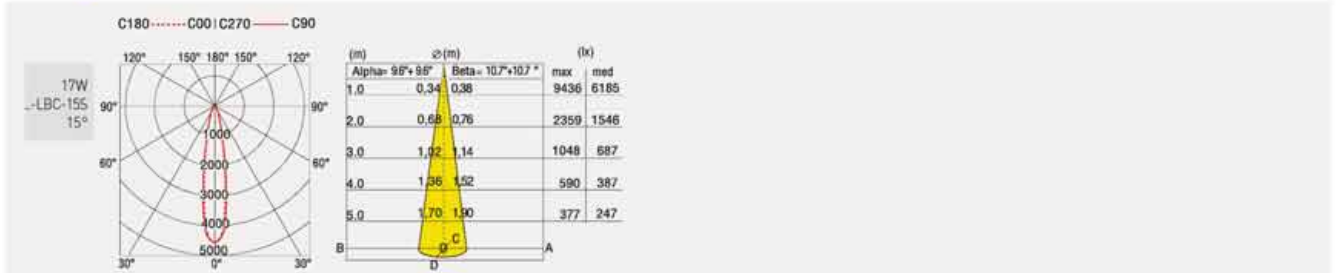

ALIMENTATORI-KIT RGB (se non in dotazione) da ordinare dalla sezione arancio - DRIVERS-RGB KITS (when not supplied) to be ordered from the section orange color



DROP 60S XS - M - XL

- Corpo in alluminio estruso, lunghezza 600 mm.
- Verniciatura in polveri di poliestere.
- Gruppo di alimentazione integrato.
- Kit di sospensione con cavo di alimentazione lunghezza 2 m, e rosone.
- Led durata utile: 50.000 (h) L90 B20.

- Main body made of extruded aluminium, length 600 mm.
- Polyester powder painting.
- Built-in power supply unit.
- Complete with canopy and suspension cable, length 2 m.
- Led life: 50.000 (h) L90 B20.



DROP 60S XS		LED					SISTEMA-SYSTEM					
		W	lm	V	K	CRI	W	lm	W			
	 Kg 0,77	Br	D2213-LBC-S									
		Ne	D2214-LBC-S	3,5W	350	220-240V [350mA]	3000	>90	4,5W	266	59	
		Ga	D2215-LBC-S									
		Br	D2213-LBN-S									
		Ne	D2214-LBN-S	3,5W	380	220-240V [350mA]	4000	>90	4,5W	279	62	
		Ga	D2215-LBN-S									

DROP 60S M		LED					SISTEMA-SYSTEM					
		W	lm	V	K	CRI	W	lm	W	W		
	 Kg 1,20	Br	D2225-MLBC25S	D2225-MLBC40S								
		Ne	D2226-MLBC25S	D2226-MLBC40S	7,3W	817	220-240V [200mA]	3000	>90	8,3W	817	98 (25°)
		Ga	D2227-MLBC25S	D2227-MLBC40S		777						94 (40°)
		Br	D2225-MLBN25S	D2225-MLBN40S								
		Ne	D2226-MLBN25S	D2226-MLBN40S	7,3W	862	220-240V [200mA]	4000	>90	8,3W	862	104 (25°)
		Ga	D2227-MLBN25S	D2227-MLBN40S		817					817	98 (40°)

DROP 60S XL		LED					SISTEMA-SYSTEM						
		W	lm	V	K	CRI	W	lm	W	W			
	 Kg 2,00	Br	D2237-LBC-15S	D2237-LBC-25S	D2237-LBC-40S								
		Ne	D2238-LBC-15S	D2238-LBC-25S	D2238-LBC-40S	17W	2500	220-240V 500mA]	3000	>90	20W	2122	106 (15°)
		Ga	D2239-LBC-15S	D2239-LBC-25S	D2239-LBC-40S							2039	102 (25°)
		Br	D2237-LBN-15S	D2237-LBN-25S	D2237-LBN-40S								
		Ne	D2238-LBN-15S	D2238-LBN-25S	D2238-LBN-40S	17W	2665	220-240V [500mA]	4000	>90	20W	2248	112 (15°)
		Ga	D2239-LBN-15S	D2239-LBN-25S	D2239-LBN-40S							2322	116 (25°)

OP. A richiesta - On request: Led con temperatura di COLORE 2700K - Temperature LED COLOUR 2700K

OP. A richiesta - On request: Adattatore per binario SITRACK - SITRACK adaptor
Finitura Bronzo e Oro - Bronze and Gold finishing



SWING PLAFONE 10

- Corpo esterno in estruso di alluminio verniciato in polveri di poliestere.
- Dissipatore lamellare passivo in estruso di alluminio.
- Riflettore in alluminio purissimo 99,8%.
- Vetro temprato chiaro.
- Led durata utile: 50000 (h) L90 B20.
- Costanza cromaticà: 3 SDCM

- External extruded aluminium body with powder coated painting.
- Extruded aluminium passive heat sink.
- High purity aluminium reflector 99.8%.
- Clear tempered glass.
- Led life: 50000 (h) L90 B20.
- Chromatic consistency: 3 SDCM.



	LED	SISTEMA-SYSTEM		
		W	lm	lm/W
	W lm V K CRI	W	lm	lm/W
Br 2880-LBC-P 2881-LBC-P	17W 2345 220-240V [500mA] 3000 >90	20W	1949 1938	97 97
Br 2880-LBN-P 2881-LBN-P	17W 2665 220-240V [500mA] 4000 >90	20W	2103 2091	105 105

OP:	A richiesta - On request:	disponibile - available				remoto - remote
-----	---------------------------	-------------------------	--	--	--	-----------------

versioni DALI disponibile con alimentatore remoto - available version DALI with remote driver

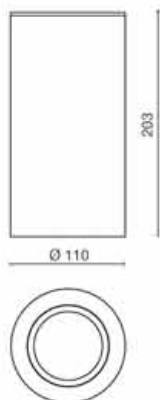

inside

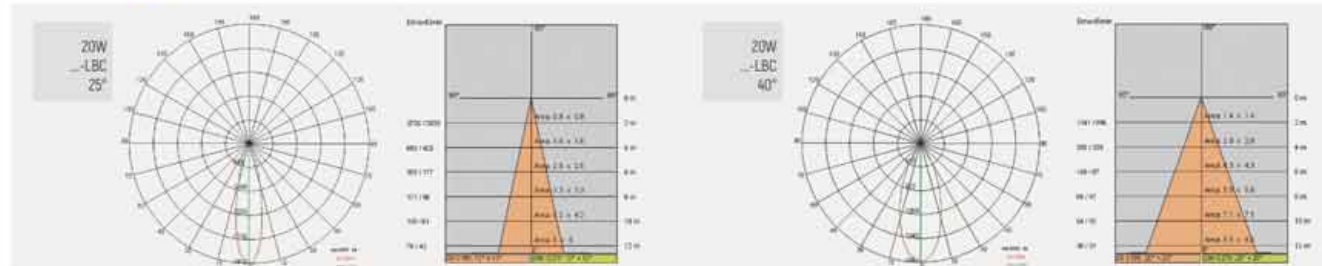

ALIMENTATORI-KIT RGB (se non in dotazione) da ordinare dalla sezione arancio - DRIVERS-RGB KITS (when not supplied) to be ordered from the section orange color



SWING PLAFONE 13

- Corpo esterno in estruso di alluminio verniciato in polveri di poliestere.
- Dissipatore lamellare passivo in estruso di alluminio.
- Riflettore in alluminio purissimo 99,8%.
- Vetro temprato chiaro.
- Led durata utile: 50000 (h) L90 B20.
- Costanza cromaticca: 3 SDCM

- External extruded aluminium body with powder coated painting.
- Extruded aluminium passive heat sink.
- High purity aluminium reflector 99.8%.
- Clear tempered glass.
- Led life: 50000 (h) L90 B20.
- Chromatic consistency: 3 SDCM.



	15	30	60	LED					SISTEMA-SYSTEM		
				W	lm	V	K	CRI	W	lm	lm/W
Br 2885-LBC-P	2886-LBC-P	2887-LBC-P	31W	3960	220-240V [900mA]	3000	>90	35W	3478	99	15°
									3521	101	30°
									3468	99	60°
Br 2885-LBN-P	2886-LBN-P	2887-LBN-P	31W	4270	220-240V [900mA]	4000	>90	35W	3750	107	15°
									3797	108	30°
									3739	107	60°



OP. A richiesta - On request: disponibile - available **FOOD** **DALI** **EM** remoto - remote



inside

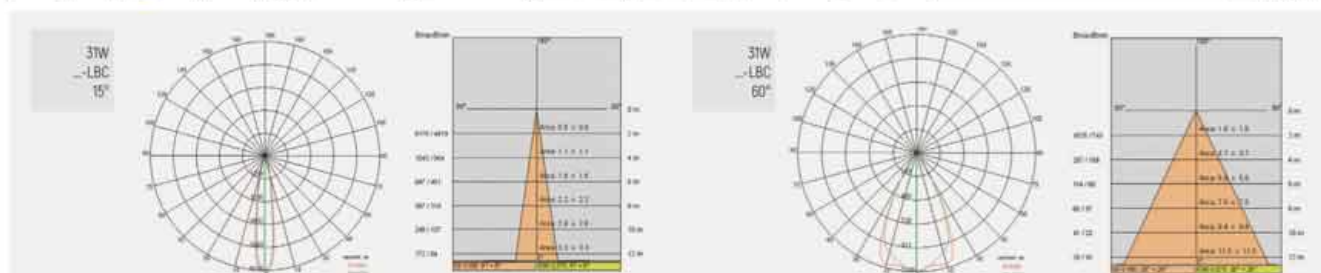

ALIMENTATORI-KIT RGB (se non in dotazione) da ordinare dalla sezione arancio - DRIVERS-RGB KITS (when not supplied) to be ordered from the section orange color



NET RANGE MCL

- Corpo esterno in lamiera di alluminio verniciato in polveri epossipoliestere.
- Apparecchio illuminante estraibile.
- Gruppo di alimentazione incorporato.
- Anello di finitura esterno in pressofusione di alluminio.
- Riflettore in alluminio purissimo.
- Dissipatore lamellare passivo in alluminio estruso.

- Outer body made of aluminium sheet varnished in epoxy.
- Luminaire removable.
- Built-in power supply unit.
- Ring in die-cast aluminium.
- High purity aluminium reflector.
- Lamellar passive heatsink made of extruded aluminium.



	30°	60°	LED					SISTEMI-SYSTEM			
			W	lm	V	K	CRI	W	lm	lp	
Br 63056-LBC-30 Ga 63057-LBC-30	30	60	24W	3365	220-240V (500mA)	3000	>90	27W	3284	122	[30°]
Br 63056-LBI-30 Ga 63057-LBI-30	30	60	24W	3570	220-240V (500mA)	4000	>90	27W	3484	129	[30°]
Br 63058-LBC-30 Ga 63059-LBC-30	30	60	37W	4740	220-240V (1050mA)	3000	>90	41W	4626	113	[30°]
Br 63058-LBI-30 Ga 63059-LBI-30	30	60	37W	4970	220-240V (1050mA)	4000	>90	41W	4850	118	[30°]



IP65
270

OP. A richiesta - On request: Led con temperatura di COLORE 2700K - Temperature LED COLOUR 2700K
disponibile - available



inside

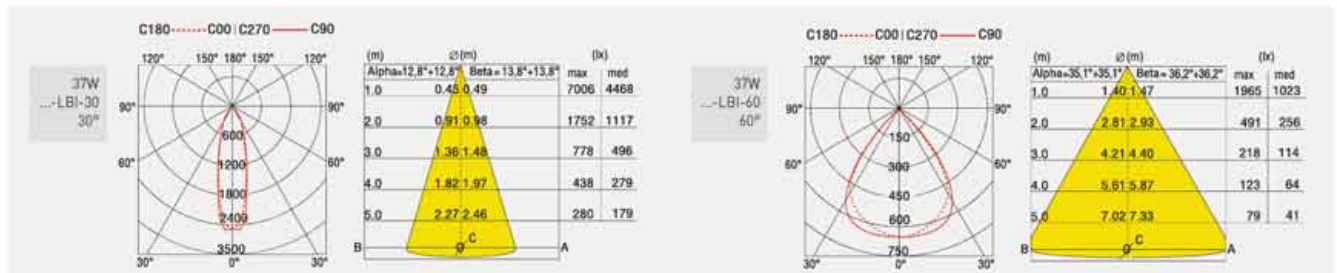

ALIMENTATORI-KIT RGB (se non in dotazione) da ordinare dalla sezione arancio - DRIVERS-RGB KITS (when not supplied) to be ordered from the section orange color



NET RANGE MCL S



- Corpo esterno in lamiera di alluminio verniciato in poveri epossipoliestere.
- Apparecchio illuminante estraibile.
- Gruppo di alimentazione incorporato.
- Anello di finitura esterno in pressofusione di alluminio.
- Riflettore in alluminio purissimo.
- Dissipatore lamellare passivo in alluminio estruso.

- Outer body made of aluminium sheet varnished in epoxy.
- Luminaire removable.
- Built-in power supply unit.
- Ring in die-cast aluminium.
- High purity aluminium reflector.
- Lamellar passive heatsink made of extruded aluminium.

	Br	Ga	LED					SISTEMA-SYSTEM			
			W	lm	V	K	CRI	W	lm	lm/W	
Pg1 270	63056-LBC-30S	63056-LBC-60S	24W	3365	220-240V (700mA)	3000	>90	27W	3284	122	[30°]
	63057-LBI-30S	63057-LBI-60S						2832	105	[60°]	
	63056-LBI-30S	63056-LBI-60S	24W	3570	220-240V (700mA)	4000	>90	27W	3484	129	[30°]
	63057-LBI-30S	63057-LBI-60S						3005	111	[60°]	
	63058-LBC-30S	63058-LBC-60S	37W	4740	220-240V (1050mA)	3000	>90	41W	4626	113	[30°]
	63059-LBI-30S	63059-LBI-60S						4355	106	[60°]	
	63058-LBI-30S	63058-LBI-60S	37W	4970	220-240V (1050mA)	4000	>90	41W	4850	118	[30°]
	63059-LBI-30S	63059-LBI-60S						4180	102	[60°]	

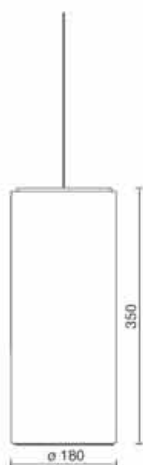

OP: A richiesta - On request. Led con temperatura di COLORE 2700K - Temperature LED COLOUR 2700K disponibile - available



ACC.	TIGES L 600mm	TIGES L 1200mm	KIT FUNI ACCIAIO - STEEL CABLES KIT
Bi	999051	999061	62000-10

Esempio di ordinazione
Ordering example: 63056-LBC-30S + 999051

IP 20

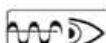

inside

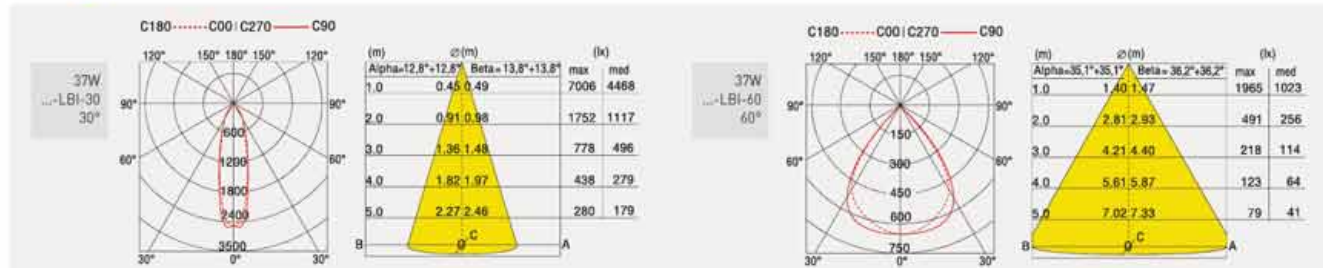

ALIMENTATORI-KIT RGB (se non in dotazione) da ordinare dalla sezione arancio - DRIVERS-RGB KITS (when not supplied) to be ordered from the section orange color





VEGA XS - XL PARETE

- Corpo e struttura in estruso di alluminio verniciato in polveri epossidiche.
 - Vano ottico in pressofusione di alluminio verniciato in polveri.
 - Dissipatore passivo in estruso di alluminio ossidato nero.
 - Ottica orientabile con lenti in metacrilato.
 - Led durata utile: 50.000 (h) L80 B50.
- Housing and structure made of extruded aluminium painted in epoxy powder.
 - Die-cast aluminium optic.
 - Passive heatsink made of extruded aluminium.
 - Adjustable optic with methacrylate lens.
 - Led life: 50.000 (h) L80 B50.



	LED	SISTEMA-SYSTEM		
		W	lm	W
VEGA XS PARETE				
Br 67783-LBC	67783-LBC-60	16W	1280	220-240V [500mA]
Ne 67784-LBC	67784-LBC-60			3000 >90
Gr 67785-LBC	67785-LBC-60			16,5W 1150 69 [30°]
Br 67783-LBN	67783-LBN-60	16W	11280	220-240V [500mA]
Ne 67784-LBN	67784-LBN-60			4000 >90
Gr 67785-LBN	67785-LBN-60			16,5W 1150 69 [30°]

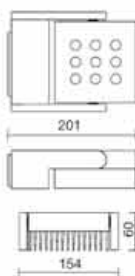

1,70 Kg



	LED	SISTEMA-SYSTEM		
		W	lm	W
VEGA XL PARETE				
Br 67793-LBC	67793-LBC-60	24x2,5W	4600	220-240V [700mA]
Ne 67794-LBC	67794-LBC-60			3000 >90
Gr 67795-LBC	67795-LBC-60			64W 4150 65 [30°]
Br 67793-LBN	67793-LBN-60	24x2,5W	4600	220-240V [700mA]
Ne 67794-LBN	67794-LBN-60			4000 >90
Gr 67795-LBN	67795-LBN-60			64W 4150 65 [30°]

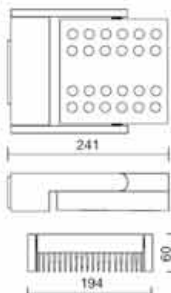

2,40 Kg

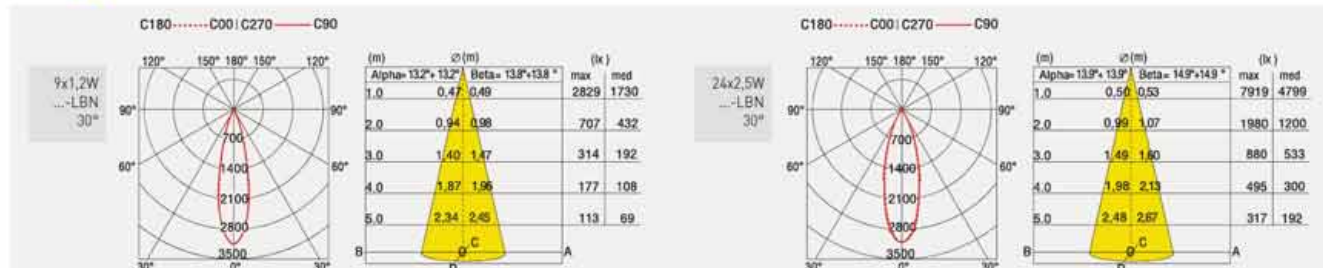

ALIMENTATORI-KIT RGB (se non in dotazione) da ordinare dalla sezione arancio - DRIVERS-RGB KITS (when not supplied) to be ordered from the section orange color



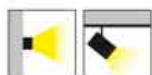

SOLARIS MINI



- Corpo in pressofusione di alluminio.
- Verniciatura in polveri epossidiche con trattamento speciale per esterni.
- Riflettore in alluminio purissimo, finitura PVD.
- Vetro di protezione chiaro serigrafato temprato.
- Guarnizioni e passacavo in gomma siliconica.
- Led durata utile: 50.000 [h] L90 B20.
- Consistenza cromatica: 3 SDCM.

- Body in die-cast aluminium.
- Epoxy powder with special treatment for outdoors.
- Pure aluminium reflector, PVD finish.
- Tempered clear protection glass.
- Silicon rubber gaskets and cable gland.
- Led life: 50.000 [h] L90 B20.
- Chromatic consistency: 3 SDCM.

	Br	Ne	Gr	LED		V	K	CRI	SYSTEM-SYSTEM			SIM	AS
				W	lm				W	lm	lm/W		
PARETE ORIENTABILE - WALL ORIENTABLE 	67960-LBC	67966-LBC		12,4W	1510	220-240V [350mA]	3000	>90	14,4W	1121	78	SIM	AS
	67961-LBC	67967-LBC											
	67962-LBC	67968-LBC											
	67960-LBN	67966-LBN		12,4W	1640	220-240V [350mA]	4000	>90	14,4W	1217	84	SIM	AS
	67961-LBN	67967-LBN											
	67962-LBN	67968-LBN											

	Br	Ne	Gr	LED		V	K	CRI	SYSTEM-SYSTEM			SIM	AS
				W	lm				W	lm	lm/W		
BINARIO - TRACK 	67963-LBC	67969-LBC		12,4W	1510	220-240V [350mA]	3000	>90	14,4W	1121	78	SIM	AS
	67964-LBC	67970-LBC											
	67965-LBC	67971-LBC											
	67963-LBN	67969-LBN		12,4W	1640	220-240V [350mA]	4000	>90	14,4W	1217	84	SIM	AS
	67964-LBN	67970-LBN											
	67965-LBN	67971-LBN											

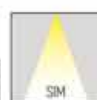

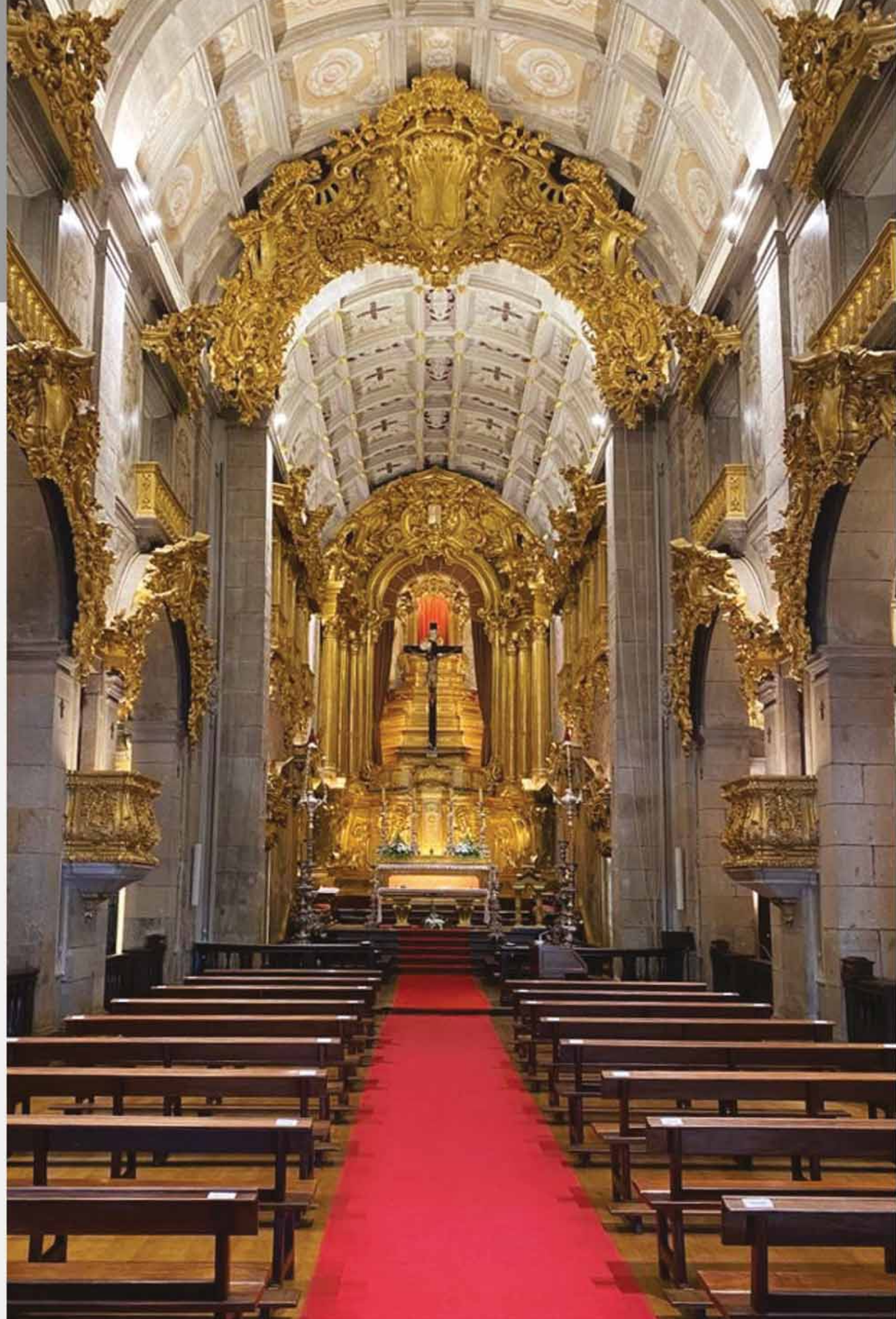



- Corpo in pressofusione di alluminio.
- Verniciatura in polveri poliestere con trattamento speciale per esterni.
- Riflettore in alluminio purissimo, finitura PVD.
- Vetro di protezione chiaro serigrafato temprato.
- Guarnizioni e passacavo in gomma siliconica.
- Led durata utile: 50.000 (h) L90 B20.
- Consistenza cromatica: 3 SDCM.

- Body in die-cast aluminium.
- Epoxy powder with special treatment for outdoors.
- Pure aluminium reflector, PVD finish.
- Tempered clear protection glass.
- Silicon rubber gaskets and cable gland.
- Led life: 50.000 (h) L90 B20.
- Chromatic consistency: 3 SDCM.

SOLARIS MINI FISSO



	Br	Ne	Gr	LED					SISTEMA-SYSTEM		
				W	lm	V	K	CRI	W	lm	IP
PARETE FISSO - FIX WALL	67966-LBC-F	67967-LBC-F	67968-LBC-F	12,4W	1510	220-240V [350mA]	3000	>90	14,4W	1054	73
	67966-LBN-F	67967-LBN-F	67968-LBN-F	12,4W	1640	220-240V [350mA]	4000	>90	14,4W	1145	80

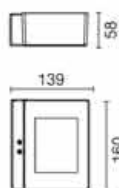

Kg
2,00

OP: A richiesta - On request: versioni DALI disponibile con alimentatore remoto
available version DALI with remote driver

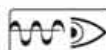



SOLARIS MCL

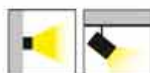

- Corpo in pressofusione di alluminio.
- Verniciatura in polveri epossidiche con trattamento speciale per esterni.
- Riflettore in alluminio purissimo, finitura PVD.
- Vetro di protezione chiaro serigrafato temprato.
- Guarnizioni e passacavo in gomma siliconica.
- Led durata utile: 50.000 (h) L90 B20.
- Consistenza cromatica: 3 SDCM.

- Body in die-cast aluminium.
- Epoxy powder with special treatment for outdoors.
- Pure aluminium reflector, PVD finish.
- Tempered clear protection glass.
- Silicon rubber gaskets and cable gland.
- Led life: 50.000 (h) L90 B20.
- Chromatic consistency: 3 SDCM.

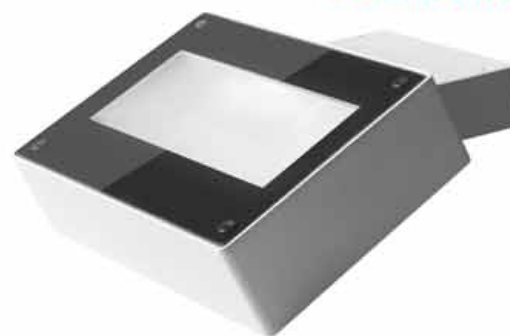

	Br	Ne	Gr	LED					SISTEMA-SYSTEM			
				W	lm	V	K	CRI	W	lm	lm/W	
PARETE ORIENTABILE - WALL ORIENTABLE 	67950-LBC	67951-LBC	67952-LBC	40W	5840	220-240V (600mA)	3000	>90	44W	4998	114	
	67950-LBN	67951-LBN	67952-LBN	40W	5980	220-240V (600mA)	4000	>90	44W	5396	123	
	67950-LBC-DA	67951-LBC-DA	67952-LBC-DA	40W	5540	220-240V (600mA)	3000	>90	44W	4998	114	
	67950-LBN-DA	67951-LBN-DA	67952-LBN-DA	40W	5980	220-240V (600mA)	4000	>90	44W	5396	123	

	Br	Ne	Gr	LED					SISTEMA-SYSTEM			
				W	lm	V	K	CRI	W	lm	lm/W	
BINARIO - TRACK 	67953-LBC	67954-LBC	67955-LBC	40W	5540	220-240V (600mA)	3000	>90	44W	4998	114	
	67953-LBN	67954-LBN	67955-LBN	40W	5989	220-240V (600mA)	4000	>90	44W	5396	123	
	67953-LBC-DA	67954-LBC-DA	67955-LBC-DA	40W	5540	220-240V (600mA)	3000	>90	44W	4998	114	
	67953-LBN-DA	67954-LBN-DA	67955-LBN-DA	40W	5980	220-240V (600mA)	4000	>90	44W	5396	123	

A richiesta - On request: classe - class disponibile - available DIM 1+ 10V

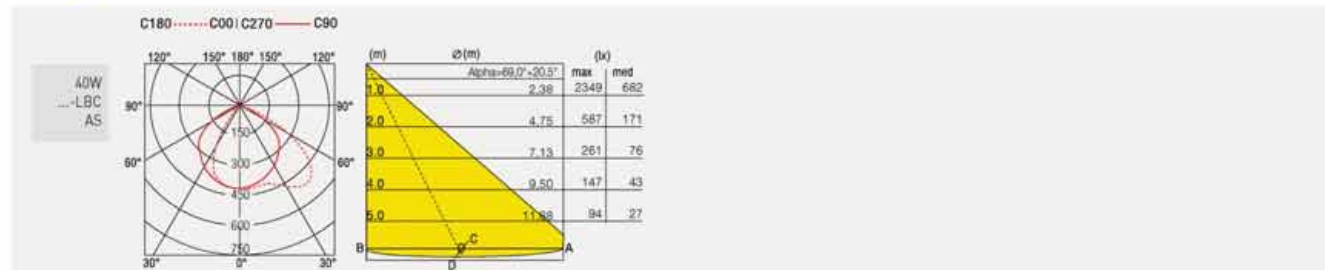

ALIMENTATORI-KIT RGB (se non in dotazione) da ordinare dalla sezione arancio - DRIVERS-RGB KITS (when not supplied) to be ordered from the section orange color





- Corpo in pressofusione di alluminio.
- Verniciatura in polveri poliestere con trattamento speciale per esterni.
- Riflettore in alluminio purissimo, finitura PVD.
- Vetro di protezione chiaro serigrafato temprato.
- Guarnizioni e passacavo in gomma siliconica.
- Led durata utile: 50.000 (h) L90 B20.
- Consistenza cromatica: 3 SDCM.

- Body in die-cast aluminium.
- Epoxy powder with special treatment for outdoors.
- Pure aluminium reflector, PVD finish.
- Tempered clear protection glass.
- Silicon rubber gaskets and cable gland.
- Led life: 50.000 (h) L90 B20.
- Chromatic consistency: 3 SDCM.

SOLARIS MCL FISSO

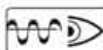

	Br	Ne	Gr	LED			SISTEMA-SYSTEM				
				W	lm	V	K	CRI	W	lm	lm/W
PARETE FISSO - FIX WALL 	67950-LBC-F	67951-LBC-F	67952-LBC-F	40W	5540	220-240V (600mA)	3000	>90	44W	4898	114
	67950-LBN-F	67951-LBN-F	67952-LBN-F								
	67950-LBC-DA-F	67951-LBC-DA-F	67952-LBC-DA-F	40W	5540	220-240V (600mA)	3000	>90	44W	4898	114
	67950-LBN-DA-F	67951-LBN-DA-F	67952-LBN-DA-F								

IP 65
IK 06

inside outside

C180 C00 | C270 — C90

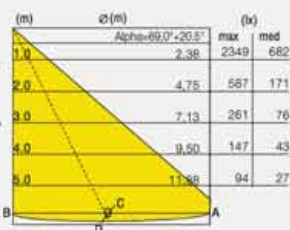
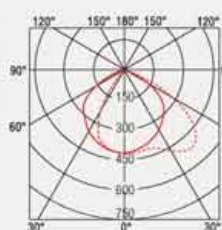

ALIMENTATORI-KIT RGB (se non in dotazione) da ordinare dalla sezione arancio - DRIVERS-RGB KITS (when not supplied) to be ordered from the section orange color



BIG PLAFONE 270

- Verniciatura per interni in polveri epossidiche.
- Disco fissaggio e dissipazione Led in alluminio.
- Diffusore in metacrilato bi-satinato.
- Morsetto ad innesto rapido per collegamento cavo di rete.
- Schermo diffusore in metacrilato bi-satinato.
- Struttura interna in lamiera di acciaio pre-zincata.
- Pressacavo in gomma silconica.
- Led durata utile: 50.000 (h) L70 B10.
- **UGR <19 su richiesta.**



- Indoor epoxy powder painting.
- Aluminium fixing disk and heatsink.
- Bi-satin methacrylate diffuser.
- Fast connector for supply cable.
- Bi-satin methacrylate diffuser.
- Internal structure of pre-galvanized steel sheet.
- Cable gland in silicon rubber.
- Led life: 50.000 (h) L70 B10.
- **UGR <19 on request.**

	LED	SISTEMI-SYSTEM					
		W	lm	lm/W			
Br 5505P-LBC Ne 5506P-LBC Ga 5507P-LBC	14W 1800	220-240V [500mA]	3000	>90	16W	1443	90
Br 5505P-LBN Ne 5506P-LBN Ga 5507P-LBN	14W 1950	220-240V [500mA]	4000	>90	16W	1563	98
DIMM 1+10V Br 5505P-LBC-DIM Ne 5506P-LBC-DIM Ga 5507P-LBC-DIM	14W 1800	220-240V [500mA]	3000	>90	16W	1443	90
Br 5505P-LBN-DIM Ne 5506P-LBN-DIM Ga 5507P-LBN-DIM	14W 1950	220-240V [500mA]	4000	>90	16W	1563	98
SA EMERGENZA - EMERGENCY Br 5505P-LBC-EM1 Ne 5506P-LBC-EM1 Ga 5507P-LBC-EM1	14W 1800	220-240V [500mA]	3000	>90	16W	1443	90
Br 5505P-LBN-EM1 Ne 5506P-LBN-EM1 Ga 5507P-LBN-EM1	14W 1950	220-240V [500mA]	4000	>90	16W	1563	98
DALI DIM-DALI/PUSH Br 5505P-LBC-DA Ne 5506P-LBC-DA Ga 5507P-LBC-DA	14W 1800	220-240V [500mA]	3000	>90	16W	1443	90
Br 5505P-LBN-DA Ne 5506P-LBN-DA Ga 5507P-LBN-DA	14W 1950	220-240V [500mA]	4000	>90	16W	1563	98

OP. A richiesta - On request: **UGR <19**

ACC. 409600 Schermo DIAMOND PRISM per versione UGR <19 - DIAMOND PRISM diffuser for UGR <19 version

IP 40

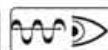

inside

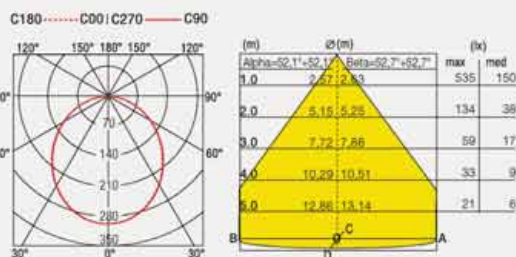

ALIMENTATORI-KIT RGB (se non in dotazione) da ordinare dalla sezione arancio - DRIVERS-RGB KITS (when not supplied) to be ordered from the section orange color



BIG PLAFONE 360



- Verniciatura per interni in polveri epossidiche.
- Disco fissaggio e dissipazione Led in alluminio.
- Diffusore in metacrilato bi-satinato.
- Morsetto ad innesto rapido per collegamento cavo di rete.
- Schermo diffusore in metacrilato bi-satinato.
- Struttura interna in lamiera di acciaio pre-zincata.
- Pressacavo in gomma siliconica.
- **UGR <19 su richiesta.**

- Indoor epoxy powder painting.
- Aluminium fixing disk and heatsink.
- Bi-satin methacrylate diffuser.
- Fast connector for supply cable.
- Bi-satin methacrylate diffuser.
- Internal structure of pre-galvanized steel sheet.
- Cable gland in silicon rubber.
- **UGR <19 on request.**

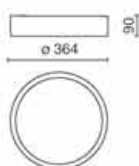

LED	SISTEMA-SYSTEM		
	W	lm	W
Br 5513P-LBC Ne 5514P-LBC Ga 5515P-LBC	27W	4000	31W
Br 5513P-LBN Ne 5514P-LBN Ga 5515P-LBN	27W	4200	31W
DIMM 1+10V Br 5513P-LBC-DIM Ne 5514P-LBC-DIM Ga 5515P-LBC-DIM	7W	4000	31W
Br 5513P-LBN-DIM Ne 5514P-LBN-DIM Ga 5515P-LBN-DIM	27W	4200	31W
SA EMERGENZA - EMERGENCY Br 5513P-LBC-EM1 Ne 5514P-LBC-EM1 Ga 5515P-LBC-EM1	27W	4000	31W
Br 5513P-LBN-EM1 Ne 5514P-LBN-EM1 Ga 5515P-LBN-EM1	27W	4200	31W
DALI DIM-DALI/PUSH Br 5513P-LBC-DA Ne 5514P-LBC-DA Ga 5515P-LBC-DA	27W	4000	31W
Br 5513P-LBN-DA Ne 5514P-LBN-DA Ga 5515P-LBN-DA	27W	4200	31W

Reg. 2.50



OP. A richiesta - On request: **UGR <19**

ACC. 409700 Schermo DIAMOND PRISM per versione UGR <19 - DIAMOND PRISM diffuser for UGR <19 version

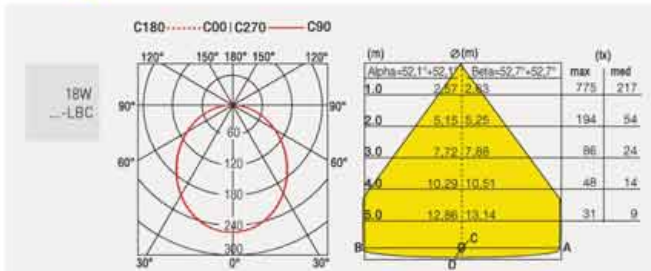

ALIMENTATORI-KIT RGB (se non in dotazione) da ordinare dalla sezione arancio - DRIVERS-RGB KITS (when not supplied) to be ordered from the section orange color



BIG PLAFONE 550

- Verniciatura per interni in polveri epossidiche.
- Disco fissaggio e dissipazione Led in alluminio.
- Diffusore in metacrilato bi-satinato.
- Morsetto ad innesto rapido per collegamento cavo di rete.
- Schermo diffusore in metacrilato bi-satinato.
- Struttura interna in lamiera di acciaio pre-zincata.
- Pressacavo in gomma siliconica.
- **UGR <19 su richiesta.**



- Indoor epoxy powder painting.
- Aluminium fixing disk and heatsink.
- Bi-satin methacrylate diffuser.
- Quick connect terminal for connecting the network cable.
- Bi-satin methacrylate diffuser.
- Internal structure of pre-galvanized steel sheet.
- Cable gland in silicon rubber.
- **UGR <19 on request.**

	Br	Ne	Ga	LED			SISTEMA-SYSTEM				
				W	lm	V	K	CRI	W	lm	W
	5485P-LBC			42W	5500	220-240V [700mA]	3000	>90	46W	4411	96
	5486P-LBC										
	5487P-LBC										
	5485P-LBN			42W	5740	220-240V [700mA]	4000	>90	46W	4603	100
	5486P-LBN										
	5487P-LBN										
DIMM 1-10V	5485P-LBC-DIM			42W	5500	220-240V [700mA]	3000	>90	46W	4411	96
	5486P-LBC-DIM										
	5487P-LBC-DIM										
	5485P-LBN-DIM			42W	5740	220-240V [700mA]	4000	>90	46W	4603	100
	5486P-LBN-DIM										
	5487P-LBN-DIM										
	SA EMERGENZA - EMERGENCY			42W	5500	220-240V [700mA]	3000	>90	46W	4411	96
	5485P-LBC-EM1		1h								
	5486P-LBC-EM1										
	5485P-LBN-EM1		1h	42W	5740	220-240V [700mA]	4000	>90	46W	4603	100
	5486P-LBN-EM1										
	5487P-LBN-EM1										
DALI DIM-DALI/PUSH											
	5485P-LBC-DA			42W	5500	220-240V [700mA]	3000	>90	46W	4411	96
	5486P-LBC-DA										
	5487P-LBC-DA										
	5485P-LBN-DA			42W	5740	220-240V [700mA]	4000	>90	46W	4603	100
	5486P-LBN-DA										
	5487P-LBN-DA										

SEMPRE ACCESSO: n. 4 schede Led funzionanti per tutta la superficie dello schermo del prodotto.

EMERGENZA: n. 2 schede Led alternate funzionanti e n° 2 schede in OFF

ALWAYS ON: n. 4 Led cards switch on for the whole screen's surface.

EMERGENCY MODE: n. 2 Led alternated cards switch on and n. 2 Led cards Switch OFF.

OP. A richiesta - On request: **UGR <19**

ACC. 409500 Schermo DIAMOND PRISM per versione UGR <19 - DIAMOND PRISM diffuser for UGR <19 version

IP 40

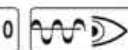

inside

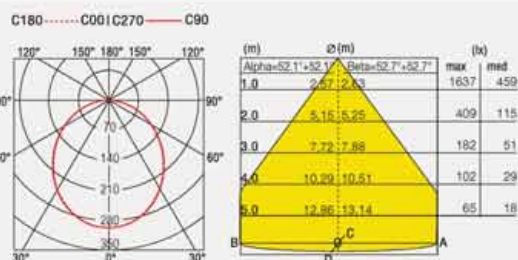

ALIMENTATORI-KIT RGB (se non in dotazione) da ordinare dalla sezione arancio - DRIVERS-RGB KITS (when not supplied) to be ordered from the section orange color

BIG PLAFONE 750



- Verniciatura per interni in polveri epossidiche.
- Disco fissaggio e dissipazione Led in alluminio.
- Diffusore in metacrilato bi-satinato.
- Morsetto ad innesto rapido per collegamento cavo di rete.
- Schermo diffusore in metacrilato bi-satinato.
- Struttura interna in lamiera di acciaio pre-zincata.
- Pressacavo in gomma siliconica.
- **UGR <19 su richiesta.**

- Indoor epoxy powder painting.
- Aluminium fixing disk and heatsink.
- Bi-satin methacrylate diffuser.
- Quick connect terminal for connecting the network cable.
- Bi-satin methacrylate diffuser.
- Internal structure of pre-galvanized steel sheet.
- Cable gland in silicon rubber.
- **UGR <19 on request.**

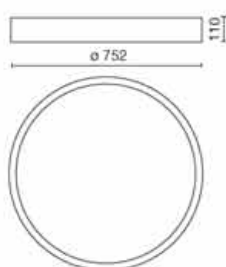

	LED	SISTEMA-SYSTEM						
		W	lm	V	K	CRI	W	lm
Br 5491P-LBC Ne 5492P-LBC Ga 5493P-LBC	80W 11248	220-240V (700mA)	3000	>90	84W	8572	102	
Br 5491P-LBN Ne 5492P-LBN Ga 5493P-LBN	80W 11488	220-240V (700mA)	4000	>90	84W	8755	104	
DIMM 1+10V Br 5491P-LBC-DIM Ne 5492P-LBC-DIM Ga 5493P-LBC-DIM	80W 11248	220-240V (700mA)	3000	>90	84W	8572	102	
Br 5491P-LBN-DIM Ne 5492P-LBN-DIM Ga 5493P-LBN-DIM	80W 11488	220-240V (700mA)	4000	>90	84W	8755	104	
SA EMERGENZA - EMERGENCY Br 5491P-LBC-EM1 Ne 5492P-LBC-EM1 Ga 5493P-LBC-EM1	80W 11248	220-240V (700mA)	3000	>90	84W	8572	102	
Br 5491P-LBN-EM1 Ne 5492P-LBN-EM1 Ga 5493P-LBN-EM1	80W 11488	220-240V (700mA)	4000	>90	84W	8755	104	
DALI DIM-DALI/PUSH Br 5491P-LBC-DA Ne 5492P-LBC-DA Ga 5493P-LBC-DA	80W 11248	220-240V (700mA)	3000	>90	84W	8572	102	
Br 5491P-LBN-DA Ne 5492P-LBN-DA Ga 5493P-LBN-DA	80W 11488	220-240V (700mA)	4000	>90	84W	8755	104	

12.40

Sa

SEMPRE ACCESSO: n. 8 schede Led funzionanti per tutta la superficie dello schermo del prodotto.
EMERGENZA: n. 4 schede Led alternate funzionanti e n. 4 schede in OFF

ALWAYS ON: n. 8 Led cards switch on for the whole screen's surface.
EMERGENCY MODE: n. 4 Led alternated cards switch on and n. 4 Led cards Switch OFF.

OP: A richiesta - On request: **UGR <19**

ACC: **409800** Schermo DIAMOND PRISM per versione UGR <19 - DIAMOND PRISM diffuser for UGR <19 version

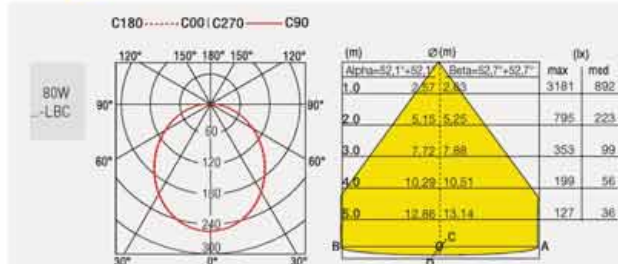

ALIMENTATORI-KIT RGB (se non in dotazione) da ordinare dalla sezione arancio - DRIVERS-RGB KITS (when not supplied) to be ordered from the section orange color





BIG PLAFONE 1030



- Verniciatura per interni in polveri epossidiche.
- Disco fissaggio e dissipazione Led in alluminio.
- Diffusore in metacrilato bi-satinato.
- Morsetto ad innesto rapido per collegamento cavo di rete.
- Schermo diffusore in metacrilato bi-satinato.
- Struttura interna in lamiera di acciaio pre-zincata.
- Pressacavo in gomma siliconica.
- **UGR <19 su richiesta.**

- Indoor epoxy powder painting.
- Aluminium fixing disk and heatsink.
- Bi-satin methacrylate diffuser.
- Quick connect terminal for connecting the network cable.
- Bi-satin methacrylate diffuser.
- Internal structure of pre-galvanized steel sheet.
- Cable gland in silicon rubber.
- **UGR <19 on request.**

	LED	SISTEMA-SYSTEM		
		W	lm	lm/W
Br 5497P-LBC Ne 5498P-LBC Ga 5499P-LBC	187,5W 25100	220-240V (1050mA)	3000 >90	191,5W 19123 100
Br 5497P-LBN Ne 5498P-LBN Ga 5499P-LBN	187,5W 25520	220-240V (1050mA)	4000 >90	191,5W 19382 101
Br 5497P-LBC-EMI Ne 5498P-LBC-EMI Ga 5499P-LBC-EMI	190W 25100	220-240V (1050mA)	3000 >90	191,5W 19123 100
Br 5497P-LBN-EMI Ne 5498P-LBN-EMI Ga 5499P-LBN-EMI	190W 25520	220-240V (1050mA)	4000 >90	191,5W 19382 101
Br 5497P-LBC-DA Ne 5498P-LBC-DA Ga 5499P-LBC-DA	187,5W 25100	220-240V (1050mA)	3000 >90	191,5W 19129 100
Br 5497P-LBN-DA Ne 5498P-LBN-DA Ga 5499P-LBN-DA	187,5W 25520	220-240V (1050mA)	4000 >90	191,5W 19449 102

SEMPRE ACCESSO: n. 8 schede Led funzionanti per tutta la superficie dello schermo del prodotto.

EMERGENZA: n. 4 schede Led alternate funzionanti e n° 4 schede in OFF.

ALWAYS ON: n. 8 Led cards switch on for the whole screen's surface.

EMERGENCY MODE: n. 4 Led alternate cards switch on and n. 4 Led cards Switch OFF.

OP. A richiesta - On request: versioni dimmerabili 1+10V - dimmable 1+10V

UGR <19

ACC. 409900 Schermo DIAMOND PRISM per versione UGR <19 - DIAMOND PRISM diffuser for UGR <19 version



ALIMENTATORI-KIT RGB (se non in dotazione) da ordinare dalla sezione arancio - DRIVERS-RGB KITS (when not supplied) to be ordered from the section orange color





BIG SOSPENSIONE 270-360

- Verniciatura per interni in polveri epossidiche.
 - Pressacavo in gomma siliconica.
 - Cavo alimentazione lunghezza 2 m.
 - Bloccacavo termoplastico.
 - Disco fissaggio e dissipazione Led in alluminio.
 - Diffusore superiore in policarbonato.
 - Diffusore inferiore in metacrilato bi-satinato.
 - Cavetti di sospensione in acciaio con morsetto automatico.
Diametro 1,5 mm - Sezione 0,87 mmq - Portata max 25Kg - Carico di rottura 194Kg.
 - Led durata utile: 50.000 (h) L70 B10.
 - **UGR <19 su richiesta.**
- Indoor epoxy powder painting.
 - Cable gland in silicon rubber.
 - Cable length 2 m.
 - Thermoplastic cable clamp.
 - Aluminium fixing disk and heatsink.
 - Polycarbonate upper diffuser.
 - Bi-satin methacrylate diffuser.
 - Steel suspension cables with automatic clamp.
Diameter 1,5 mm - Cables section 0,87 mmq - Max load 25Kg - Breaking load 194Kg.
 - Led life: 50.000 (h) L70 B10.
 - **UGR <19 on request.**



	LED				SISTEMA-SYSTEM			
	W	lm	V	K	CRI	W	lm	lm/W
<p>BIG SOSPENSIONE 270 ON-OFF LUCE DIRETTA - DIRECT LIGHT Br 5505-LBC Ne 5506-LBC Gr 5507-LBC</p> <p>Br 5505-LBN Ne 5506-LBN Gr 5507-LBN</p> <p>DIM 1-10V Br 5505-LBC-DIM Ne 5506-LBC-DIM Gr 5507-LBC-DIM</p> <p>Br 5505-LBN-DIM Ne 5506-LBN-DIM Gr 5507-LBN-DIM</p> <p>SA EMERGENZA - EMERGENCY Br 5505-LBC-EM1 Ne 5506-LBC-EM1 1h Gr 5507-LBC-EM1</p> <p>Br 5505-LBN-EM1 Ne 5506-LBN-EM1 1h Gr 5507-LBN-EM1</p> <p>DALI DIM-DALI/PUSH Br 5505-LBC-DA Ne 5506-LBC-DA Ga 5507-LBC-DA</p> <p>Br 5505-LBN-DA Ne 5506-LBN-DA Ga 5507-LBN-DA</p>	14W	1800	220-240V [500mA]	3000	>90	16W	1443	90
	14W	1950	220-240V [500mA]	4000	>90	16W	1563	98
	14W	1800	220-240V [500mA]	3000	>90	15W	1443	90
	14W	1950	220-240V [500mA]	4000	>90	16W	1563	98
	14W	1800	220-240V [500mA]	3000	>90	16W	1443	90
	14W	1950	220-240V [500mA]	4000	>90	16W	1563	98
	14W	1800	220-240V [500mA]	3000	>90	16W	1443	90
	14W	1950	220-240V [500mA]	4000	>90	16W	1563	98

ACC. 409600 Schermo DIAMOND PRISM per versione UGR<19 - DIAMOND PRISM diffuser for UGR<19 version



inside

C180.....C00 | C270 — C90

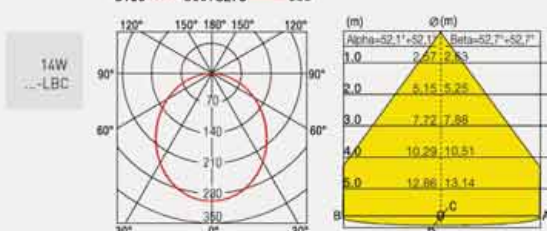

C180.....C00 | C270 — C90

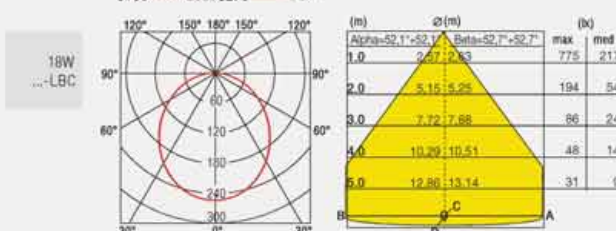

ALIMENTATORI-KIT RGB (se non in dotazione) da ordinare dalla sezione arancio - DRIVERS-RGB KITS (when not supplied) to be ordered from the section orange color



	LED					SISTEMA-SYSTEM				
	W	lm	V	K	CRI	W	lm	lm/W		
	BIG SOSPENSIONE 360									
	ON-OFF									
	LUCE DIRETTA - DIRECT LIGHT									
	Br	5513-LBC								
	Ne	5514-LBC	27W	4000	220-240V [500mA]	3000	>90	31W	3213	104
	Ga	5515-LBC								
	Br	5513-LBN								
	Ne	5514-LBN	27W	4200	220-240V [500mA]	4000	>90	31W	3374	109
	Ga	5515-LBN								
	DIMM 1+10V									
	Br	5513-LBC-DIM								
	Ne	5514-LBC-DIM	7W	4000	220-240V [500mA]	3000	>90	31W	3213	104
Ga	5515-LBC-DIM									
Br	5513-LBN-DIM									
Ne	5514-LBN-DIM	27W	4200	220-240V [500mA]	4000	>90	31W	3374	109	
Ga	5515-LBN-DIM									
	SA EMERGENZA - EMERGENCY									
	Br	5513-LBC-EM1								
	Ne	5514-LBC-EM1	27W	4000	220-240V [500mA]	3000	>90	31W	3213	104
	Ga	5515-LBC-EM1								
	Br	5513-LBN-EM1								
	Ne	5514-LBN-EM1	27W	4200	220-240V [500mA]	4000	>90	31W	3374	109
Ga	5515-LBN-EM1									
	DALI DIM-DALI/PUSH									
	Br	5513-LBC-DA								
	Ne	5514-LBC-DA	27W	4000	220-240V [500mA]	3000	>90	31W	3213	104
	Ga	5515-LBC-DA								
	Br	5513-LBN-DA								
	Ne	5514-LBN-DA	27W	4200	220-240V [500mA]	4000	>90	31W	3374	109
Ga	5515-LBN-DA									

OP. A richiesta - On request: disponibile - available version

UGR <19

ACC. 409700 Schermo DIAMOND PRISM per versione UGR<19 - DIAMOND PRISM diffuser for UGR version

IP 20

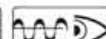

inside

ALIMENTATORI-KIT RGB (se non in dotazione) da ordinare dalla sezione arancio - DRIVERS-RGB KITS (when not supplied) to be ordered from the section orange color



BIG SOSPENSIONE 550

- Verniciatura per interni in polveri epossidiche.
 - Pressacavo in gomma siliconica.
 - Cavo alimentazione lunghezza 2 m.
 - Bloccacavo termoplastico.
 - Disco fissaggio e dissipazione Led in alluminio.
 - Diffusore superiore in policarbonato.
 - Diffusore inferiore in metacrilato bi-satinato.
 - Cavetti di sospensione in acciaio con morsetto automatico.
Diametro 1,4 mm - Sezione 0,87 mmq - Portata max 25Kg
Carico di rottura 194Kg.
 - Led durata utile: 50.000 (h) L70 B10.
 - UGR <19 su richiesta.
- Indoor epoxy powder painting.
 - Cable gland in silicon rubber.
 - Cable length 2 m.
 - Thermoplastic cable clamp.
 - Aluminium fixing disk and heatsink.
 - Polycarbonate upper diffuser.
 - Bi-satin methacrylate diffuser.
 - Steel suspension cables with automatic clamp.
Diameter 1,5 mm - Cables section 0,87 mmq
Max load 25Kg - Breaking load 194Kg.
 - Led life: 50.000 (h) L70 B10.
 - UGR <19 on request.



	LED	SISTEMA-SYSTEM		
		W	lm	UGR
ON-OFF LUCE DIRETTA - DIRECT LIGHT Br 5485-LBC Ne 5486-LBC Gr 5487-LBC 	42W 5500	220-240V (700mA)	3000 >90	46W 4411 96
Br 5485-LBN Ne 5486-LBN Gr 5487-LBN 	42W 5740	220-240V (700mA)	4000 >90	46W 4603 100
LUCE DIRETTA + INDIRETTA - DIRECT + INDIRECT LIGHT Br 5488-LBC Ne 5489-LBC Gr 5490-LBC 	42W 5500 21W 2750	220-240V (700mA)	3000 >90	46W 4218 94
Br 5488-LBN Ne 5489-LBN Gr 5490-LBN 	42W 5740 21W 2870	220-240V (700mA)	4000 >90	46W 4400 99
DIM 1-10V LUCE DIRETTA - DIRECT LIGHT Br 5485-LBC-DIM Ne 5486-LBC-DIM Gr 5487-LBC-DIM 	42W 5500	220-240V (700mA)	3000 >90	46W 4411 96
Br 5485-LBN-DIM Ne 5486-LBN-DIM Gr 5487-LBN-DIM 	42W 5740	220-240V (700mA)	4000 >90	46W 4603 100
LUCE DIRETTA + INDIRETTA - DIRECT + INDIRECT LIGHT Br 5488-LBC-DIM Ne 5489-LBC-DIM Gr 5490-LBC-DIM 	42W 5500 21W 2750	220-240V (700mA)	3000 >90	46W 4218 94
Br 5488-LBN-DIM Ne 5489-LBN-DIM Gr 5490-LBN-DIM 	42W 5740 21W 2870	220-240V (700mA)	4000 >90	46W 4400 99
SA EMERGENZA - EMERGENCY LUCE DIRETTA - DIRECT LIGHT Br 5485-LBC-EM1 Ne 5486-LBC-EM1 Gr 5487-LBC-EM1 	42W 5500	220-240V (700mA)	3000 >90	46W 4411 96
Br 5485-LBN-EM1 Ne 5486-LBN-EM1 Gr 5487-LBN-EM1 	42W 5740	220-240V (700mA)	4000 >90	46W 4603 100

SEMPRE ACCESSO: n. 4 schede Led funzionanti per tutta la superficie dello schermo del prodotto.
EMERGENZA: n. 2 schede Led alternate funzionanti e n. 2 schede in OFF.

ALWAYS ON: n. 4 Led cards switch on for the whole screen's surface.
EMERGENCY MODE: n. 2 Led alternate cards switch on and n. 2 Led cards Switch OFF.



OP. A richiesta - On request: disponibile - available version



ACC. 409500 Schermo DIAMOND PRISM per versione UGR <19 - DIAMOND PRISM diffuser for UGR <19 version



	LED					SISTEMA-SYSTEM		
	W	lm	V	K	CRI	W	lm	W
 <p>LUCE DIRETTA - DIRECT LIGHT</p> <p>Br 5485-LBC-DA Ne 5486-LBC-DA Ga 5487-LBC-DA</p>	42W	5500	220-240V (700mA)	3000	>90	46W	4411	96
<p>Br 5485-LBN-DA Ne 5486-LBN-DA Ga 5487-LBN-DA</p>	42W	5740	220-240V (700mA)	4000	>90	46W	4603	100
<p>LUCE DIRETTA + INDIRETTA - DIRECT + INDIRECTLIGHT</p> <p>Br 5488-LBC-DA Ne 5489-LBC-DA Ga 5490-LBC-DA</p> <p>DIRETTA-DIRECT INDIRETTA-INDIRECT</p>	42W 21W	5500 2750	220-240V (700mA)	3000	>90	46W 21W	4218 2108	94
<p>Br 5488-LBN-DA Ne 5489-LBN-DA Ga 5490-LBN-DA</p> <p>DIRETTA-DIRECT INDIRETTA-INDIRECT</p>	42W 21W	5740 2870	220-240V (700mA)	3000	>90	46W 21W	4401 2200	99

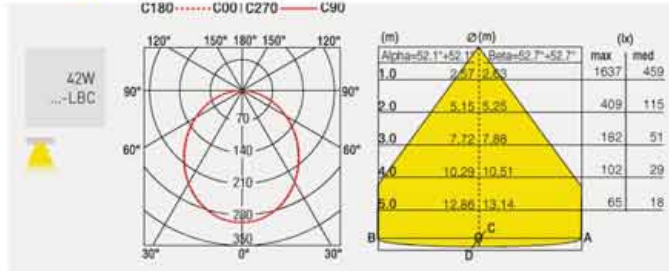
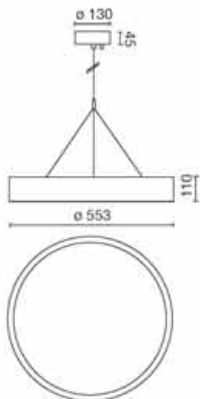

ALIMENTATORI-KIT RGB (se non in dotazione) da ordinare dalla sezione arancio - DRIVERS-RGB KITS (when not supplied) to be ordered from the section orange color





BIG SOSPENSIONE 750

- Verniciatura per interni in polveri epossidiche.
 - Pressacavo in gomma silconica.
 - Cavo alimentazione lunghezza 2 m.
 - Bloccacavo termoplastico.
 - Disco fissaggio e dissipazione Led in alluminio.
 - Diffusore superiore in policarbonato.
 - Diffusore inferiore in metacrilato bi-satinato.
 - Cavetti di sospensione in acciaio con morsetto automatico.
 - Diametro 1,5 mm - Sezione 0,87 mmq
 - Portata max 25Kg - Carico di rottura 194Kg.
 - Led durata utile: 50.000 (h) L70 B10.
 - UGR <19 su richiesta.
- Indoor epoxy powder painting.
 - Cable gland in silicon rubber.
 - Cable length 2 m.
 - Thermoplastic cable clamp.
 - Aluminium fixing disk and heatsink.
 - Polycarbonate upper diffuser.
 - Bi-satin methacrylate diffuser.
 - Steel suspension cables with automatic clamp.
 - Diameter 1,5 mm - Cables section 0,87 mmq
 - Max load 25Kg - Breaking load 194Kg.
 - Led life: 50.000 (h) L70 B10.
 - UGR <19 on request.



	LED	SISTEMA-SYSTEM		
		W	lm	UGR
ON-OFF LUCE DIRETTA - DIRECT LIGHT Br 5491-LBC Ne 5492-LBC Gr 5493-LBC	80W 11248 220-240V [700mA]	3000 >90	84W 8572 102	
	Br 5491-LBN Ne 5492-LBN Gr 5493-LBN	80W 11488 220-240V [700mA]	4000 >90 84W 8755 104	
LUCE DIRETTA + INDIRETTA - DIRECT + INDIRECT LIGHT Br 5494-LBC Ne 5495-LBC Gr 5496-LBC	DIRETTA-DIRECT INDIRETTA-INDIRECT 80W 40W 11248 5624 220-240V [700mA]	3000 >90	84W 40W 8626 4313 104	
	Br 5494-LBN Ne 5495-LBN Gr 5496-LBN	DIRETTA-DIRECT INDIRETTA-INDIRECT 80W 40W 11488 5744 220-240V [700mA]	4000 >90 84W 40W 8810 4405 107	
DIM 1-10V LUCE DIRETTA - DIRECT LIGHT Br 5491-LBC-DIM Ne 5492-LBC-DIM Gr 5493-LBC-DIM	80W 11248 220-240V [700mA]	3000 >90	84W 8572 102	
	Br 5491-LBN-DIM Ne 5492-LBN-DIM Gr 5493-LBN-DIM	80W 11488 220-240V [700mA]	4000 >90 84W 8755 104	
LUCE DIRETTA + INDIRETTA - DIRECT + INDIRECT LIGHT Br 5494-LBC-DIM Ne 5495-LBC-DIM Gr 5496-LBC-DIM	DIRETTA-DIRECT INDIRETTA-INDIRECT 80W 40W 11248 5624 220-240V [700mA]	3000 >90	84W 40W 8626 4313 104	
	Br 5494-LBN-DIM Ne 5495-LBN-DIM Gr 5496-LBN-DIM	DIRETTA-DIRECT INDIRETTA-INDIRECT 80W 40W 11488 5744 220-240V [700mA]	4000 >90 84W 40W 8810 4403 107	
SA EMERGENZA - EMERGENCY LUCE DIRETTA - DIRECT LIGHT Br 5491-LBC-EM1 Ne 5492-LBC-EM1 Gr 5493-LBC-EM1	80W 11248 220-240V [700mA]	3000 >90	84W 8572 102	
	Br 5491-LBN-EM1 Ne 5492-LBN-EM1 Gr 5493-LBN-EM1	80W 11488 220-240V [700mA]	4000 >90 84W 8755 104	

SEMPRE ACCESSO: n. 8 schede Led funzionanti per tutta la superficie dello schermo del prodotto.

EMERGENZA: n. 4 schede Led alternate funzionanti e n° 4 schede in OFF.

ALWAYS ON: n. 8 Led cards switch on for the whole screen's surface.

EMERGENCY MODE: n. 4 Led alternated cards switch on and n. 4 Led cards Switch OFF.

10.80

10.80

11.20

11.20

10.80

11.20







OP. A richiesta - On request: disponibile - available version

UGR <19

ACC. 409800 Schermo DIAMOND PRISM per versione UGR <19 - DIAMOND PRISM diffuser for UGR <19 version



	LED					SISTEMA-SYSTEM		
	W	lm	V	K	CRI	W	lm	lm/W
 DALI DIM-DALI/PUSH LUCE DIRETTA - DIRECT LIGHT Br 5491-LBC-DA Ne 5492-LBC-DA Ga 5493-LBC-DA	80W	11248	220-240V (700mA)	3000	>90	84W	8572	102
 Br 5491-LBN-DA Ne 5492-LBN-DA Ga 5493-LBN-DA	80W	114488	220-240V (700mA)	4000	>90	84W	8755	104
 LUCE DIRETTA + INDIRETTA - DIRECT + INDIRECT LIGHT Br 5494-LBC-DA Ne 5495-LBC-DA Ga 5496-LBC-DA	80W 40W	11248 5625	220-240V (700mA)	3000	>90	84W 40W	8626 4113	104
 Br 5494-LBN-DA Ne 5495-LBN-DA Ga 5496-LBN-DA	80W 40W	11488 5744	220-240V (700mA)	4000	>90	84W 40W	8810 4405	107

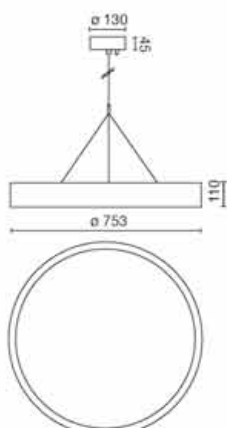





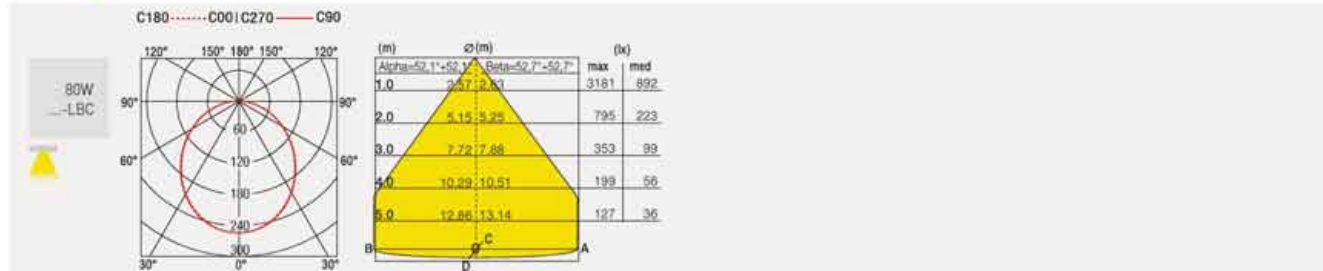

ALIMENTATORI-KIT RGB (se non in dotazione) da ordinare dalla sezione arancio - DRIVERS-RGB KITS (when not supplied) to be ordered from the section orange color



BIG SOSPENSIONE 1030

- Verniciatura per interni in polveri epossidiche.
- Pressacavo in gomma siliconica.
- Cavo alimentazione lunghezza 2 m.
- Bloccacavo termoplastico.
- Disco fissaggio e dissipazione Led in alluminio.
- Diffusore superiore in policarbonato.
- Diffusore inferiore in metacrilato bi-satinato.
- Cavetti di sospensione in acciaio con morsetto automatico.
Diametro 1,5 mm - Sezione 0,87 mmq - Portata max 25Kg - Carico di rottura 194Kg.
- Led durata utile: 50.000 (h) L70 B10.
- **UGR <19 su richiesta.**

- Indoor epoxy powder painting.
- Cable gland in silicon rubber.
- Cable length 2 m.
- Thermoplastic cable clamp.
- Aluminium fixing disk and heatsink.
- Polycarbonate upper diffuser.
- Bi-satin methacrylate diffuser.
- Steel suspension cables with automatic clamp.
Diameter 1,5 mm - Cables section 0,87 mmq - Max load 25Kg - Breaking load 194Kg.
- Led life: 50.000 (h) L70 B10.
- **UGR <19 su richiesta.**



	LED	SISTEMA-SYSTEM		
		W	lm	lm/W
ON-OFF LUCE DIRETTA - DIRECT LIGHT Br 5497-LBC Ne 5498-LBC Gr 5499-LBC	187,5W 25100	220-240V (1050mA)	3000 >90	191,5W 19128 100
Br 5497-LBN Ne 5498-LBN Gr 5499-LBN	187,5W 25520	220-240V (1050mA)	4000 >90	191,5W 19549 103
LUCE DIRETTA + INDIRETTA - DIRECT + INDIRECT LIGHT Br 5500-LBC Ne 5501-LBC Gr 5502-LBC	DIRETTA-DIRECT 187,5W 25100 INDIRETTA-INDIRECT 92W 12400	220-240V (1050mA)	3000 >90	191,5W 18870 98 92W 9220
Br 5500-LBN Ne 5501-LBN Gr 5502-LBN	DIRETTA-DIRECT 187,5W 25520 INDIRETTA-INDIRECT 92W 12600	220-240V (1050mA)	4000 >90	191,5W 18985 100 92W 9370
SA EMERGENZA - EMERGENCY LUCE DIRETTA - DIRECT LIGHT Br 5497-LBC-EM1 Ne 5498-LBC-EM1 1h Gr 5499-LBC-EM1	187,5W 25100	220-240V (1050mA)	3000 >90	191,5W 19128 100
Br 5497-LBN-EM1 Ne 5498-LBN-EM1 1h Gr 5499-LBN-EM1	187,5W 25520	220-240V (1050mA)	4000 >90	191,5W 19549 103

SEMPRE ACCESSO: n. 8 schede Led funzionanti per tutta la superficie dello schermo del prodotto.

EMERGENZA: n. 4 schede Led alternate funzionanti e n° 4 schede in OFF

ALWAYS ON: n. 8 Led cards switch on for the whole screen's surface.

EMERGENCY MODE: n. 4 Led alternated cards switch on and n. 4 Led cards Switch OFF







OP: A richiesta - On request: versioni dimmerabili 1-10V - dimmable 1-10V
disponibile - available



ACC: 409900 Schermo DIAMOND PRISM per versione UGR <19 - DIAMOND PRISM diffuser for UGR <19 version



	LED					SISTEMA-SYSTEM		
	W	lm	V	K	CRI	W	lm	IP
 <p>LUCE DIRETTA - DIRECT LIGHT</p> <p>Br 5497-LBC-DA Ne 5498-LBC-DA Ga 5499-LBC-DA</p>	187,5W	25100	220-240V (1050mA)	5000	>90	191,5W	19128	100
	 <p>Br 5497-LBN-DA Ne 5498-LBN-DA Ga 5499-LBN-DA</p>	187,5W	25200	220-240V (1050mA)	4000	>90	191,5W	19449
 <p>LUCE DIRETTA + INDIRETTA - DIRECT + INDIRECTLIGHT</p> <p>Br 5500-LBC-DA Ne 5501-LBC-DA Ga 5502-LBC-DA</p>	187,5W 92W	25100 12400	220-240V (1050mA)	5000	>90	191,5W 92W	18670 9220	98
	 <p>Br 5500-LBN-DA Ne 5501-LBN-DA Ga 5502-LBN-DA</p>	187,5W 92W	25200 12600	220-240V (1050mA)	4000	>90	191,5W 92W	18985 9370

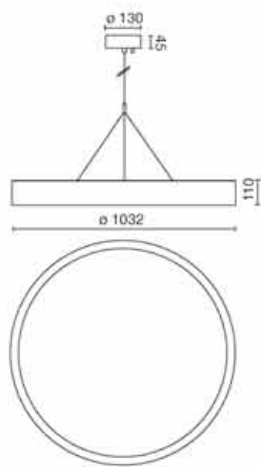









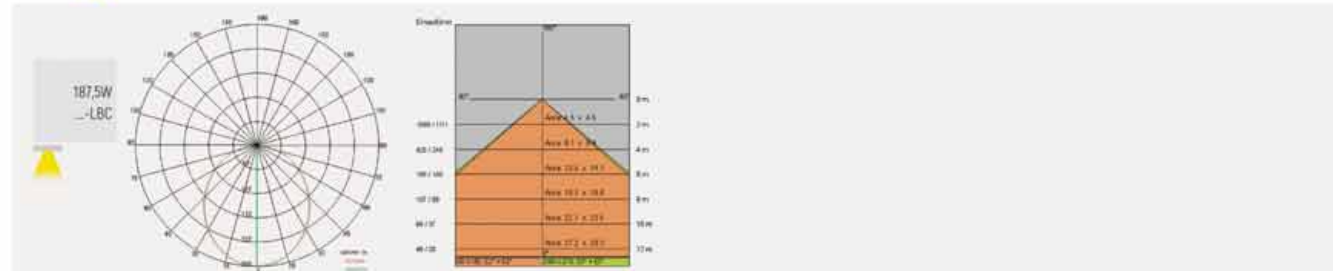

ALIMENTATORI-KIT RGB (se non in dotazione) da ordinare dalla sezione arancio - DRIVERS-RGB KITS (when not supplied) to be ordered from the section orange color

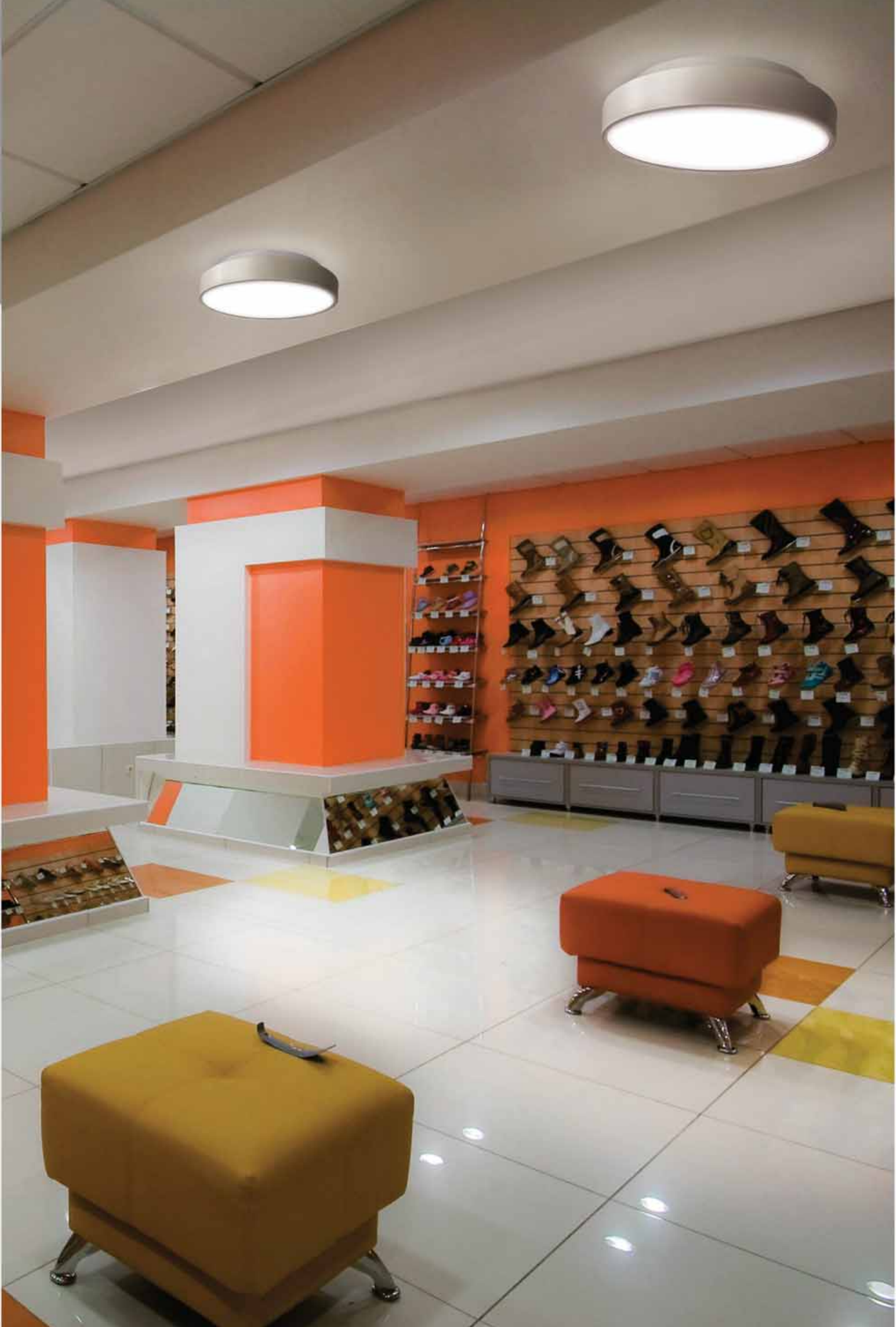

BIG FLAT PLAFONE 360-440



- Corpo in lamiera di acciaio verniciato in polveri.
- Schermo diffusore in policarbonato bi-satinato.
- Pressacavo in nylon 66.
- Luce diretta - Luce indiretta decorativa.
- Led durata utile: 50.000 (h) L70 B10.

- Body made of powder coated sheet steel.
- Bi-satin polycarbonate diffuser.
- Cable gland in nylon 66.
- Direct and decorative indirect light.
- Led life: 50.000 (h) L70 B10.

	LED	SISTEMA-SYSTEM										
		W	lm	V	K	CRI	W	lm	lm			
	BIG FLAT 360											
	Br 5525-LBC	27W	4000	220-240V	3000	>90	31W	2425	78			
	Ne 5526-LBC			(500mA)								
	Gr 5527-LBC											
	Br 5525-LBN	27W	4200	220-240V	4000	>90	31W	2547	82			
	Ne 5526-LBN			(500mA)								
	Gr 5527-LBN											
	DIMM 1-10V											
	Br 5525-LBC-DIM	27W	4000	220-240V	3000	>90	31W	2425	78			
	Ne 5526-LBC-DIM			(500mA)								
	Gr 5527-LBC-DIM											
		BIG FLAT 440										
Br 5565-LBC		34W	3540	220-240V	3000	>90	38W	2147	56			
Ne 5566-LBC				(700mA)								
Gr 5567-LBC												
Br 5565-LBN		34W	3725	220-240V	4000	>90	38W	2255	59			
Ne 5566-LBN				(700mA)								
Gr 5567-LBN												
DIMM 1-10V												
Br 5565-LBC-DIM		34W	3540	220-240V	3000	>90	38W	2147	56			
Ne 5566-LBC-DIM				(700mA)								
Gr 5567-LBC-DIM												
		DALI DIM-DALI/PUSH										
	Br 5525-LBC-DA	27W	4000	220-240V	3000	>90	31W	2425	78			
	Ne 5526-LBC-DA			(500mA)								
	Gr 5527-LBC-DA											
	Br 5525-LBN-DA	27W	4200	220-240V	4000	>90	31W	2547	82			
	Ne 5526-LBN-DA			(500mA)								
	Gr 5527-LBN-DA											
	DALI DIM-DALI/PUSH											
	Br 5565-LBC-DA	34W	3540	220-240V	3000	>90	38W	2147	56			
	Ne 5566-LBC-DA			(700mA)								
	Gr 5567-LBC-DA											
	Br 5565-LBN-DA	34W	3725	220-240V	4000	>90	38W	2255	59			
Ne 5566-LBN-DA			(700mA)									
Gr 5567-LBN-DA												

ACC. 409700 Schermo DIAMOND PRISM per versione UGR <19 - DIAMOND PRISM diffuser for UGR <19 version - BIG FLAT 360
 409995 Schermo DIAMOND PRISM per versione UGR <19 - DIAMOND PRISM diffuser for UGR <19 version - BIG FLAT 440

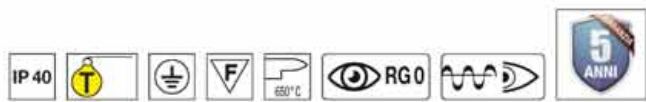
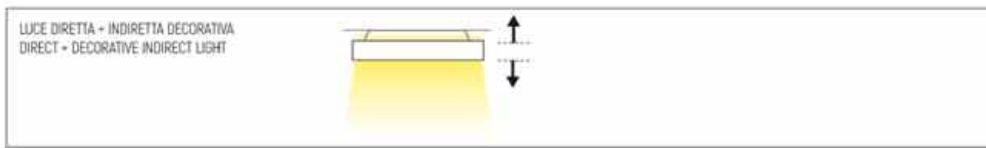

ALIMENTATORI-KIT RGB (se non in dotazione) da ordinare dalla sezione arancio - DRIVERS-RGB KITS (when not supplied) to be ordered from the section orange color

PARETE - PLAFONE - SOSPENSIONI • WALL - CEILING - SUSPENSION



BIG FLAT PLAFONE 550

- Corpo in lamiera di acciaio verniciato in polveri.
- Schermo diffusore in policarbonato bi-satinato.
- Pressacavo in nylon 66.
- Luce diretta - Luce indiretta decorativa.
- Led durata utile: 50.000 (h) L70 B10.

- Body made of sheet steel.
- Bi-satin polycarbonate diffuser.
- Cable gland in nylon 66.
- Direct and decorative indirect light.
- Led life: 50.000 (h) L70 B10.



	Br	Ne	Gr	LED			SYSTEM-SYSTEM				
				W	lm	V	K	(CRI)	W	lm	(W)
	5535-LBC	5536-LBC	5537-LBC	51W	6800	220-240V [700mA]	3000	>90	55W	4003	73
	5535-LBN	5536-LBN	5537-LBN	51W	6828	220-240V [700mA]	4000	>90	55W	4202	76
	DIMM 1-10V			51W	6800	220-240V [700mA]	3000	>90	55W	4003	73
	5535-LBN-DIM	5536-LBN-DIM	5537-LBN-DIM	51W	6828	220-240V [700mA]	4000	>90	55W	4202	76
	DIM-DALI/PUSH			51W	6800	220-240V [700mA]	3000	>90	55W	4003	73
	5535-LBN-DA	5536-LBN-DA	5537-LBN-DA	51W	6828	220-240V [700mA]	4000	>90	55W	4202	76

ACC. 409500 Schermo DIAMOND PRISM per versione UGR <19 - DIAMOND PRISM diffuser for UGR <19 version

LUCE DIRETTA + INDIRETTA DECORATIVA
DIRECT + DECORATIVE INDIRECT LIGHT

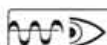

BIG FLAT PLAFONE 750



- Corpo in lamiera di acciaio verniciato in polveri.
- Schermo diffusore in policarbonato bi-satinato.
- Pressacavo in nylon 66.
- Luce diretta - Luce indiretta decorativa.
- Led durata utile: 50.000 (h) L70 B10.

- Body made of sheet steel.
- Bi-satin polycarbonate diffuser.
- Cable gland in nylon 66.
- Direct and decorative indirect light.
- Led life: 50.000 (h) L70 B10.



	Br	Ne	Gr	LED			SISTEMA-SYSTEM												
				W	lm	V	K	CRI	W	lm	W								
	5555-LBC	5556-LBC	5557-LBC	80W	11248	220-240V [700mA]	3000	>90	84W	6822	81								
	5555-LBN	5556-LBN	5557-LBN									80W	11488	220-240V [700mA]	4000	>90	84W	6967	83
	5555-LBC-DIM	5556-LBC-DIM	5557-LBC-DIM																
5555-LBN-DIM	5556-LBN-DIM	5557-LBN-DIM	80W	11488	220-240V [700mA]	4000	>90	84W	6967	83									
DIM-DALI/PUSH											80W	11248	220-240V [700mA]	3000	>90	84W	6822	81	
5555-LBC-DA	5556-LBC-DA	5557-LBC-DA																	80W
5555-LBN-DA	5556-LBN-DA	5557-LBN-DA	80W	11488	220-240V [700mA]	4000	>90	84W	6967	83									

ACC. 409800 Schermo DIAMOND PRISM per versione UGR <19 - DIAMOND PRISM diffuser for UGR <19 version

LUCE DIRETTA - INDIRETTA DECORATIVA
DIRECT - DECORATIVE INDIRECT LIGHT





BIG FLAT SOSPENSIONE 360-440



- Corpo in lamiera di acciaio verniciato in polveri.
- Schermo diffusore in policarbonato bi-satinato.
- Pressacavo in nylon 66.
- Luce diretta - Luce indiretta decorativa.
- Led durata utile: 50.000 (h) L70 B10.

- Body made of powder coated sheet steel.
- Bi-satin polycarbonate diffuser.
- Cable gland in nylon 66.
- Direct and decorative indirect light.
- Led life: 50.000 (h) L70 B10.



	LED	SISTEMA-SYSTEM					
		W	lm	lm/W			
	BIG FLAT 360						
	Br 5525-LBC-S	27W	4000	220-240V (500mA)	31W	2425	78
	Ne 5526-LBC-S						
	Gr 5527-LBC-S						
	Br 5525-LBN-S	27W	4200	220-240V (500mA)	31W	2547	82
	Ne 5526-LBN-S						
	Gr 5527-LBN-S						
	DIMM 1-10V						
	Br 5525-LBC-DIM-S	27W	4000	220-240V (500mA)	31W	2425	78
	Ne 5526-LBC-DIM-S						
	Gr 5527-LBC-DIM-S						
	Br 5525-LBN-DIM-S	27W	4200	220-240V (500mA)	31W	2547	82
Ne 5526-LBN-DIM-S							
Gr 5527-LBN-DIM-S							
DALI DIM-DALI/PUSH							
Br 5525-LBC-DA-S	27W	4000	220-240V (500mA)	31W	2425	78	
Ne 5526-LBC-DA-S							
Gr 5527-LBC-DA-S							
Br 5525-LBN-DA-S	27W	4200	220-240V (500mA)	31W	2547	82	
Ne 5526-LBN-DA-S							
Gr 5527-LBN-DA-S							
	BIG FLAT 440						
	Br 5565-LBC-S	34W	3540	220-240V (700mA)	38W	2147	58
	Ne 5566-LBC-S						
	Gr 5567-LBC-S						
	Br 5565-LBN-S	34W	3724	220-240V (700mA)	38W	2255	59
	Ne 5566-LBN-S						
	Gr 5567-LBN-S						
	DIM 1-10V						
	Br 5565LBC-DIM-S	34W	3540	220-240V (700mA)	38W	2147	58
	Ne 5566LBC-DIM-S						
	Gr 5567LBC-DIM-S						
	Br 5565LBN-DIM-S	34W	3724	220-240V (700mA)	38W	2255	59
Ne 5566LBN-DIM-S							
Gr 5567LBN-DIM-S							
DALI DIM-DALI/PUSH							
Br 5565-LBC-DA-S	34W	3540	220-240V (700mA)	36W	2147	58	
Ne 5566-LBC-DA-S							
Gr 5567-LBC-DA-S							
Br 5565-LBN-DA-S	34W	3724	220-240V (700mA)	36W	2255	59	
Ne 5566-LBN-DA-S							
Gr 5567-LBN-DA-S							

ACC. 409700 Schermo DIAMOND PRISM per versione UGR <19 - DIAMOND PRISM diffuser for UGR <19 version - **BIG FLAT 360**
 409995 Schermo DIAMOND PRISM per versione UGR <19 - DIAMOND PRISM diffuser for UGR <19 version - **BIG FLAT 440**

LUCE DIRETTA - INDIRETTA DECORATIVA
 DIRECT - DECORATIVE INDIRECT LIGHT



*Solo con accessorio - Only with accessory



ALIMENTATORI-KIT RGB (se non in dotazione) da ordinare dalla sezione arancio - DRIVERS-RGB KITS (when not supplied) to be ordered from the section orange color





BIG FLAT SOSPENSIONE 550

- Corpo in lamiera di acciaio verniciato in polveri.
- Schermo diffusore in policarbonato bi-satinato.
- Pressacavo in nylon 66.
- Luce diretta - Luce indiretta decorativa.
- Sospensioni con funi in acciaio L. 2100 mm.
- Led durata utile: 50.000 (h) L70 B10.

- Body made of sheet steel.
- Bi-satin polycarbonate diffuser.
- Cable gland in nylon 66.
- Direct and indirect decorative light.
- Suspension with steel cables L. 2100 mm.
- Led life: 50.000 (h) L70 B10.



		LED					SISTEMA-SYSTEM			
		W	lm	V	K	CRI	W	lm	UGR	
	Br	5535-LBC-S								
	Ne	5536-LBC-S	51W	6600	220-240V (700mA)	3000	>90	55W	4003	73
	Gr	5537-LBC-S								
	Br	5535-LBN-S								
	Ne	5536-LBN-S	51W	6928	220-240V (700mA)	4000	>90	55W	4202	76
	Gr	5537-LBN-S								
	DIM 1-10V									
	Br	5535LBC-DIM-S	51W	6600	220-240V (700mA)	3000	>90	55W	4003	73
	Ne	5536LBC-DIM-S								
	Br	5535LBN-DIM-S	51W	6928	220-240V (700mA)	4000	>90	55W	4202	76
	Ne	5536LBN-DIM-S								
	Gr	5537LBN-DIM-S								
	DALI DIM-DALI/PUSH									
	Br	5535-LBC-DA-S	51W	6600	220-240V (700mA)	3000	>90	55W	4003	73
	Ne	5536-LBC-DA-S								
	Br	5535-LBN-DA-S	51W	6928	220-240V (700mA)	4000	>90	55W	4202	76
	Ne	5536-LBN-DA-S								
	Gr	5537-LBN-DA-S								

ACC. 409500 Schermo DIAMOND PRISM per versione UGR <19 - DIAMOND PRISM diffusor for UGR <19 version

LUCE DIRETTA + INDIRETTA DECORATIVA
DIRECT + DECORATIVE INDIRECT LIGHT



-Solo con accessorio - Only with accessory

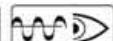

inside

ALIMENTATORI-KIT RGB (se non in dotazione) da ordinare dalla sezione arancio - DRIVERS-RGB KITS (when not supplied) to be ordered from the section orange color

BIG FLAT SOSPENSIONE 750



- Corpo in lamiera di acciaio verniciato in polveri.
- Schermo diffusore in policarbonato bi-satinato.
- Pressacavo in nylon 66.
- Luce diretta - Luce indiretta decorativa.
- Sospensioni con funi in acciaio L. 2100 mm.
- Led durata utile: 50.000 (h) L70 B10.

- Body made of powder coated sheet steel.
- Bi-satin polycarbonate diffuser.
- Cable gland in nylon 66.
- Direct and indirect decorative light.
- Suspension with steel cables L. 2100 mm.
- Led life: 50.000 (h) L70 B10.



	Br	Ne	Gr	LED					SISTEMA-SYSTEM		
				W	lm	V	K	CRI	W	lm	lm/W
	5555-LBC-S	5556-LBC-S	5557-LBC-S	80W	11248	220-240V [700mA]	3000	>90	84W	6822	81
	5555-LBN-S	5556-LBN-S	5557-LBN-S	80W	11488	220-240V [700mA]	4000	>90	84W	6967	83
	DIM 1-10V										
	5555LBC-DIM-S	5556LBC-DIM-S	5557LBC-DIM-S	80W	11248	220-240V [700mA]	3000	>90	84W	6822	81
	5555LBN-DIM-S	5556LBN-DIM-S	5557LBN-DIM-S	80W	11488	220-240V [700mA]	4000	>90	84W	6967	83
	DALI DIM-DALI/PUSH										
	5555-LBC-DA-S	5556-LBC-DA-S	5557-LBC-DA-S	80W	11248	220-240V [700mA]	3000	>90	84W	6822	81
	5555-LBN-DA-S	5556-LBN-DA-S	5557-LBN-DA-S	80W	11488	220-240V [700mA]	4000	>90	84W	6967	83

ACC. 409800 Schermo DIAMOND PRISM per versione UGR <19 - DIAMOND PRISM diffuser for UGR <19 version

LUCE DIRETTA + INDIRETTA DECORATIVA
DIRECT + DECORATIVE INDIRECT LIGHT

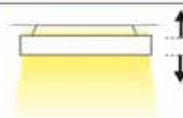

-Solo con accessorio - Only with accessory



ALIMENTATORI-KIT RGB (se non in dotazione) da ordinare dalla sezione arancio - DRIVERS-RGB KITS (when not supplied) to be ordered from the section orange color







STARGATE 550 ECO



- Corpo in lamiera di acciaio.
 - Schermo diffusore in policarbonato bisatinato lucido.
 - Verniciatura in polveri di poliestere.
 - Pressacavo in nylon 66.
 - Sospensioni con funi in acciaio L. 2100 mm.
 - Luce diretta - Luce indiretta.
 - Led durata utile: 50.000 (h) L80 B20.
- Body in steel sheet.
 - Glossy satin polycarbonate diffuser.
 - Polyester powder painting.
 - Nylon 66 cable gland.
 - Suspension with steel cables L. 2100 mm.
 - Direct and indirect light.
 - Led life: 50.000 (h) L80 B20.

	ON-OFF	LED					SISTEMA-SYSTEM		
		W	lm	V	K	CR	W	lm	SP
	LUCE DIRETTA+INDIRETTA - DIRECT+INDIRECT LIGHT Br 5600-LBC2 Ne 5601-LBC2 Gr 5602-LBC2	48W	7200	220-240V [500mA]	3000	>80	51W	4316	85
	Br 5600-LBN2 Ne 5601-LBN2 Gr 5602-LBN2	48W	7840	220-240V [500mA]	4000	>80	51W	4700	92
	DIM 1+10V/PUSH LUCE DIRETTA+INDIRETTA - DIRECT+INDIRECT LIGHT Br 5600-LBC-DIM2 Ne 5601-LBC-DIM2 Gr 5602-LBC-DIM2	48W	7200	220-240V [500mA]	3000	>80	51W	4316	85
	Br 5600-LBN-DIM2 Ne 5601-LBN-DIM2 Gr 5602-LBN-DIM2	48W	7840	220-240V [500mA]	4000	>80	51W	4700	92
	SA EMERGENZA - EMERGENCY LUCE DIRETTA+INDIRETTA - DIRECT+INDIRECT LIGHT Br 5600-LBC-EM2 Ne 5601-LBC-EM2 1h Gr 5602-LBC-EM2	48W	7200	220-240V [500mA]	3000	>80	51W	4316	85
	Br 5600-LBN-EM2 Ne 5601-LBN-EM2 1h Gr 5602-LBN-EM2	48W	7840	220-240V [500mA]	4000	>80	51W	4700	92
	DALI DIM-DALI/PUSH LUCE DIRETTA+INDIRETTA - DIRECT+INDIRECT LIGHT Br 5600-LBC-DA2 Ne 5601-LBC-DA2 Gr 5602-LBC-DA2	48W	7200	220-240V [500mA]	3000	>80	51W	4316	85
	Br 5600-LBN-DA2 Ne 5601-LBN-DA2 Gr 5602-LBN-DA2	48W	7840	220-240V [500mA]	4000	>80	51W	4700	92



ALIMENTATORI-KIT RGB (se non in dotazione) da ordinare dalla sezione arancio - DRIVERS-RGB KITS (when not supplied) to be ordered from the section orange color



STARGATE 750 ECO



- Corpo in lamiera di acciaio.
- Schermo diffusore in policarbonato bisatinato lucido.
- Verniciatura in polveri di poliestere.
- Pressacavo in nylon 66.
- Sospensioni con funi in acciaio L. 2100 mm.
- Luce diretta - Luce indiretta.
- Led durata utile: 50.000 (h) L80 B20.

- Body in steel sheet.
- Glossy satin polycarbonate diffuser.
- Polyester powder painting.
- Nylon 66 cable gland.
- Suspension with steel cables L. 2100 mm.
- Direct and indirect light.
- Led life: 50.000 (h) L80 B20.



			LED					SISTEMA-SYSTEM			
			W	lm	V	K	CRI	W	lm	W	
	ON-OFF LUCE DIRETTA+INDIRETTA - DIRECT+INDIRECT LIGHT A= 233mm	Br 5605-LBC2	66W	10400	220-240V (700mA)	3000	>80	70W	6225	89	
		Ne 5606-LBC2									
	Gr 5607-LBC2										
	Br 5605-LBN2 Ne 5606-LBN2 Gr 5607-LBN2	DIM 1-10V/PUSH LUCE DIRETTA+INDIRETTA - DIRECT+INDIRECT LIGHT A= 233mm	Br 5605-LBC-DIM2	66W	10400	220-240V (700mA)	3000	>80	70W	6225	89
			Ne 5606-LBC-DIM2								
	Gr 5607-LBC-DIM2										
Br 5605-LBN-DIM2 Ne 5606-LBN-DIM2 Gr 5607-LBN-DIM2	SA EMERGENZA - EMERGENCY LUCE DIRETTA+INDIRETTA - DIRECT+INDIRECT LIGHT A= 283mm	Br 5605-LBC-EM2	66W	10400	220-240V (700mA)	3000	>80	70W	6225	89	
		Ne 5606-LBC-EM2 1h									
Gr 5607-LBC-EM2											
Br 5605-LBN-EM2 Ne 5606-LBN-EM2 1h Gr 5607-LBN-EM2	DALI DIM-DALI/PUSH LUCE DIRETTA+INDIRETTA - DIRECT+INDIRECT LIGHT A= 233mm	Br 5605-LBC-DA2	66W	10400	220-240V (700mA)	3000	>80	70W	6225	89	
		Ne 5606-LBC-DA2									
Gr 5607-LBC-DA2											
Br 5605-LBN-DA2 Ne 5606-LBN-DA2 Gr 5607-LBN-DA2											

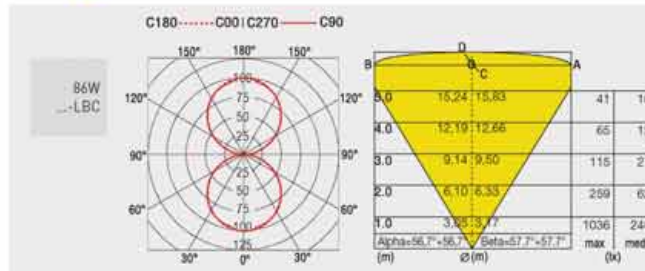

ALIMENTATORI-KIT RGB (se non in dotazione) da ordinare dalla sezione arancio - DRIVERS-RGB KITS (when not supplied) to be ordered from the section orange color

PARETE - PLAFONE - SOSPENSIONI • WALL - CEILING - SUSPENSION





STARGATE 950 ECO

- Corpo in lamiera di acciaio.
- Schermo diffusore in policarbonato bisatinato lucido diviso in 3 settori.
- Verniciatura in polveri di poliestere.
- Pressacavo in nylon 66.
- Sospensioni con funi in acciaio L. 2100 mm.
- Luce diretta - Luce indiretta.
- Led durata utile: 50.000 (h) L80 B20.

- Body in steel sheet.
- Glossy satin polycarbonate diffuser divided into 3 sectors.
- Polyester powder painting.
- Nylon 66 cable gland.
- Suspension with steel cables L. 2100 mm.
- Direct and indirect light.
- Led life: 50.000 (h) L70 B10.



	LED		SISTEMA-SYSTEM							
	W	lm	V	K	CRI	W	lm	lm/W		
	ON-OFF LUCE DIRETTA+INDIRETTA - DIRECT+INDIRECT LIGHT									
	Br	5610-LBC3	86W	12960	220-240V [650mA]	3000	>80	92W	7770	84
	Ne	5611-LBC3								
Gr	5612-LBC3									
	Br	5610-LBN3	86W	14160	220-240V [650mA]	4000	>80	92W	8500	92
	Ne	5611-LBN3								
	Gr	5612-LBN3								
	DIM 1+10V/PUSH									
	Br	5610-LBC-DIM3	86W	12960	220-240V [650mA]	3000	>80	92W	7770	84
	Ne	5611-LBC-DIM3								
Gr	5612-LBC-DIM3									
	Br	5610-LBN-DIM3	86W	14160	220-240V [650mA]	4000	>80	92W	8500	92
	Ne	5611-LBN-DIM3								
	Gr	5612-LBN-DIM3								
	DIM-DALI/PUSH									
	Br	5610-LBC-DA3	86W	12960	220-240V [650mA]	3000	>80	92W	7770	84
	Ne	5611-LBC-DA3								
Gr	5612-LBC-DA3									
	Br	5610-LBN-DA3	86W	14160	220-240V [650mA]	4000	>80	92W	8500	92
	Ne	5611-LBN-DA3								
	Gr	5612-LBN-DA3								

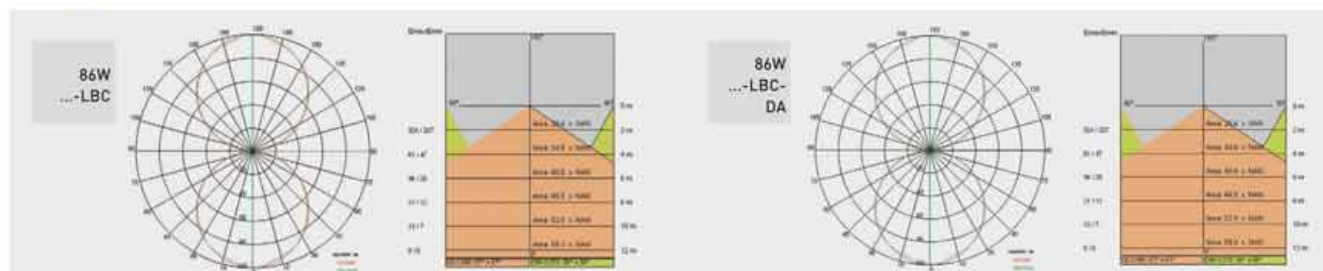

ALIMENTATORI-KIT RGB (se non in dotazione) da ordinare dalla sezione arancio - DRIVERS-RGB KITS (when not supplied) to be ordered from the section orange color

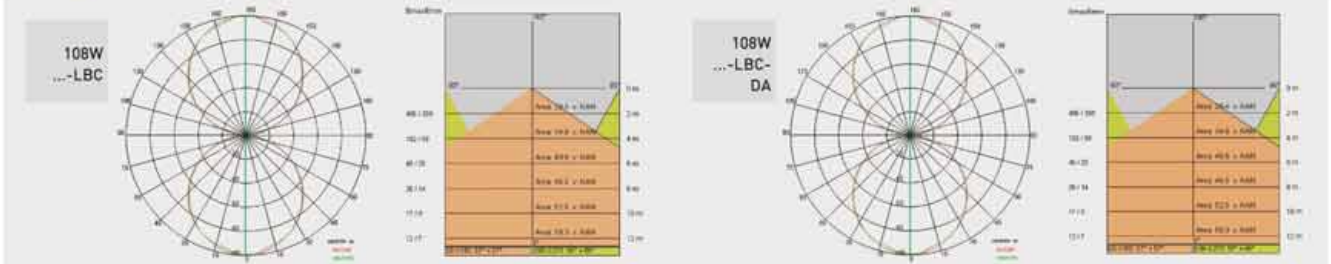

ALIMENTATORI-KIT RGB (se non in dotazione) da ordinare dalla sezione arancio - DRIVERS-RGB KITS (when not supplied) to be ordered from the section orange color



- Corpo in lamiera di acciaio.
- Schermo diffusore in policarbonato bisatinato lucido diviso in 4 settori.
- Verniciatura in polveri di poliestere.
- Pressacavo in nylon 66.
- Sospensioni con funi in acciaio L. 2100 mm.
- Luce diretta - Luce indiretta.
- Led durata utile: 50.000 (h) L70 B10.

- Body in steel sheet.
- Glossy satin polycarbonate diffuser divided into 4 sectors.
- Polyester powder painting.
- Nylon 66 cable gland.
- Suspension with steel cables L. 2100 mm.
- Direct and indirect light.
- Led life: 50.000 (h) L70 B10.

STARGATE 1250 ECO



	LED					SISTEMA-SYSTEM			
	W	lm	V	K	CRI	W	lm	lm/W	
	ON-OFF								
	LUCE DIRETTA/INDIRETTA - DIRECT/INDIRECT LIGHT								
	Br	5615-LBC4	108W	16200	220-240V [500mA]	3000	>80	112W	9712 87
	Ne	5616-LBC4							
	Gr	5617-LBC4							
	Br	5615-LBN4	108W	17280	220-240V [500mA]	4000	>80	112W	10360 93
	Ne	5616-LBN4							
	Gr	5617-LBN4							
	DIM 1+10V/PUSH								
	LUCE DIRETTA/INDIRETTA - DIRECT/INDIRECT LIGHT								
	Br	5615-LBC-DIM4	108W	16200	220-240V [500mA]	3000	>80	112W	9712 87
	Ne	5616-LBC-DIM4							
	Gr	5617-LBC-DIM4							
	Br	5615-LBN-DIM4	108W	17280	220-240V [500mA]	4000	>80	112W	10360 93
	Ne	5616-LBN-DIM4							
	Gr	5617-LBN-DIM4							
	DALI DIM-DALI/PUS								
	LUCE DIRETTA/INDIRETTA - DIRECT/INDIRECT LIGHT								
	Br	5615-LBC-DA4	108W	16200	220-240V [500mA]	3000	>80	112W	9712 87
	Ne	5616-LBC-DA4							
	Gr	5617-LBC-DA4							
	Br	5615-LBN-DA4	108W	17280	220-240V [500mA]	4000	>80	112W	10360 93
	Ne	5616-LBN-DA4							
	Gr	5617-LBN-DA4							
	ON-OFF								
	LUCE DIRETTA - DIRECT LIGHT								
	Br	5620-LBC4	54W	8100	220-240V [500mA]	3000	>80	58W	4694 81
	Ne	5621-LBC4							
	Gr	5622-LBC4							
	Br	5620-LBN4	54W	8640	220-240V [500mA]	4000	>80	58W	5007 86
	Ne	5621-LBN4							
	Gr	5622-LBN4							
	DIM 1+10V/PUSH								
	LUCE DIRETTA - DIRECT LIGHT								
	Br	5620-LBC-DIM4	54W	8100	220-240V [500mA]	3000	>80	58W	4694 81
	Ne	5621-LBC-DIM4							
	Gr	5622-LBC-DIM4							
	Br	5620-LBN-DIM4	54W	8640	220-240V [500mA]	4000	>80	58W	5007 86
	Ne	5621-LBN-DIM4							
	Gr	5622-LBN-DIM4							
	DALI DIM-DALI/PUS								
	LUCE DIRETTA - DIRECT LIGHT								
	Br	5620-LBC-DA4	54W	8100	220-240V [500mA]	3000	>80	58W	4694 81
	Ne	5621-LBC-DA4							
	Gr	5622-LBC-DA4							
	Br	5620-LBN-DA4	54W	8640	220-240V [500mA]	4000	>80	58W	5007 86
	Ne	5621-LBN-DA4							
	Gr	5622-LBN-DA4							



STARGATE 2000

- Corpo in lamiera di acciaio.
- Schermo diffusore in policarbonato bisatinato lucido.
- Verniciatura in polveri di poliestere.
- Pressacavo in nylon 66.
- Sospensioni con funi in acciaio L. 2100 mm.
- Luce diretta - Luce indiretta.
- Led durata utile: 50.000 (h) L80 B10.
- N. 8 funi di sospensione in acciaio: sezione 1,5 mm. x 19 fili
Formazione 1 (12+6+1)
- Carico snervamento 1900 N, carico rottura 194 Kg a fune.
- Rosone con driver.

- Steel sheet body.
- Glossy satin polycarbonate diffuser.
- Polyester powder painting.
- Nylon 66 cable gland.
- Suspension with steel cables L. 2100 mm.
- Direct and indirect light.
- Led life: 50.000 (h) L80 B10.
- N. 8 suspension steel cables- section 1,5mm.
- Breaking charge 1900 N breaking load 194 kgs for cable.
- Canopy with driver included.

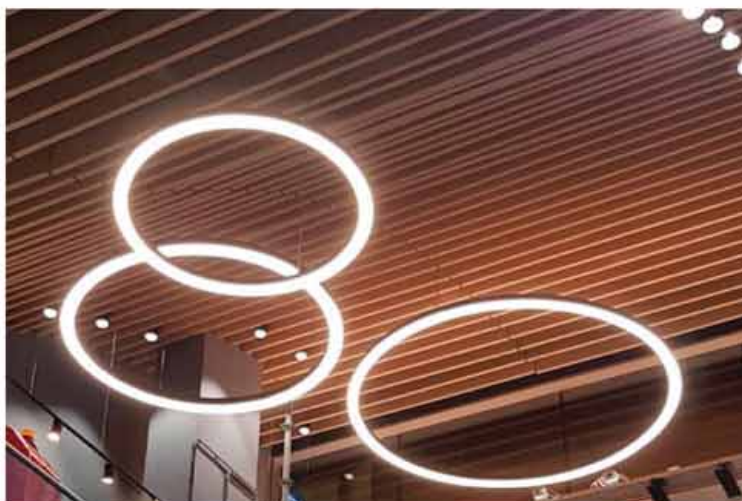

	LED					SISTEMA-SYSTEM			
	W	lm	V	K	CRI	W	lm	lm/W	
	LUCE DIRETTA - DIRECT LIGHT								
	Br 5625-LBC								
	Ne 5626-LBC	116W	14160	220-240V 24V	3000	>80	120W	9480	79
	Gr 5627-LBC								
	LUCE DIRETTA + INDIRETTA DIRECT + INDIRECT LIGHT								
	Br 5625-LBN								
	Ne 5626-LBN	116W	14160	220-240V 24V	4000	>80	120W	9480	79
	Gr 5627-LBN								
	DALI DIM-DALI/PUSH								
	Br 5625-LBC-DA								
	Ne 5626-LBC-DA	116W	14160	220-240V 24V	3000	>80	120W	9480	79
	Gr 5627-LBC-DA								
Br 5625-LBN-DA									
Ne 5626-LBN-DA	116W	14160	220-240V 24V	4000	>80	120W	9480	79	
Gr 5627-LBN-DA									
LUCE DIRETTA + INDIRETTA DIRECT + INDIRECT LIGHT									
Br 5630-LBC									
Ne 5631-LBC	174W	14160+ 7080	220-240V 24V	3000	>80	178W	9450- 4725	80	
Gr 5632-LBC									
DALI DIM-DALI/PUSH									
Br 5630-LBN									
Ne 5631-LBN	174W	14160+ 7080	220-240V 24V	4000	>80	178W	9450- 4725	80	
Gr 5632-LBN									
DALI DIM-DALI/PUSH									
Br 5630-LBC-DA									
Ne 5631-LBC-DA	174W	14160+ 7080	220-240V 24V	3000	>80	178W	9450- 4725	80	
Gr 5632-LBC-DA									
Br 5630-LBN-DA									
Ne 5631-LBN-DA	174W	14160+ 7080	220-240V 24V	4000	>80	178W	9450- 4725	80	
Gr 5632-LBN-DA									



STARGATE 3000



- Corpo in lamiera di acciaio.
- Schermo diffusore in policarbonato bisatinato lucido.
- Verniciatura in polveri di poliester.
- Pressacavo in nylon 66.
- Sospensioni con funi in acciaio L. 2100 mm.
- Luce diretta - Luce indiretta.
- Led durata utile: 50.000 (h) L80 B10.
- N. 8 funi di sospensione in acciaio: sezione 1,5 mm. x 19 fili
Formazione 1 (12+6+1)
- Carico snervamento 1900 N, carico rottura 194 Kg a fune.
- Rosone con driver.

- Steel sheet body.
- Glossy satin polycarbonate diffuser.
- Polyester powder painting.
- Nylon 66 cable gland.
- Suspension with steel cables L. 2100 mm.
- Direct and indirect light.
- Led life: 50.000 (h) L80 B10.
- N. 8 suspension steel cables- section 1,5mm.
- Breaking charge 1900 N breaking load 194 kgs for cable.
- Canopy with driver included.



	LED					SISTEMA-SYSTEM		
	W	lm	V	K	CRI	W	lm	kg
	LUCE DIRETTA - DIRECT LIGHT Br 5635-LBC Ne 5636-LBC Gr 5637-LBC							
	176W	21000	220-240V 24V	3000	>80	180W	14061	78
	Br 5635-LBN Ne 5636-LBN Gr 5637-LBN							
	176W	21000	220-240V 24V	4000	>80	180W	14061	78
	DALI DIM-DALI/PUSH Br 5635-LBC-DA Ne 5636-LBC-DA Gr 5637-LBC-DA							
	176W	21000	220-240V 24V	3000	>80	180W	14061	78
	Br 5635-LBN-DA Ne 5636-LBN-DA Gr 5637-LBN-DA							
	176W	21000	220-240V 24V	4000	>80	180W	14061	78
	LUCE DIRETTA + INDIRETTA DIRECT + INDIRECT LIGHT Br 5640-LBC Ne 5641-LBC Gr 5642-LBC							
	266W	21000+ 10500	220-240V 24V	3000	>80	270W	14061+ 6965	78
	Br 5640-LBN Ne 5641-LBN Gr 5642-LBN							
	266W	21000+ 10500	220-240V 24V	4000	>80	270W	14061+ 6965	78
DALI DIM-DALI/PUSH Br 5640-LBC-DA Ne 5641-LBC-DA Gr 5642-LBC-DA								
266W	21000+ 10500	220-240V 24V	3000	>80	270W	14061+ 6965	78	
Br 5640-LBN-DA Ne 5641-LBN-DA Gr 5642-LBN-DA								
266W	21000+ 10500	220-240V 24V	4000	>80	270W	14061+ 6965	78	



ALIMENTATORI-KIT RGB (se non in dotazione) da ordinare dalla sezione arancio - DRIVERS-RGB KITS (when not supplied) to be ordered from the section orange color





AURORA XS



- Corpo in alluminio e struttura interna in acciaio verniciati con polveri epossidiche.
- Vano ottico in pressofusione verniciato in polveri.
- Gruppo di alimentazione integrato.
- Cavo di alimentazione lunghezza 2 m.
- Parabola sfaccettata in alluminio purissimo.
- Raffreddamento Led passivo.
- Vetro di protezione.
- Led durata utile: 50.000 (h).
- Consistenza cromatica: <3 MCE.

- Body made of aluminium and steel, powder coated.
- Optic tray made of die-cast aluminium powder coated.
- Built-in power supply unit.
- Power cable length 2 m.
- Reflector in pure aluminium.
- Passive heatsink.
- Protection glass.
- Led life: 50.000 (h).
- Chromatic consistency: <3 MCE.



	Br	Ne	Ga	LED					SISTEMA-SYSTEM					
				W	lm	V	K	CRI	W	lm	lm/W			
	5401-LBC-30	5401-LBC-60		57W	4740	220-240V (1050mA)	3000	>90	41W	4230	103	(30°)		
	5402-LBC-30	5402-LBC-60							4180	102	(60°)			
	5403-LBC-30	5403-LBC-60												
	5401-LBN-30	5401-LBN-60		57W	4970	220-240V (1050mA)	4000	>90	41W	4435	108	(30°)		
	5402-LBN-30	5402-LBN-60							4375	107	(60°)			
	5403-LBN-30	5403-LBN-60												
	DALI DIM-DALI/PUSH													
	5401LBC30-DA	5401LBC60-DA		57W	4740	220-240V (1050mA)	3000	>90	41W	4230	103	(30°)		
	5402LBC30-DA	5402LBC60-DA							4180	102	(60°)			
	5403LBC30-DA	5403LBC60-DA												
	5401LBN30-DA	5401LBN60-DA		57W	4970	220-240V (1050mA)	4000	>90	41W	4315	108	(30°)		
	5402LBN30-DA	5402LBN60-DA							4375	107	(60°)			
	5403LBN30-DA	5403LBN60-DA												

DR. A richiesta - On request: Adattatore per binario SITRACK - SITRACK adaptor
Led con temperatura di colore 2700K - Temperature Led colour 2700K

ACC. A richiesta - On request: vetro sabbato - On request: frosted glass

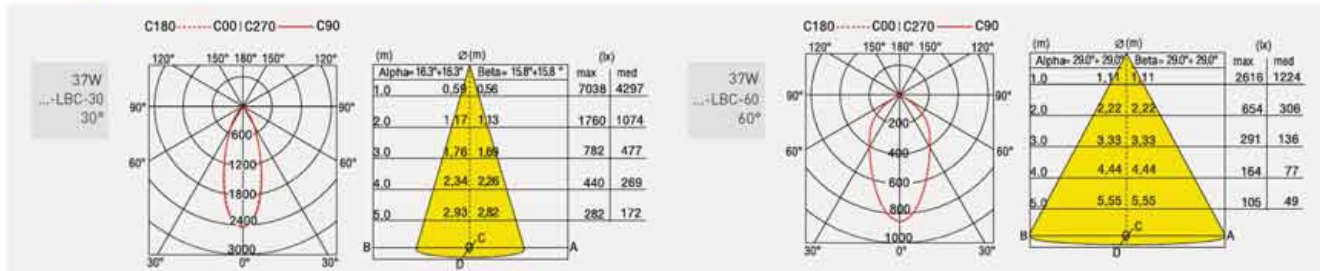
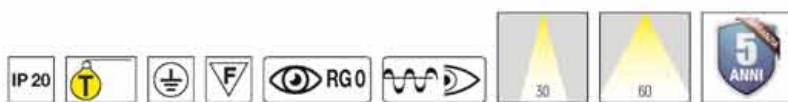

ALIMENTATORI-KIT RGB (se non in dotazione) da ordinare dalla sezione arancio - DRIVERS-RGB KITS (when not supplied) to be ordered from the section orange color



inside

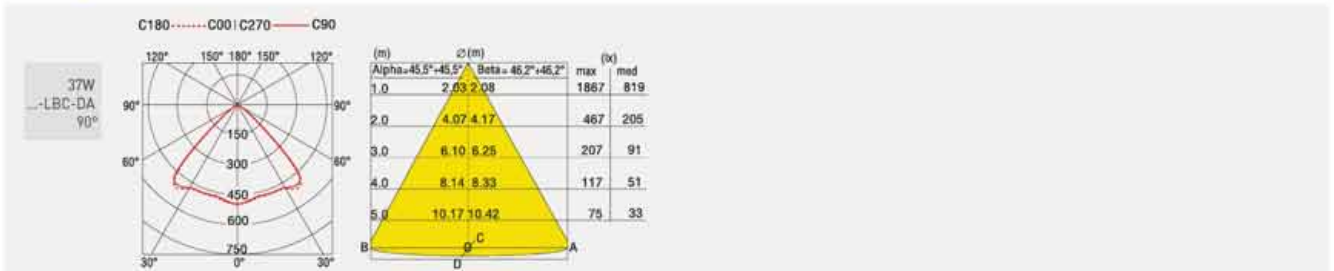

ALIMENTATORI-KIT RGB (se non in dotazione) da ordinare dalla sezione arancio - DRIVERS-RGB KITS (when not supplied) to be ordered from the section orange color





AURORA XL

- Corpo in alluminio e struttura interna in acciaio verniciati con polveri epossidiche.
- Vano ottico in pressofusione verniciato in polveri.
- Gruppo di alimentazione integrato.
- Cavo di alimentazione L 2 mt.
- Parabola in alluminio purissimo.
- Raffreddamento Led passivo.
- Schermo di protezione LED in policarbonato.
- Led durata utile: 50.000 (h).
- Consistenza cromatica: <3 mce.

- Body made of aluminum and steel, powder coated.
- Optic tray made of die-cast aluminum powder coated.
- Built-in control gear.
- Power cable L 2 mt.
- Reflector in pure aluminum.
- Passive heatsink.
- Protection LED polycarbonate frame.
- Led life: 50.000 (h).
- Chromatic consistency: <3 MCE.



	  	LED					SISTEMA-SYSTEM		
		W	lm	V	K	CRI	W	lm	lm/W
Br 5404-LBC Ne 5405-LBC Ga 5406-LBC		37W	4740	220-240V [1050mA]	3000	>90	41W	4220	103
Br 5404-LBN Ne 5405-LBN Ga 5406-LBN		37W	4970	220-240V [1050mA]	4000	>90	41W	4430	108
versione-version PLUS									
Br 5407-LBC Ne 5408-LBC Ga 5409-LBC		43W	5280	220-240V [1200mA]	3000	>90	47W	4532	96
Br 5407-LBN Ne 5408-LBN Ga 5409-LBN		43W	5520	220-240V [1200mA]	4000	>90	47W	4738	101
DALI DIM-DALI/PUSH									
Br 5404-LBC-DA Ne 5405-LBC-DA Ga 5406-LBC-DA		37W	4740	220-240V [1050mA]	3000	>90	41W	4220	103
Br 5404-LBN-DA Ne 5405-LBN-DA Ga 5406-LBN-DA		37W	4970	220-240V [1050mA]	4000	>90	41W	4430	107
versione-version PLUS									
Br 5407-LBC-DA Ne 5408-LBC-DA Ga 5409-LBC-DA		43W	5280	220-240V [1200mA]	3000	>90	47W	4532	96
Br 5407-LBN-DA Ne 5408-LBN-DA Ga 5409-LBN-DA		43W	5280	220-240V [1200mA]	4000	>90	47W	4738	101

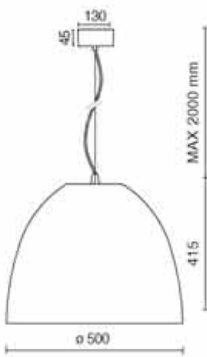

8,00

OP: A richiesta - On request: Adattatore per binario SITRACK - SITRACK adaptor
Led con temperatura di COLORE 2700K - Temperature LED COLOUR 2700K

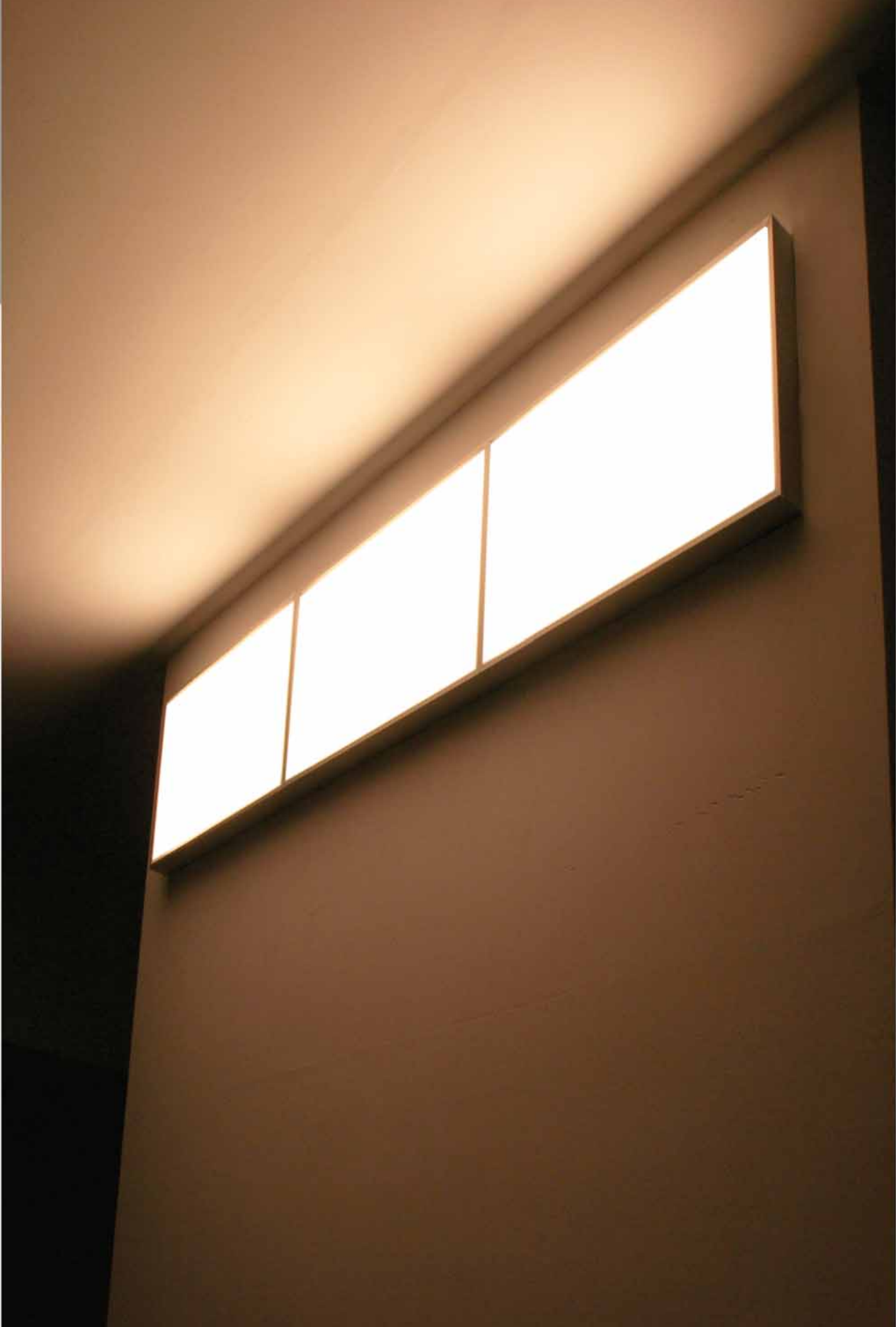

QUADRANT



- Corpo in estruso di alluminio satinato.
- Schermo diffusore a filo in policarbonato opale da 6 mm non asportabile.
- Predisposto per illuminazione solo diretta.
- Completo di kit di sospensione con 4 cavi lunghezza 2 m., con sistema di regolazione micrometrica e cavo di alimentazione.

- Body made of extruded aluminium, satin finish.
- Not removable 6 mm opal diffuser.
- Suitable only for direct lighting.
- Complete of suspension kit 4 cables length 2 m., each with micrometric adjustment system and power cable.



	LED					SISTEMA-SYSTEM		
	W	lm	V	K	CRI	W	lm	lx
PARETE E SOFFITTO - WALL AND CEILING Alts DDR40-P-LBC DDR40-P-LBN	tot. 11,8W	1150	220-240V	3000	>90	13,8W	736	53
		1200	[350mA]	4000			768	56
SOSPENSIONE - SUSPENSION Alts DDR40-LBC DDR40-LBN	tot. 11,8W	1150	220-240V	3000	>90	13,8W	736	57
		1200	[350mA]	4000			768	56

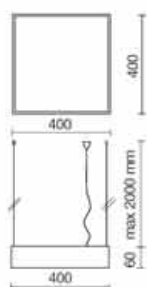

	LED					SISTEMA-SYSTEM		
	W	lm	V	K	CRI	W	lm	lx
PARETE E SOFFITTO - WALL AND CEILING Alts DDR60-LBC-P DDR60-LBI-P	tot. 47,2W	4600	220-240V	3000	>90	51,2W	2944	58
		4800	[350mA]	4000			3072	60
SOSPENSIONE - SUSPENSION Alts DDR60-LBC DDR60-LBI	tot. 47,2W	4600	220-240V	3000	>90	51,2W	2944	58
		4800	[350mA]	4000			3072	60

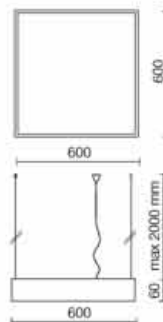

	LED					SISTEMA-SYSTEM		
	W	lm	V	K	CRI	W	lm	lx
PARETE E SOFFITTO - WALL AND CEILING Alts DDR27-P-LBC DDR27-P-LBN	25,2W	3376	220-240V	3000	>90	29,2W	1751	60
		3628	[350mA]	4000			2251	77
SOSPENSIONE - SUSPENSION Alts DDR27-LBC DDR27-LBN	25,2W	3376	220-240V	3000	>90	29,2W	1751	60
		3628	[350mA]	4000			2251	77

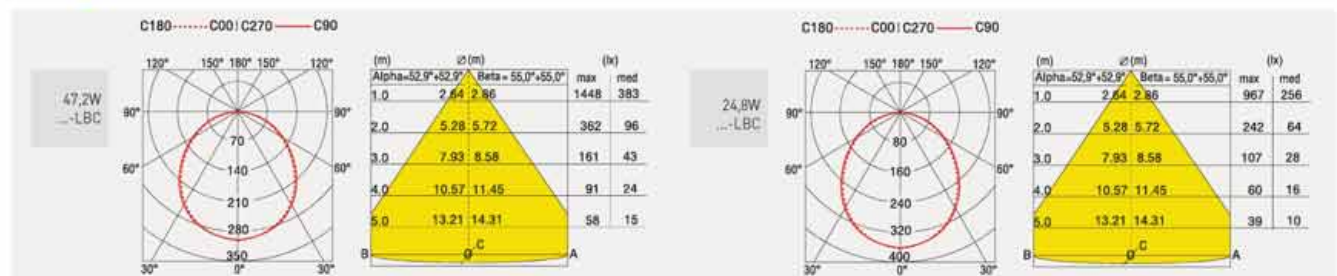
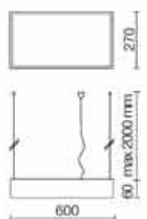

ALIMENTATORI-KIT RGB (se non in dotazione) da ordinare dalla sezione arancio - DRIVERS-RGB KITS (when not supplied) to be ordered from the section orange color



MINI TOWER MCL

- Corpo in estruso di alluminio verniciato con polveri in poliestere.
 - Riflettore in alluminio verniciato e metallizzato internamente.
 - Gruppo di alimentazione integrato.
 - Cavo di alimentazione lunghezza 2 m.
- Body made of extruded aluminium powder coated.
 - Aluminium reflector painted outside, and metalized inside.
 - Built-in control gear.
 - Power cable length 2 m.



	LED	SISTEMA-SYSTEM			
		W	lm	lm/W	
	W lm V K CRI	W	lm	lm/W	
	37W 4740 4970	220-240V (1050mA)	3000 4000	>90	41W 4228 103 41W 4433 108

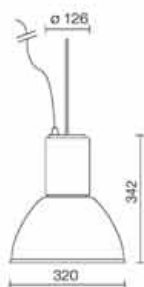

OR A richiesta - On request: con adattatore per binario SITRACK - with SITRACK adaptor
 disponibile - available altezza corpo 349 mm - height body 349 mm
 Led con temperatura di COLORE 2700K - Temperature Led COLOUR 2700K

ACC. BI 173 Rosone con fune acciaio m. 2 Base plate with 2 m. steel cable



inside

C180 C00 | C270 — C90

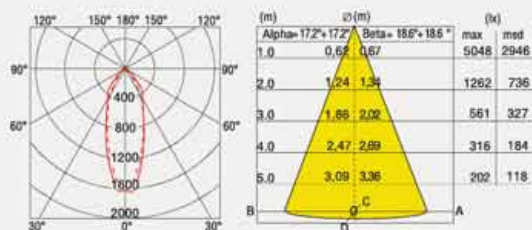

ALIMENTATORI-KIT RGB (se non in dotazione) da ordinare dalla sezione arancio - DRIVERS-RGB KITS (when not supplied) to be ordered from the section orange color

MINI TOWER MCL



- Corpo in estruso di alluminio verniciato con polveri in poliester.
- Diffusore in policarbonato.
- Gruppo di alimentazione integrato.
- Cavo di alimentazione lunghezza 2 m.
- Body made of extruded aluminium powder coated.
- Polycarbonate diffuser.
- Built-in control gear.
- Power cable length 2 m.

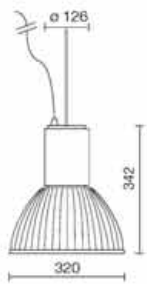

Kg	Br	LED					SISTEMA-SYSTEM		
		W	lm	V	K	CR	W	lm	IP
2,70	5413-LBC	37W	4740	220-240V	3000	>90	41W	4266	104
	5413-LBN		4970	[1050mA]	4000			4473	109

OP. A richiesta - On request: con adattatore per binario SITRACK - with SITRACK adaptor
 disponibile - available  altezza corpo 349 mm - height body 349 mm
 Led con temperatura di COLORE 2700K - Temperature LED COLOUR 2700K

Diffusore in policarbonato opale - Opal polycarbonate diffuser ---PG
 Diffusore in policarbonato con settore metallizzato - Partial metallized polycarbonate diffuser ---PA

ACC. Bi 173 Rosone con fune acciaio 2 m.
 Base plate with 2 m. steel cable

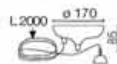

178 Kit schermo di chiusura in policarbonato completo di molle di bloccaggio
 Kit polycarbonate closing screen complete with lock springs

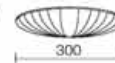

C180 C00 | C270 — C90

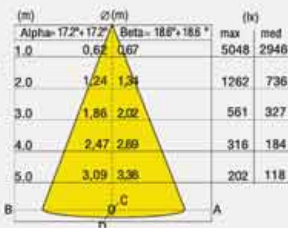
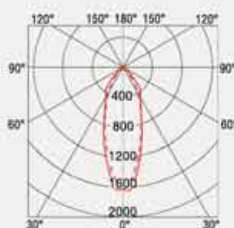

ALIMENTATORI-KIT RGB (se non in dotazione) da ordinare dalla sezione arancio - DRIVERS-RGB KITS (when not supplied) to be ordered from the section orange color



NET RANGE 15 MCL

- Corpo esterno in lamiera di alluminio, verniciato in polveri epossipoliestere.
- Gruppo di alimentazione incorporato.
- Riflettore in alluminio purissimo.
- Dissipatore lamellare passivo in alluminio estruso.

- External body of powder coated aluminium sheet.
- Built-in power supply unit.
- Pure aluminium reflector.
- Extruded aluminium heatsink.



	Br	Ga	LED					SISTEMA-SYSTEM		
			W	lm	V	K	CRI	W	lm	lp
	Br 63065-LBC	Ga 63066-LBC	17W	2500	220-240V (500mA)	3000	>90	20W	2062	103
	Br 63065-LBN	Ga 63066-LBN	17W	2665	220-240V (500mA)	4000	>90	20W	2198	110
	Br 63067-LBC	Ga 63068-LBC	24W	3365	220-240V (700mA)	3000	>90	27W	2775	103
	Br 63067-LBN	Ga 63068-LBN	24W	3570	220-240V (700mA)	4000	>90	27W	2944	109
	Br 63069-LBC	Ga 63070-LBC	57W	4740	220-240V (1050mA)	3000	>90	41W	3910	95
	Br 63069-LBN	Ga 63070-LBN	57W	4970	220-240V (1050mA)	4000	>90	41W	4099	100

OP: A richiesta - On request: Led con temperatura di COLORE 2700K - Temperature LED COLOUR 2700K
 disponibile - available



inside

C180 C00 | C270 — C90

37W
 ---LBC
 90°

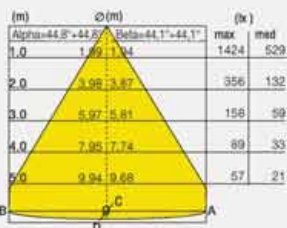
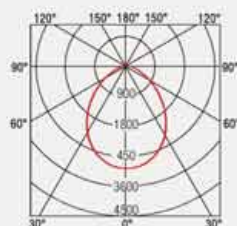

ALIMENTATORI-KIT RGB (se non in dotazione) da ordinare dalla sezione arancio - DRIVERS-RGB KITS (when not supplied) to be ordered from the section orange color

NET RANGE S 15 MCL



- Corpo esterno in lamiera di alluminio, verniciato in polveri epossipoliestere.
- Gruppo di alimentazione incorporato.
- Riflettore in alluminio purissimo.
- Dissipatore lamellare passivo in alluminio estruso.

- External body of powder coated aluminium sheet.
- Built-in power supply unit.
- Pure aluminium reflector.
- Extruded aluminium heatsink.



	Br	Ga	LED					SISTEMA-SYSTEM		
			W	lm	V	K	CRI	W	lm	lm/W
	63065-LBC-S	63066-LBC-S	17W	2500	220-240V (500mA)	3000	>90	20W	2062	103
	63065-LBN-S	63066-LBN-S	17W	2665	220-240V (500mA)	4000	>90	20W	2198	110
	63067-LBC-S	63068-LBC-S	24W	3365	220-240V (700mA)	3000	>90	27W	2775	103
	63067-LBN-S	63068-LBN-S	24W	3570	220-240V (700mA)	4000	>90	27W	2944	109
	63069-LBC-S	63070-LBC-S	37W	4740	220-240V (1050mA)	3000	>90	41W	3910	95
	63069-LBN-S	63070-LBN-S	37W	4970	220-240V (1050mA)	4000	>90	41W	4099	100

DP: A richiesta - On request: Led con temperatura di COLORE 2700K - Temperature LED COLOUR 2700K disponibile - available



<p>ACC. TIGES L 600mm Bi 999051</p>	<p>TIGES L 1200mm Bi 999061</p>	<p>KIT FUNI ACCIAIO - STEEL CABLES KIT Bi 62000-10</p>
<p>Esempio di ordinazione Ordering example</p> <p>63065-LBC-S • 999051</p>		

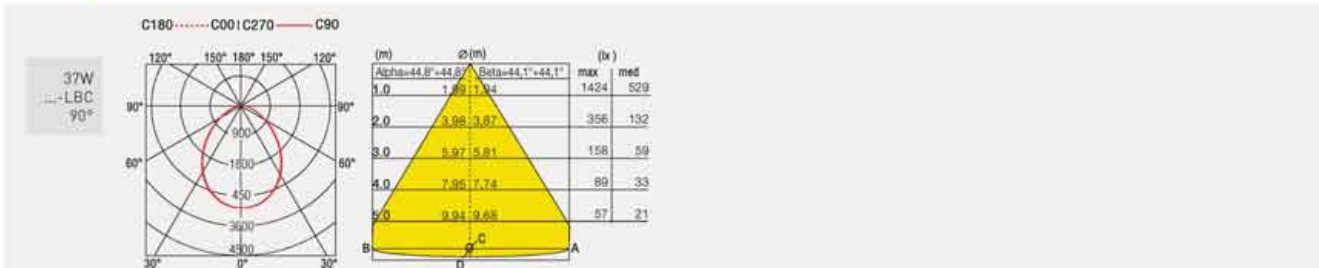

ALIMENTATORI-KIT RGB (se non in dotazione) da ordinare dalla sezione arancio - DRIVERS-RGB KITS (when not supplied) to be ordered from the section orange color



NET RANGE 18 MCL

- Corpo esterno in lamiera di alluminio, verniciato in polveri epossipoliestere.
- Gruppo di alimentazione incorporato.
- Riflettore in alluminio purissimo.
- Dissipatore lamellare passivo in alluminio estruso.

- External body of powder coated aluminium sheet.
- Built-in power supply unit.
- Pure aluminium reflector.
- Extruded aluminium heatsink.



	LED	SISTEMA-SYSTEM		
		W	lm	W
Br 63075-LBC Ga 63076-LBC	37W 4740 220-240V (1050mA)	41W	3844	94
Br 63075-LBN Ga 63076-LBN	37W 4970 220-240V (1050mA)	41W	4031	98
versione-version PLUS				
Br 63077-LBC Ga 63078-LBC	43W 5280 220-240V (1200mA)	47	4282	91
Br 63077-LBN Ga 63078-LBN	43W 5520 220-240V (1200mA)	47	4477	95

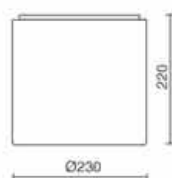

5kg
250

OP: A richiesta - On request: Led con temperatura di COLORE 2700K - Temperature LED COLOUR 2700K
disponibile - available

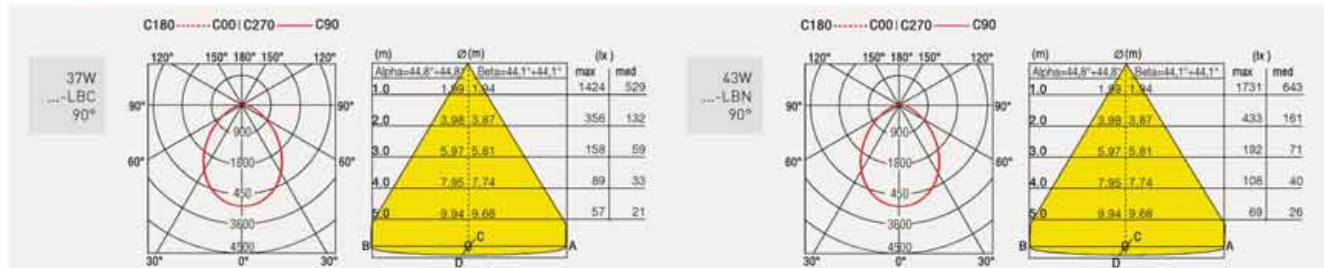

ALIMENTATORI-KIT RGB (se non in dotazione) da ordinare dalla sezione arancio - DRIVERS-RGB KITS (when not supplied) to be ordered from the section orange color



NET RANGE S 18 MCL

- Corpo esterno in lamiera di alluminio, verniciato in polveri epossipoliestere.
- Gruppo di alimentazione incorporato.
- Riflettore in alluminio purissimo.
- Dissipatore lamellare passivo in alluminio estruso.

- External body of powder coated aluminium sheet.
- Built-in power supply unit.
- Pure aluminium reflector.
- Extruded aluminium heatsink.

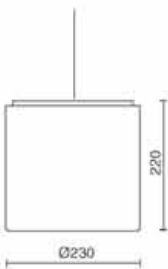

Kg
2.50

	LED	SISTEMA-SYSTEM						
		W	lm	V	K	CRI	W	lm
Br 63075-LBC-S Ga 63076-LBC-S	37W 4740	220-240V (1050mA)	3000	>90	47W	3844	94	
Br 63075-LBN-S Ga 63076-LBN-S	37W 4970	220-240V (1050mA)	4000	>90	47W	4031	98	
Versione-version PLUS								
Br 63077-LBC-S Ga 63078-LBC-S	43W 5280	220-240V (1200mA)	3000	>90	47	4282	91	
Br 63077-LBN-S Ga 63078-LBN-S	43W 5520	220-240V (1200mA)	4000	>90	47	4477	95	

DP: A richiesta - On request: Led con temperatura di COLORE 2700K - Temperature LED COLOUR 2700K disponibile - available



ACC. TIGES L. 600mm
Bi 999051

TIGES L. 1200mm
Bi 999061

KIT FUNI ACCIAIO - STEEL CABLES KIT
Bi 62000-10

Esempio di ordinazione
Ordering example: 63075-LBC-S • 999051

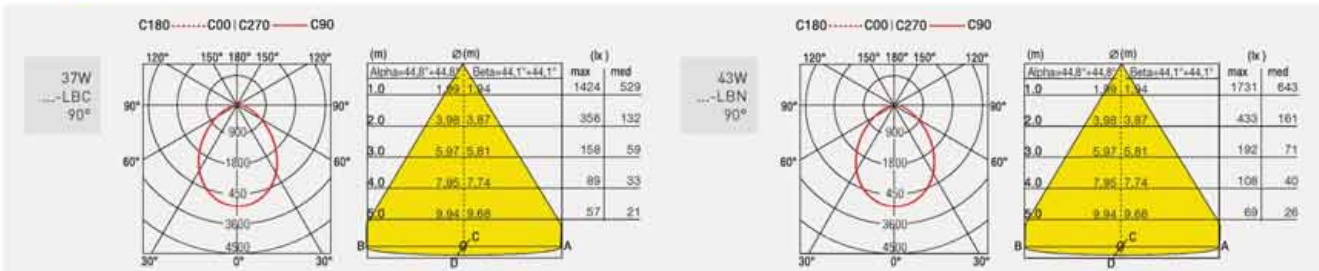

ALIMENTATORI-KIT RGB (se non in dotazione) da ordinare dalla sezione arancio - DRIVERS-RGB KITS (when not supplied) to be ordered from the section orange color



FASCIO STANDARD - STANDARD BEAM

UGR <19

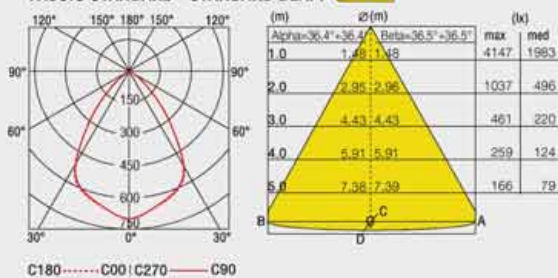

FASCIO DIFFUSO - DIFFUSED OPTIC

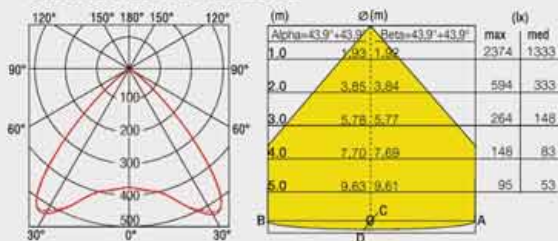

FASCIO DOPPIO ASIMMETRICO - DOUBLE ASYMMETRIC BEAM

UGR <19

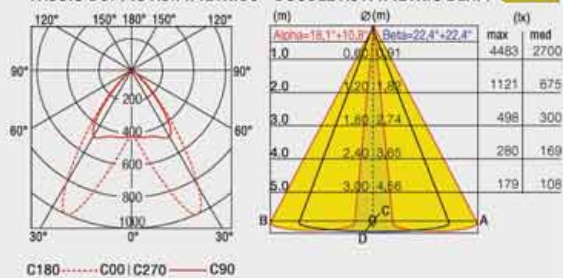

FASCIO ASIMMETRICO - ASYMMETRIC BEAM

UGR <19

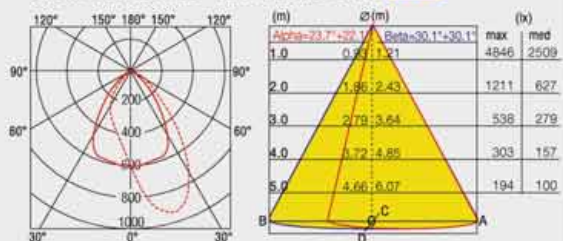

ROSS PARETE



- Corpo in materiale termoplastico.
 - Lente in PMMA.
 - Dissipatore passivo.
 - Temperatura esercizio -20° +35°.
 - Pressacavo in nylon 66.
 - Apparecchio conforme alle norme EN60598-1.
 - Led durata utile: 50.000 (h) L80 B10.
 - Consistenza cromatica: 3 SDCM.
- Body in thermoplastic material.
 - PMMA lens.
 - Passive heatsink.
 - Operating temperature -20 ° + 35 °.
 - Nylon 66 cable gland.
 - Fitting compliant to EN60598-1 standards.
 - Led life: 50.000 (h) L80 B20.
 - Chromatic consistency: 3 SDCM.

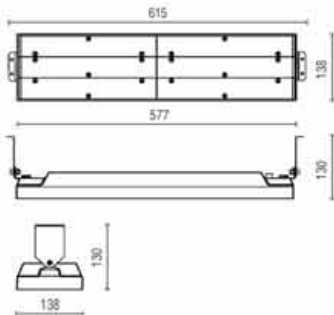

					LED					SISTEMA-SYSTEM		
					W	lm	V	K	CRI	W	lm	lm
ON-OFF												
Br	4465-LBC	4467-LBC	4469-LBC	4471-LBC	43,5W	7020	220-240V [500mA]	3000	>80	47,5W	6894	145
Ne	4466-LBC	4468-LBC	4470-LBC	4472-LBC								
Br	4465-LBN	4467-LBN	4469-LBN	4471-LBN	43,5W	7365	220-240V [500mA]	4000	>80	47,5W	7233	152
Ne	4466-LBN	4468-LBN	4470-LBN	4472-LBN								
DALI DIM-DALI/PUSH												
Br	4465-LBC-DA	4467-LBC-DA	4469-LBC-DA	4471-LBC-DA	43,5W	7020	220-240V [500mA]	3000	>80	47,5W	6894	145
Ne	4466-LBC-DA	4468-LBC-DA	4470-LBC-DA	4472-LBC-DA								
Br	4465-LBN-DA	4467-LBN-DA	4469-LBN-DA	4471-LBN-DA	43,5W	7065	220-240V [500mA]	4000	>80	47,5W	7233	152
Ne	4466-LBN-DA	4468-LBN-DA	4470-LBN-DA	4472-LBN-DA								
EM EMERGENZA-EMERGENCY - 1H												
Br	4465-LBC-EM	4467-LBC-EM	4469-LBC-EM	4471-LBC-EM	43,5W	7020	220-240V [500mA]	3000	>80	47,5W	6894	145
Ne	4466-LBC-EM	4468-LBC-EM	4470-LBC-EM	4472-LBC-EM								
Br	4465-LBN-EM	4467-LBN-EM	4469-LBN-EM	4471-LBN-EM	43,5W	7365	220-240V [500mA]	4000	>80	47,5W	7233	152
Ne	4466-LBN-EM	4468-LBN-EM	4470-LBN-EM	4472-LBN-EM								

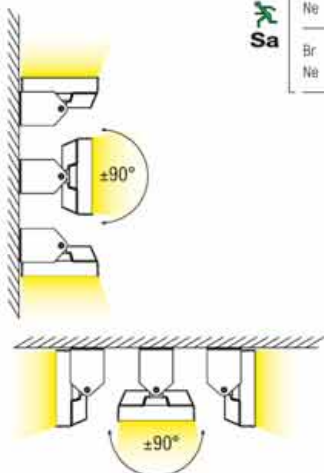

IP 40

ALIMENTATORI-KIT RGB (se non in dotazione) da ordinare dalla sezione arancio - DRIVERS-RGB KITS (when not supplied) to be ordered from the section orange color





FASCIO STANDARD - STANDARD BEAM

UGR <19

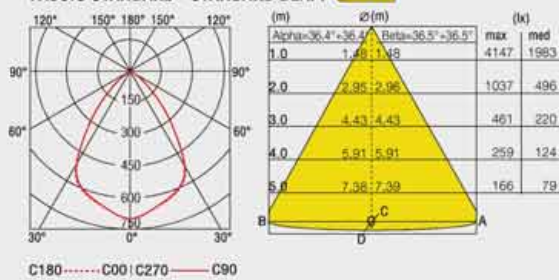

C180 - - - - C00 | C270 - - - - C90

FASCIO DOPPIO ASIMMETRICO - DOUBLE ASYMMETRIC BEAM

UGR <19

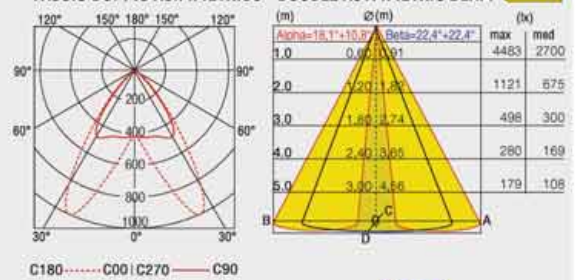

C180 - - - - C00 | C270 - - - - C90

FASCIO DIFFUSO - DIFFUSED OPTIC

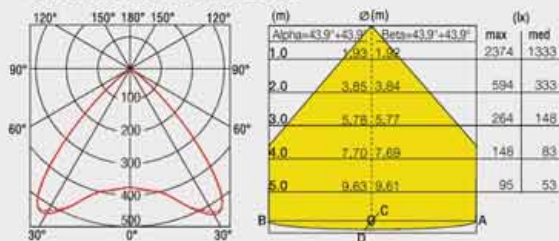

FASCIO ASIMMETRICO - ASYMMETRIC BEAM

UGR <19

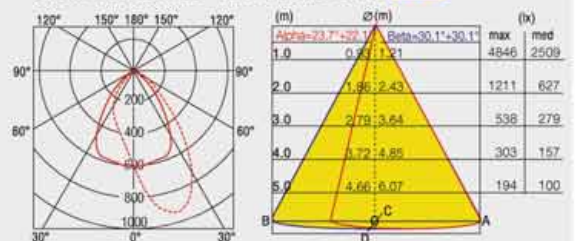

ROSS SOSPENSIONE



- Corpo in materiale termoplastico.
 - Lente in PMMA.
 - Dissipatore passivo.
 - Temperatura esercizio -20° +35°.
 - Pressacavo in nylon 66.
 - Apparecchio conforme alle norme EN60598-1.
 - Led durata utile: 50.000 (h) L80 B10.
 - Consistenza cromatica: 3 SDCM.
- Body in thermoplastic material.
 - PMMA lens.
 - Passive heatsink.
 - Operating temperature -20 ° + 35 °.
 - Nylon 66 cable gland.
 - Fitting compliant to EN60598-1 standards.
 - Led life: 50.000 (h) L80 B20.
 - Chromatic consistency: 3 SDCM.

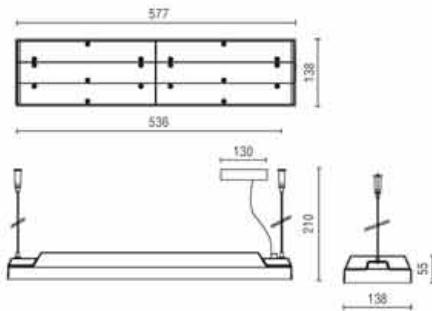

					LED					SISTEMA-SYSTEM		
					W	lm	V	K	CRi	W	lm	lm
ON-OFF												
Br	4475-LBC	4477-LBC	4479-LBC	4481-LBC	43,5W	7020	220-240V [500mA]	3000	>80	47,5W	6894	145
Ne	4476-LBC	4478-LBC	4480-LBC	4482-LBC								
Br	4475-LBN	4477-LBN	4479-LBN	4481-LBN	43,5W	7365	220-240V [500mA]	4000	>80	47,5W	7233	152
Ne	4476-LBN	4478-LBN	4480-LBN	4482-LBN								
DALI DIM-DALI/PUSH												
Br	4475-LBC-DA	4477-LBC-DA	4479-LBC-DA	4481-LBC-DA	43,5W	7020	220-240V [500mA]	3000	>80	47,5W	6894	145
Ne	4476-LBC-DA	4478-LBC-DA	4480-LBC-DA	4482-LBC-DA								
Br	4475-LBN-DA	4477-LBN-DA	4479-LBN-DA	4481-LBN-DA	43,5W	7365	220-240V [500mA]	4000	>80	47,5W	7233	152
Ne	4476-LBN-DA	4478-LBN-DA	4480-LBN-DA	4482-LBN-DA								
EM EMERGENZA-EMERGENCY - 1H												
Br	4475-LBC-EM	4477-LBC-EM	4479-LBC-EM	4481-LBC-EM	43,5W	7020	220-240V [500mA]	3000	>80	47,5W	6894	145
Ne	4476-LBC-EM	4478-LBC-EM	4480-LBC-EM	4482-LBC-EM								
Br	4475-LBN-EM	4477-LBN-EM	4479-LBN-EM	4481-LBN-EM	43,5W	7365	220-240V [500mA]	4000	>80	47,5W	7233	152
Ne	4476-LBN-EM	4478-LBN-EM	4480-LBN-EM	4482-LBN-EM								

- Rosone verniciato e cavi in acciaio con regolazione micro metrica.
- Cavo alimentazione 3/5 x 0,75mm².
- Painted canopy and steel cables with micro metric adjustment.
- Power cable: 3/5 x 0.75mm².



ALIMENTATORI-KIT RGB (se non in dotazione) da ordinare dalla sezione arancio - DRIVERS-RGB KITS (when not supplied) to be ordered from the section orange color



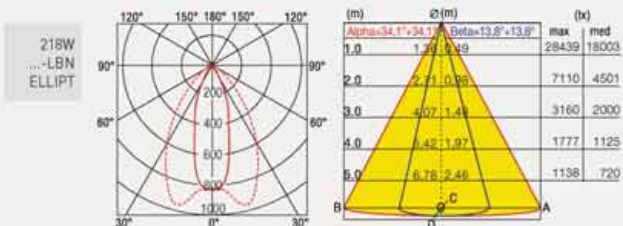
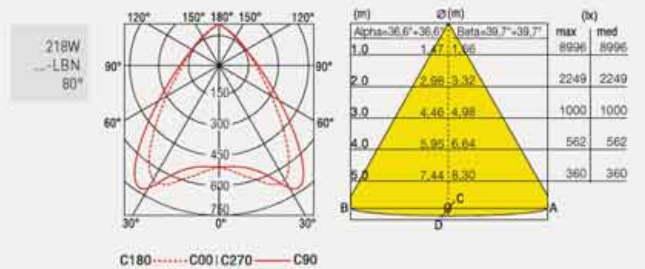
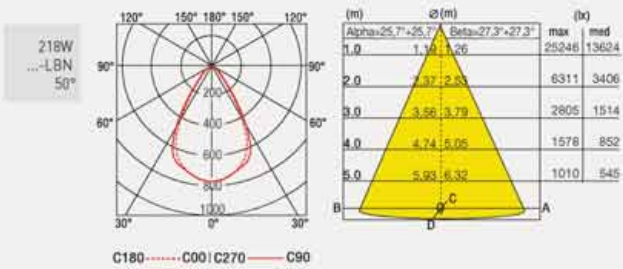
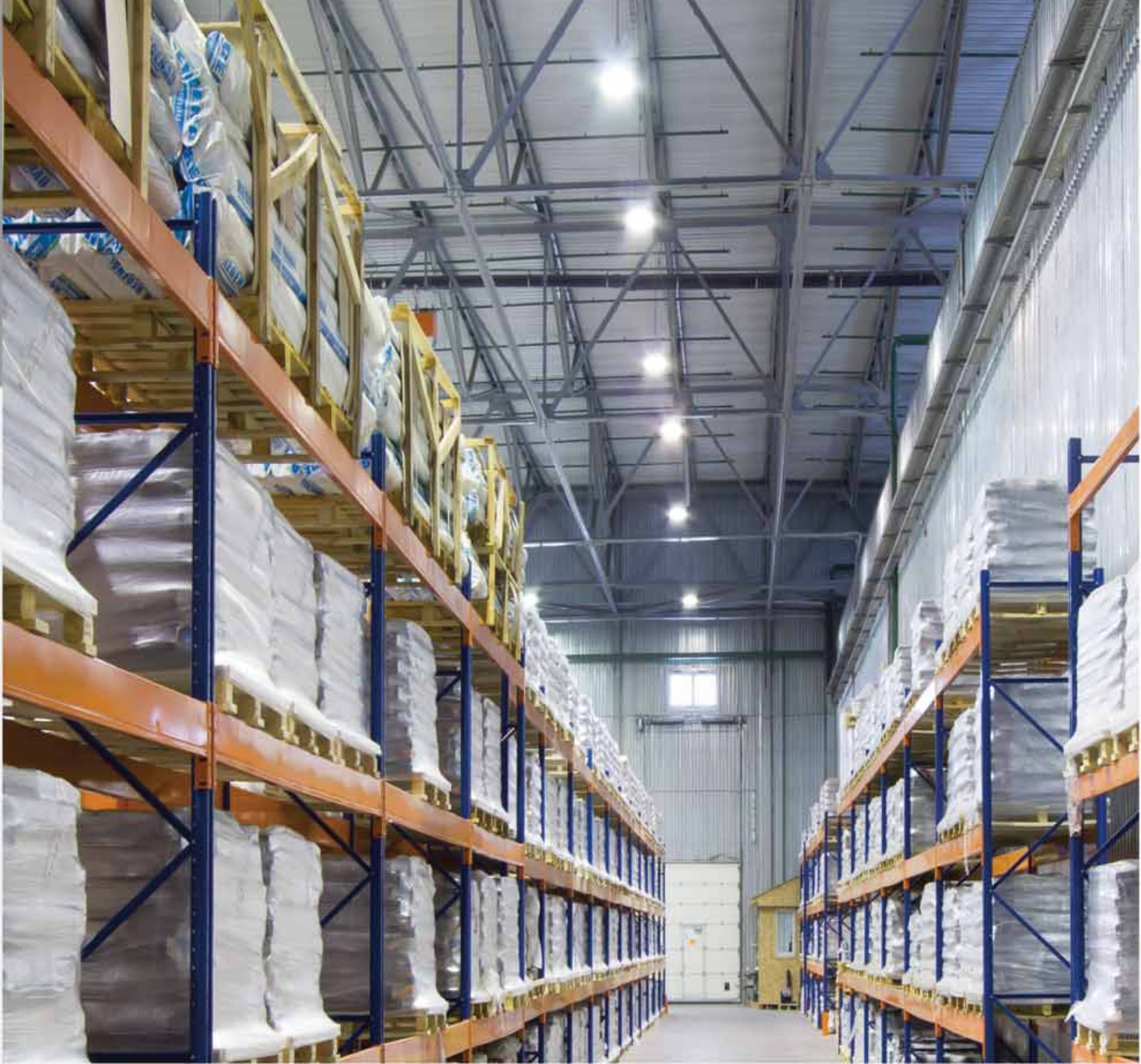

ALIMENTATORI-KIT RGB (se non in dotazione) da ordinare dalla sezione arancio - DRIVERS-RGB KITS (when not supplied) to be ordered from the section orange color

SD-HIGHBAY



- Corpo in alluminio pressofuso con alette dissipanti integrate.
- Verniciatura con polveri di poliestere con trattamento speciale per esterni.
- Riflettore in alluminio purissimo.
- Vetro di protezione spessore 4 mm temperato extrachiario.
- Connettore stagno IP68 presa/spina ad innesto rapido.
- Dispositivo di protezione sovratensioni 10 KV.
- Ta -25+40°C.
- Led durata utile: 85.000 (h) L80 B10.
- Consistenza cromatica: 2 SDCM.
- Fattore di potenza > 0,95.
- Lumen tipici aTp. 65°, Temperatura rilevata Tp 62°C.
- Utilizzabile con linee di emergenza ad alimentazione centralizzata.

- Die-cast aluminum body with integrated dissipating fins.
- Painting with polyester powders with special treatment for outdoor use.
- Reflector in pure aluminum.
- Clear tempered glass diffuser 4mm thick.
- IP68 quick plug and socket.
- 10 KV surge protection device (SPD).
- Working temperature: -25 +40°C.
- Led life: 85.000 (h) L80 B10.
- Chromatic consistency: 2 SDCM.
- Power factor > 0.95.
- Lumen typical values aTp. 65°, Temperature detected Tp 62°C.
- Usable with emergency lines with centralized power-supply.

	50	80	E	LED		SISTEMA-SYSTEM						
				W	lm	V	K	CRI	W	lm	W	
SOSPENSIONE - SUSPENSION												
 440	GrA	E6000-LBN	E6005-LBN	E6010-LBN	218W	32640	220-240V [1050mA]	4000	>90	234W*	28530*	122
	GrA	E6001-LBN	E6006-LBN	E6011-LBN	148W	21720	220-240V [1050mA]	4000	>90	164W*	18219*	111
	GrA	E6003-LBN	E6007-LBN	E6009-LBN	82W	13560	220-240V [600mA]	4000	>90	92W*	11374*	124
DALI DIM-DALI/PUSH												
 130	GrA	E6000-LBN-DA	E6005-LBN-DA	E6010-LBN-DA	218W	32640	220-240V [1050mA]	4000	>90	234W*	28530*	122
	GrA	E6001-LBN-DA	E6006-LBN-DA	E6011-LBN-DA	148W	21720	220-240V [1050mA]	4000	>90	164W*	18219*	111
	GrA	E6003-LBN-DA	E6007-LBN-DA	E6009-LBN-DA	82W	13560	220-240V [600mA]	4000	>90	92W*	11374*	124
PARETE/PLAFONE - WALL/CEILING												
 440 195	GrA	E6000-LBN-P	E6005-LBN-P	E6010-LBN-P	218W	32640	220-240V [1050mA]	4000	>90	234W*	28530*	122
	GrA	E6001-LBN-P	E6006-LBN-P	E6011-LBN-P	148W	21720	220-240V [1050mA]	4000	>90	164W*	18219*	111
	GrA	E6003-LBN-P	E6007-LBN-P	E6009-LBN-P	82W	13560	220-240V [600mA]	4000	>90	92W*	11374*	124
DALI DIM-DALI/PUSH												
 440 195	GrA	E6000LBN-DA-P	E6005LBN-DA-P	E6010LBN-DA-P	218W	32640	220-240V [1050mA]	4000	>90	234W*	28530*	122
	GrA	E6001LBN-DA-P	E6006LBN-DA-P	E6011LBN-DA-P	148W	21720	220-240V [1050mA]	4000	>90	164W*	18219*	111
	GrA	E6003LBN-DA-P	E6007LBN-DA-P	E6009LBN-DA-P	82W	13560	220-240V [600mA]	4000	>90	92W*	11374*	124

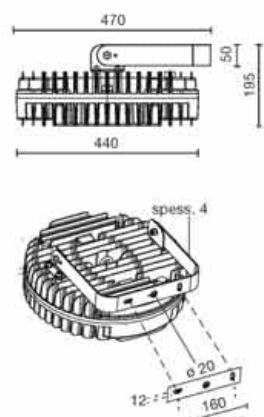

OP. A richiesta - On request: griglia di protezione - protection grid

ACC. E6002 Paraluce - Lens hood

*Valori riferiti agli apparecchi con fascio luminoso da 80° - Value for fittings with beam angle 80°

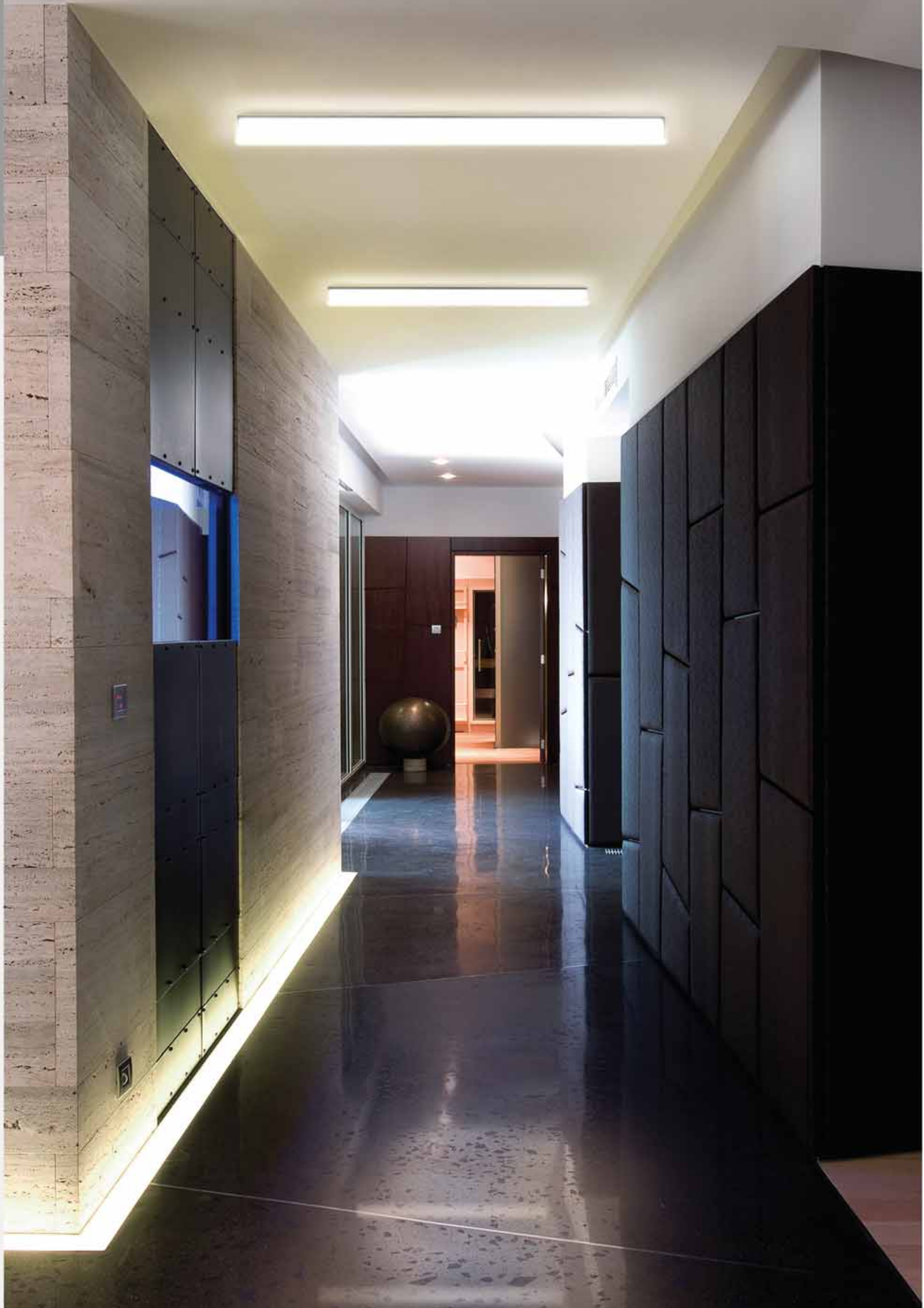

ELISEO PARETE



- Struttura in estruso d'alluminio verniciato bianco.
- Testate in materiale termoplastico.
- Diffusore in policarbonato opalino.
- Alimentatore elettronico incorporato.
- Schermo in alluminio satinato.
- Led durata utile: 50.000 [h] L80 B10.
- Consistenza cromatica: 3 SDCM.

- Body made of white painted extruded aluminium.
- End caps of thermoplastic materials.
- Diffuser made of opaline polycarbonate.
- Built-in electronic power unit.
- Satin aluminium reflector.
- Led life: 50.000 [h] L80 B10.
- Chromatic consistency: 3 SDCM.



	L [mm]	LED					SISTEMA-SYSTEM			
		W	lm	V	K	CRI	W	lm	W	
	3424-830	602	14,5W	2340	220-240V [500mA]	3000	>90	16,5W	1280	78
	3425-830	902	21,7W	3510				24,7W	1925	78
	3426-830	1202	29W	4680				33W	2560	78
	3427-830	1502	36,2W	5850				40,2W	3210	80
	3424-840	602	14,5W	2455	220-240V [500mA]	4000	>90	16,5W	1345	82
	3425-840	902	21,7W	3685				24,7W	2020	82
	3426-840	1202	29W	4910				33W	2660	82
	3427-840	1502	36,2W	6140				40,2W	3370	84
DALI DIM-DALI/PUSH										
	3424-830-DA	602	14,5W	2340	220-240V [500mA]	3000	>90	16,5W	1280	78
	3425-830-DA	902	21,7W	3510				24,7W	1925	78
	3426-830-DA	1202	29W	4680				33W	2560	78
	3427-830-DA	1502	36,2W	5850				40,2W	3210	80
	3424-840-DA	602	14,5W	2455	220-240V [500mA]	4000	>90	16,5W	1345	82
	3425-840-DA	902	21,7W	3685				24,7W	2020	82
	3426-840-DA	1202	29W	4910				33W	2690	82
	3427-840-DA	1502	36,2W	6140				40,2W	3370	84
SCHERMO CON FRONTE IN ALLUMINIO ANODIZZATO E SATINATO REFLECTOR WITH FRONT IN ANODIZED AND SATINATED ALUMINUM										
	3429-830	602	14,5W	2340	220-240V [500mA]	3000	>90	16,5W	890	54
	3430-830	902	21,7W	3510				24,7W	1340	54
	3431-830	1202	29W	4680				33W	1780	54
	3432-830	1502	36,2W	5850				40,2W	2230	55
	3429-840	602	14,5W	2455	220-240V [500mA]	4000	>90	16,5W	935	57
	3430-840	902	21,7W	3685				24,7W	1405	57
	3431-840	1202	29W	4910				33W	1870	57
	3432-840	1502	36,2W	6140				40,2W	2340	58
DALI DIM-DALI/PUSH										
	3429-830-DA	602	14,5W	2340	220-240V [500mA]	3000	>90	16,5W	890	54
	3430-830-DA	902	21,7W	3510				24,7W	1340	54
	3431-830-DA	1202	29W	4680				33W	1780	54
	3432-830-DA	1502	36,2W	5850				40,2W	2230	55
	3429-840-DA	602	14,5W	2455	220-240V [500mA]	4000	>90	16,5W	935	57
	3430-840-DA	902	21,7W	3685				24,7W	1405	57
	3431-840-DA	1202	29W	4910				33W	1870	57
	3432-840-DA	1502	36,2W	6140				40,2W	2340	58





ELISEO SOSPENSIONE

- Struttura in estruso d'alluminio verniciato bianco.
- Testate in materiale termoplastico.
- Diffusore in policarbonato opalino.
- Alimentatore elettronico incorporato.
- Schermo in alluminio satinato.
- Led durata utile: 50.000 (h) L80 B10.
- Consistenza cromatica: 3 SDCM.

- Body made of white painted extruded aluminium.
- En caps of thermoplastic materials.
- Diffuser made of opaline polycarbonate.
- Built-in electronic power unit.
- Satin aluminium reflector.
- Led life: 50.000 (h) L80 B10.
- Chromatic consistency: 3 SDCM.

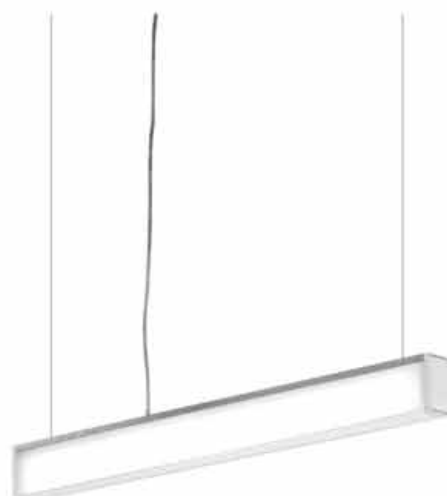

	L (mm)	LED				SISTEMA-SYSTEM			
		W	lm	V	K	CRI	W	lm	lm/W
SINGOLA - SINGLE									
3409-830	602	14,5W	2340				16,5W	1280	78
Br 3410-830	902	21,7W	3510	220-240V	3000	>90	24,7W	1925	78
3411-830	1202	29W	4680	[500mA]			33W	2560	78
3412-830	1502	36,2W	5850				40,2W	3210	80
3409-840	602	14,5W	2455				16,5W	1345	82
Br 3410-840	902	21,7W	3685	220-240V	4000	>90	23,7W	2020	82
3411-840	1202	29W	4910	[500mA]			31W	2690	82
3412-840	1502	36,2W	6140				40,2W	3370	84
DALI DIM-DALI/PUSH									
3409-830-DA	602	14,5W	2340				16,5W	1280	78
Br 3410-830-DA	902	21,7W	3510	220-240V	3000	>90	24,7W	1925	78
3411-830-DA	1202	29W	4680	[500mA]			33W	2560	78
3412-830-DA	1502	36,2W	5850				40,2W	3210	80
3409-840-DA	602	14,5W	2455				16,5W	1345	82
Br 3410-840-DA	902	21,7W	3685	220-240V	4000	>90	23,7W	2020	82
3411-840-DA	1202	29W	4910	[500mA]			31W	2690	82
3412-840-DA	1502	36,2W	6140				40,2W	3370	84
DOPPIA VERTICALE									
DOUBLE VERTICAL									
3414-830	652	29W	4680				31W	2560	83
Br 3415-830	952	43,4W	7020	220-240V	3000	>90	46,4W	3850	83
3416-830	1252	58W	9360	[500mA]			62W	5120	83
3417-830	1552	72,4W	11700				76,4W	6420	84
3414-840	602	29W	4910				31W	2690	87
Br 3415-840	902	43,4W	7370	220-240V	4000	>90	46,4W	4040	87
3416-840	1202	58W	9820	[500mA]			62W	5380	87
3417-840	1502	72,4W	12280				76,4W	6740	88
DALI DIM-DALI/PUSH									
3414-830-DA	602	14,5W	2340				16,5W	2560	83
Br 3415-830-DA	902	21,7W	3510	220-240V	3000	>90	24,7W	3850	83
3416-830-DA	1202	29W	4680	[500mA]			33W	5120	83
3417-830-DA	1502	36,2W	5850				40,2W	6420	84
3414-840-DA	602	14,5W	2455				16,5W	2690	87
Br 3415-840-DA	902	21,7W	3685	220-240V	4000	>90	23,7W	4040	87
3416-840-DA	1202	29W	4910	[500mA]			31W	5380	87
3417-840-DA	1502	36,2W	6140				40,2W	6740	88



Icona	L (mm)	LED					SISTEMA-SYSTEM				
		W	lm	V	K	CRi	W	lm	h		
	DOPPIA ORIZZONTALE										
	DOUBLE HORIZONTAL										
	Br	3419-830	602	29W	4680	220-240V [500mA]	3000	>90	31W	2560	83
		3420-830	902	43,4W	7020				46,4W	3850	83
		3421-830	1202	58W	9360				62W	5120	83
		3422-830	1502	72,4W	11700				76,4W	5120	83
	Br	3419-840	602	29W	4910	220-240V [500mA]	4000	>90	31W	2690	87
		3420-840	902	43,4W	7570				46,4W	4040	87
		3421-840	1202	58W	9820				62W	5380	87
		3422-840	1502	72,4W	12280				76,4W	6740	88
		DIM-DALI/PUSH									
		Br	3419-830-DA	602	14,5W	2340	220-240V 500mA]	3000	>90	16,5W	2560
3420-830-DA			902	21,7W	3510	24,7W				3850	83
3421-830-DA			1202	29W	4680	33W				5120	83
3422-830-DA			1502	36,2W	5850	40,2W				5120	83
Br		3419-840-DA	602	14,5W	2455	220-240V 500mA]	4000	>90	16,5W	2690	87
		3420-840-DA	902	21,7W	3685				23,7W	4040	87
		3421-840-DA	1202	29W	4910				31W	5380	87
		3422-840-DA	1502	36,2W	6140				40,2W	6740	88



ACC. ...-EU Versione a binario - Track version

IP 40

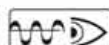

inside

ALIMENTATORI-KIT RGB (se non in dotazione) da ordinare dalla sezione arancio - DRIVERS-RGB KITS (when not supplied) to be ordered from the section orange color

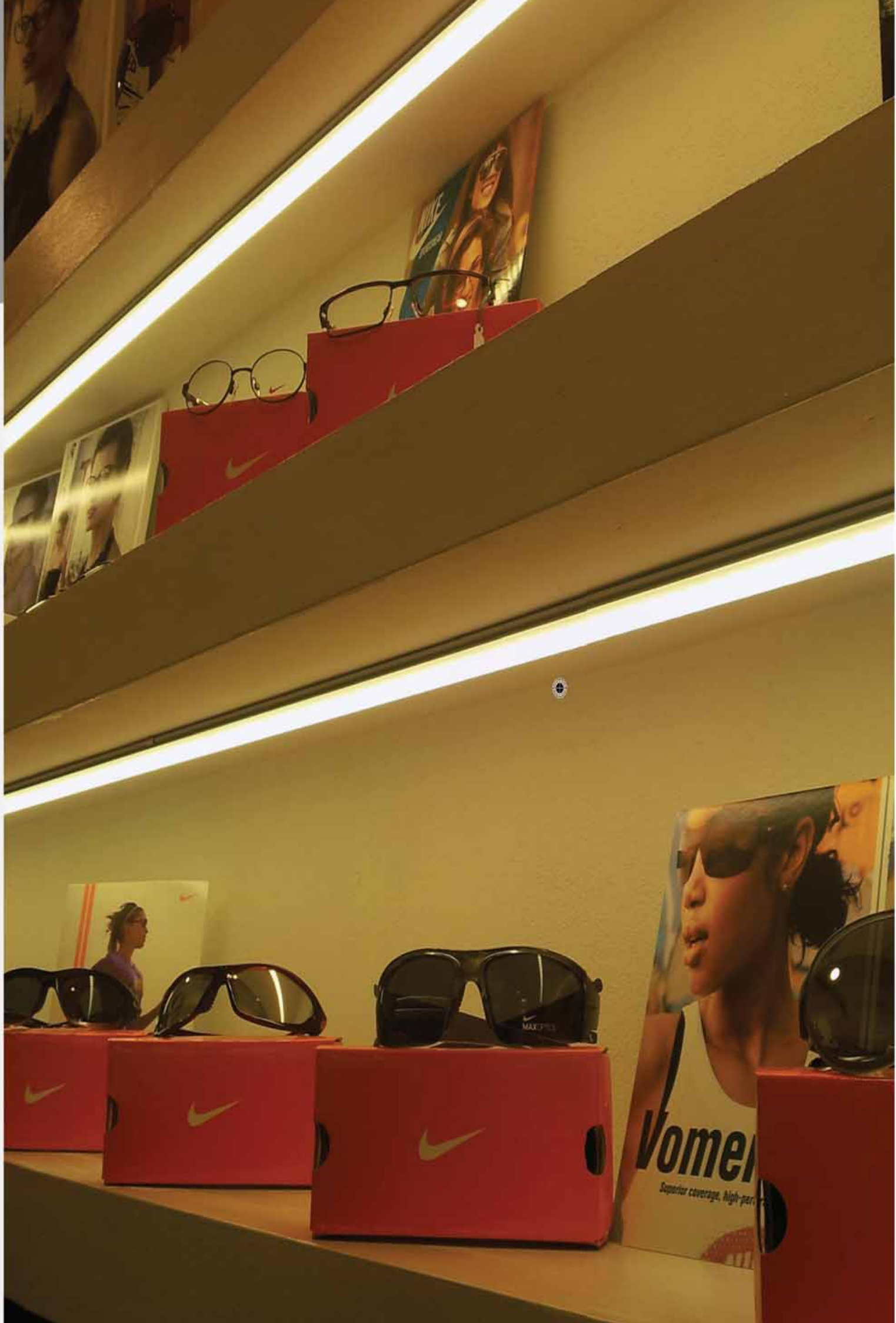

SLIM LED



- Corpo in alluminio estruso anodizzato.
- Diffusore in policarbonato opale.
- Accessorio per aggancio fisso in dotazione, a richiesta per aggancio semiorientabile.
- Led durata utile: 25.000 (h) L80 B20.

- Body made of extruded anodized aluminium.
- Opal polycarbonate diffuser.
- Accessory for wall fixing included, supports adjustable mode on request.
- Led life: 25.000 (h) L80 B20.

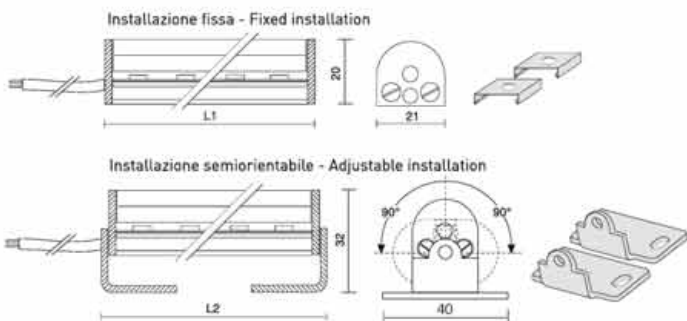

	L1 [mm]	L2 [mm]	LED				SYSTEM-SYSTEM						
			W	lm	V	K	CRI	W	lm	lm/W			
VERSIONE AD ALTA EFFICIENZA HIGH VERSION EFFECIENCY													
		Als	SL940-LBC	520	530	7,2W	540	24Vdc	3000	>90	7,2W	433	60
			SL940-LBN			585	4000		470		65		
			SL940-LBI			610	5000		490		68		
	Als	SL941-LBC	1020	1030	14,4W	1080	24Vdc	3000	>90	14,4W	866	60	
		SL941-LBN			1170	4000		938		65			
		SL941-LBI			1220	5000		978		68			
	Als	SL942-LBC	1520	1530	21,6W	1620	24Vdc	3000	>90	21,6W	1300	60	
		SL942-LBN			1755	4000		1408		65			
		SL942-LBI			1830	5000		1467		68			
	Als	SL943-LBC	2020	2030	28,8W	2160	24Vdc	3000	>90	28,8W	1732	60	
		SL943-LBN			2340	4000		1876		65			
		SL943-LBI			2440	5000		1957		68			
	Als	SL944-LBC	2520	2530	36W	2700	24Vdc	3000	>90	36W	2165	60	
		SL944-LBN			2925	4000		2346		65			
		SL944-LBI			3050	5000		2446		68			

OP: A richiesta - On request: 12 Vdc

ACC: 130 Staffa di fissaggio per installazione orientabile - Support for adjustable installation



STRIP 3	L [m]	TAGLIO [mm] CUT [mm]	W [m]	lm [m]	V	K	CRI	LARGHEZZA [mm] WIDE [mm]	N. LED	ALIMENTATORE - DRIVER
645777-LBC	5	25	19W	1440	24Vdc	3200	>90	10	240	645038 [60W 230-24V for max 3m.] 645178 [100W 230-24V for max 5m.]
645777-LBN				1500						
645777-LBI				1560						

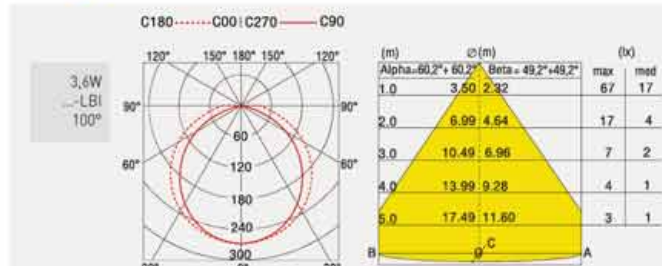
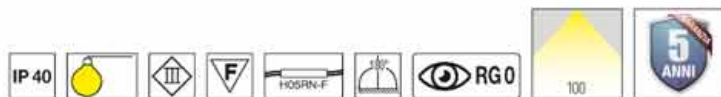

ALIMENTATORI-KIT RGB (se non in dotazione) da ordinare dalla sezione arancio - DRIVERS-RGB KITS (when not supplied) to be ordered from the section orange color



TAPE



TAPE la nuova gamma di prodotti realizzati per sostituire gli ormai obsoleti tubi al neon, laddove questi vengono normalmente impiegati per l'illuminazione interna di vetrine e banchi frigo.

Una delle caratteristiche principali, una volta installato il prodotto, è la possibilità di sostituire la stripled con estrema semplicità. **TAPE** è stato progettato con un sistema di profili a scatto, che consentono la rimozione di alcune parti senza dover smontare l'intero apparecchio.

TAPE is a new range of products studied to replace obsolete neon tubes, when these are used to illuminate display cabinets and fridge counters.

One of the main features, once the product is installed, it is the possibility to replace the stripled with extreme simplicity.

TAPE has been designed with click mounting profiles, which allows an the easy opening without tools.



Brevettato - Patent



TAPE

TAPE si caratterizza per la possibilità di avere diverse configurazioni, che si differenziano tra loro per le caratteristiche illuminotecniche, meccaniche ed elettroniche.

L'illuminazione di un banco frigorifero è un aspetto fondamentale per un'ottima performance di vendita.

La durata dei LED supera le 50.000 ore, valori ben superiori alla durata media di un tubo fluorescente.

Ciò garantisce un ulteriore risparmio sui costi di manutenzione e sull'acquisto delle lampade. La maggiore direzionalità del fascio, l'assoluta stabilità della luce, l'assenza di interferenze e il rendimento ottimale alle basse temperature si traducono in una migliore intensità luminosa sul prodotto, limitando gli sprechi e mettendo in maggiore evidenza le merci.

TAPE può essere utilizzato, oltre che per i banchi frigo, per l'illuminazione dei piani cucina installandolo sotto i pensili, espositori di negozi e banchi bar.

TAPE is characterized by the possibility of having different configurations, which differ from each other by lighting, mechanical and electronic characteristics.

The lighting of a refrigerated counter is a fundamental aspect for an excellent sales performance.

LED life exceeds 50.000 hours, values above the average life of a fluorescent tube.

This guarantees further savings on maintenance costs and on the purchase of lamps. The greater directionality of the beam, the absolute stability of light, the absence of interference and the optimal performance at low temperatures produce better light intensity on the product, limiting waste and highlighting the goods.

TAPE can also be used to light up kitchen counter tops, (installing it under the kitchen cupboards) shops displays and bar counters.

SCHEMA DI MONTAGGIO PER SOSTITUZIONE STRIPLED
MOUNTING INSTRUCTIONS FOR REPLACEMENT STRIPLED

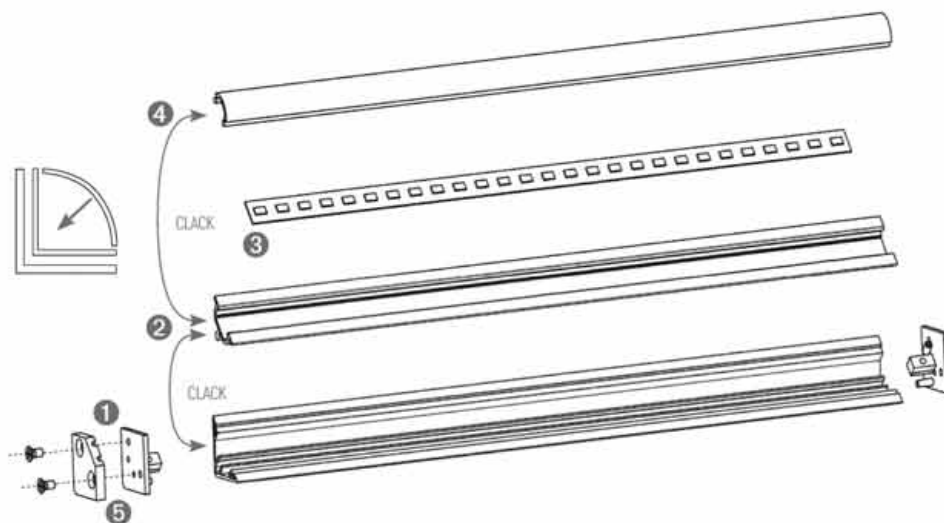

1. Fissare alla superficie il corpo estruso in materiale termoplastico con biadesivo o viti. In caso di sostituzione della strip led questo estruso non dovrà essere rimosso.
 2. Aggancio a scatto del supporto in alluminio per strip led.
 3. Incollare le strip led.
 4. Aggancio a scatto dello schermo in policarbonato opale.
 5. Fissaggio delle testate di chiusura mediante le viti in dotazione.
1. Fix the extruded body made of thermoplastic material with double-sided adhesive or screws to the surface. The body should not be removed if you replace the strip led.
 2. Snap the aluminum support into place.
 3. Glue the strip led.
 4. Snap on the opal polycarbonate screen.
 5. Fasten the end caps using the supplied screws.

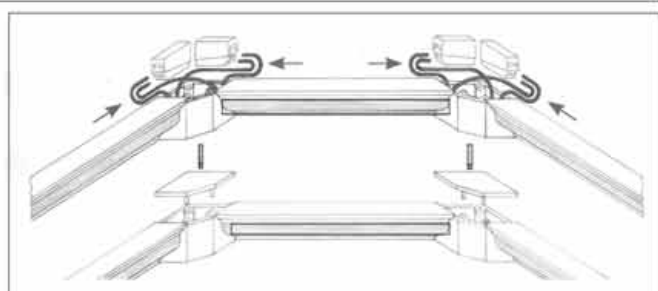
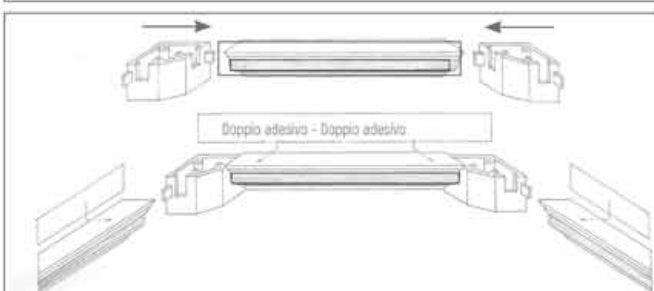

























TAPE

- Corpo estruso in materiale termoplastico.
- Schermo in policarbonato opale.
- Possibilità di sostituzione del LED dal corpo fisso.
- Extruded body in thermoplastic material.
- Polycarbonate opal screen.
- Possibility of replacing the LED from the fixed body.



			L (mm)	W	lm	V	K	CRI
		Br	6030-827 6030-830 6030-840	140	15W 107 116	24V	2700 3000 4000	>90
		Br	6031-827 6031-830 6031-840	240	3W 177 183 198	24V	2700 3000 4000	>90
		Br	6032-827 6032-830 6032-840	340	4,5W 250 260 281	24V	2700 3000 4000	>90
		Br	6033-827 6033-830 6033-840	440	6W 324 336 364	24V	2700 3000 4000	>90
		Br	6034-827 6034-830 6034-840	540	7,5W 397 413 447	24V	2700 3000 4000	>90
		Br	6035-827 6035-830 6035-840	640	9W 471 489 529	24V	2700 3000 4000	>90
		Br	6036-827 6036-830 6036-840	740	10,5W 544 566 612	24V	2700 3000 4000	>90
		Br	6037-827 6037-830 6037-840	840	12W 618 642 695	24V	2700 3000 4000	>90
		Br	6038-827 6038-830 6038-840	940	13,5W 691 719 777	24V	2700 3000 4000	>90
		Br	6039-827 6039-830 6039-840	1040	15W 765 795 860	24V	2700 3000 4000	>90
		Br	6040-827 6040-830 6040-840	1140	16W 838 871 943	24V	2700 3000 4000	>90
		Br	6041-827 6041-830 6041-840	1240	17,5W 912 948 1025	24V	2700 3000 4000	>90
		Br	6042-827 6042-840 6042-840	1340	19,5W 986 1024 1108	24V	2700 3000 4000	>90
		Br	6043-827 6043-830 6043-840	1440	21W 1059 1101 1191	24V	2700 3000 4000	>90
		Br	6044-827 6044-830 6044-840	1540	22,5W 1133 1177 1274	24V	2700 3000 4000	>90
		Br	6045-827 6045-830 6045-840	1640	24W 1206 1254 1356	24V	2700 3000 4000	>90
		Br	6046-827 6046-830 6046-840	1740	25,5W 1280 1330 1439	24V	2700 3000 4000	>90
		Br	6047-827 6047-830 6047-840	1840	27W 1353 1406 1522	24V	2700 3000 4000	>90
		Br	6048-827 6048-830 6048-840	1940	28,5W 1427 1483 1604	24V	2700 3000 4000	>90
		Br	6049-827 6049-830 6049-840	2040	30W 1500 1559 1687	24V	2700 3000 4000	>90



TAPE

ESEMPIO COMPONIBILITÀ
COMPONIBILITY EXAMPLE



		L [mm]	W	lm	V	K	CRI
0.593	Br 6050-827	2140	31,5W	1574	24V	2700	>90
	6050-830			1636		3000	
	6050-840			1770		4000	
0.621	Br 6051-827	2240	33W	1648	24V	2700	>90
	6051-830			1712		3000	
	6051-840			1852		4000	
0.650	Br 6052-827	2340	34,5W	1721	24V	2700	>90
	6052-830			1789		3000	
	6052-840			1935		4000	
0.676	Br 6053-827	2440	36W	1795	24V	2700	>90
	6053-830			1865		3000	
	6053-840			2018		4000	
0.705	Br 6054-827	2540	37,5W	1868	24V	2700	>90
	6054-830			1942		3000	
	6054-840			2101		4000	
0.732	Br 6055-827	2640	39W	1942	24V	2700	>90
	6055-830			2018		3000	
	6055-840			2183		4000	
0.760	Br 6056-827	2740	40,5W	2015	24V	2700	>90
	6056-830			2094		3000	
	6056-840			2266		4000	
0.787	Br 6057-827	2840	42W	2089	24V	2700	>90
	6057-830			2171		3000	
	6057-840			2349		4000	
0.815	Br 6058-827	2940	43,5W	2162	24V	2700	>90
	6058-830			2247		3000	
	6058-840			2431		4000	
0.843	Br 6059-827	3040	45W	2236	24V	2700	>90
	6059-830			2324		3000	
	6059-840			2514		4000	

OP. A richiesta - on request: Lunghezze customizzate su progetto - Customized lengths on project
Strip Led

ALIMENTATORI CONSIGLIATI - RECOMMENDED DRIVERS

644599	Alimentatore - Driver	10W	IP20
645038	Alimentatore - Driver	80W	IP20
645178	Alimentatore - Driver	100W	IP20

ACC. **KT6060** Modulo angolare di giunzione - Junction angle module

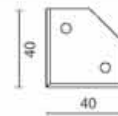

C180.....C00 | C270 — C90

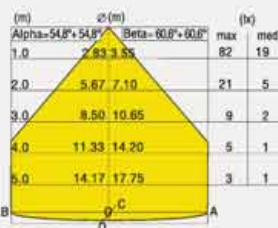
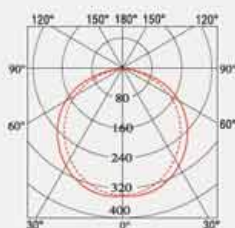







ALIMENTATORI-KIT RGB (se non in dotazione) da ordinare dalla sezione arancio - DRIVERS-RGB KITS (when not supplied) to be ordered from the section orange color

STRIP LED SMD 1

- Modulo Led su circuito flessibile con lato posteriore autoadesivo adatto a qualsiasi superficie fornito completo di cavallotto di fissaggio.
- Fornito in bobine (rolle) da 5 metri con possibilità di taglio secondo la tabella sottostante.
- Led module on flexible circuit with rear adhesive suitable for any surface supplied with clamp.
- Supplied in rolls of 5 meters with the possibility of cut according to the table below.



	 	L (m)	TAGLIO (mm) CUT (mm)	W (m)	lm (m)	V	K	CRI	LARGHEZZA (mm) WIDE (mm)	N. LED	 ALIMENTATORE - DRIVER
	645256-LBC	5	50	4,8W	204	12Vdc	3000	>90	8	300	644888 (10W 230-12V for max 2m.) 644889 (40W 230-12V for max 5m.) 644877 (105W 230-12V)
	645256-LBN				207		4000				
	645256-LBI				210		6000				
	645256-LBL				-		470nm				
	646164-LBC	5	100	4,8W	250	24Vdc	3000	>90	8	300	644599 (10W 230-24V for max 2m.) 645038 (60W 230-24V for max 5m.)
	646164-LBN				270		4000				
	645256-RGB	5	165	4,8W per canale for channel	500	24Vdc		-	10	300	644892-2 (for max 3m)



inside

C180 C00 C270 — C90

4,8W
— LBI
120°

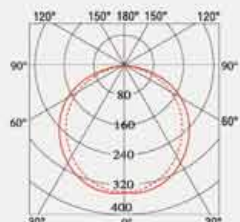

ALIMENTATORI-KIT RGB (se non in dotazione) da ordinare dalla sezione arancio - DRIVERS-RGB KITS (when not supplied) to be ordered from the section orange color





- Modulo Led ad alta efficienza su circuito flessibile con lato posteriore autoadesivo adatto a qualsiasi superficie fornito con cavetto di raccordo e accessori per fissaggio.
- Fornito in bobine (rolle) da 5 metri con possibilità di taglio secondo la tabella sottostante.

- Led module on flexible circuit with rear adhesive suitable for any surface with connection cable and fixing accessories.
- Supplied in rolls of 5 meters with the possibility of cut according to the table below.

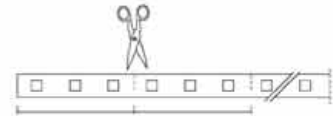
STRIP LED SMD 2-3



	 	L (m)	TAGLIO (mm) CUT (mm)	W (m)	lm (lm)	V	K	CRI	LARGHEZZA (mm) WIDE (mm)	N. LED	ALIMENTATORE - DRIVER
	STRIP 2	5	50	14,4W	1080	12Vdc	3200	>90	10	300	644877 (105W 230-12V)
	645452-LBC				1125		4100				644888 (10W 230-12V for max 0,6m.)
	645452-LBN				1170		5000				644889 (50W 230-12V for max 3m.)
	645452-LBL				1040		2700				645475 (100W 230-12V for max 5m. IP67)
645452-LBC27										645474 (100W 230-12V for max 5m. IP20)	
	646165-LBC	5	100	14,4W	1080	24Vdc	3200	>90	10	300	644599 (10W 230-24V for max 0,6m.)
	646165-LBN				1170		4100				645038 (60W 230-24V for max 4m.)
	646165-LBI				1220		5000				645216 (100W 230-24V for max 5m. IP67)
	STRIP 3	5	25	19W	1440	24Vdc	3200	>90	10	240	645038 (60W 230-24V for max 4m.)
	645777-LBC				1500		4100				645176 (100W 230-24V for max 5m.)
	645777-LBN				1560		5000				
645777-LBI											



IP 20



RG0



inside

ALIMENTATORI-KIT RGB (se non in dotazione) da ordinare dalla sezione arancio - DRIVERS-RGB KITS (when not supplied) to be ordered from the section orange color

STRIP LED SMD 1

- Modulo Led su circuito flessibile con lato posteriore autoadesivo adatto a qualsiasi superficie completo di cavallotto di fissaggio.
 - Versione IP65 con protezione in silicone morbido per basse temperature e raggi UV.
 - Fornito in bobine (rolle) da 5 metri con possibilità di taglio secondo la tabella sottostante.
- Led module on flexible circuit with rear adhesive suitable for any surface supplied with clamp.
 - IP65 version with silicone protection against low temperature and UV rays.
 - Supplied in rolls of 5 meters with the possibility of cut according to the table below.

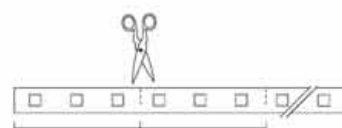

	120	L (m)	TAGLIO (mm) CUT (mm)	W (m)	lm (m)	V	K	CRI	LARGHEZZA (mm) WIDE (mm)	N. LED	ALIMENTATORE - DRIVER
	645256-LBC-IP	5	50	4,8W	204	12Vdc	3000	>90	10	300	644888 (10W 230-12V for max 2m.) 644889 (40W 230-12V for max 5m.) 644877 (105W 230-12V)
	645256-LBN-IP				207		4000				
	645256-LBI-IP				210		6000				
645256-LBL-IP	-	-	470nm								
646164-LBN-IP	5	100	4,8W	250	24Vdc	3000	>90	8	300	644599 (10W 230-24V for max 2m.) 645038 (60W 230-24V for max 5m.)	
	645256-RGB	5	100	4,8W per canale for channel	-	24Vdc		-	12	300	
	645258-RGB									600	



outside

C180 C00 C270 — C90

4,8W
...LBI
120°

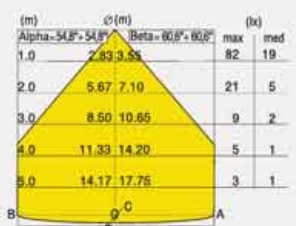
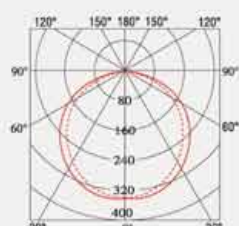

ALIMENTATORI-KIT RGB (se non in dotazione) da ordinare dalla sezione arancio - DRIVERS-RGB KITS (when not supplied) to be ordered from the section orange color

STRIP LED SMD 2-3



- Modulo Led ad alta efficienza su circuito flessibile con lato posteriore autoadesivo adatto a qualsiasi superficie fornito con cavetto di raccordo e accessori per fissaggio.
- Versione IP65 con protezione in silicone morbido per basse temperature e raggi UV.
- Fornito in bobine (rolle) da 5 metri con possibilità di taglio secondo la tabella sottostante.
- Led module on flexible circuit with rear adhesive suitable for any surface with connection cable and fixing accessories.
- IP65 version with silicone protection against low temperature and UV rays.
- Supplied in rolls of 5 meters with the possibility of cut according to the table below.

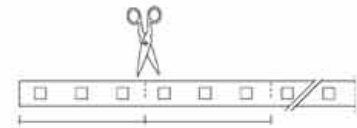

		L (m)	DAGLIO (mm) CUT (mm)	W (m)	lm (m)	V	K	CRI	LARGHEZZA (mm) WIDE (mm)	N. LED	ALIMENTATORE - DRIVER
645452-LBC-IP 645452-LBN-IP 645452-LBI-IP		5	50	14,4W	1080 1125 1170	12Vdc	3000 4000 5000	>80	10	300	644877 (105W 230-12V) 644888 (10W 230-12V for max 0,6m.) 644889 (50W 230-12V for max 3m.) 645475 (100W 230-12V for max 5m. IP67)
646165-LBC-IP 646165-LBN-IP 646165-LBI-IP		5	100	14,4W	1080 1170 1220	24Vdc	3200 4100 5000	>80	10	300	645038 (60W 230-24V for max 3m.) 645216 (100W 230-24V for max 5m. IP67)
646195-LBC 646195-LBN		5	100	22W	3000 4000	24Vdc	80 80	>80	10	0	



ALIMENTATORI-KIT RGB (se non in dotazione) da ordinare dalla sezione arancio - DRIVERS-RGB KITS (when not supplied) to be ordered from the section orange color





SISTEMI
SYSTEMS

inside

• FILE CONTINUE - LIGHT LINES



LINEA
296



TRAIL
PLAFONE
299



TRAIL
SOSPENSIONE
303



LINEAR SYSTEM
INCASSO
307



LINEAR SYSTEM
PARETE/PLAFONE
307



LINEAR SYSTEM
SOSPENSIONE
307



NEW
LIGHT CUT
325



LINEA

- Profilo portante elettrificato in lamiera di acciaio verniciato bianco in polveri epossidiche.
 - Testata in materiale termoplastico.
 - Vano ottico Led con lenti in PMMA.
 - Dissipatore passivo.
 - Temperatura esercizio: -20 +35°.
 - Cablaggio 7 conduttori con sezione 2,5 mm² (portata max 16 A).
 - Led durata utile: 50.000 (h) L80 B10 / L80 B50.
 - Consistenza cromatica: 3 SDCM.
 - Apparecchio conforme alle norme EN 60598-1.
- Electrified main structure in steel sheet, white painted in epoxy powders.
 - End caps in thermoplastic material.
 - Optic with PMMA lenses.
 - Passive heatsink.
 - Working temperature: -20 +35°.
 - 7-wire wiring, section 2.5 mm² (max load 16 A).
 - Led life: 50.000 (h) L80 B10 / L80 B50.
 - Chromatic consistency: 3 SDCM.
 - Compliance with EN 60598-1.



UGR ≤ 19

$$UGR = 8 \log_{10} \left[\frac{0,25}{L_b} \sum \frac{L^2 \sigma}{p^2} \right]$$

A PROFILO PORTANTE - MAIN STRUCTURE

		L (mm)
	4442	1415
	4444	2820

B VANO OTTICO - OPTIC TRAY

		LED					SISTEMA-SYSTEM			
		W	lm	V	K	CRI	W	lm	UGR	
	 FASCIO STANDARD STANDARD BEAM Br 4433-LBC 4433-LBN	36,2W	5850 6140	200-240V [500mA]	3000 4000	>90	40,2W	5745 6030	145 150	
		36,2W	5850 6140	200-240V [500mA]	3000 4000	>90	40,2W	5730 6020	143 150	
	 FASCIO DOPPIO ASIMMETRICO DOUBLE ASYMMETRIC BEAM Br 4435-LBC 4435-LBN	36,2W	5850 6140	200-240V [500mA]	3000 4000	>90	40,2W	5690 5970	143 148	
		36,2W	5850 6140	200-240V [500mA]	3000 4000	>90	40,2W	5755 6040	143 150	
		 FASCIO STANDARD STANDARD BEAM Br 4439-LBC 4439-LBN	72,5W	11700 12275	200-240V [500mA]	3000 4000	>90	76,5W	11490 12055	150 157
			72,5W	11700 12275	200-240V [500mA]	3000 4000	>90	76,5W	11470 12030	150 157
 FASCIO DOPPIO ASIMMETRICO DOUBLE ASYMMETRIC BEAM Br 4441-LBC 4441-LBN		72,5W	11700 12275	200-240V [500mA]	3000 4000	>90	76,5W	11380 11940	149 156	
		72,5W	11700 12275	200-240V [500mA]	3000 4000	>90	76,5W	11510 12077	150 158	

PER APPARECCHI IN EMERGENZA - PER APPARECCHI IN EMERGENZA



KIT EMERGENZA-EMERGENCY KIT

.../6029 1h

.../6029-3 3h

C ACCESSORI			
	6017	kit gancio sospensione standard colore bianco standard suspension hook kit white colour	
	6018	kit gancio sospensione a filo colore bianco con fune acciaio L. 3,1 m suspension hook kit white colour with steel cable kit L. 3,1 m	
	6019	kit gancio per sospensione colore bianco a catena hook kit for chain suspension white colour	
	6020	kit elemento di giunzione, n.6 pezzi junction element kit, n.6 pieces	A richiesta - On request: Copercchia cieco - Blind cover

DP	A richiesta - On request:	versioni - versions Utilizzare driver - Use drivers	646336 40W 646337 80W
		versioni potenziate - more powerful versions	53W - 8400lm - 4000K [L. 1415 mm] 105W - 16800lm - 4000K [L. 2820 mm]
		versioni con Led food - Led food version	

ESEMPIO ORDINE - ORDER EXAMPLE

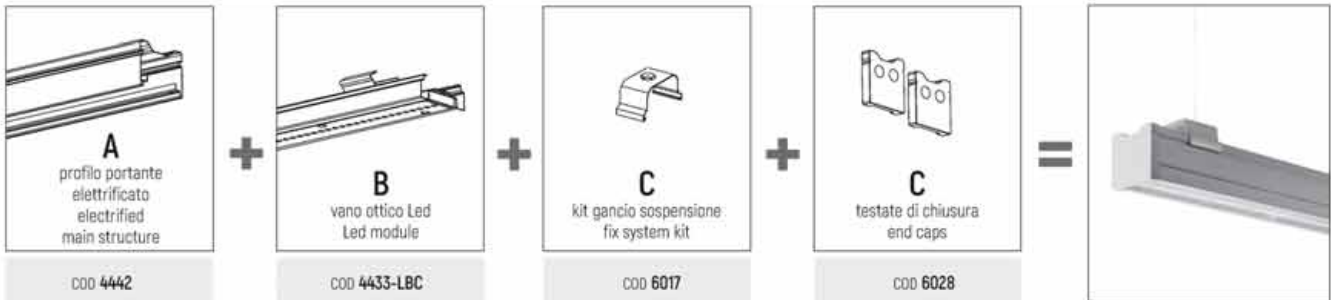

FASCIO STANDARD - STANDARD BEAM

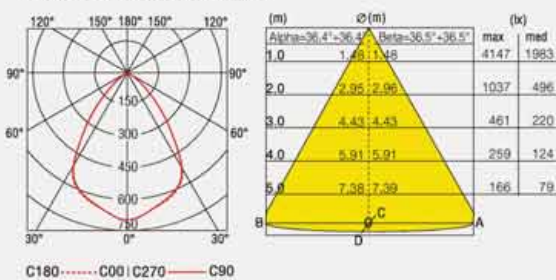

FASCIO DOPPIO ASIMMETRICO - DOUBLE ASYMMETRIC BEAM

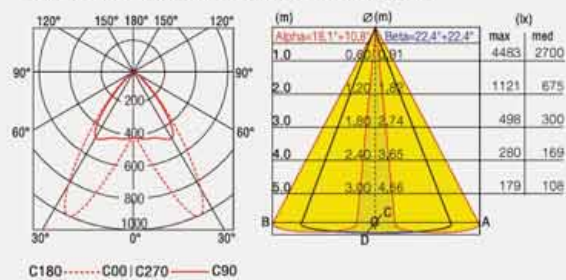

FASCIO DIFFUSO - DIFFUSED OPTIC

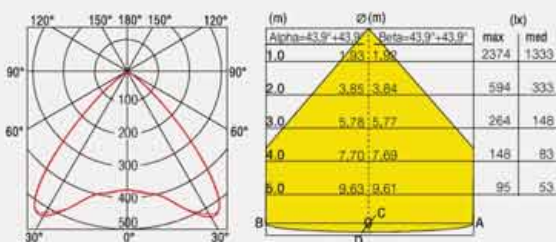

FASCIO ASIMMETRICO - ASYMMETRIC BEAM

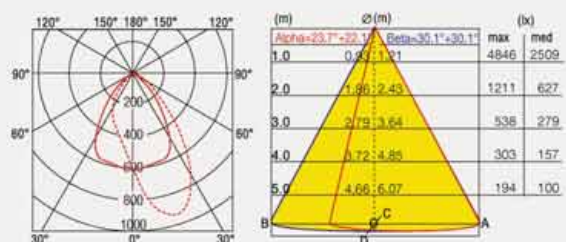

ALIMENTATORI-KIT RGB (se non in dotazione) da ordinare dalla sezione arancio - DRIVERS-RGB KITS (when not supplied) to be ordered from the section orange color



FASCIO CONTROLLATO
CONTROLLED BEAM

FASCIO DIFFONDEnte
DIFFUSED BEAM

N.B: A richiesta possibilità di utilizzare i 2 fasci nello stesso apparecchio.
NOTE: On request you can use the two different beams in the same fitting.

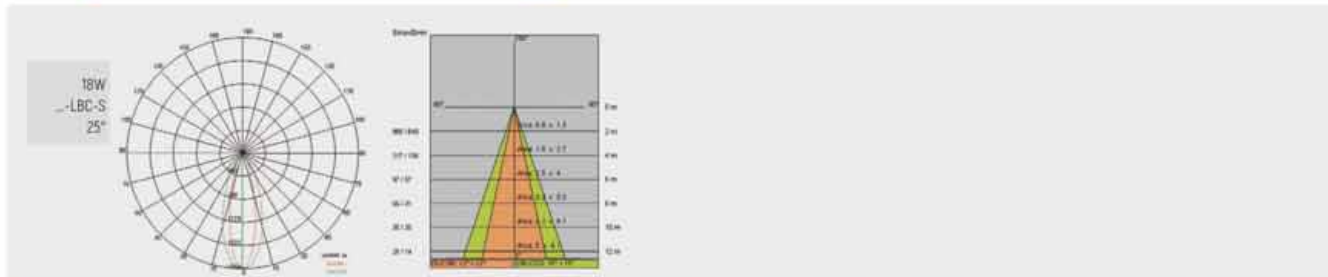

ALIMENTATORI-KIT RGB (se non in dotazione) da ordinare dalla sezione arancio - DRIVERS-RGB KITS (when not supplied) to be ordered from the section orange color



- Corpo in alluminio verniciato.
- Verniciatura in polveri di poliestere.
- Schermo in policarbonato.
- Alimentatore integrato.

- Aluminum body.
- Polyester powder coating.
- Polycarbonate screen.
- Integrated driver.

TRAIL PLAFONE

UGR <13

$$UGR = 8 \log_{10} \left[\frac{0,25}{L^2} \sum \frac{L^2 \theta}{p^2} \right]$$

Solo per fascio controllato
Only for controlled beam

FASCIO CONTROLLATO - CONTROLLED BEAM

12 LED



ON-OFF

Br 3730-LBC-P

W

lm

V

K

CR

W

lm

W

18W

1920

220-240V
[500mA]

3000

>90

21W

1551

74

Br 3730-LBN-P

18W

2112

220-240V
[500mA]

4000

>90

21W

1706

81

9Kg
2,15



DIM-DALI

Br 3730-LBC-P-DA

18W

1920

220-240V
[500mA]

3000

>90

21W

1551

74

Br 3730-LBN-P-DA

18W

2112

220-240V
[500mA]

4000

>90

21W

1706

81

24 LED

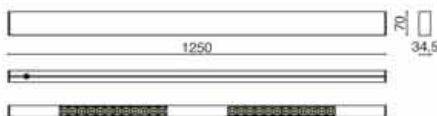

ON-OFF

Br 3733-LBC-P

36W

3840

220-240V
[500mA]

3000

>90

40W

3102

78

Br 3733-LBN-P

36W

4224

220-240V
[500mA]

4000

>90

40W

3412

85

9Kg
2,70



DIM-DALI

Br 3733-LBC-P-DA

36W

3840

220-240V
[500mA]

3000

>90

40W

3102

78

Br 3733-LBN-P-DA

36W

4224

220-240V
[500mA]

4000

>90

40W

3412

85

36 LED

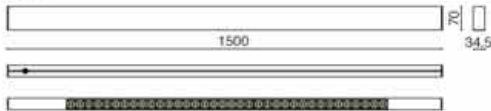

ON-OFF

Br 3736-LBC-P

54W

5760

220-240V
[500mA]

3000

>90

58W

4653

80

Br 3736-LBN-P

54W

6335

220-240V
[500mA]

4000

>90

58W

5119

88

9Kg
3,20



DIM-DALI

Br 3736-LBC-P-DA

54W

5760

220-240V
[500mA]

3000

>90

58W

4653

80

Br 3736-LBN-P-DA

54W

6335

220-240V
[500mA]

4000

>90

58W

5119

88

ACC. KIT BEND MICRO



A richiesta: kit Bend Micro con driver da inserire ai lati dell'apparecchio [n. 2 spot max per apparecchio]
On request: kit Bend Micro with driver to be installed on the fittings ends [n. 2 spot maximum for fitting]

ACC.

3193

Adattatore per binario 3 fasi, venduto già montato sull'apparecchio
Adapter for 3-phase track, sold already mounted on the fitting

Esempio di ordinazione
Ordering example

3730-LBC-P + 3193

ACC.

Br

3194

Kit attacco a parete - Wall mounting kit



OP.

A richiesta - On request:

potenze maggiorate max 36 Led
power increased max 36 Led

Versione **BIANCO DINAMICO - TUNABLE WHITE** version



TRAIL PLAFONE

- Corpo in alluminio verniciato.
- Verniciatura in polveri di poliestere.
- Schermo in policarbonato.
- Alimentatore integrato.

- Aluminum body.
- Polyester powder coating.
- Polycarbonate screen.
- Integrated driver.

FASCIO DIFFONDEnte - DIFFUSED BEAM

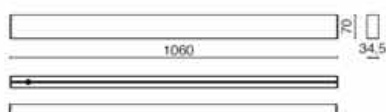

	LED					SISTEMA-SYSTEM		
	W	lm	V	K	CRI	W	lm	lm/W
ON-OFF								
Br 3740-LBC-P	26,8W	2460	220-240V 24V	3000	>90	31W	1737	56
Br 3740-LBN-P	26,8W	2660	220-240V 24V	4000	>90	31W	1878	58
DALI DIM-DALI								
Br 3740-LBC-P-DA	26,8W	2460	220-240V 24V	3000	>90	31W	1737	56
Br 3740-LBN-P-DA	26,8W	2660	220-240V 24V	3000	>90	31W	1878	58



ACC. 3193 Adattatore per binario 3 fasi, venduto già montato sull'apparecchio
Adapter for 3-phase track, sold already mounted on the fitting

Esempio di ordinazione
Ordering example: 3740-LBC-P + 3193

ACC. Br 3194 Kit attacco a parete - Wall mounting kit

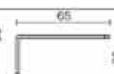

OP. A richiesta - On request: potenze maggiorate max 36 Led
power increased max 36 Led

Versione **BIANCO DINAMICO - TUNABLE WHITE** version



inside

54W
-LBC-S
120°

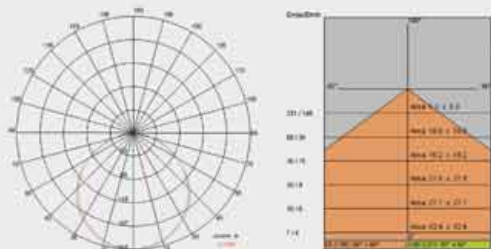

ALIMENTATORI-KIT RGB (se non in dotazione) da ordinare dalla sezione arancio - DRIVERS-RGB KITS (when not supplied) to be ordered from the section orange color



FASCIO DIFFONDEnte - DIFFUSED BEAM

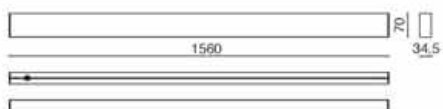

	LED					SISTEMA-SYSTEM		
	W	lm	V	K	CRI	W	lm	W
ON-OFF								
Br 3743-LBC-P	40,2W	3690	220-240V 24V	3000	>90	44,2W	2606	59
Br 3743-LBN-P	40,2W	3990	220-240V 24V	4000	>90	44,2W	2817	64
DALI DIM-DALI								
Br 3743-LBC-P-DA	40,2W	3690	220-240V 24V	3000	>90	44,2W	2606	59
Br 3743-LBN-P-DA	40,2W	3990	220-240V 24V	4000	>90	44,2W	2817	64

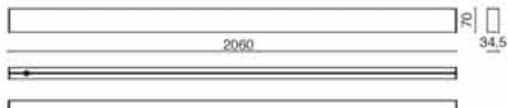

ON-OFF								
Br 3746-LBC-P	53,6W	4920	220-240V 24V	3000	>90	58W	3474	60
Br 3746-LBN-P	53,6W	5320	220-240V 24V	4000	>90	58W	3756	65
DALI DIM-DALI								
Br 3746-LBC-P-DA	53,6W	4920	220-240V 24V	3000	>90	58W	3474	60
Br 3746-LBN-P-DA	53,6W	5320	220-240V 24V	4000	>90	58W	3756	65



C180 C00 | C270 — C90

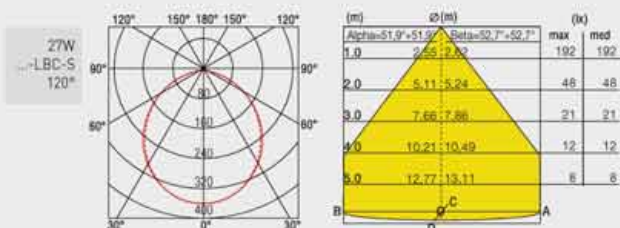

ALIMENTATORI-KIT RGB (se non in dotazione) da ordinare dalla sezione arancio - DRIVERS-RGB KITS (when not supplied) to be ordered from the section orange color

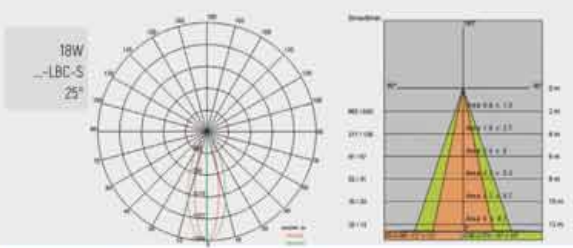

ALIMENTATORI-KIT RGB (se non in dotazione) da ordinare dalla sezione arancio - DRIVERS-RGB KITS (when not supplied) to be ordered from the section orange color

TRAIL SOSPENSIONE



- Corpo in alluminio verniciato bianco o nero, ottiche bianche.
- Verniciatura in polveri di poliestere.
- Schermo in policarbonato.
- Cavo di sospensione L. 3m.
- Cavo di alimentazione L. 2,5m.
- Alimentatore integrato.

- Body white or black painted aluminum, white optics.
- Polyester powder coating.
- Polycarbonate screen.
- Suspension cable L. 3m.
- Power cable L. 2,5m.
- Integrated driver.

UGR <math><13</math>

$$UGR = 8 \log_{10} \left[\frac{0,25}{L_h} \sum \frac{L^2 \rho}{p^3} \right]$$

Solo per fascio controllato
Only for controlled beam

FASCIO CONTROLLATO - CONTROLLED BEAM

12 LED



LED

W

lm

V

K

CRI

SISTEMA-SYSTEM

W

lm

W

ON-OFF

Br

3730-LBC-S

18W

1920

220-240V

[500mA]

3000

>90

21W

1551

74

Br

3730-LBN-S

18W

2112

220-240V

[500mA]

4000

>90

21W

1706

81

Kg
2,15

Br

3730-LBC-S-DA

18W

1920

220-240V

[500mA]

3000

>90

21W

1551

74

Br

3730-LBN-S-DA

18W

2112

220-240V

[500mA]

4000

>90

21W

1706

81

24 LED



ON-OFF

Br

3733-LBC-S

36W

3840

220-240V

[500mA]

3000

>90

40W

3102

78

Br

3733-LBN-S

36W

4224

220-240V

[500mA]

4000

>90

40W

3412

85

Kg
2,70

Br

3733-LBC-S-DA

36W

3840

220-240V

[500mA]

3000

>90

40W

3102

78

Br

3733-LBN-S-DA

36W

4224

220-240V

[500mA]

4000

>90

40W

3412

85

36 LED

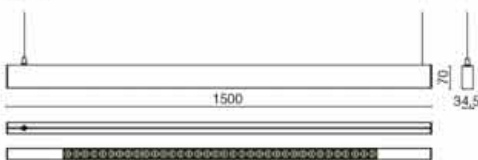

ON-OFF

Br

3736-LBC-S

54W

5760

220-240V

[500mA]

3000

>90

58W

4635

80

Br

3736-LBN-S

54W

6336

220-240V

[500mA]

4000

>90

58W

5119

88

Kg
3,20

Br

3736-LBC-S-DA

54W

5760

220-240V

[500mA]

3000

>90

58W

4635

80

Br

3736-LBN-S-DA

54W

6336

220-240V

[500mA]

4000

>90

58W

5119

88

ACC. KIT BEND MICRO

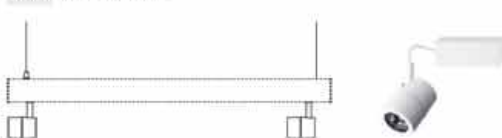
A richiesta: kit Bend Micro con driver da inserire ai lati dell'apparecchio (n. 2 spot max per apparecchio)
On request: kit Bend Micro with driver to be installed on side's fittings (n. 2 spot maximum for fitting)

OP:

A richiesta - On request: potenze maggiorate max 36 Led - power increased max 36 Led

Versione **BIANCO DINAMICO** - TUNABLE WHITE version

ACC.

3191 Rosone - Canapy

N.B. A richiesta possibilità di utilizzare i 2 fasci nello stesso apparecchio.
NOTE: On request you can use all two beams in the same fitting.

IP 20

*Valori riferiti agli apparecchi con fascio luminoso da $\Delta 80$ - Value for fittings with beam angle $\Delta 80$

ALIMENTATORI-KIT RGB (se non in dotazione) da ordinare dalla sezione arancio - DRIVERS-RGB KITS (when not supplied) to be ordered from the section orange color





TRAIL SOSPENSIONE

- Corpo in alluminio verniciato bianco o nero, ottiche bianche.
- Verniciatura in polveri di poliestere.
- Schermo in policarbonato.
- Cavo di sospensione L. 3m.
- Cavo di alimentazione L. 2,5m.
- Alimentatore integrato.

- Body white or black painted aluminum, white optics.
- Polyester powder coating.
- Polycarbonate screen.
- Suspension cable L. 3m.
- Power cable L. 2,5m.
- Integrated driver.



FASCIO DIFFONDEnte - DIFFUSED BEAM	LED	SISTEMA-SYSTEM								
		W	lm	lm/W						
	ON-OFF	W	lm	V	K	CRI	W	lm	lm/W	
	Br 3740-LBC-S	26,8W	2460	220-240V 24V	3000	>90	31W	1737	56	
	Br 3740-LBN-S	26,8W	2660	220-240V 24V	4000	>90	31W	1878	58	
	DALI DIM-DALI	Br 3740-LBC-S-DA	26,8W	2460	220-240V 24V	3000	>90	31W	1737	56
	Br 3740-LBN-S-DA	26,8W	2660	220-240V 24V	4000	>90	31W	1878	58	

	ON-OFF	W	lm	V	K	CRI	W	lm	lm/W	
	Br 3743-LBC-S	40,2W	3690	220-240V 24V	3000	>90	44,2W	2606	59	
	Br 3743-LBN-S	40,2W	3990	220-240V 24V	4000	>90	44,2W	2817	64	
	DALI DIM-DALI	Br 3743-LBC-S-DA	40,2W	3690	220-240V 24V	3000	>90	44,2W	2606	59
	Br 3743-LBN-S-DA	40,2W	3990	220-240V 24V	4000	>90	44,2W	2817	64	



inside

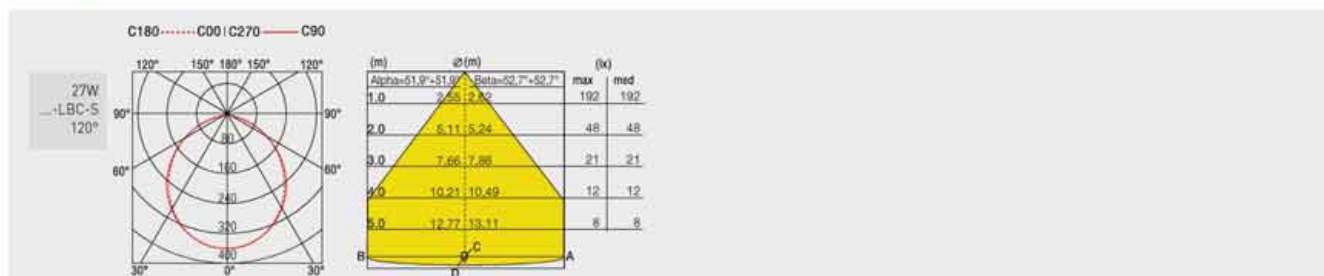

ALIMENTATORI-KIT RGB (se non in dotazione) da ordinare dalla sezione arancio - DRIVERS-RGB KITS (when not supplied) to be ordered from the section orange color



FASCIO DIFFONDEnte - DIFFUSED BEAM

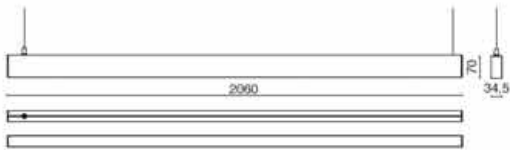

	LED					SISTEMA-SYSTEM		
	W	lm	V	K	CRI	W	lm	lm/W
ON-OFF								
Br 3746-LBC-S	53,6W	4920	220-240V 24V	3000	>90	58W	3474	60
Br 3746-LBN-S	53,6W	5320	220-240V 24V	4000	>90	58W	3756	65
DALI DIM-DALI								
Br 3746-LBC-S-DA	53,6W	4920	220-240V 24V	3000	>90	58W	3474	60
Br 3746-LBN-S-DA	53,6W	5320	220-240V 24V	4000	>90	58W	3756	65



ACC 3193 Adattatore per binario 3 fasi, venduto già montato sull'apparecchio
Adapter for 3-phase track, sold already mounted on the fitting

Esempio di ordinazione
Ordering example: **3740-LBC-S + 3193**

ACC Br 3194 Kit attacco a parete - Wall mounting kit



3191 Rosone - Canopy

DP: A richiesta - On request: potenze maggiorate max 36 Led
power increased max 36 Led

Versione **BIANCO DINAMICO - TUNABLE WHITE** version

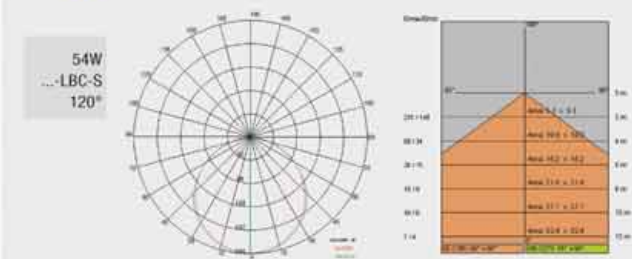

ALIMENTATORI-KIT RGB (se non in dotazione) da ordinare dalla sezione arancio - DRIVERS-RGB KITS (when not supplied) to be ordered from the section orange color



LUNGHEZZE - LENGTH

2815 mm

1975 mm

1415 mm

855 mm

LARGHEZZA - WIDTH

82 mm

64 mm

43.5 mm

110 mm

90 mm

70 mm

ALTEZZA - HEIGHT

LINEAR SYSTEM

LINEAR SYSTEM è un sistema a sviluppo lineare.

Il suo design estremamente pulito e proporzionato consente, grazie alla sua emissione luminosa, di rendere lo spazio il vero protagonista della scena architettonica.

Una linea luminosa in libertà per creare infinite ed originali combinazioni.

- > **3 misure differenti**
 - corpo piccolo 43,5 x h. 70 mm
 - corpo medio 64 x h. 90 mm
 - corpo grande 82 x h. 110 mm
- 4 lunghezze 855, 1415, 1975, 2815 mm
- > **Sistema completo:**
incasso, parete, plafone e sospensione
- > **Luce diretta e indiretta, simmetrica e asimmetrica**
- > **Sistema modulare - linea continua**
per coprire ampie lunghezze e sistema angolare
- > **Nessuna vite a vista**
- > **CRI >90**
- > **UGR <19**

LINEAR SYSTEM is a linear development system.

Its extremely clean and proportionate design allows, thanks to its light emission, to make the space the true protagonist of the architectural scene.

A luminous line to freely create infinite and original combinations.

- > **3 different sizes**
 - small body 43.5 x h. 70 mm
 - medium body 64 x h. 90 mm
 - large body 82 x h. 110 mm
- 4 lengths 855, 1415, 1975, 2815 mm
- > **Complete system:**
recessed, wall, ceiling and suspension
- > **Direct and indirect light symmetrical and asymmetrical**
- > **Modular system - continuous line**
to cover large lengths and angular system
- > **No visible screws**
- > **CRI >90**
- > **UGR <19**

schermo microprismatico - microprismatic screen

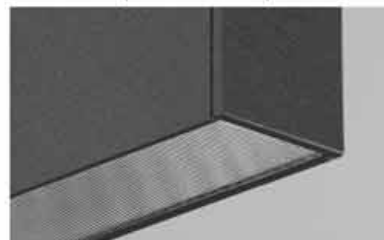

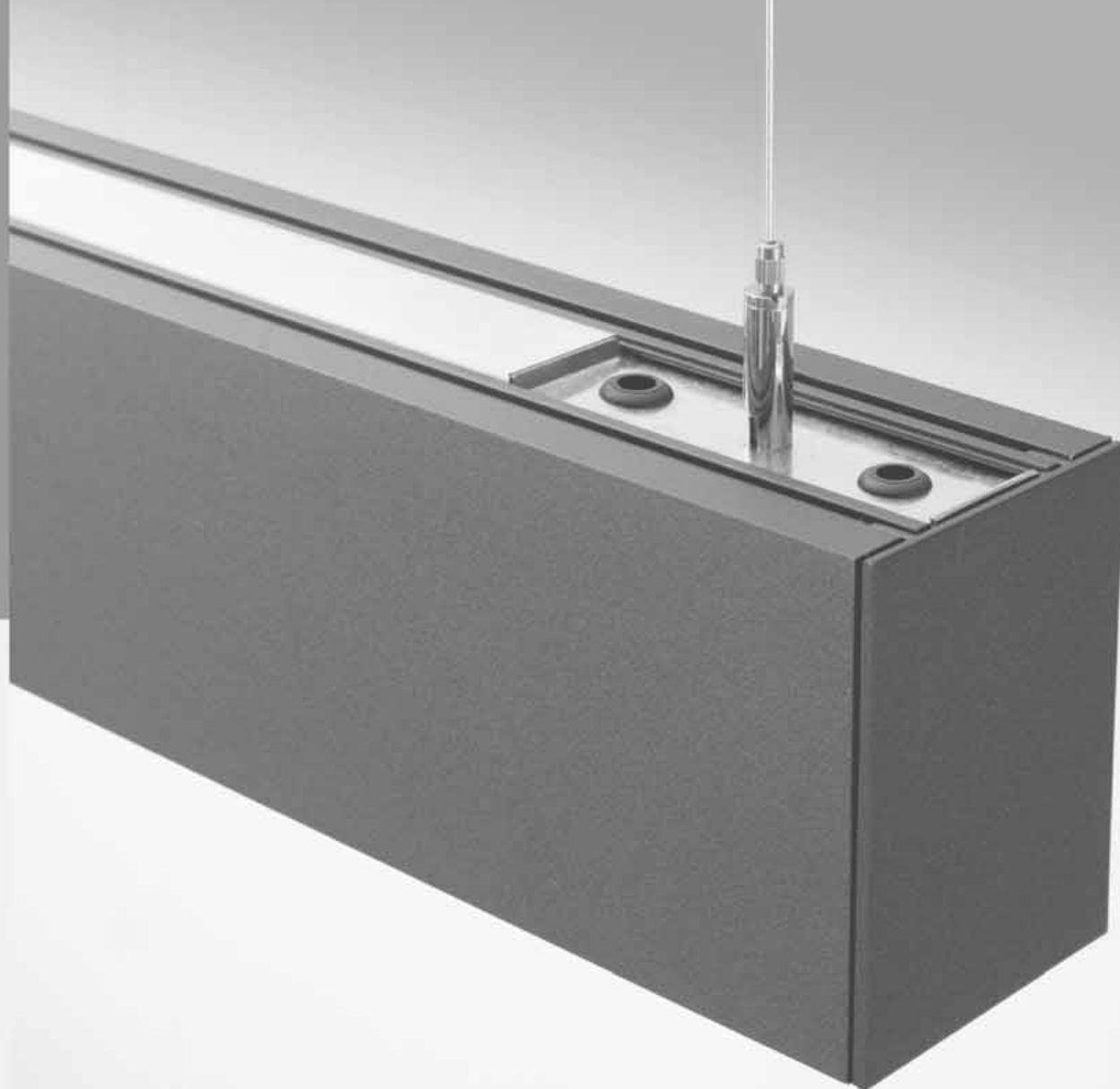

Sistema facile e pratico, permette di ottenere la configurazione adatta a soddisfare ogni progetto, semplicemente scegliendo l'accessorio da incasso, parete, plafone o sospensione.

Easy and practical system, it allows to obtain the configuration suitable to satisfy every project, simply choosing the built-in, wall, ceiling or suspension accessory.

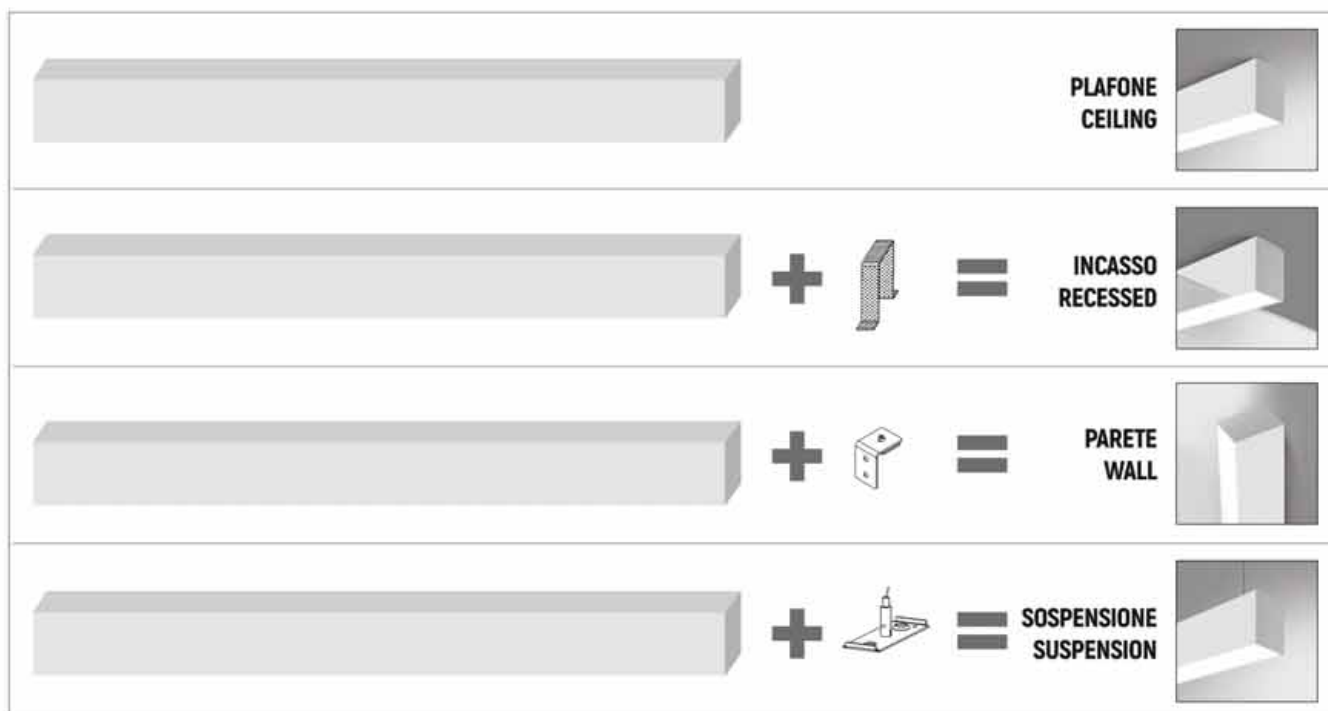

APPLICAZIONI - APPLICATION

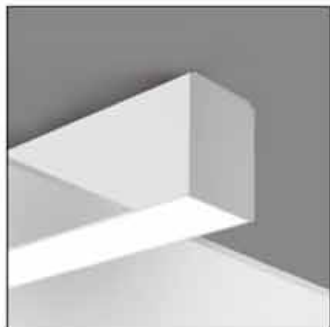

INCASSO
RECESSED



PARETE/PLAFONE
WALL/CEILING



SOSPENSIONE
SUSPENSION

LUCE - LIGHT



LUCE DIRETTA
DIRECT LIGHT



LUCE DIRETTA E
INDIRETTA
DIRECT AND
INDIRECT LIGHT



LUCE SIMMETRICA
SYMMETRIC LIGHT

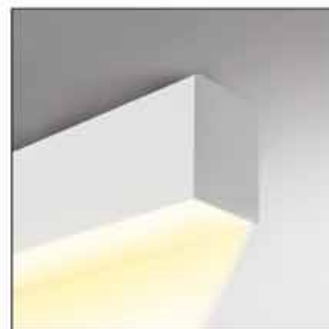

LUCE ASIMMETRICA
ASYMMETRIC LIGHT

LINEA CONTINUA - CONTINUOUS LINE



CONNESSIONE ANGOLARE - ANGULAR CONNECTION

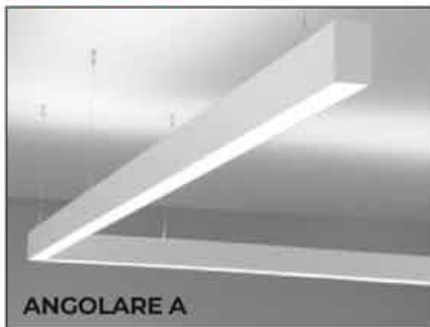

ANGOLARE A



ANGOLARE AM

LINEAR SYSTEM

- Struttura in estruso di alluminio verniciato.
- Testata chiusura in alluminio verniciato, senza viti a vista.
- Verniciatura in polveri di poliestere.
- Schermo in policarbonato opale.
- Led durata utile: 50.000 (h) L80 B20.
- Schermo microprismatizzato in metacrilato.

- Extruded aluminium painted structure.
- End cap in painted aluminium painted, no visible screws.
- Polyester powder coating.
- Opale polycarbonate diffuser.
- Led life: 50.000 (h) L80 B20.
- Microprismatic methacrylate screen.









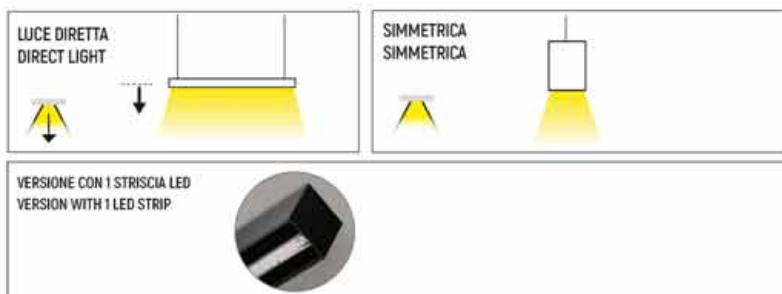

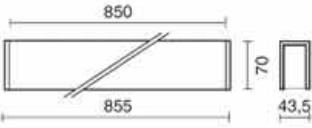

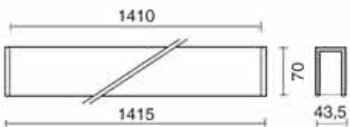
LUCE DIRETTA DIRECT LIGHT

43,5 x h. 70 mm

- INCASSO - RECESSED
- PARETE - WALL
- PLAFONE - CEILING
- SOSPENSIONE - SUSPENSION

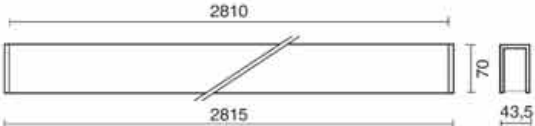

	LED	LED							
		W	lm	V	K	CRI	W	lm	lm/W
 <p>L 850 mm = solo apparecchio - only fixture L 855 mm = apparecchio + testate - fixture + caps</p>	ON-OFF								
	Br 3350-LBC-D9	26W	3743	220-240V (500mA)	3000	>90	30W	2392	80
	Ne 3351-LBC-D9								
	Br 3350-LBN-D9	26W	3900	220-240V (500mA)	4000	>90	30W	2492	83
	Ne 3351-LBN-D9								
	 	Br 3352-LBC-D9	26W	3743	220-240V (500mA)	3000	>90	30W	2391
Ne 3353-LBC-D9									
Br 3352-LBN-D9	26W	3900	220-240V (500mA)	4000	>90	30W	2492	83	
Ne 3353-LBN-D9									
 <p>L 1410 mm = solo apparecchio - only fixture L 1415 mm = apparecchio + testate - fixture + caps</p>	ON-OFF								
	Br 3350-LBC-D14	43W	6238	220-240V (500mA)	3000	>90	47W	3986	84
	Ne 3351-LBC-D14								
	Br 3350-LBN-D14	43W	6500	220-240V (500mA)	4000	>90	47W	4154	88
	Ne 3351-LBN-D14								
	 	Br 3352-LBC-D14	43W	6238	220-240V (500mA)	3000	>90	47W	3986
Ne 3353-LBC-D14									
Br 3352-LBN-D14	43W	6500	220-240V (500mA)	4000	>90	47W	4154	88	
Ne 3353-LBN-D14									
 <p>L 1970 mm = solo apparecchio - only fixture L 1975 mm = apparecchio + testate - fixture + caps</p>	ON-OFF								
	Br 3350-LBC-D19	61W	8733	220-240V (500mA)	3000	>90	64W	5580	87
	Ne 3351-LBC-D19								
	Br 3350-LBN-D19	61W	9100	220-240V (500mA)	4000	>90	64W	5815	91
	Ne 3351-LBN-D19								
	 	Br 3352-LBC-D19	61W	8733	220-240V (500mA)	3000	>90	64W	5580
Ne 3353-LBC-D19									
Br 3352-LBN-D19	61W	9100	220-240V (500mA)	4000	>90	64W	5815	91	
Ne 3353-LBN-D19									
 <p>L 2810 mm = solo apparecchio - only fixture L 2815 mm = apparecchio + testate - fixture + caps</p>	ON-OFF								
	Br 3350-LBC-D28	87W	12475	220-240V (500mA)	3000	>90	90W	7972	89
	Ne 3351-LBC-D28								
	Br 3350-LBN-D28	87W	13000	220-240V (500mA)	4000	>90	90W	8307	92
	Ne 3351-LBN-D28								
	 	Br 3352-LBC-D28	87W	12475	220-240V (500mA)	3000	>90	90W	7972
Ne 3353-LBC-D28									
Br 3352-LBN-D28	87W	15000	220-240V (500mA)	4000	>90	90W	8307	92	
Ne 3353-LBN-D28									

LINEAR SYSTEM

LUCE DIRETTA + INDIRECTA DIRECT + INDIRECT LIGHT





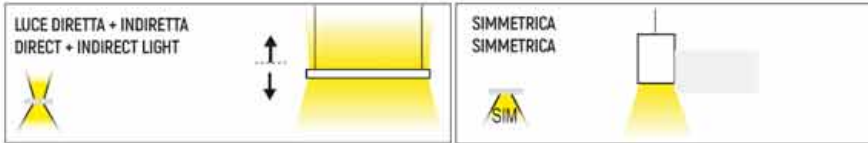





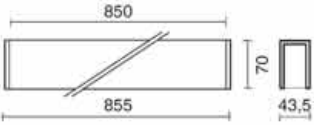



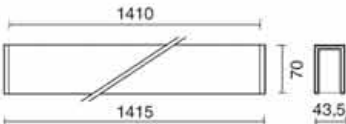



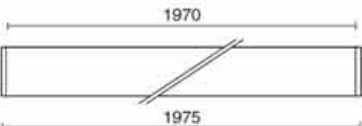

43,5 x h. 70 mm

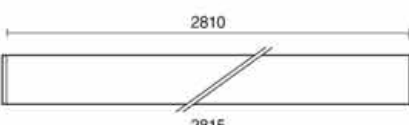
- PARETE - WALL
- SOSPENSIONE - SUSPENSION



VERSIONE CON 1 STRISCIA LED
VERSION WITH 1 LED STRIP



	ON-OFF	Br	Ne	DIRETTA-DIRECT	INDIRETTA-INDIRECT	LED			SISTEMA-SYSTEM					
						W	lm	V	K	CRI	W	lm	W	
 <p>L 850 mm = solo apparecchio - only fixture L 855 mm = apparecchio + testate - fixture + caps</p>		 DALI		Br 3350-LBC-DE9	DIRETTA-DIRECT	26W	3743	220-240V	3000	>90	30W	2392	100	
		Ne 3351-LBC-DE9	INDIRETTA-INDIRECT	9W	1248	[500mA]	9W	898						
		 DALI		Br 3350-LBN-DE9	DIRETTA-DIRECT	26W	3900	220-240V	4000	>90	30W	2492	104	
		Ne 3351-LBN-DE9	INDIRETTA-INDIRECT	9W	1300	[500mA]	9W	936						
	 <p>L 1410 mm = solo apparecchio - only fixture L 1415 mm = apparecchio + testate - fixture + caps</p>		 DALI		Br 3350-LBC-DE14	DIRETTA-DIRECT	43W	6238	220-240V	3000	>90	47W	3986	104
			Ne 3351-LBC-DE14	INDIRETTA-INDIRECT	17W	2495	[500mA]	17W	1771					
		 DALI		Br 3350-LBN-DE14	DIRETTA-DIRECT	43W	6500	220-240V	4000	>90	47W	4154	108	
		Ne 3351-LBN-DE14	INDIRETTA-INDIRECT	17W	2600	[500mA]	17W	1845						
 <p>L 1970 mm = solo apparecchio - only fixture L 1975 mm = apparecchio + testate - fixture + caps</p>			 DALI		Br 3350-LBC-DE19	DIRETTA-DIRECT	61W	8733	220-240V	3000	>90	68W	5580	106
			Ne 3351-LBC-DE19	INDIRETTA-INDIRECT	25W	3742	[500mA]	25W	2644					
		 DALI		Br 3350-LBN-DE19	DIRETTA-DIRECT	61W	9100	220-240V	4000	>90	68W	5815	110	
		Ne 3351-LBN-DE19	INDIRETTA-INDIRECT	25W	3940	[500mA]	25W	2755						
	 <p>L 2810 mm = solo apparecchio - only fixture L 2815 mm = apparecchio + testate - fixture + caps</p>		 DALI		Br 3350-LBC-DE28	DIRETTA-DIRECT	87W	12475	220-240V	3000	>90	94W	7972	104
			Ne 3351-LBC-DE28	INDIRETTA-INDIRECT	34W	4990	[500mA]	34W	3541					
		 DALI		Br 3350-LBN-DE28	DIRETTA-DIRECT	87W	13000	220-240V	4000	>90	94W	8307	109	
		Ne 3351-LBN-DE28	INDIRETTA-INDIRECT	34W	5200	[500mA]	34W	3691						
		 DALI		Br 3352-LBC-DE28	DIRETTA-DIRECT	87W	12475	220-240V	3000	>90	94W	7972	104	
		Ne 3353-LBC-DE28	INDIRETTA-INDIRECT	34W	4990	[500mA]	34W	3541						
	 DALI		Br 3352-LBN-DE28	DIRETTA-DIRECT	87W	13000	220-240V	4000	>90	94W	8307	109		
	Ne 3353-LBN-DE28	INDIRETTA-INDIRECT	34W	5200	[500mA]	34W	3691							











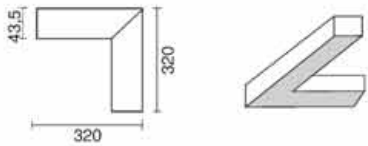

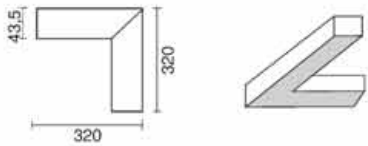

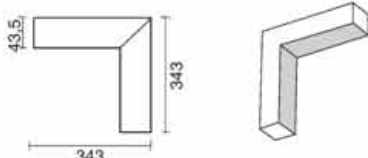
LINEAR SYSTEM

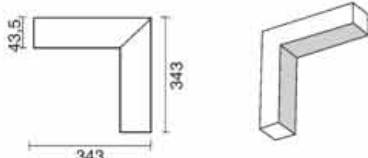

ACCESSORI - ACCESSORIES

43,5 x h. 70 mm

		LED					SISTEMA-SYSTEM		
		W	lm	V	K	CRI	W	lm	lm/W
MODULO ANGOLARE A INCASSO/PLAFONE RECESSED/CEILING ANGLE MODULE 	ON-OFF								
	Br 3354-LBC-A	17W	2496	220-240V	3000	>90	20W	1595	80
	Ne 3355-LBC-A			[500mA]					
	Br 3354-LBN-A	17W	2600	220-240V	4000	>90	20W	1661	83
	Ne 3355-LBN-A			[500mA]					
 DALI MODULO ANGOLARE A INCASSO/PLAFONE RECESSED/CEILING ANGLE MODULE 	ON-OFF								
	Br 3354-LBCA-DA	17W	2496	220-240V	3000	>90	20W	1595	80
	Ne 3355LBCA-DA			[500mA]					
	Br 3354LBN-DA	17W	2600	220-240V	4000	>90	20W	1661	83
	Ne 3355LBN-DA			[500mA]					
 DALI MODULO ANGOLARE A PARETE/PLAFONE WALL/CEILING ANGLE MODULE 	ON-OFF								
	Br 3354-LBC-AM	17W	2496	220-240V	3000	>90	20W	1595	80
	Ne 3355-LBC-AM			[500mA]					
	Br 3354-LBN-AM	17W	2600	220-240V	4000	>90	20W	1661	83
	Ne 3355-LBN-AM			[500mA]					
 DALI MODULO ANGOLARE A PARETE/PLAFONE WALL/CEILING ANGLE MODULE 	ON-OFF								
	Br 3354LBCAM-DA	17W	2496	220-240V	3000	>90	20W	1595	80
	Ne 3355LBCAM-DA			[500mA]					
	Br 3354LBNAM-DA	17W	2600	220-240V	4000	>90	20W	1661	83
	Ne 3355LBNAM-DA			[500mA]					
KIT FISSAGGIO A INCASSO (CARTONGESSO $\Delta = \pm 10$ mm) RECESSED FIXING KIT (PLASTERBOARD $\Delta = \pm 10$ mm) 		980016-I-43							
KIT FISSAGGIO A PARETE WALL FIXING KIT 		980017-P-43							
KIT SOSPENSIONE A FILO - Ø 1,2 mm - LUNGH. 3 m WIRE SUSPENSION KIT - Ø 1,2 mm - LENGTH 3 m 		980012-S-43							
KIT DI GIUNZIONE ELETTROMECCANICA ELECTROMECHANICAL JUNCTION KIT 		980019							
KIT BLOCCACAVO SOSPENSIONE (ROSONE) CABLE LOCK KIT SUSPENSION (CANOPY) 	Br 699907 Ne 980052								
KIT N. 2 TESTATE DI CHIUSURA IN ALLUMINIO SENZA VITI A VISTA KIT N. 2 END CAPS ALUMINIUM PAINTED NO VISIBLE SCREWS 	Br 98001306-T-43 Ne 98001307-T-43								

OP. A richiesta - On request: Schermo policarbonato opale - Opal polycarbonate screen



ALIMENTATORI-KIT RGB (se non in dotazione) da ordinare dalla sezione arancio - DRIVERS-RGB KITS (when not supplied) to be ordered from the section orange color

LINEAR SYSTEM



- Struttura in estruso di alluminio verniciato.
- Testata chiusura in alluminio verniciato, senza viti a vista.
- Verniciatura in polveri di poliestere.
- Schermo in policarbonato opale.
- Led durata utile: 50.000 (h) L80 B20.
- Schermo microprismatizzato in metacrilato.

- Extruded aluminium painted structure.
- End cap in aluminium painted, no visible screws.
- Polyester powder coating.
- Opale polycarbonate diffuser.
- Led life: 50.000 (h) L80 B20.
- Microprismatic methacrylate screen.

LUCE DIRETTA DIRECT LIGHT

64 x h. 90 mm

- **INCASSO - RECESSED**
- **PARETE - WALL**
- **PLAFONE - CEILING**
- **SOSPENSIONE - SUSPENSION**

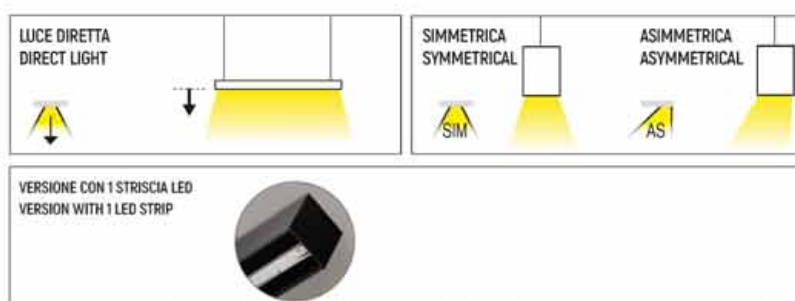

	LED	SISTEMA-SYSTEM		
		W	lm	lm/W
ON-OFF				
Br 3360-LBC-D9		26W	5743	220-240V [500mA]
Ne 3361-LBC-D9		26W	5743	3000 >90
Br 3360BCD9-AS		26W	5743	220-240V [500mA]
Ne 3361BCD9-AS		26W	5743	3000 >90
Br 3360-LBN-D9		26W	3900	220-240V [500mA]
Ne 3361-LBN-D9		26W	3900	4000 >90
Br 3360BND9-AS		26W	3900	220-240V [500mA]
Ne 3361BND9-AS		26W	3900	4000 >90
Br 3362-LBC-D9		26W	5743	220-240V [500mA]
Ne 3363-LBC-D9		26W	5743	3000 >90
Br 3360BCD9AS-D		26W	5743	220-240V [500mA]
Ne 3361BCD9AS-D		26W	5743	3000 >90
Br 3362-LBN-D9		26W	3900	220-240V [500mA]
Ne 3363-LBN-D9		26W	3900	4000 >90
Br 3360BND9AS-D		26W	3900	220-240V [500mA]
Ne 3361BND9AS-D		26W	3900	4000 >90

L 850 mm = solo apparecchio - only fixture
L 855 mm = apparecchio + testate - fixture + caps

LINEAR SYSTEM

	ON-OFF	Br	Ne	Icon	LED					SISTEMA-SYSTEM			
					W	lm	V	K	CRI	W	lm	$\frac{lm}{W}$	
<p>L 1410 mm = solo apparecchio - only fixture L 1415 mm = apparecchio + testate - fixture + caps</p>	ON-OFF	3360-LBC-D14	3361-LBC-D14	SIM	43W	6238	220-240V [500mA]	3000	>90	47W	3840	82	
	Br	3360-LBC-D14	3361-LBC-D14										
	AS	3360BCD14-AS	3361BCD14-AS	AS	43W	6238	220-240V [500mA]	3000	>90	47W	3240	69	
	Br	3360BCD14-AS	3361BCD14-AS										
	AS	3360LBN-D14	3361LBN-D14	SIM	43W	6500	220-240V [500mA]	4000	>90	47W	4000	88	
	Br	3360LBN-D14	3361LBN-D14										
	AS	3360BND14-AS	3361BND14-AS	AS	43W	6500	220-240V [500mA]	4000	>90	47W	3360	72	
	Br	3360BND14-AS	3361BND14-AS										
		DALI	3362-LBC-D14	3363-LBC-D14	SIM	43W	6238	220-240V [500mA]	3000	>90	47W	3840	82
		Br	3362-LBC-D14	3363-LBC-D14									
		AS	3360BCD14AS-D	3361BCD14AS-D	AS	43W	6238	220-240V [500mA]	3000	>90	47W	3240	69
		Br	3360BCD14AS-D	3361BCD14AS-D									
AS		3362-LBN-D14	3363-LBN-D14	SIM	43W	6500	220-240V [500mA]	4000	>90	47W	4000	85	
Br		3362-LBN-D14	3363-LBN-D14										
AS		3360BND14AS-D	3361BND14AS-D	AS	43W	6500	220-240V [500mA]	4000	>90	47W	3360	72	
Br		3360BND14AS-D	3361BND14AS-D										
<p>L 1970 mm = solo apparecchio - only fixture L 1975 mm = apparecchio + testate - fixture + caps</p>		ON-OFF	3360-LBC-D19	3361-LBC-D19	SIM	61W	8733	220-240V [500mA]	3000	>90	68W	5370	79
		Br	3360-LBC-D19	3361-LBC-D19									
		AS	3360BCD19-AS	3361BCD19-AS	AS	61W	8733	220-240V [500mA]	3000	>90	68W	4540	67
		Br	3360BCD19-AS	3361BCD19-AS									
	AS	3360LBN-D19	3361LBN-D19	SIM	61W	9100	220-240V [500mA]	4000	>90	68W	5600	82	
	Br	3360LBN-D19	3361LBN-D19										
	AS	3360BND19-AS	3361BND19-AS	AS	61W	9100	220-240V [500mA]	4000	>90	68W	4730	70	
	Br	3360BND19-AS	3361BND19-AS										
		DALI	3362-LBC-D19	3363-LBC-D19	SIM	61W	8733	220-240V [500mA]	3000	>90	68W	5370	79
		Br	3362-LBC-D19	3363-LBC-D19									
		AS	3360BCD19AS-D	3361BCD19AS-D	AS	61W	8733	220-240V [500mA]	3000	>90	68W	4540	67
		Br	3360BCD19AS-D	3361BCD19AS-D									
AS		3362-LBN-D19	3363-LBN-D19	SIM	61W	9100	220-240V [500mA]	4000	>90	68W	5600	82	
Br		3362-LBN-D19	3363-LBN-D19										
AS		3360BND19AS-D	3361BND19AS-D	AS	61W	9100	220-240V [500mA]	4000	>90	68W	4730	70	
Br		3360BND19AS-D	3361BND19AS-D										
<p>L 2810 mm = solo apparecchio - only fixture L 2815 mm = apparecchio + testate - fixture + caps</p>		ON-OFF	3360-LBC-D28	3361-LBC-D28	SIM	87W	12475	220-240V [500mA]	3000	>90	94W	7675	82
		Br	3360-LBC-D28	3361-LBC-D28									
		AS	3360BCD28-AS	3361BCD28-AS	AS	87W	12475	220-240V [500mA]	3000	>90	94W	6485	69
		Br	3360BCD28-AS	3361BCD28-AS									
	AS	3360LBN-D28	3361LBN-D28	SIM	87W	13000	220-240V [500mA]	4000	>90	94W	8000	85	
	Br	3360LBN-D28	3361LBN-D28										
	AS	3360BND28-AS	3361BND28-AS	AS	87W	13000	220-240V [500mA]	4000	>90	94W	6760	72	
	Br	3360BND28-AS	3361BND28-AS										
		DALI	3362-LBC-D28	3363-LBC-D28	SIM	87W	12475	220-240V [500mA]	3000	>90	94W	7675	82
		Br	3362-LBC-D28	3363-LBC-D28									
		AS	3360BCD28AS-D	3361BCD28AS-D	AS	87W	12475	220-240V [500mA]	3000	>90	94W	6485	69
		Br	3360BCD28AS-D	3361BCD28AS-D									
AS		3362-LBN-D28	3363-LBN-D28	SIM	87W	13000	220-240V [500mA]	4000	>90	94W	8000	85	
Br		3362-LBN-D28	3363-LBN-D28										
AS		3360BND28AS-D	3361BND28AS-D	AS	87W	13000	220-240V [500mA]	4000	>90	94W	6760	72	
Br		3360BND28AS-D	3361BND28AS-D										







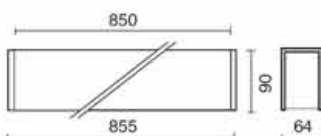

LINEAR SYSTEM

LUCE DIRETTA + INDIRECTA
DIRECT + INDIRECT LIGHT
64 x h. 90 mm
LUCE DIRETTA + INDIRECTA
DIRECT + INDIRECT LIGHT

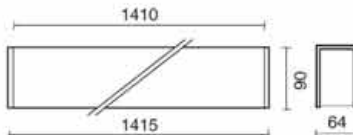
SIMMETRICA
SYMMETRICAL

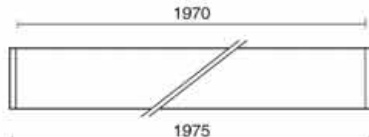
VERSIONE CON 1 STRISCIA LED
VERSION WITH 1 LED STRIP

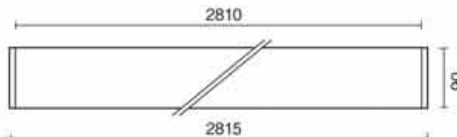







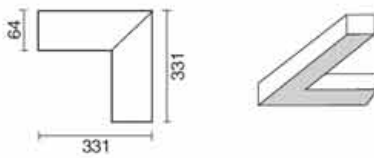

- PARETE - WALL
- SOSPENSIONE - SUSPENSION

			LED					SISTEMA-SYSTEM				
			W	lm	V	K	CRI	W	lm	lm/W		
 <p>L 850 mm = solo apparecchio - only fixture L 855 mm = apparecchio + testate - fixture + caps</p>		ON-OFF Br 3360-LBC-DE9 DIRETTA-DIRECT Ne 3361-LBC-DE9 INDIRETTA-INDIRECT	26W	3743	220-240V	3000	>90	30W	2300	76		
			9W	1248	(500mA)			9W	990	110		
		Br 3360-LBN-DE9 DIRETTA-DIRECT Ne 3361-LBN-DE9 INDIRETTA-INDIRECT	26W	3900	220-240V	4000	>90	30W	2400	80		
			9W	1300	(500mA)			9W	1023	114		
		 DALI DALI Pkg 4,20 Br 3362-LBC-DE9 DIRETTA-DIRECT Ne 3363-LBC-DE9 INDIRETTA-INDIRECT	26W	3743	220-240V	3000	>90	30W	2300	76		
			9W	1248	(500mA)			9W	990	110		
		Br 3362-LBN-DE9 DIRETTA-DIRECT Ne 3363-LBN-DE9 INDIRETTA-INDIRECT	26W	3900	220-240V	4000	>90	30W	2400	80		
			9W	1300	(500mA)			9W	1028	114		
		 <p>L 1410 mm = solo apparecchio - only fixture L 1415 mm = apparecchio + testate - fixture + caps</p>		ON-OFF Br 3360-LBC-DE14 DIRETTA-DIRECT Ne 3361-LBC-DE14 INDIRETTA-INDIRECT	43W	6238	220-240V	3000	>90	47W	3940	82
					17W	2495	(500mA)			17W	1917	113
				Br 3360-LBN-DE14 DIRETTA-DIRECT Ne 3361-LBN-DE14 INDIRETTA-INDIRECT	43W	6500	220-240V	4000	>90	47W	4020	85
					17W	2600	(500mA)			17W	2020	117
 DALI DALI Pkg 6,80 Br 3362-LBC-DE14 DIRETTA-DIRECT Ne 3363-LBC-DE14 INDIRETTA-INDIRECT	43W			6238	220-240V	3000	>90	47W	3940	82		
	17W			2495	(500mA)			17W	1917	113		
Br 3362-LBN-DE14 DIRETTA-DIRECT Ne 3363-LBN-DE14 INDIRETTA-INDIRECT	43W			6500	220-240V	4000	>90	47W	4000	85		
	17W			2600	(500mA)			17W	2000	117		
 <p>L 1970 mm = solo apparecchio - only fixture L 1975 mm = apparecchio + testate - fixture + caps</p>				ON-OFF Br 3360-LBC-DE19 DIRETTA-DIRECT Ne 3361-LBC-DE19 INDIRETTA-INDIRECT	61W	8733	220-240V	3000	>90	68W	5370	79
					25W	3742	(500mA)			25W	2855	114
				Br 3360-LBN-DE19 DIRETTA-DIRECT Ne 3361-LBN-DE19 INDIRETTA-INDIRECT	61W	9100	220-240V	4000	>90	68W	5600	82
					25W	3940	(500mA)			25W	2910	118
		 DALI DALI Pkg 9,50 Br 3362-LBC-DE19 DIRETTA-DIRECT Ne 3363-LBC-DE19 INDIRETTA-INDIRECT	61W	8733	220-240V	3000	>90	68W	5370	79		
			25W	3742	(500mA)			25W	2855	114		
		Br 3362-LBN-DE19 DIRETTA-DIRECT Ne 3363-LBN-DE19 INDIRETTA-INDIRECT	61W	9100	220-240V	4000	>90	68W	5600	82		
			25W	3940	(500mA)			25W	2970	118		
		 <p>L 2810 mm = solo apparecchio - only fixture L 2815 mm = apparecchio + testate - fixture + caps</p>		ON-OFF Br 3360-LBC-DE28 DIRETTA-DIRECT Ne 3361-LBC-DE28 INDIRETTA-INDIRECT	87W	12475	220-240V	3000	>90	94W	7675	82
					34W	4990	(500mA)			34W	3838	113
				Br 3360-LBN-DE28 DIRETTA-DIRECT Ne 3361-LBN-DE28 INDIRETTA-INDIRECT	87W	13000	220-240V	4000	>90	94W	8650	85
					34W	5200	(500mA)			34W	3997	118
 DALI DALI Pkg 13,6 Br 3362-LBC-DE28 DIRETTA-DIRECT Ne 3363-LBC-DE28 INDIRETTA-INDIRECT	87W			12475	220-240V	3000	>90	94W	7675	82		
	34W			4990	(500mA)			34W	3838	113		
Br 3362-LBN-DE28 DIRETTA-DIRECT Ne 3363-LBN-DE28 INDIRETTA-INDIRECT	87W			13000	220-240V	4000	>90	94W	8000	85		
	34W			5200	(500mA)			34W	3997	118		

LINEAR SYSTEM

ACCESSORI - ACCESSORIES

64 x h. 90 mm

			LED					SISTEMA-SYSTEM			
			W	lm	V	K	CRI	W	lm	⊕	
MODULO ANGOLARE A INCASSO/PLAFONE RECESSED/CEILING ANGLE MODULE 	ON-OFF										
	Br 3364-LBC-A	17W	2496	220-240V [500mA]	3000	>80	20W	1595	80		
	Ne 3365-LBC-A										
	Br 3364-LBN-A	17W	2600	220-240V [500mA]	4000	>80	20W	1661	83		
	Ne 3365-LBN-A										
	DALI										
	Br 3364LBCA-DA	17W	2496	220-240V [500mA]	3000	>80	20W	1595	80		
	Ne 3365LBCA-DA										
	Br 3364LBNA-DA	17W	2600	220-240V [500mA]	4000	>80	20W	1661	83		
	Ne 3365LBNA-DA										
MODULO ANGOLARE A PARETE/PLAFONE WALL/CEILING ANGLE MODULE 	ON-OFF										
	Br 3364-LBC-AM	17W	2496	220-240V [500mA]	3000	>80	20W	1595	80		
	Ne 3365-LBC-AM										
	Br 3364-LBN-AM	17W	2600	220-240V [500mA]	4000	>80	20W	1661	83		
	Ne 3365-LBN-AM										
	DALI										
	Br 3364LBCAM-DA	17W	2496	220-240V [500mA]	3000	>80	20W	1595	80		
	Ne 3365LBCAM-DA										
	Br 3364LBNAM-DA	17W	2600	220-240V [500mA]	4000	>80	20W	1661	83		
	Ne 3365LBNAM-DA										
KIT FISSAGGIO A INCASSO (CARTONGESSO $\Delta = \pm 10$ mm) RECESSED FIXING KIT (PLASTERBOARD $\Delta = \pm 10$ mm) 											980016-I-64
KIT FISSAGGIO A PARETE WALL FIXING KIT 											980017-P-64
KIT SOSPENSIONE A FILO - Ø 1,2 mm - LUNGH. 3 m WIRE SUSPENSION KIT - Ø 1,2 mm - LENGTH 3 m 											980012-S-64
KIT DI GIUNZIONE ELETTROMECCANICA ELECTROMECHANICAL JUNCTION KIT 											980019
KIT BLOCCACAVO SOSPENSIONE (ROSONE) CABLE LOCK KIT SUSPENSION (CANOPY) 											Br 699907 Ne 980052
KIT N. 2 TESTATE DI CHIUSURA IN ALLUMINIO SENZA VITI A VISTA KIT N. 2 END CAPS ALUMINIUM PAINTED NO VISIBLE SCREWS 											Br 98001306-T-64 Ne 98001307-T-64

OP. A richiesta - On request: Schermo policarbonato opale - Opal polycarbonate screen



ALIMENTATORI-KIT RGB (se non in dotazione) da ordinare dalla sezione arancio - DRIVERS-RGB KITS (when not supplied) to be ordered from the section orange color



LINEAR SYSTEM



- Struttura in estruso di alluminio verniciato.
- Testata chiusura in alluminio verniciato, senza viti a vista.
- Verniciatura in polveri di poliestere.
- Schermo in policarbonato opale.
- Led durata utile: 50.000 (h) L80 B20.
- Schermo microprismatizzato in metacrilato.

- Extruded aluminium painted structure.
- End cap in aluminium painted, no visible screws.
- Polyester powder coating.
- Opale polycarbonate diffuser.
- Led life: 50.000 (h) L80 B20.
- Microprismatic methacrylate screen.

LUCE DIRETTA DIRECT LIGHT





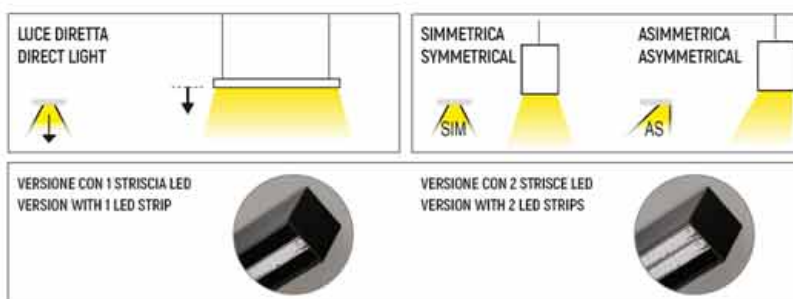

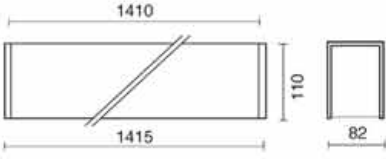

82 x h. 110 mm

- INCASSO - RECESSED
- PARETE - WALL
- PLAFONE - CEILING
- SOSPENSIONE - SUSPENSION

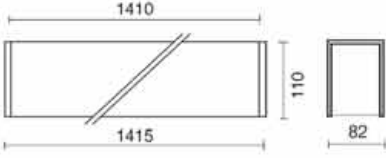

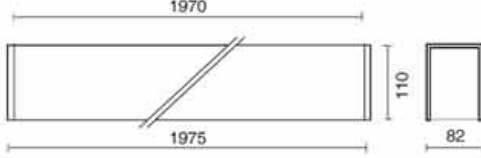
	LED	SISTEMA-SYSTEM						
		W	lm	V	K	CRI		
VERSIONE CON 1 STRISCIA LED VERSION WITH 1 LED STRIP								
<p>L 850 mm = solo apparecchio - only fixture L 855 mm = apparecchio + testate - fixture + caps</p>	ON-OFF							
	Br 3380-LBC-D9	26W	3745	220-240V (500mA)	3000	>90	30W 2300 76	
	Ne 3381-LBC-D9							
	Br 3380BCD9-AS	26W	3745	220-240V (500mA)	3000	>90	30W 1945 65	
	Ne 3381BCD9-AS							
	Br 3380-LBN-D9	26W	3900	220-240V (500mA)	4000	>90	30W 2400 80	
	Ne 3381-LBN-D9							
	Br 3380BND9-AS	26W	3900	220-240V (500mA)	4000	>90	30W 1945 68	
	Ne 3381BND9-AS							
		ON-OFF						
		Br 3382-LBC-D9	26W	3745	220-240V (500mA)	3000	>90	30W 2300 76
		Ne 3383-LBC-D9						
Br 3380BCD9AS-D		26W	3745	220-240V (500mA)	3000	>90	30W 1945 65	
Ne 3381BCD9AS-D								
Br 3382-LBN-D9		26W	3900	220-240V (500mA)	4000	>90	30W 2400 80	
Ne 3383-LBN-D9								
Br 3380BND9AS-D		26W	3900	220-240V (500mA)	4000	>90	30W 2030 68	
Ne 3381BND9AS-D								
VERSIONE CON 2 STRISCIE LED VERSION WITH 2 STRIPS								
<p>L 850 mm = solo apparecchio - only fixture L 855 mm = apparecchio + testate - fixture + caps</p>		ON-OFF						
		Br 3380-LBC-D9B	52W	7485	220-240V (500mA)	3000	>90	59W 4605 78
	Ne 3381-LBC-D9B							
	Br 3380-LBN-D9B	52W	7800	220-240V (500mA)	4000	>90	59W 4800 81	
	Ne 3381-LBN-D9B							
		ON-OFF						
		Br 3380BCD9B-DA	52W	7485	220-240V (500mA)	3000	>90	59W 4605 78
		Ne 3381BCD9B-DA						
		Br 3380BND9B-DA	52W	7800	220-240V (500mA)	4000	>90	59W 4800 81
		Ne 3381BND9B-DA						

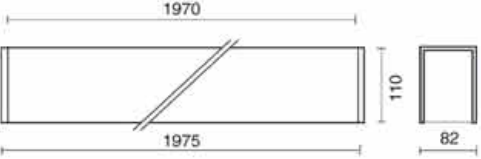
LINEAR SYSTEM

	ON-OFF	Br	Ne	Icon	LED					SISTEMA-SYSTEM			
					W	lm	V	K	CRI	W	lm	lm/W	
VERSIONE CON 1 STRISCIA LED VERSION WITH 1 LED STRIP  <p>L 1410 mm = solo apparecchio - only fixture L 1415 mm = apparecchio + testate - fixture + caps</p>	ON-OFF												
	Br	3380-LBC-D14		SIM	43W	6238	220-240V (500mA)	3000	>90	47W	3840	82	
	Ne	3381-LBC-D14											
	Br	3380BCD14-AS		AS	43W	6238	220-240V (500mA)	3000	>90	47W	3240	69	
	Ne	3381BCD14-AS											
	Br	3380-LBN-D14		SIM	43W	6500	220-240V (500mA)	4000	>90	47W	4000	85	
	Ne	3381-LBN-D14											
	Br	3380BND14-AS		AS	43W	6500	220-240V (500mA)	4000	>90	47W	3380	72	
	Ne	3381BND14-AS											
		ON-OFF											
		Br	3382-LBC-D14		SIM	43W	6238	220-240V (500mA)	3000	>90	47W	3840	82
		Ne	3383-LBC-D14										
Br		3380BCD14AS-D		AS	43W	6238	220-240V (500mA)	3000	>90	47W	3240	69	
Ne		3381BCD14AS-D											
Br		3382-LBN-D14		SIM	43W	6500	220-240V (500mA)	4000	>90	47W	4000	85	
Ne	3383-LBN-D14												
Br	3380BND14AS-D		AS	43W	6500	220-240V (500mA)	4000	>90	47W	3380	72		
Ne	3381BND14AS-D												
VERSIONE CON 2 STRISCIE LED VERSION WITH 2 STRIPS  <p>L 1410 mm = solo apparecchio - only fixture L 1415 mm = apparecchio + testate - fixture + caps</p>	ON-OFF												
	Br	3380-LBC-D14B			87W	12475	220-240V (500mA)	3000	>90	94W	7677	82	
	Ne	3381-LBC-D14B											
	Br	3380-LBN-D14B			87W	13000	220-240V (500mA)	4000	>90	94W	8000	85	
	Ne	3381-LBN-D14B											
		ON-OFF											
		Br	3380BCD14B-DA		AS	87W	12475	220-240V (500mA)	3000	>90	94W	7677	82
	Ne	3381BCD14B-DA											
	Br	3380BND14B-DA			87W	13000	220-240V (500mA)	4000	>90	94W	8000	85	
	Ne	3381BND14B-DA											
	VERSIONE CON 1 STRISCIA LED VERSION WITH 1 LED STRIP  <p>L 1970 mm = solo apparecchio - only fixture L 1975 mm = apparecchio + testate - fixture + caps</p>	ON-OFF											
		Br	3380-LBC-D19		SIM	61W	8733	220-240V (500mA)	3000	>90	68W	5370	79
Ne		3381-LBC-D19											
Br		3380BCD19-AS		AS	61W	8733	220-240V (500mA)	3000	>90	68W	4540	67	
Ne		3381BCD19-AS											
Br		3380-LBN-D19		SIM	61W	9100	220-240V (500mA)	4000	>90	68W	5600	82	
Ne		3381-LBN-D19											
Br		3380BND19-AS		AS	61W	9100	220-240V (500mA)	4000	>90	68W	4730	70	
Ne		3381BND19-AS											
		ON-OFF											
		Br	3382-LBC-D19		SIM	61W	8733	220-240V (500mA)	3000	>90	68W	5770	79
		Ne	3383-LBC-D19										
	Br	3380BCD19AS-D		AS	61W	8733	220-240V (500mA)	3000	>90	68W	4540	67	
	Ne	3381BCD19AS-D											
	Br	3382-LBN-D19		SIM	61W	9100	220-240V (500mA)	4000	>90	68W	5600	82	
Ne	3383-LBN-D19												
Br	3380BND19AS-D		AS	61W	9100	220-240V (500mA)	4000	>90	68W	4730	70		
Ne	3381BND19AS-D												
VERSIONE CON 2 STRISCIE LED VERSION WITH 2 STRIPS  <p>L 1970 mm = solo apparecchio - only fixture L 1975 mm = apparecchio + testate - fixture + caps</p>	ON-OFF												
	Br	3380-LBC-D19B			121W	17466	220-240V (500mA)	3000	>90	131W	10745	82	
	Ne	3381-LBC-D19B											
	Br	3380-LBN-D19B			121W	18200	220-240V (500mA)	4000	>90	131W	11200	86	
	Ne	3381-LBN-D19B											
		ON-OFF											
		Br	3380BCD19B-DA		AS	121W	17466	220-240V (500mA)	3000	>90	131W	10745	82
	Ne	3381BCD19B-DA											
	Br	3380BND19B-DA			121W	18200	220-240V (500mA)	4000	>90	131W	11200	86	
	Ne	3381BND19B-DA											

LINEAR SYSTEM

LUCE DIRETTA
DIRECT LIGHT**82 x h. 110 mm**

	ON-OFF	Br	Ne	SIM	AS	LED					SISTEMA-SYSTEM								
						W	lm	V	K	CRI	W	lm	W						
VERSIONE CON 1 STRISCIA LED VERSION WITH 1 LED STRIP <p>L 2810 mm = solo apparecchio - only fixture L 2815 mm = apparecchio + testate - fixture + caps</p>																			
	VERSIONE CON 2 STRISCE LED VERSION WITH 2 STRIPS <p>L 2810 mm = solo apparecchio - only fixture L 2815 mm = apparecchio + testate - fixture + caps</p>																		

LINEAR SYSTEM

LUCE DIRETTA + INDIRECTA
DIRECT + INDIRECT LIGHT

82 x h. 110 mm

LUCE DIRETTA + INDIRECTA
DIRECT + INDIRECT LIGHT



SIMMETRICA
SIMMETRICA



VERSIONE CON 1 STRISCIA LED
VERSION WITH 1 LED STRIP









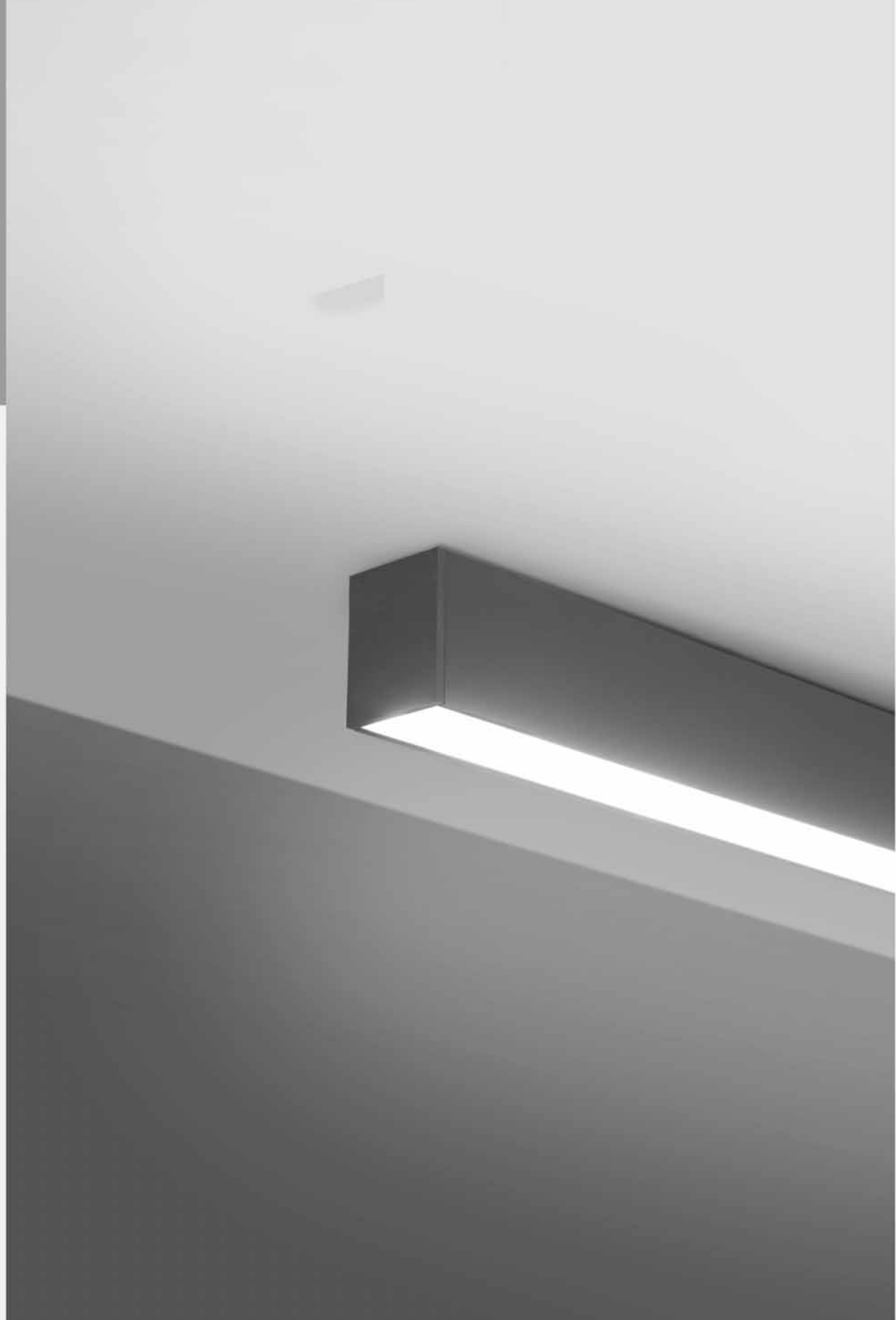

- PARETE - WALL
- SOSPENSIONE - SUSPENSION

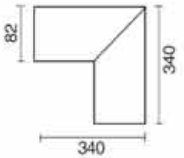
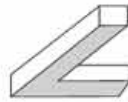
	ON-OFF	Br	Ne	DIRETTA-DIRECT	INDIRETTA-INDIRECT	LED					SISTEMA-SYSTEM		
						W	lm	V	K	CR	W	lm	lm/W
 L 850 mm = solo apparecchio - only fixture L 855 mm = apparecchio + testate - fixture + caps	 DALI 4,20	3380-LBC-DE9	3381-LBC-DE9	DIRETTA-DIRECT	INDIRETTA-INDIRECT	28W	3743	220-240V	3000	>90	30W	2300	76
		Ne	9W	1248	[500mA]	9W	990	110					
	 DALI 4,20	3380-LBN-DE9	3381-LBN-DE9	DIRETTA-DIRECT	INDIRETTA-INDIRECT	28W	3900	220-240V	4000	>90	30W	2400	80
		Ne	9W	1300	[500mA]	9W	1028	114					
	 DALI 4,20	3382-LBC-DE9	3383-LBC-DE9	DIRETTA-DIRECT	INDIRETTA-INDIRECT	28W	3743	220-240V	3000	>90	30W	2300	76
		Ne	9W	1300	[500mA]	9W	990	110					
 DALI 4,20	3382-LBN-DE9	3383-LBN-DE9	DIRETTA-DIRECT	INDIRETTA-INDIRECT	28W	3900	220-240V	4000	>90	30W	2400	80	
	Ne	9W	1300	[500mA]	9W	1028	114						
 L 1410 mm = solo apparecchio - only fixture L 1415 mm = apparecchio + testate - fixture + caps	 DALI 6,80	3380-LBC-DE14	3381-LBC-DE14	DIRETTA-DIRECT	INDIRETTA-INDIRECT	43W	6238	220-240V	3000	>90	47W	3840	82
		Ne	17W	2495	[500mA]	17W	1917	113					
	 DALI 6,80	3380-LBN-DE14	3381-LBN-DE14	DIRETTA-DIRECT	INDIRETTA-INDIRECT	43W	6500	220-240V	4000	>90	47W	4000	85
		Ne	17W	2600	[500mA]	17W	2000	117					
	 DALI 6,80	3382-LBC-DE14	3383-LBC-DE14	DIRETTA-DIRECT	INDIRETTA-INDIRECT	43W	6238	220-240V	3000	>90	47W	3846	82
		Ne	17W	2495	[500mA]	17W	1917	113					
 DALI 6,80	3382-LBN-DE14	3383-LBN-DE14	DIRETTA-DIRECT	INDIRETTA-INDIRECT	43W	6500	220-240V	4000	>90	47W	4000	85	
	Ne	17W	2600	[500mA]	17W	2000	117						
 L 1970 mm = solo apparecchio - only fixture L 1975 mm = apparecchio + testate - fixture + caps	 DALI 9,50	3380-LBC-DE19	3381-LBC-DE19	DIRETTA-DIRECT	INDIRETTA-INDIRECT	61W	8733	220-240V	3000	>90	68W	5370	79
		Ne	25W	3742	[500mA]	25W	2855	114					
	 DALI 9,50	3380-LBN-DE19	3381-LBN-DE19	DIRETTA-DIRECT	INDIRETTA-INDIRECT	61W	9100	220-240V	4000	>90	68W	5600	82
		Ne	25W	3940	[500mA]	25W	2970	118					
	 DALI 9,50	3382-LBC-DE19	3381-LBC-DE19	DIRETTA-DIRECT	INDIRETTA-INDIRECT	61W	8733	220-240V	3000	>90	68W	5370	79
		Ne	25W	3742	[500mA]	25W	2855	114					
 DALI 9,50	3382-LBN-DE19	3381-LBN-DE19	DIRETTA-DIRECT	INDIRETTA-INDIRECT	61W	9100	220-240V	4000	>90	68W	5600	82	
	Ne	25W	3940	[500mA]	25W	2970	118						
 L 2810 mm = solo apparecchio - only fixture L 2815 mm = apparecchio + testate - fixture + caps	 DALI 13,6	3380-LBC-DE28	3381-LBC-DE28	DIRETTA-DIRECT	INDIRETTA-INDIRECT	87W	12475	220-240V	3000	>90	94W	7675	82
		Ne	34W	4990	[500mA]	34W	3838	113					
	 DALI 13,6	3380-LBN-DE28	3381-LBN-DE28	DIRETTA-DIRECT	INDIRETTA-INDIRECT	87W	13000	220-240V	4000	>90	94W	8000	82
		Ne	34W	5800	[500mA]	34W	3997	118					
	 DALI 13,6	3382-LBC-DE28	3383-LBC-DE28	DIRETTA-DIRECT	INDIRETTA-INDIRECT	87W	12475	220-240V	3000	>90	94W	7675	82
		Ne	34W	4990	[500mA]	34W	3838	113					
 DALI 13,6	3382-LBN-DE28	3383-LBN-DE28	DIRETTA-DIRECT	INDIRETTA-INDIRECT	87W	13000	220-240V	4000	>90	94W	8000	85	
	Ne	34W	5800	[500mA]	34W	3997	118						

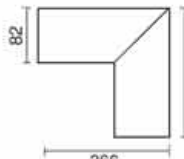
ALIMENTATORI-KIT RGB (se non in dotazione) da ordinare dalla sezione arancio - DRIVERS-RGB KITS (when not supplied) to be ordered from the section orange color



LINEAR SYSTEM

	LED					SISTEMA-SYSTEM				
	W	lm	V	K	CRI	W	lm	lm/W		
MODULO ANGOLARE A INCASSO/PLAFONE RECESSED/CEILING ANGLE MODULE  	ON-OFF									
	Br	3384-LBC-A	17W	2495	24V [500mA]	3000	>90	20W	1595	80
	Ne	3385-LBC-A								
	Br	3384-LBN-A	17W	2495	24V [500mA]	4000	>90	20W	1595	80
	Ne	3385-LBN-A								
 DALI  DALI Br 3384LBCA-DA Ne 3385LBCA-DA Br 3384LBNA-DA Ne 3385LBNA-DA	Br	3384LBCA-DA	17W	2495	24V [500mA]	3000	>90	20W	1595	80
	Ne	3385LBCA-DA								
	Br	3384LBNA-DA	17W	2495	24V [500mA]	4000	>90	20W	1595	80
	Ne	3385LBNA-DA								
	MODULO ANGOLARE A PARETE/PLAFONE WALL/CEILING ANGLE MODULE  	ON-OFF								
Br		3384-LBC-AM	17W	2600	24V [500mA]	3000	>90	20W	1661	83
Ne		3385-LBC-AM								
Br		3384-LBN-AM	17W	2600	24V [500mA]	4000	>90	20W	1661	83
Ne		3385-LBN-AM								
 DALI DIM-DALI Br 3384LBCAM-DA Ne 3385LBCAM-DA Br 3384LBNAM-DA Ne 3385LBNAM-DA	Br	3384LBCAM-DA	17W	2600	24V [500mA]	3000	>90	20W	1661	83
	Ne	3385LBCAM-DA								
	Br	3384LBNAM-DA	17W	2600	24V [500mA]	4000	>90	20W	1661	83
	Ne	3385LBNAM-DA								
	KIT FISSAGGIO A PARETE WALL FIXING KIT		980017-P-82							
KIT SOSPENSIONE A FILO - Ø 1,2 mm - LUNGH. 3 m WIRE SUSPENSION KIT - Ø 1,2 mm - LENGTH 3 m		980012-S-82								
KIT DI GIUNZIONE ELETTROMECCANICA ELECTROMECHANICAL JUNCTION KIT		980019								
KIT SOSPENSIONE (ROSONE) KIT SUSPENSION (CANOPY)		Br 699907 Ne 980052								
KIT N. 2 TESTATE DI CHIUSURA IN ALLUMINIO, SENZA VITI A VISTA KIT N. 2 END CAPS ALUMINIUM PAINTED, NO VISIBLE SCREWS		Br 98001306-T-82 Ne 98001307-T-82								

OP. A richiesta - On request: Schermo policarbonato opale - Opal polycarbonate screen





ENTRATA

SABATO E DOMENICA
Bastardi
APERTO.
Vi aspettiamo

SABATO E DOMENICA
Bastardi
APERTO.
Vi aspettiamo

IL NUOVO VOLANTINO? CE L'HAI GIÀ IN TASCA

1 2 3 SCONTO!
Buoni sconto personalizzati

PIÙ SPENDE, PIÙ OTTIENI.
Salvo 1€ di spesa minima

1 Spendere 1€ nel salotto in fronte coperto (escluso il salotto) e ricevere un buono sconto personalizzato

2 Spendere 2€ nel salotto in fronte coperto (escluso il salotto) e ricevere un buono sconto personalizzato

3 Spendere 3€ nel salotto in fronte coperto (escluso il salotto) e ricevere un buono sconto personalizzato

Regolamenti, condizioni e spiegazione i trovi dall'8 al www.bastardi.com per verificare a quali buoni possono far diritto.



L'ERBOLARIO



LIGHT CUT

Grazie alle minimali dimensioni delle sorgenti permette di unire elementi strutturali e luminosi in ogni contesto architettonico con grande efficacia e facilità.

Sorgenti luminose lineari flessibili e sempre più efficienti si uniscono a profili di ogni forma e misura, che si alloggiavano con facilità nelle superfici di rivestimento e copertura.

Il risultato sono linee luminose di grande effetto che fendono lo spazio, creando disegni, contrasti e accenti.

Svariate forme e misure contraddistinte da un comune denominatore: qualità dei componenti, flessibilità e facilità di impiego.

Thanks to the minimal dimensions of the sources, it allows to combine structural and luminous elements in any architectural context with great effectiveness.

Flexible and increasingly efficient linear light sources are combined with WITH TRIMS of all shapes and sizes, which fit easily into the cladding and roofing surfaces.

The result is bright lines of great effect that cut the space, creating designs, contrasts and accents.

Various shapes and sizes characterized by a common denominator: quality of components, flexibility and ease of use.

INDICE PROFILI - PROFIL INDEX

LIGHT CUT 20

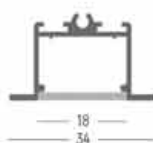

LIGHT CUT 30

BATTUTA
WITH TRIM

SENZA CORNICE
TRIMLESS

ANGOLARE SENZA CORNICE
TRIMLESS ANGULAR PROFILE

ANGOLARE LUCE RETROCESSA
RECESSED ANGULAR

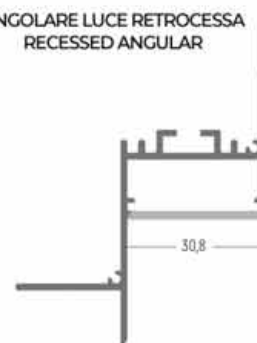
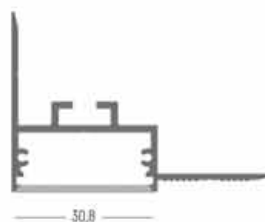
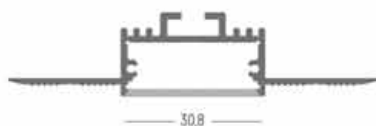
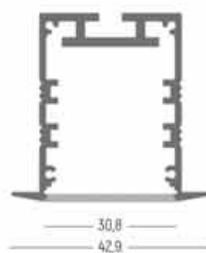

LIGHT CUT 55

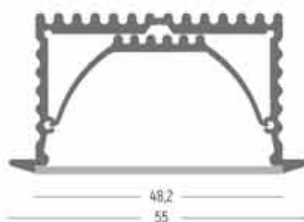

LIGHT CUT 75

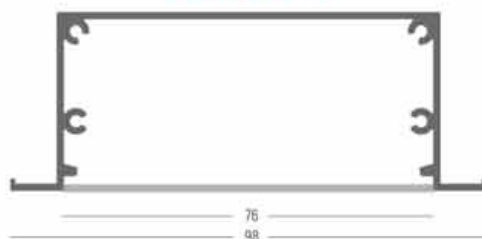

LIGHT CUT 20



IP 20
IP 40



ALIMENTATORI-KIT RGB (se non in dotazione) da ordinare dalla sezione arancio - DRIVERS-RGB KITS (when not supplied) to be ordered from the section orange color



LIGHT CUT 20

- Corpo estruso in alluminio verniciato.
- Testate in alluminio verniciato.
- Schermo in policarbonato opale.
- Molle in acciaio temperato.
- Strip Led 24V - 22W/m - CRI >90

- Extruded aluminum body painted.
- Aluminum heads painted.
- Polycarbonate opal screen.
- Tempered steel springs.
- Strip Led 24V - 14,4W/m - CRI >90



22 x (L) + 4 mm $\Delta = 1+20$ mm

SISTEMA FINITO - FINISHED SYSTEM					LUNGHEZZA mm LENGTH mm	W	LED (lm)	V	K	CRI
				620-100-LBC-OP	1010	14,4W	1600	24V	3000	>90
				620-100-LBN-OP			1650		4000	
	620-200-LBC-OP	2010	28,8W	3200	24V	3000	>90			
				620-200-LBN-OP			3300		4000	
				620-300-LBC-OP	3010	43,2W	4800	24V	3000	>90
				620-300-LBN-OP			4950		4000	
MODULO ANGOLARE - ANGULAR MODULE					130 x 130	2,9W	320	24V	3000	>90
					620-9090-LBC-OP		330		4000	
					620-9090-LBN-OP					

PRODOTTO COMPONIBILE - MODULAR SYSTEM										
KIT ESTRUSO ALLUMINIO - ALUMINUM EXTRUDED KIT					980085	2 mt	VERNICIATO BIANCO - WHITE PAINTED			
					980086	3 mt	VERNICIATO BIANCO - WHITE PAINTED			
KIT SCHERMO PIANO - FLAT SCREEN KIT					980087	2 mt	POLICARBONATO OPALE - OPAL POLYCARBONATE			
					980088	3 mt	POLICARBONATO OPALE - OPAL POLYCARBONATE			
KIT TESTATE DI CHIUSURA - CLOSING HEADS KIT					6011	n. 2 Pezzi - Pieces	TESTATE VERNICIATE BIANCO - WHITE PAINTED HEADS			
KIT MOLLE PER ANCORAGGIO - SPRING KIT FOR ANCHORING					980117	n. 4 Pezzi - Pieces				

STRIP LED FLEX					L (m)	TAGLIO (mm) CUT (mm)	W (m)	lm (m)	V	K	CRI
	646165-LBC				5	50	14,4W	1600	24Vdc	3000	>90
	646165-LBN						1650		4000		

DRIVER CONSIGLIATI - RECOMMENDED DRIVERS

645038	ON-OFF	60W	IP20	24Vdc	
645216	ON-OFF	100W	IP67	24Vdc	
645179	ON-OFF	150W	IP20	24Vdc	
646371	ON-OFF	250W	IP67	24Vdc	
645687	DIM-DALI	50W	IP20	24Vdc	1-4 canali
645686	DIM-DALI	80W	IP20	24Vdc	1-4 canali

OP: A richiesta - On request; disponibile - available



LIGHT CUT 30



DRIVER CONSIGLIATI - RECOMMENDED DRIVERS

645038	ON-OFF	60W	IP20	24Vdc	
645216	ON-OFF	100W	IP67	24Vdc	
645179	ON-OFF	150W	IP20	24Vdc	
646371	ON-OFF	250W	IP67	24Vdc	
645687	DIM-DALI	50W	IP20	24Vdc	1-4 canali
645686	DIM-DALI	80W	IP20	24Vdc	1-4 canali

DE. A richiesta - On request, disponibile - available



IP 20
IP 40



LIGHT CUT 30



- Corpo estruso in alluminio verniciato.
- Testate in alluminio verniciato.
- Schermo in policarbonato opale.
- Molle in acciaio temperato.
- Driver escluso.
- Strip Led 24V - 22W/m - CRI >80

- Extruded aluminum body painted.
- Aluminum heads painted.
- Polycarbonate opal screen.
- Tempered steel springs.
- Driver not included.
- Strip Led 24V - 22W/m - CRI >80

BATTUTA - WITH TRIM

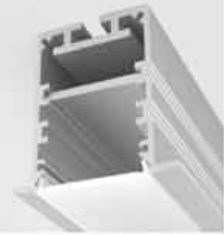

SISTEMA FINITO - FINISHED SYSTEM

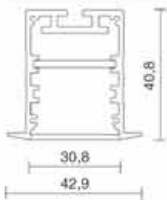

	Kg	Br	LUNGHEZZA mm LENGTH mm	LED					
				W	lm	V	K	CRI	
	1,13	Br	630-100-LBC-OP 630-100-LBN-OP	1010	22W	3000 3100	24V	3000 4000	>80
	2,20	Br	630-200-LBC-OP 630-200-LBN-OP	2010	44W	6000 6200	24V	3000 4000	>80
	3,27	Br	630-300-LBC-OP 630-300-LBN-OP	3010	66W	9000 9300	24V	3000 4000	>80

MODULO ANGOLARE - ANGULAR MODULE

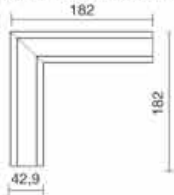

	0,45	Br	630-9090-LBC-OP 630-9090-LBN-OP	182 x 182	6,6W	900 930	24V	3000 4000	>80
--	------	----	------------------------------------	-----------	------	------------	-----	--------------	-----

SISTEMA COMPONENTE - MODULAR SYSTEM

KIT ESTRUSO ALLUMINIO - ALUMINUM EXTRUDED KIT



	1,50	Br	980089	2 mt	VERNICIATO BIANCO - WHITE PAINTED
	2,25	Br	980090	3 mt	VERNICIATO BIANCO - WHITE PAINTED

KIT DISSIPATORE ESTRUSO ALLUMINIO
ALUMINUM EXTRUDED SINK KIT

	0,27	Br	980105	2 mt	
	0,40	Br	980106	3 mt	

KIT SCHERMO PIANO - FLAT SCREEN KIT



	0,18		980101	2 mt	POLICARBONATO TRASPARENTE PRISMATICO - TRANSPARENT PRISMATIC POLYCARBONATE
	0,27		980102	3 mt	POLICARBONATO TRASPARENTE PRISMATICO - TRANSPARENT PRISMATIC POLYCARBONATE
	0,18		980103	2 mt	POLICARBONATO OPALE - OPAL POLYCARBONATE
	0,27		980104	3 mt	POLICARBONATO OPALE - OPAL POLYCARBONATE

KIT TESTATE DI CHIUSURA - CLOSING HEADS KIT



		Br	980074	n.2 Pezzi - Pieces	VERNICIATO BIANCO - WHITE PAINTED
--	--	----	--------	--------------------	-----------------------------------

KIT MOLLE PER ANCORAGGIO - SPRING KIT FOR ANCHORING



			980073	n.1 Pezzo - Piece	
--	--	--	--------	-------------------	--

CONGIUNZIONI - CONJUNCTIONS



			980075	CONGIUNZIONE LINEARE - LINEAR CONJUNCTION
			980076	CONGIUNZIONE ANGOLARE - ANGULAR CONJUNCTION
			980078	CONGIUNZIONE ANGOLARE - ANGULAR CONJUNCTION

STRIP LED FLEX



	Kg	Br	L [m]	TAGLIO (mm) CUT (mm)	LED				
					W [m]	lm [m]	V	K	CRI
			5	50	22W	3000 3100	24Vdc	3000 4000	>80
			646195-LBC 646195-LBN						



LIGHT CUT 30SC

- Corpo estruso in alluminio verniciato.
- Testate in alluminio verniciato.
- Schermo in policarbonato opale.
- Driver escluso.
- Strip Led 24V - 22W/m - CRI >80

- Extruded aluminum body painted.
- Aluminum heads painted.
- Polycarbonate opal screen.
- Driver not included.
- Strip Led 24V - 22W/m - CRI >80

SENZA CORNICE - TRIMLESS

32 x (L) + 4 mm Δ 0+20 mm

SISTEMA FINITO - FINISHED SYSTEM

			LUNGHEZZA mm LENGTH mm	(W) LED	(lm)	(V)	(K)	(CRI)
		Br	631-100-LBC-OP	22W	3000	24V	3000	>80
			631-100-LBN-OP		3100		4000	
		Br	631-200-LBC-OP	44W	6000	24V	3000	>80
			631-200-LBN-OP		6200		4000	
		Br	631-300-LBC-OP	66W	9000	24V	3000	>80
			631-300-LBN-OP		9300		4000	

MODULO ANGOLARE - ANGULAR MODULE

			LUNGHEZZA mm LENGTH mm	(W) LED	(lm)	(V)	(K)	(CRI)
		Br	631-9090-LBC-OP	6,6W	900	24V	3000	>80
			631-9090-LBN-OP		930		4000	

SISTEMA COMPONENTE - MODULAR SYSTEM

KIT ESTRUSO ALLUMINIO - ALUMINUM EXTRUDED KIT

		Br	980091	2 mt	VERNICIATO BIANCO - WHITE PAINTED
		Br	980093	3 mt	VERNICIATO BIANCO - WHITE PAINTED

SCHERMO PIANO - SCHERMO PIANO

		980101	2 mt	POLICARBONATO TRASPARENTE PRISMATICO - TRANSPARENT PRISMATIC POLYCARBONATE
		980102	3 mt	POLICARBONATO TRASPARENTE PRISMATICO - TRANSPARENT PRISMATIC POLYCARBONATE
		980103	2 mt	POLICARBONATO OPALE - OPAL POLYCARBONATE
		980104	3 mt	POLICARBONATO OPALE - OPAL POLYCARBONATE

KIT TESTATE DI CHIUSURA - CLOSING HEADS KIT

	Br	980082	n.3 Pezzi - Pieces	TESTATE VERNICIATE BIANCO - WHITE PAINTED HEADS
--	----	--------	--------------------	---

CONGIUNZIONI - CONJUNCTIONS

	980075	n.1 Pezzo - Piece	CONGIUNZIONE LINEARE - LINEAR CONJUNCTION
	980076	n.1 Pezzo - Piece	CONGIUNZIONE ANGOLARE - ANGULAR CONJUNCTION
	980078	n.1 Pezzo - Piece	CONGIUNZIONE ANGOLARE - ANGULAR CONJUNCTION

STRIP LED FLEX

			L [m]	TAGLIO (mm) CUT (mm)	(W) [m]	(lm) [m]	(V)	(K)	(CRI)
		120	646195-LBC	5	22W	3000	24Vdc	3000	>80
			646195-LBN			3100		4000	



- Corpo estruso in alluminio verniciato.
- Testate in alluminio verniciato.
- Schermo in policarbonato opale.
- Driver escluso.
- Strip Led 24V - 22W/m - CRI >80

- Extruded aluminum body painted.
- Aluminum heads painted.
- Polycarbonate opal screen.
- Driver not included.
- Strip Led 24V - 22W/m - CRI >80

ANGOLARE SENZA CORNICE
TRIMLESS ANGULAR PROFILE

32 x (L) + 6 mm Δ = 0±20 mm

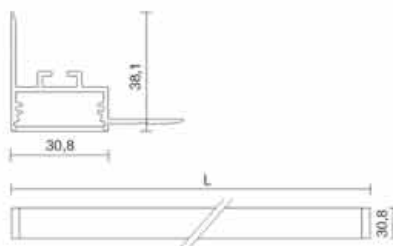
SISTEMA FINITO - FINISHED SYSTEM

			LUNGHEZZA mm LENGTH mm	(W)	LED (lm)	(V)	(K)	(CRI)	
 0,745 Kg Br			632-100-LBC-OP	1010	22W	24V	3000	>80	
			632-100-LBN-OP						
 1,42 Kg Br			632-200-LBC-OP	2010	44W	24V	3000	>80	
			632-200-LBN-OP						
 2,112 Kg Br			632-300-LBC-OP	3010	66W	24V	3000	>80	
			632-300-LBN-OP						
MODULO ANGOLARE - ANGULAR MODULE	 0,29 Kg Br		632-9090-LBC-OP 632-9090-LBN-OP	175 x 175	6,6W	24V	900 930	3000 4000	>80

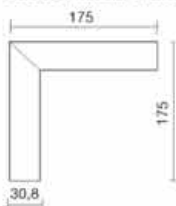
MODULO ANGOLARE - ANGULAR MODULE

SISTEMA COMPONENTE - MODULAR SYSTEM
KIT ESTRUSO ALLUMINIO - ALUMINUM EXTRUDED KIT

 0,98 Kg Br			980097	2 mt VERNICIATO BIANCO - WHITE PAINTED
 1,48 Kg Br			980099	3 mt VERNICIATO BIANCO - WHITE PAINTED

KIT SCHERMO PIANO - FLAT SCREEN KIT

 0,18 Kg	980101	2 mt	POLICARBONATO TRASPARENTE PRISMATICO - TRANSPARENT PRISMATIC POLYCARBONATE
 0,27 Kg	980102	3 mt	POLICARBONATO TRASPARENTE PRISMATICO - TRANSPARENT PRISMATIC POLYCARBONATE
 0,18 Kg	980103	2 mt	POLICARBONATO OPALE - OPAL POLYCARBONATE
 0,27 Kg	980104	3 mt	POLICARBONATO OPALE - OPAL POLYCARBONATE

KIT TESTATE DI CHIUSURA - CLOSING HEADS KIT

Br	980077	n.3 Pezzi - Pieces	TESTATE VERNICIATE BIANCO - WHITE PAINTED HEADS
----	--------	--------------------	---

CONGIUNZIONI - CONJUNCTIONS

980075	n.1 Pezzo - Piece	CONGIUNZIONE LINEARE - LINEAR CONJUNCTION
980076	n.1 Pezzo - Piece	CONGIUNZIONE ANGOLARE - ANGULAR CONJUNCTION
980078	n.1 Pezzo - Piece	CONGIUNZIONE ANGOLARE - ANGULAR CONJUNCTION

STRIP LED FLEX

		L (m)	TAGLIO (mm) CUT (mm)	(W)	(lm)	(V)	(K)	(CRI)
646195-LBC		5	50	22W	3000	24Vdc	3000	>80
646195-LBN								

DRIVER CONSIGLIATI E DATI TECNICI A PAG 328 - RECOMMENDED DRIVERS AND TECHNICAL DATA ON PAGE 328

ALIMENTATORI-KIT RGB (se non in dotazione) da ordinare dalla sezione arancio - DRIVERS-RGB KITS (when not supplied) to be ordered from the section orange color



LIGHT CUT 30AR



- Corpo estruso in alluminio verniciato.
- Testate in alluminio verniciato.
- Schermo in policarbonato opale.
- Molle in acciaio temperato.
- Driver escluso.
- Strip Led 24V - 22W/m - CRI >80
- Extruded aluminum body painted.
- Aluminum heads painted.
- Polycarbonate opal screen.
- Tempered steel springs.
- Driver not included.
- Strip Led 24V - 22W/m - CRI >80

ANGOLARE LUCE RETROCESSA
RECESSED ANGULAR

SISTEMA FINITO - FINISHED SYSTEM

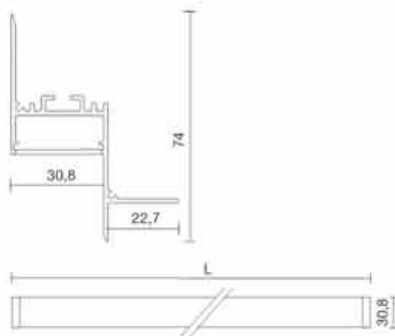

				LUNGHEZZA mm LENGTH mm	(W)	LED (lm)	(V)	(K)	(CRI)
 0,96 Kg Br				633-100-LBC-OP	22W	3000	24V	3000	>80
				633-100-LBN-OP		3100		4000	
 1,86 Kg Br				633-200-LBC-OP	44W	6000	24V	3000	>80
				633-200-LBN-OP		6200		4000	
 2,77 Kg Br				633-300-LBC-OP	66W	9000	24V	3000	>80
				633-300-LBN-OP		9300		4000	

MODULO ANGOLARE - ANGULAR MODULE

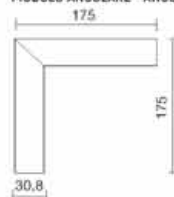

				LUNGHEZZA mm LENGTH mm	(W)	LED (lm)	(V)	(K)	(CRI)
 0,365 Kg Br				633-9090-LBC-OP	6,6W	900	24V	3000	>80
				633-9090-LBN-OP		930		4000	

SISTEMA COMPONENTE - MODULAR SYSTEM

KIT ESTRUSO ALLUMINIO - ALUMINUM EXTRUDED KIT

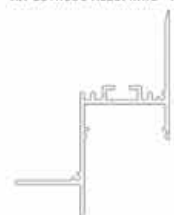

				LUNGHEZZA mm LENGTH mm	DESCRIZIONE
 1,42 Kg Br				980095	2 mt. VERNICIATO BIANCO - WHITE PAINTED
				980096	3 mt. VERNICIATO BIANCO - WHITE PAINTED

KIT SCHERMO PIANO - FLAT SCREEN KIT



				LUNGHEZZA mm LENGTH mm	DESCRIZIONE
 0,18 Kg Br				980101	2 mt. POLICARBONATO TRASPARENTE PRISMATICO - TRANSPARENT PRISMATIC POLYCARBONATE
				980102	3 mt. POLICARBONATO TRASPARENTE PRISMATICO - TRANSPARENT PRISMATIC POLYCARBONATE
 0,27 Kg Br				980103	2 mt. POLICARBONATO OPALE - OPAL POLYCARBONATE
				980104	3 mt. POLICARBONATO OPALE - OPAL POLYCARBONATE

KIT TESTATE DI CHIUSURA - CLOSING HEADS KIT

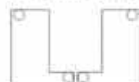

				LUNGHEZZA mm LENGTH mm	DESCRIZIONE
Br				980085	n.2 Pezzi - Pieces TESTATE VERNICIATE BIANCO - VERNICIATE BIANCO

CONGIUNZIONI - CONJUNCTIONS



				LUNGHEZZA mm LENGTH mm	DESCRIZIONE
				980075	n.1 Pezzo - Piece CONGIUNZIONE LINEARE - LINEAR CONJUNCTION
				980076	n.1 Pezzo - Piece CONGIUNZIONE ANGOLARE - ANGULAR CONJUNCTION
				980078	n.1 Pezzo - Piece CONGIUNZIONE ANGOLARE - ANGULAR CONJUNCTION

STRIP LED FLEX



				L (m)	TAGLIO (mm) CUT (mm)	(W)	(lm)	(V)	(K)	(CRI)
				5	50	22W	3000	24Vdc	3000	>80
							3100		4000	

DRIVER CONSIGLIATI E DATI TECNICI A PAG 328 - RECOMMENDED DRIVERS AND TECHNICAL DATA ON PAGE 328

ALIMENTATORI-KIT RGB (se non in dotazione) da ordinare dalla sezione arancio - DRIVERS-RGB KITS (when not supplied) to be ordered from the section orange color

LIGHT CUT 55

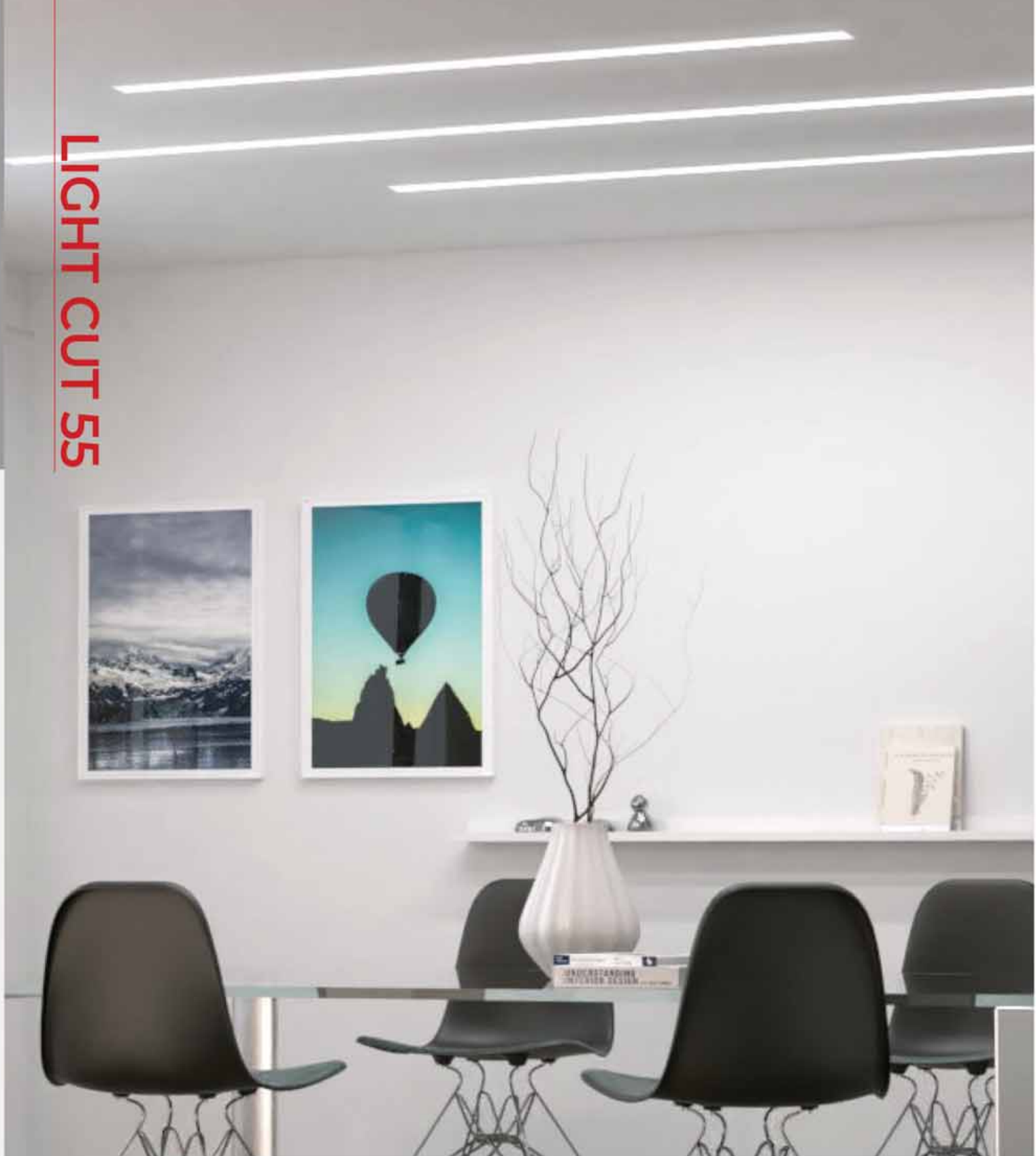

DRIVER CONSIGLIATI - RECOMMENDED DRIVERS

645038	ON-OFF	60W	IP20	24Vdc	
645216	ON-OFF	100W	IP67	24Vdc	
645179	ON-OFF	150W	IP20	24Vdc	
646371	ON-OFF	250W	IP67	24Vdc	
645687	DIM-DALI	50W	IP20	24Vdc	1-4 canali
645686	DIM-DALI	80W	IP20	24Vdc	1-4 canali

OP. A richiesta - On request; disponibile - available





- Corpo estruso in alluminio verniciato.
- Testate in alluminio verniciato.
- Schermo in policarbonato opale.
- Molle in acciaio temperato.
- Driver escluso.
- n.2 Strips Led 24V - 22+22W/m - CRI >80
- Extruded aluminum body painted.
- Aluminum heads painted.
- Polycarbonate opal screen.
- Tempered steel springs.
- Driver not included.
- n.2 Strips Led 24V - 22+22W/m - CRI >80

LIGHT CUT 55

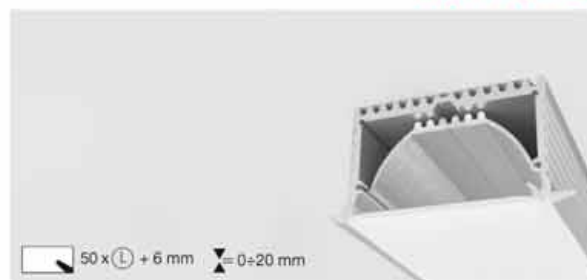

50 x (L) + 6 mm Δ = 0 ± 20 mm

SISTEMA FINITO - FINISHED SYSTEM				LUNGHEZZA mm LENGTH mm	(W)	LED (lm)	(V)	(K)	(CRI)
		Br	655-100-LBC-OP 655-100-LBN-OP	1010	44W	6000 6200	24V	3000 4000	>80
		Br	655-200-LBC-OP 655-200-LBN-OP	2010	88W	12000 12400	24V	3000 4000	>80
		Br	655-300-LBC-OP 655-300-LBN-OP	3010	132W	18000 18600	24V	3000 4000	>80

MODULO ANGOLARE - ANGULAR MODULE				LUNGHEZZA mm LENGTH mm	(W)	LED (lm)	(V)	(K)	(CRI)
		Br	655-9090-LBC-OP 655-9090-LBN-OP	198 x 198	13,2W	1800 1860	24V	3000 4000	>80

SISTEMA COMPONENTE - MODULAR SYSTEM						
KIT ESTRUSO ALLUMINIO - ALUMINUM EXTRUDED KIT			Br	980107	2 mt	VERNICIATO BIANCO - WHITE PAINTED
		Br	980108	3 mt	VERNICIATO BIANCO - WHITE PAINTED	
KIT DISSIPATORE ESTRUSO ALLUMINIO ALUMINUM EXTRUDED SINK KIT			Br	980109	2 mt	
		Br	980110	3 mt		
KIT SCHERMO PIANO - FLAT SCREEN KIT			Br	980111	2 mt	POLICARBONATO TRASPARENTE PRISMATICO - TRANSPARENT PRISMATIC POLYCARBONATE
		Br	980112	3 mt	POLICARBONATO TRASPARENTE PRISMATICO - TRANSPARENT PRISMATIC POLYCARBONATE	
		Br	980113	2 mt	POLICARBONATO OPALE - OPAL POLYCARBONATE	
		Br	980114	3 mt	POLICARBONATO OPALE - OPAL POLYCARBONATE	
KIT TESTATE DI CHIUSURA - CLOSING HEADS KIT		Br	980079	n.2 Pezzi - Pieces	TESTATE VERNICIATE BIANCO - WHITE PAINTED HEADS	
KIT MOLLE PER ANCORAGGIO - SPRING KIT FOR ANCHORING				980080	n.1 Pezzo - Piece	STAFFA CON MOLLA - BRACKET WITH SPRING
				980081	n.1 Pezzo - Piece	STAFFA PER CARTONGESSO - SPRING KIT FOR ANCHORING

STRIP LED FLEX				L (m)	TAGLIO (mm) CUT (mm)	(W)	(lm)	(V)	(K)	(CRI)
				5	50	22W	3000 3100	24Vdc	3000 4000	>80
				646195-LBC						
				646195-LBN						

LIGHT CUT 75



DRIVER CONSIGLIATI - RECOMMENDED DRIVERS

645038	ON-OFF	60W	IP20	24Vdc	
645216	ON-OFF	100W	IP67	24Vdc	
645179	ON-OFF	150W	IP20	24Vdc	
646371	ON-OFF	250W	IP67	24Vdc	
645687	DIM-DALI	50W	IP20	24Vdc	1-4 canali
645686	DIM-DALI	80W	IP20	24Vdc	1-4 canali

OP A richiesta - On request; disponibile - available



IP 20
IP 40



inside



LIGHT CUT 75

- Corpo estruso in alluminio verniciato.
- Testate in alluminio verniciato.
- Schermo in policarbonato opale.
- Driver escluso.
- n.2 Strips Led 24V - 22+22W/m - CRI >80

- Extruded aluminum body painted.
- Aluminum heads painted.
- Polycarbonate opal screen.
- Driver not included.
- n.2 Strips Led 24V - 22+22W/m - CRI >80

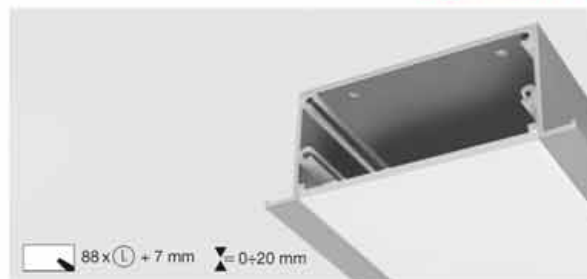

88 x (L) + 7 mm Δ = 0±20 mm

SISTEMA FINITO - FINISHED SYSTEM

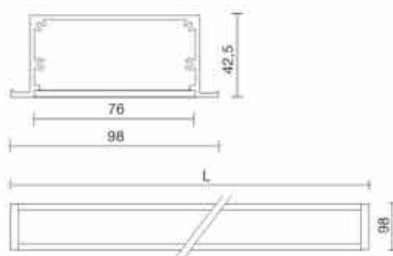

		LUNGHEZZA mm LENGTH mm	(W) LED	(lm)	(V)	(K)	(CRI)
1,17	Br 675-100-LBC-OP 675-100-LBN-OP	1010	44W	6000 6200	24V	3000 4000	>80
2,35	Br 675-200-LBC-OP 675-200-LBN-OP	2010	88W	12000 12400	24V	3000 4000	>80
3,53	Br 675-300-LBC-OP 675-300-LBN-OP	3010	132W	18000 18600	24V	3000 4000	>80

MODULO ANGOLARE - ANGULAR MODULE

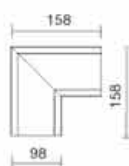

0,50	Br 675-9090-LBC-OP 675-9090-LBN-OP	158 x 158	13,2W	1800 1860	24V	3000 4000	>80
------	---------------------------------------	-----------	-------	--------------	-----	--------------	-----

SISTEMA COMPONENTE - MODULAR SYSTEM

KIT ESTRUSO ALLUMINIO - ALUMINUM EXTRUDED KIT



0,89	Br 980115	2 mt	VERNICIATO BIANCO - WHITE PAINTED
1,78	Br 980116	3 mt	VERNICIATO BIANCO - WHITE PAINTED

KIT SCHERMO PIANO - FLAT SCREEN KIT



0,44	699815	2 mt	POLICARBONATO OPALE - OPAL POLYCARBONATE
0,66	699816	3 mt	POLICARBONATO OPALE - OPAL POLYCARBONATE

KIT TESTATE DI CHIUSURA - CLOSING HEADS KIT



Br 3443 n. 2 Pezzi - Pieces

CONGIUNZIONI - CONJUNCTIONS



3444 n.1 Pezzo - Piece CONGIUNZIONE LINEARE - LINEAR CONJUNCTION

STRIP LED FLEX



	L (m)	TAGLIO (mm) CUT (mm)	(W) (m)	(lm) (m)	(V)	(K)	(CRI)
646195-LBC	5	50	22W	3000	24Vdc	3000	>80
646195-LBN				3100		4000	



CARNE
MEAT

SALUMI
COLD CUTS

PESCE
FISH AND SHELLFISH

ORTOFRUTTA
FRUIT AND VEGETABLES

LATTICINI
DAIRY AND CHEESE

PRODOTTI DA FORNO
BREAD AND PASTRY

FOOD
LIGHTING



La gamma LED FOOD, abbinata alle ottiche sviluppate da SIDE, rappresenta la migliore risposta per illuminare i banchi alimentari con soluzioni specifiche per:

CARNE, PESCE, ORTOFRUTTA, LATTICINI E PRODOTTI DA FORNO/PASTICCERIA.

Le caratteristiche di questa tecnologia si possono riassumere in: ELEVATA RESA CROMATICA, CONSISTENZA CROMATICA, BASSISSIMA EMISSIONE DI RAGGI UV ED IR, TEMPERATURA DI COLORE (K), SPETTRO DI EMISSIONE DEDICATI E DRASTICO RISPARMIO ENERGETICO.

PERCHE' SCEGLIERE I LED FOOD

- qualità migliorata dei prodotti esposti
- elevata resa cromatica
- ridotto impatto ambientale
- emissione minima di raggi UV-IR
- on/off istantaneo
- 50.000 ore di funzionamento
- abbattimento dei consumi
- abbattimento dei costi di manutenzione

The LED FOOD range, combined with the optics developed by SIDE, represents the best answer to illuminate food counters with specific solutions for:

MEAT, FISH, FRUIT AND VEGETABLES, DAIRY PRODUCTS AND BAKERY/PASTRY PRODUCTS.

The characteristics of this technology can be summarized in: HIGH COLOR RENDERING, COLOR CONSISTENCY, VERY LOW EMISSION OF UV AND IR RAYS, COLOR TEMPERATURE (K), DEDICATED EMISSION RANGE AND DRASTIC ENERGY SAVING.

WHY CHOOSE LED FOOD

- improved quality of the displayed products
- high color rendering
- reduced environmental impact
- minimal emission of UV-IR rays
- instant on / off
- 50,000 hours of operation
- reduction of consumption
- reduction of maintenance costs



FOODLIGHTING

inside



• **INCASSI – RECESSED**



NET BLOCK
FOOD
341



NET MCL
FOOD
344



TOR 15 MCL
ORIENTABILE FOOD
349



MATRIX MCL
FOOD PLUS
351

• **PROIETTORI E BINARI ELETRIFICATI – SPOT AND TRACK LIGHTS**



BEND XS 2019
FOOD
353



BEND SLIM
FOOD
354



SIRIUS MCL
FOOD PLUS
356



LUXOR XL
FOOD PLUS
357

• **SOSPENSIONI – SUSPENSIONS**



UFO 2 MCL
FOOD
359



MINI TOWER
MCL FOOD
360



AURORA XS
FOOD
363



AURORA XL
FOOD PLUS
365

• **A RICHIESTA – ON REQUEST**



NEW
ROSS
INCASSO
369



NEW
ROSS
TRACK
371



NEW
ROSS
PARETE
372



NEW
ROSS
SOSPENSIONE
373



LINEA
374



INCASSI - RECESSED
NET 13 BLOCK FOOD



125 mm $\Delta = 1+30$ mm

- Vano ottico in pressofusione di alluminio verniciato.
- Verniciatura in polveri di poliestere.
- Riflettore in alluminio purissimo.
- Raffreddamento Led passivo con dissipatore.
- Schermo di protezione Led in vetro extrachiario.
- Led durata utile: 50.000 (h) L90 B50.

- Optic tray made of painted die-cast aluminium.
- Polyester powder painting.
- Reflector in pure aluminium.
- Passive heatsink.
- Clear glass screen protection Led.
- Led life: 50.000 (h) L90 B50.

	Br	Model	Icon	LED				SISTEMA-SYSTEM		
				W	lm	V	K	W	lm	lm/W
	57558-MT		32W	2500	220-240V [900mA]	-	36W	2250	63	
	57558-FM		32W	2350	220-240V [900mA]	-	36W	2100	60	
	57558-FH		32W	4380	220-240V [900mA]	4000	36W	3850	110	
	57558-FV		32W	4085	220-240V [900mA]	3000	36W	3600	102	
	57558-GD		32W	5700	220-240V [900mA]	2700	36W	3350	95	
	57558-GDP		32W	2600	220-240V [900mA]	2400	36W	2300	65	

OP. A richiesta - On request: colori finitura Ga - finishing colours Ga
 * fascio - beam Δ

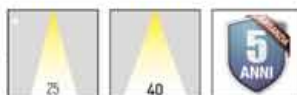

ALIMENTATORI-KIT RGB (se non in dotazione) da ordinare dalla sezione arancio - DRIVERS-RGB KITS (when not supplied) to be ordered from the section orange color

INCASSI - RECESSED









NET 15 BLOCK FOOD

- Vano ottico in pressofusione di alluminio verniciato in polveri.
- Riflettore in alluminio purissimo.
- Raffreddamento Led passivo.
- Schermo di protezione Led in policarbonato.

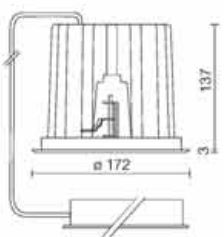
- Trim made of powder coated die-cast aluminium.
- Reflector in pure aluminium.
- Passive heatsink.
- Polycarbonate screen protection Led.



156 mm \pm 0+30 mm

NET 15 BLOCK FOOD	  	LED				SISTEMA-SYSTEM			
		W	lm	V	K	W	lm	$\frac{lm}{W}$	
	Br 57566-MT		37W	2905	220-240V [1050mA]	-	41W	2601	63
	Br 57566-FM		37W	2730	220-240V [1050mA]	-	41W	2444	60
	Br 57566-FH		37W	5025	220-240V [1050mA]	4000	41W	4498	110
	Br 57566-FV		37W	4685	220-240V [1050mA]	3000	41W	4194	102
	Br 57566-GD		37W	4265	220-240V [1050mA]	2700	41W	3818	93
	Br 57566-GDP		37W	2995	220-240V [1050mA]	2400	41W	2681	65

OP. A richiesta - On request: colori finitura Ga - finishing colours Ga

* fascio - beam 



IP 20



inside

ALIMENTATORI-KIT RGB (se non in dotazione) da ordinare dalla sezione arancio - DRIVERS-RGB KITS (when not supplied) to be ordered from the section orange color

INCASSI - RECESSED
NET 18 BLOCK FOOD







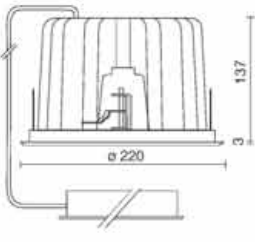

- Vano ottico in pressofusione di alluminio verniciato in polveri.
- Riflettore in alluminio purissimo.
- Raffreddamento Led passivo.
- Schermo di protezione Led in policarbonato.

- Trim made of powder coated die-cast aluminium.
- Reflector in pure aluminum.
- Passive heatsink.
- Polycarbonate screen protection Led.



205 mm Δ 1+30 mm

NET 18 BLOCK PLUS FOOD	Br	57575-MT		LED				SYSTEM-SYSTEM		
				W	lm	V	K	W	lm	lm/W
	Br	57575-FM		43W	3075	220-240V [1200mA]	-	47W	2754	59
	Br	57575-FH		43W	5656	220-240V [1200mA]	4000	47W	5066	108
	Br	57575-FV		43W	5275	220-240V [1200mA]	3000	47W	4725	101
	Br	57575-GD		43W	4800	220-240V [1200mA]	2700	47W	4299	91
	Br	57575-GDP		43W	3370	220-240V [1200mA]	2400	47W	3018	64

OR. A richiesta - On request: colori finitura Ga - finishing colours Ga



IP 20



ALIMENTATORI-KIT RGB (se non in dotazione) da ordinare dalla sezione arancio - DRIVERS-RGB KITS (when not supplied) to be ordered from the section orange color

inside

NET MCL FOOD PLUS



- Anello di finitura esterno in pressofusione di alluminio.
 - Parabola in alluminio purissimo sfaccettata anti-iridescente.
 - Vetro di protezione trasparente.
 - Fissaggio a controsoffitto con staffe regolabili in lamiera zincata.
 - Dissipatore lamellare passivo in alluminio estruso.
 - Alimentatore elettronico esterno in dotazione.
 - Led durata utile: 50.000 (h) L90 B20.
- Die-cast aluminium external ring.
 - Reflector in faceted anti-iridescent pure aluminium.
 - Transparent protection glass.
 - False-ceiling fixing with adjustable brackets made of galvanized metal sheet.
 - Passive heatsink made of extruded laminated aluminium.
 - External electronic driver supplied.
 - Led life: 50.000 (h) L90 B20.



156 mm 1+30 mm

	LED	SISTEMA-SYSTEM						
		W	lm	lm/W				
		43W	3270	220-240V [1200mA]	-	47W	2986	64
		43W	3075	220-240V [1200mA]	-	47W	2808	60
		43W	5656	220-240V [1200mA]	4000	47W	5165	110
		43W	5275	220-240V [1200mA]	3000	47W	4817	102
		43W	4800	220-240V [1200mA]	2700	47W	4383	93
		43W	3370	220-240V [1200mA]	2400	47W	3077	65

OP. A richiesta - On request: colori finitura Ga - finishing colours Ga

* fascio - beam 30



IP 20
IP 43



inside

NET MCL ORIENTABILE FOOD PLUS



- Anello di finitura esterno in pressofusione di alluminio.
 - Parabola in alluminio purissimo sfaccettata anti-iridescente.
 - Fissaggio a controsoffitto con staffe regolabili in lamiera zincata.
 - Dissipatore lamellare passivo in alluminio estruso.
 - Alimentatore elettronico esterno in dotazione.
 - Gruppo ottico orientabile sull'asse verticale +/- 30°.
 - Led durata utile: 50.000 (h) L90 B20.
- Die-cast aluminium external finishing trim ring.
 - Reflector in pure aluminium faceted anti-iridescent.
 - False-ceiling fixing with adjustable brackets made of galvanized metal sheet.
 - Passive heatsink made of extruded laminated aluminium.
 - External electronic driver supplied.
 - Adjustable optics on the vertical axis +/- 30°.
 - Led life: 50.000 (h) L90 B20.



156 mm 1+20 mm

	LED	LED			SISTEMA-SYSTEM			
		W	lm	V	K	W	lm	lm/W
Br 57585-MT-60		43W	3270	220-240V (1200mA)	-	47W	2986	64
Br 57585-FM-60		43W	3075	220-240V (1200mA)	-	47W	2808	60
Br 57585-FH-60		43W	5656	220-240V (1200mA)	4000	47W	5165	110
Br 57585-FV-60		43W	5275	220-240V (1200mA)	3000	47W	4817	102
Br 57585-GD-60		43W	4800	220-240V (1200mA)	2700	47W	4383	93
Br 57585-GDP-60		43W	3370	220-240V (1200mA)	2400	47W	3077	65

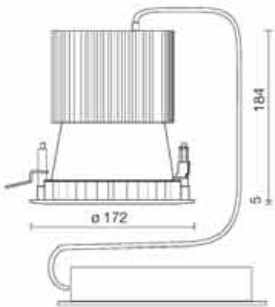

OP. A richiesta - On request: colori finitura Ga - finishing colours Ga
* fascio - beam 30°

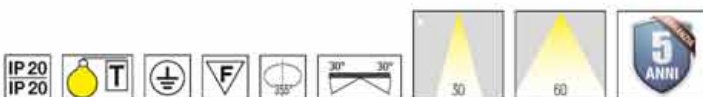

ALIMENTATORI-KIT RGB (se non in dotazione) da ordinare dalla sezione arancio - DRIVERS-RGB KITS (when not supplied) to be ordered from the section orange color







INCASSI - RECESSED

NET FLAT MCL FOOD PLUS
SENZA CORNICE - TRIMLESS

- Versione per installazione a rasamento per controsoffitti in cartongesso.
 - Parabola in alluminio purissimo sfaccettata anti-iridescente.
 - Fissaggio a controsoffitto con staffe regolabili in lamiera zincata.
 - Dissipatore lamellare passivo in alluminio estruso.
 - Alimentatore elettronico esterno in dotazione.
- Trimless version for installation in plasterboard false ceiling.
 - Reflector in pure aluminium faceted anti-iridescent.
 - False-ceiling fixing with adjustable brackets made of galvanized sheet.
 - Passive heatsink made of extruded laminated aluminium.
 - External electronic ballast supplied.

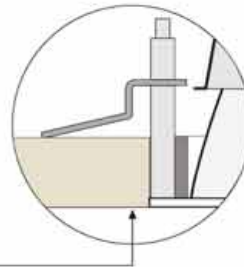

Controsoffitto in cartongesso
False-ceiling made of soft-wall



156 mm Δ = 1-30 mm

	LED	SISTEMA-SYSTEM		
		W	lm	lm/W
Br 57580R-MT-60	43W 3270	220-240V [1200mA]	-	47W 2986 64
Br 57580R-FM-60	43W 3075	220-240V [1200mA]	-	47W 2807 60
Br 57580R-FH-60	43W 5656	220-240V [1200mA]	4000	47W 5165 110
Br 57580R-FV-60	43W 5275	220-240V [1200mA]	3000	47W 4817 102
Br 57580R-GD-60	43W 4800	220-240V [1200mA]	2700	47W 4383 93
Br 57580R-GDP-60	43W 3370	220-240V [1200mA]	2400	47W 3077 65

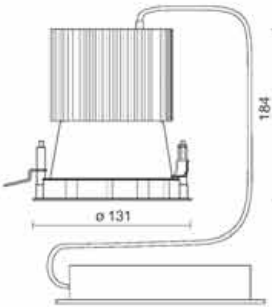

OP. A richiesta - On request: colori finitura Ga - finishing colours Ga

* fascio - beam Δ 30



ALIMENTATORI-KIT RGB (se non in dotazione) da ordinare dalla sezione arancio - DRIVERS-RGB KITS (when not supplied) to be ordered from the section orange color





TOR 15 MCL ORIENTABILE FOOD



- Corpo in pressofusione di alluminio.
- Verniciatura per interni a polveri epossidiche.
- Vetro temperato trasparente extrachiario.

- Housing and ring of die-cast aluminium.
- Epoxy powder coated for internal.
- Extra clear tempered glass.



156 mm 5+30 mm

	Br	Icon	Beam	LED				SISTEMI-SYSTEM		
				W	lm	V	K	W	lm	lm/W
	2929C-MT-S	SPOT		24W	2015	220-240V (700mA)	-	27W	1795	66
	2929C-MT-FL	FLOOD							1700	63
	2929C-MT-WF	WIDE FLOOD							1966	73
	2929C-FM-S	SPOT		24W	1895	220-240V (700mA)	-	27W	1688	63
	2929C-FM-FL	FLOOD							1599	59
	2929C-FM-WF	WIDE FLOOD							1805	67
	2929C-FH-S	SPOT		24W	3480	220-240V (700mA)	4000	27W	3099	115
	2929C-FH-FL	FLOOD							2936	109
	2929C-FH-WF	WIDE FLOOD							3395	126
	2929C-FV-S	SPOT		24W	3250	220-240V (700mA)	3000	27W	2895	107
	2929C-FV-FL	FLOOD							2742	102
	2929C-FV-WF	WIDE FLOOD							3170	117
	2929C-GD-S	SPOT		24W	2955	220-240V (700mA)	2700	27W	2632	97
	2929C-GD-FL	FLOOD							2463	92
	2929C-GD-WF	WIDE FLOOD							2883	107
	2929C-GDP-S	SPOT		24W	2075	220-240V (700mA)	2400	27W	1848	68
	2929C-GDP-FL	FLOOD							1751	65
	2929C-GDP-WF	WIDE FLOOD							2024	75

DP A richiesta versione dimmerabile - On request dimmable version



ALIMENTATORI-KIT RGB (se non in dotazione) da ordinare dalla sezione arancio - DRIVERS-RGB KITS (when not supplied) to be ordered from the section orange color















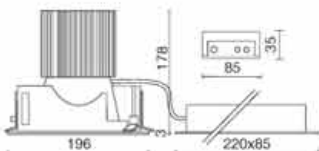

MATRIX MCL FOOD PLUS

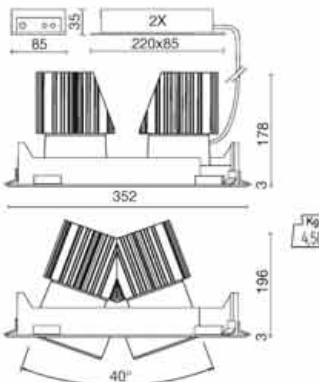

- Corpo e cornice in metallo verniciato.
- Ghiera e snodo cardanico in alluminio pressofuso.
- Fissaggio a controsoffitto con staffe regolabili
- Gruppo ottico orientabile +/- 30° su asse orizzontale e verticale
- Parabola in alluminio purissimo ossidato.

- Body and frame in painted metal.
- Trim and cardan junction in die-cast aluminium.
- False-ceiling fixing with adjustable brackets.
- Optic group adjustable +/- 30° on both horizontal-vertical axes.
- Pure oxidized aluminium reflector.

180x180 mm $\Delta = 0 \pm 30$ mm180x339 mm $\Delta = 0 \pm 30$ mm

	LED	SISTEMA-SYSTEM		
		W	lm	lm/W
				
Br 70510-MT-60		43W	3270	76
Br 70510-FM-60		43W	3075	71
Br 70510-FH-60		43W	5656	131
Br 70510-FV-60		43W	5275	123
Br 70510-GD-60		43W	4800	112
Br 70510-GDP-60		43W	3370	78
				
Br 70615-MT-60		2x43W	2x3270	152
Br 70615-FM-60		2x43W	2x3075	143
Br 70615-FH-60		2x43W	2x5656	262
Br 70615-FV-60		2x43W	2x5275	243
Br 70615-GD-60		2x43W	2x4800	224
Br 70615-GDP-60		2x43W	2x3370	156

OP. A richiesta - On request: colori finitura Ga - finishing colours Ga

* fascio - beam $\Delta = 30$

IP 20



ALIMENTATORI-KIT RGB (se non in dotazione) da ordinare dalla sezione arancio - DRIVERS-RGB KITS (when not supplied) to be ordered from the section orange color

inside





BEND XS 2019 FOOD



- Corpo in pressofusione di alluminio verniciato.
 - Verniciatura in polveri di poliestere.
 - Adattatore elettrico trifase con driver integrato.
 - Vetro di protezione.
 - Riflettore in alluminio purissimo, metallizzato in alto vuoto.
 - Led durata utile: 50.000 (h) L90 B20.
 - Costanza cromatica: 3 SDCM.
- Body made of die-cast aluminum painted.
 - Polyester powder painting.
 - Three-phase electric adapter with integrated driver.
 - Protection glass.
 - High vacuum metallized, pure aluminum reflector.
 - Led service life: 50,000 (h) L90 B20.
 - Chromatic consistency: 3 SDCM.

			LED				SISTEMA-SYSTEM			
			W	lm	V	K	W	lm	W	
	Br	67308-MT		24W	2015	220-240V [700mA]	-	27W	1678	62
	Ne	67309-MT								
	Gr	67310-MT								
	Br	67308-FM		24W	1895	220-240V [700mA]	-	27W	1578	58
	Ne	67309-FM								
	Gr	67310-FM								
Br	67308-FH		24W	3480	220-240V [700mA]	4000	27W	2898	107	
Ne	67309-FH									
Gr	67310-FH									
Br	67308-FV		24W	3250	220-240V [700mA]	3000	27W	2707	100	
Ne	67309-FV									
Gr	67310-FV									
Br	67308-GD		24W	2855	220-240V [700mA]	2700	27W	2461	91	
Ne	67309-GD									
Gr	67310-GD									
Br	67308-GDP		24W	3075	220-240V [700mA]	2400	27W	1728	64	
Ne	67309-GDP									
Gr	67310-GDP									

OP: A richiesta - On request; fascio - beam

ACC: 3079 Griglia alveolare - Alveolar grid

* In fase di approvazione - Under approval



ALIMENTATORI-KIT RGB (se non in dotazione) da ordinare dalla sezione arancio - DRIVERS-RGB KITS (when not supplied) to be ordered from the section orange color





BEND SLIM M FOOD

- Corpo in pressofusione di alluminio verniciato.
- Adattatore elettrico trifase con drivers.
- Vetro di protezione.
- Raffreddamento Led passivo.
- Riflettore in alluminio purissimo, metallizzato in alto vuoto.
- Led durata utile: 50.000 (h) L90 B20.
- Costanza cromatica: 3 SDCM.
- Fattore di potenza: 0,97.
- Isolamento SELV.
- Armoniche corrente emesse: secondo EN 61000-3-2.
- Inrush current: 5A 50us
- Temperatura ambiente: -20 +50°C.

- Body made of die-cast aluminium powder coated.
- Triphase electric adaptor with driver.
- Protection glass.
- Passive heatsink.
- High vacuum metallized, pure aluminum reflector.
- Led life: 50.000 (h) L90 B20.
- Chromatic constancy: 3 SDCM.
- Power factor: 0,97.
- SELV safety-isolation.
- Limits for harmonic current emissions as EN 61000-3-2.
- Inrush current: 5A 50us
- Working temperature: -20 +50°C.



	15°	30°	60°		LED		V	K	SISTEMA-SYSTEM			
					W	lm			W	lm	lm	
	Br 67350K-MT-15	67350K-MT-30	67350K-MT-60		37W	3270	220-240V [1200mA]	-	47W	2822	52	[15°]
	Ne 67351K-MT-15	67351K-MT-30	67351K-MT-60							2791	59	[30°]
	Ga 67352K-MT-15	67352K-MT-30	67352K-MT-60							3172	67	[60°]
	Br 67350K-FM-15	67350K-FM-30	67350K-FM-60		43W	3075	220-240V [1200mA]	-	47W	2654	56	[15°]
	Ne 67351K-FM-15	67351K-FM-30	67351K-FM-60							2625	56	[30°]
	Ga 67352K-FM-15	67352K-FM-30	67352K-FM-60							2983	63	[60°]
	Br 67350K-FH-15	67350K-FH-30	67350K-FH-60		43W	5656	220-240V [1200mA]	4000	47W	4881	104	[15°]
	Ne 67351K-FH-15	67351K-FH-30	67351K-FH-60							4737	101	[30°]
	Ga 67352K-FH-15	67352K-FH-30	67352K-FH-60							5383	114	[60°]
	Br 67350K-FV-15	67350K-FV-30	67350K-FV-60		43W	5275	220-240V [1200mA]	3000	47W	4552	97	[15°]
	Ne 67351K-FV-15	67351K-FV-30	67351K-FV-60							4503	96	[30°]
	Ga 67352K-FV-15	67352K-FV-30	67352K-FV-60							5117	109	[60°]
	Br 67350K-GD-15	67350K-GD-30	67350K-GD-60		43W	4800	220-240V [1200mA]	2700	47W	4142	88	[15°]
	Ne 67351K-GD-15	67351K-GD-30	67351K-GD-60							4097	87	[30°]
	Ga 67352K-GD-15	67352K-GD-30	67352K-GD-60							4656	99	[60°]
	Br 67350K-GDP-15	67350K-GDP-30	67350K-GDP-60		43W	3370	220-240V [1200mA]	2400	47W	2908	62	[15°]
	Ne 67351K-GDP-15	67351K-GDP-30	67351K-GDP-60							2877	61	[30°]
	Ga 67352K-GDP-15	67352K-GDP-30	67352K-GDP-60							3269	70	[60°]

ACC.	Br	3031-BR	
	Ne	3031-NE	Alette direzionali - Directional flaps
	Ga	3031-GA	



*In fase di approvazione - Under approval



ALIMENTATORI-KIT RGB (se non in dotazione) da ordinare dalla sezione arancio - DRIVERS-RGB KITS (when not supplied) to be ordered from the section orange color



BEND SLIM XL FOOD



- Corpo in pressofusione di alluminio verniciato.
- Adattatore elettrico trifase con drivers.
- Vetro di protezione.
- Raffreddamento Led passivo.
- Riflettore in alluminio purissimo, metallizzato in alto vuoto.
- Led durata utile: 50.000 (h) L90 B20.
- Costanza cromatica: 3 SDCM.
- Fattore di potenza: 0,97.
- Isolamento SELV.
- Armoniche corrente emesse: secondo EN 61000-3-2.
- Inrush current: 5A 50us
- Temperatura ambiente: -20 +50°C.

- Body made of die-cast aluminium powder coated.
- Triphase electric adaptor with driver.
- Protection glass.
- Passive heatsink.
- High vacuum metallized, pure aluminum reflector.
- Led life: 50.000 (h) L90 B20.
- Chromatic constancy: 3 SDCM.
- Power factor: 0,97.
- SELV safety-isolation.
- Limits for harmonic current emissions as EN 61000-3-2.
- Inrush current: 5A 50us
- Working temperature: -20 +50°C.

	Br	Ne	Gr	Icon	LED				SYSTEM-SYSTEM						
					W	lm	V	K	W	lm	lm'				
	67305K-MT-25	67306K-MT-25	67307K-MT-25		37W	2905	220-240V [1050mA]	-	41W	2548	62	[25°]			
	67305K-MT-60	67306K-MT-60	67307K-MT-60										2457	60	[60°]
	67305K-FM-25	67306K-FM-25	67307K-FM-25		37W	2730	220-240V [1050mA]	-	41W	2394	58	[25°]			
	67305K-FM-60	67306K-FM-60	67307K-FM-60										2309	56	[60°]
	67305K-FH-25	67306K-FH-25	67307K-FH-25		37W	5025	220-240V [1050mA]	4000	41W	4407	107	[25°]			
	67305K-FH-60	67306K-FH-60	67307K-FH-60										4250	104	[60°]
	67305K-FV-25	67306K-FV-25	67307K-FV-25		37W	4685	220-240V [1050mA]	5000	41W	4109	100	[25°]			
	67305K-FV-60	67306K-FV-60	67307K-FV-60										3962	96	[60°]
	67305K-GD-25	67306K-GD-25	67307K-GD-25		37W	4265	220-240V [1050mA]	2700	41W	3741	91	[25°]			
	67305K-GD-60	67306K-GD-60	67307K-GD-60										3606	88	[60°]
	67305K-GDP-25	67306K-GDP-25	67307K-GDP-25		37W	2995	220-240V [1050mA]	2400	41W	2627	84	[25°]			
	67305K-GDP-60	67306K-GDP-60	67307K-GDP-60										2533	82	[60°]

*In fase di approvazione - Under approval



ALIMENTATORI-KIT RGB (se non in dotazione) da ordinare dalla sezione arancio - DRIVERS-RGB KITS (when not supplied) to be ordered from the section orange color





SIRIUS MCL PLUS FOOD

- Corpo in estruso di alluminio.
- Staffa in acciaio verniciato.
- Riflettori in alluminio.
- Vetro di protezione trasparente.
- Verniciatura in polveri epossidiche.

- Body made of extruded aluminium.
- Coated steel support.
- Aluminium reflector.
- Transparent protection glass.
- Epoxy powder coated.



					LED		V	K	SISTEMA-SYSTEM			
					W	lm			W	lm	W	
	Br	67194-MT-20	67194-MT-40	67194-MT-60		43W	3270	220-240V (1200mA)	-	2822	52	(20°)
	Ne	67195-MT-20	67195-MT-40	67195-MT-60						2791	59	(40°)
	Ga	67196-MT-20	67196-MT-40	67196-MT-60						3172	67	(60°)
	Br	67194-FM-20	67194-FM-40	67194-FM-60		43W	3075	220-240V (1200mA)	-	2654	56	(20°)
	Ne	67195-FM-20	67195-FM-40	67195-FM-60						2625	56	(40°)
	Ga	67196-FM-20	67196-FM-40	67196-FM-60						2983	63	(60°)
	Br	67194-FH-20	67194-FH-40	67194-FH-60		43W	5656	220-240V (1200mA)	4000	4881	104	(20°)
	Ne	67195-FH-20	67195-FH-40	67195-FH-60						4737	101	(40°)
	Ga	67196-FH-20	67196-FH-40	67196-FH-60						5383	114	(60°)
	Br	67194-FV-20	67194-FV-40	67194-FV-60		43W	5275	220-240V (1200mA)	3000	4552	97	(20°)
	Ne	67195-FV-20	67195-FV-40	67195-FV-60						4503	96	(40°)
	Ga	67196-FV-20	67196-FV-40	67196-FV-60						5117	109	(60°)
	Br	67194-GD-20	67194-GD-40	67194-GD-60		43W	4800	220-240V (1200mA)	2700	4142	88	(20°)
	Ne	67195-GD-20	67195-GD-40	67195-GD-60						4097	87	(40°)
	Ga	67196-GD-20	67196-GD-40	67196-GD-60						4656	99	(60°)
	Br	67194-GDP-20	67194-GDP-40	67194-GDP-60		43W	3370	220-240V (1200mA)	2400	2908	62	(20°)
	Ne	67195-GDP-20	67195-GDP-40	67195-GDP-60						2877	61	(40°)
	Ga	67196-GDP-20	67196-GDP-40	67196-GDP-60						3269	70	(60°)

IP 20



inside



LUXOR XL PLUS FOOD

- Vano ottico e contenitore driver in pressofusione di alluminio verniciato in polveri.
- Adattatore elettrico trifase.
- Parabola sfaccettata in alluminio purissimo.
- Raffreddamento Led passivo.
- Vetro di protezione.

- Optic tray and driver made of powder coated die-cast aluminium.
- Electric triphase adaptor.
- Pure aluminium reflector.
- Passive Led cooling.
- Protection glass.



	LED	SISTEMA-SYSTEM								
		W	lm	lm/W						
		ORIZZONTALE PER BINARIO - HORIZONTAL FOR TRACK Br 67805-MT-60		43W	3270	220-240V (1200mA)	-	47W	2979	63
		Br 67805-FM-60		43W	3075	220-240V (1200mA)	-	47W	2801	60
		Br 67805-FH-60		43W	5656	220-240V (1200mA)	4000	47W	5153	110
		Br 67805-FV-60		43W	5275	220-240V (1200mA)	3000	47W	4805	102
		Br 67805-GD-60		43W	4800	220-240V (1200mA)	270	47W	4373	93
		Br 67805-GDP-60		43W	3370	220-240V (1200mA)	2400	47W	3070	65

	LED	SISTEMA-SYSTEM								
		W	lm	lm/W						
		VERTICALE PER BINARIO - VERTICAL FOR TRACK Br 67808-MT-60		43W	3270	220-240V (1200mA)	-	47W	2979	63
		Br 67808-FM-60		43W	3075	220-240V (1200mA)	-	47W	2801	60
		Br 67808-FH-60		43W	5656	220-240V (1200mA)	4000	47W	5153	110
		Br 67808-FV-60		43W	5275	220-240V (1200mA)	3000	47W	4806	102
		Br 67808-GD-60		43W	4800	220-240V (1200mA)	2700	47W	4373	93
		Br 67808-GDP-60		43W	3370	220-240V (1200mA)	2400	47W	3070	65

OR: A richiesta - On request colori finitura Ne - Gr / finishing colours Ne - Gr

* fascio - beam 30



ALIMENTATORI-KIT RGB (se non in dotazione) da ordinare dalla sezione arancio - DRIVERS-RGB KITS (when not supplied) to be ordered from the section orange color





UFO 2 MCL FOOD



- Corpo in lamiera di alluminio verniciata in polveri epossipoliestere.
- Riflettore in alluminio purissimo, metallizzato in alto vuoto.
- Vetro di protezione.
- Cavo di alimentazione L. 2 m.

- Sheet aluminium body in epoxy polyesterv powder coated.
- Pure aluminium reflector metallized under high vacuum.
- Protection glass.
- Power cable L. 2 m.

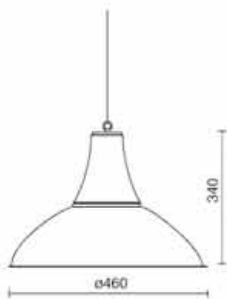

4,00 Kg

			LED				SISTEMA-SYSTEM		
			W	lm	V	K	W	lm	lm/W
Ga Br	5583-MT 5585-MT		43W	3270	220-240V [1200mA]	-	47W	2835	60
Ga Br	5583-FM 5585-FM		43W	3075	220-240V [1200mA]	-	47W	2666	57
Ga Br	5583-FH 5585-FH		43W	5656	220-240V [1200mA]	4000	47W	4903	104
Ga Br	5583-FV 5585-FV		43W	5275	220-240V [1200mA]	3000	47W	4573	97
Ga Br	5583-GD 5585-GD		43W	4800	220-240V [1200mA]	2700	47W	4161	89
Ga Br	5583-GDP 5585-GDP		43W	5370	220-240V [1200mA]	2400	47W	2922	62

OP. A richiesta trattamento di ramatura - Copper finish is a customised version with extra cost to be realised on request

ACC. Br 170 Rosone con fune acciaio 2 m. - Base plate with 2 m. steel cable
Ga 171

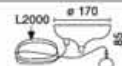

IP 20



ALIMENTATORI-KIT RGB (se non in dotazione) da ordinare dalla sezione arancio - DRIVERS-RGB KITS (when not supplied) to be ordered from the section orange color

inside

MINI TOWER MCL FOOD

- Corpo in estruso di alluminio verniciato con polveri in poliestere.
- Riflettore in alluminio verniciato e metallizzato internamente.
- Gruppo di alimentazione integrato.
- Cavo di alimentazione L. 2 m.

- Body made of extruded aluminium powder coated.
- Aluminium reflector with its interior painted and metallized.
- Built-in control gear.
- Power cable L. 2 m.



			LED				SYSTEM-SYSTEM		
			W	lm	V	K	W	lm	W
	Br 5445-MT		37W	2905	220-240V [1050mA]	-	41W	2591	63
	Br 5445-FM		37W	2730	220-240V [1050mA]	-	41W	2435	59
	Br 5445-FH		37W	5025	220-240V [1050mA]	4000	41W	4482	109
	Br 5445-FV		37W	4685	220-240V [1050mA]	3000	41W	4179	102
	Br 5445-GD		37W	4265	220-240V [1050mA]	2700	41W	3804	93
	Br 5445-GDP		37W	2995	220-240V [1050mA]	2400	41W	2672	65

OP. A richiesta con adattatore per binario SITRACK - On request with SITRACK adaptor

ACC. BI 173 Rosone con fune acciaio 2 m. - Base plate with 2 m. steel cable

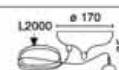

IP 20





- Corpo in estruso di alluminio verniciato con polveri in poliestere.
- Diffusore in policarbonato.
- Gruppo di alimentazione integrato.
- Cavo di alimentazione L. 2 m.

- Body made of extruded aluminium powder coated.
- Polycarbonate diffuser.
- Built-in control gear.
- Power cable L. 2 m.



1,7kg
2,70

SOSPENSIONI – SUSPENSION MINI TOWER MCL FOOD



	LED	SISTEMA-SYSTEM						
		W	lm	lm/W				
Br 5413-MT		37W	2905	220-240V (1050mA)	-	41W	2630	64
Br 5413-FM		37W	2730	220-240V (1050mA)	-	41W	2471	60
Br 5413-FH		37W	5025	220-240V (1050mA)	4000	41W	4587	112
Br 5413-FV		37W	4685	220-240V (1050mA)	3000	41W	4241	103
Br 5413-GD		37W	4265	220-240V (1050mA)	2700	41W	3861	94
Br 5413-GDP		37W	2995	220-240V (1050mA)	2400	41W	2711	66

OP. A richiesta con adattatore per binario SITRACK - On request with SITRACK adaptor

Diffusore in policarbonato opale - Opal polycarbonate diffuser: ___-P0

Diffusore in policarbonato con settore metallizzato - Partial metallized polycarbonate diffuser: ___-PA

ACC. BI 173 Rosone con fune acciaio 2 m.
Base plate with 2 m. steel cable

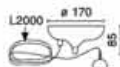

178 Kit schermo di chiusura in policarbonato completo di molle di bloccaggio
Kit polycarbonate closing screen complete with lock springs



IP 20



ALIMENTATORI-KIT RGB (se non in dotazione) da ordinare dalla sezione arancio - DRIVERS-RGB KITS (when not supplied) to be ordered from the section orange color

inside

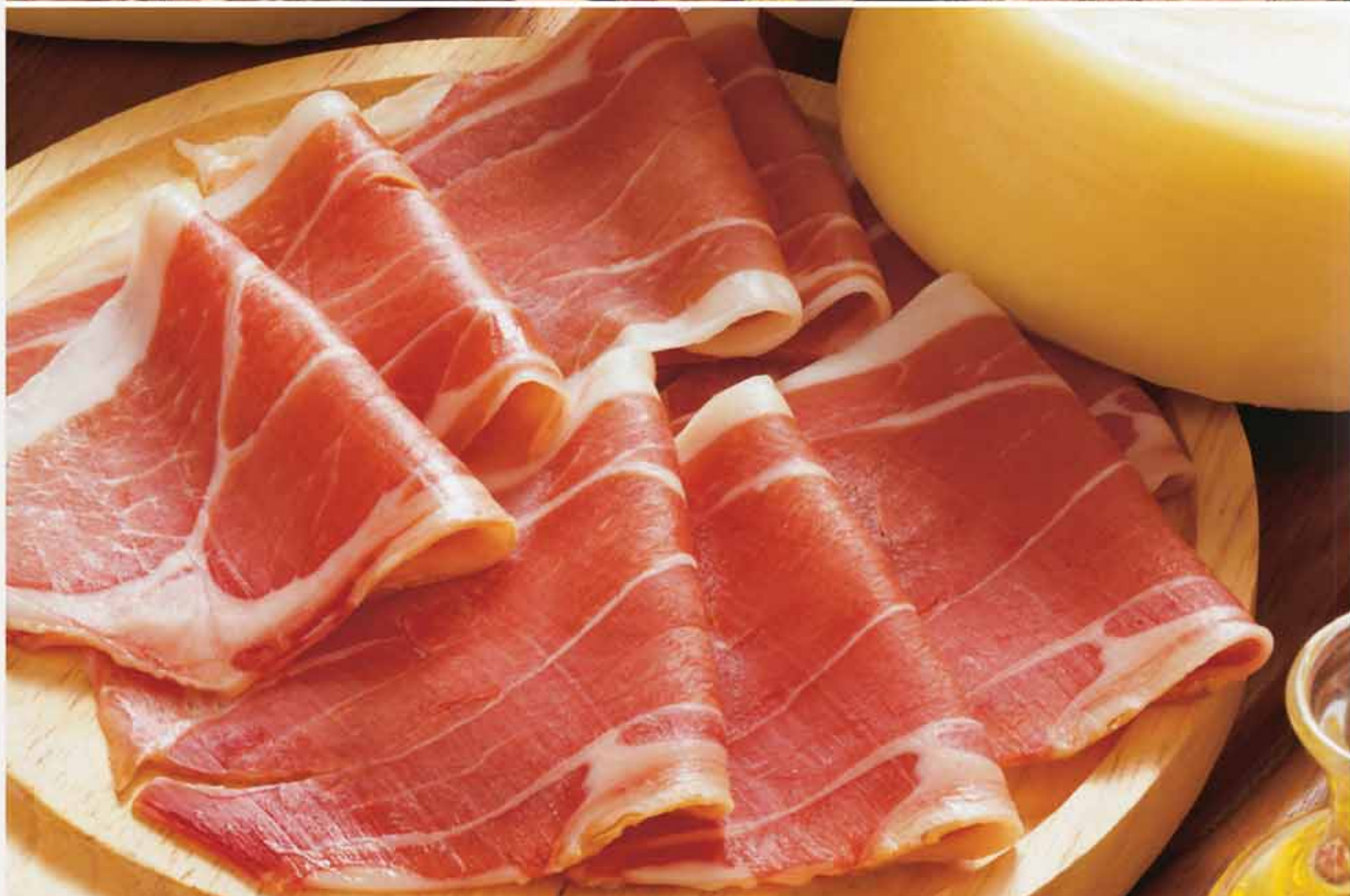

AURORA XS FOOD



- Corpo in alluminio e struttura interna in acciaio verniciati con polveri epossidiche.
- Vano ottico in pressofusione verniciato in polveri.
- Gruppo di alimentazione integrato.
- Cavo di alimentazione L 2 m.
- Parabola sfaccettata in alluminio purissimo.
- Raffreddamento Led passivo.
- Vetro di protezione.
- Led durata utile: 50.000 (h) L90 B20.
- Main body made of aluminum and steel, powder coated.
- Optic tray made of die-cast aluminum powder coated.
- Built-in control gear.
- Power cable L 2 m.
- Reflector in pure aluminum.
- Passive heatsink.
- Protection glass.
- Led life: 50.000 (h) L90 B20.

	Br	Ne	Ga	Icona	LED				SISTEMA-SYSTEM				
					W	lm	V	K	W	lm	lm/W		
	5401-MT-30	5401-MT-60			37W	2905	220-240V [1050mA]	-	41W	2592	63	[30°]	
	5402-MT-30	5402-MT-60											
	5403-MT-30	5403-MT-60											
		5401-FM-30	5401-FM-60			37W	2730	220-240V [1050mA]	-	41W	2436	59	[30°]
	5402-FM-30	5402-FM-60											
	5403-FM-30	5403-FM-60											
		5401-FH-30	5401-FH-60			37W	5025	220-240V [1050mA]	4000	41W	4484	109	[30°]
5402-FH-30	5402-FH-60												
5403-FH-30	5403-FH-60												
	5401-FV-30	5401-FV-60			37W	4685	220-240V [1050mA]	3000	41W	4181	102	[30°]	
5402-FV-30	5402-FV-60												
5403-FV-30	5403-FV-60												
	5401-GD-30	5401-GD-60			37W	4265	220-240V [1050mA]	2700	41W	3806	93	[30°]	
5402-GD-30	5402-GD-60												
5403-GD-30	5403-GD-60												
	5401-GDP-30	5401-GDP-60			37W	2995	220-240V [1050mA]	2400	41W	2673	65	[30°]	
5402-GDP-30	5402-GDP-60												
5403-GDP-30	5403-GDP-60												

OP: A richiesta con adattatore per binario SITRACK - On request with SITRACK adaptor



ALIMENTATORI-KIT RGB (se non in dotazione) da ordinare dalla sezione arancio - DRIVERS-RGB KITS (when not supplied) to be ordered from the section orange color

AURORA XL PLUS FOOD



- Corpo in alluminio e struttura interna in acciaio verniciati con polveri epossidiche.
- Vano ottico in pressofusione verniciato in polveri.
- Gruppo di alimentazione integrato.
- Cavo di alimentazione L 2 mt.
- Parabola in alluminio purissimo.
- Raffreddamento Led passivo.
- Schermo di protezione LED in policarbonato.
- Led durata utile: 50.000 (h) L90 B20.

- Main body made of aluminum and steel, powder coated.
- Optic tray made of die-cast aluminum powder coated.
- Built-in control gear.
- Power cable L 2 mt.
- Reflector in pure aluminum.
- Passive heatsink.
- Protection LED polycarbonate frame.
- Led life: 50.000 (h) L90 B20.



			LED		V	K	SYSTEM-SYSTEM			
			W	lm			W	lm	IP	
	Br	5407-MT		43W	3270	220-240V (1200mA)	-	47W	2807	68
	Ne	5408-MT								
	Ga	5409-MT								
	Br	5407-FM		43W	3075	220-240V (1200mA)	-	47W	2693	57
	Ne	5408-FM								
	Ga	5409-FM								
	Br	5407-FH		43W	5656	220-240V (1200mA)	4000	47W	4854	103
Ne	5408-FH									
Ga	5409-FH									
Br	5407-FV		43W	5275	220-240V (1200mA)	3000	47W	4527	96	
Ne	5408-FV									
Ga	5409-FV									
Br	5407-GD		43W	4800	220-240V (1200mA)	2700	47W	4120	88	
Ne	5408-GD									
Ga	5409-GD									
Br	5407-GDP		43W	3370	220-240V (1200mA)	2400	47W	2892	62	
Ne	5408-GDP									
Ga	5409-GDP									

OP: A richiesta con adattatore per binario SITRACK - On request with SITRACK adaptor

IP 20



ALIMENTATORI-KIT RGB (se non in dotazione) da ordinare dalla sezione arancio - DRIVERS-RGB KITS (when not supplied) to be ordered from the section orange color

DATI FOTOMETRICI/GUIDA ALLA SCELTA - PHOTOMETRIC DATA/CHOICE GUIDE

(W) (lm) AMPIEZZA FASCIO - BEAM WIDE

DATI FOTOMETRICI TIPICI - TYPICAL PHOTOMETRIC DATA

NET 13 BLOCK FOOD



32W 2500-3950

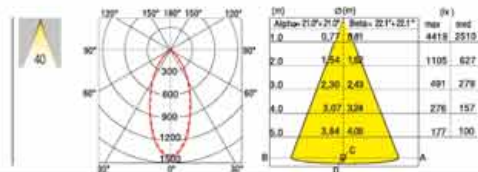

NET 15 BLOCK FOOD



37W 2730-5025

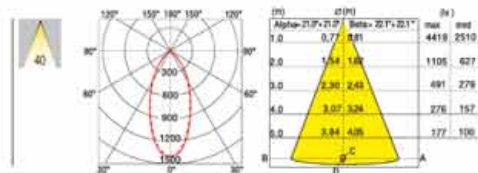

NET 18 BLOCK FOOD PLUS



43W 3075-5656

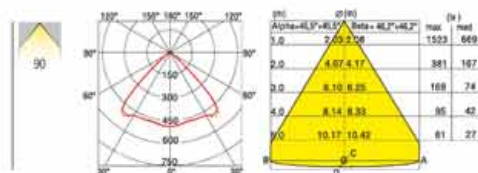

NET 15/18 MCL FOOD PLUS



43W 3075-5656

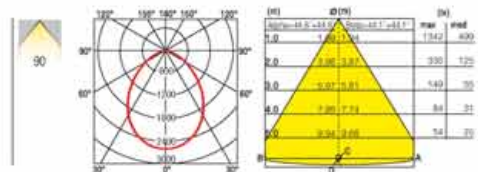

NET MCL FOOD PLUS



43W 3075-5656

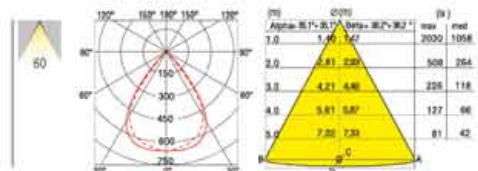
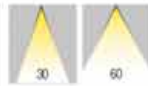

NET MCL ORIENTABILE FOOD PLUS



43W 3075-5656

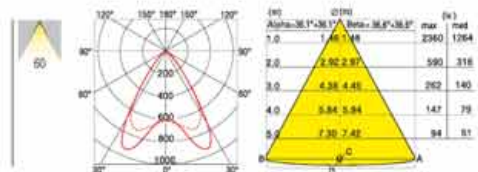
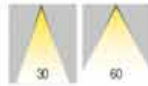

NET FLAT MCL FOOD PLUS



43W 3075-5656

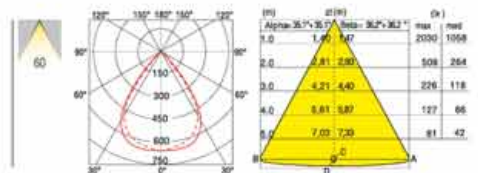
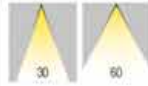

MATRIX MCL FOOD PLUS



43W 3075-5656

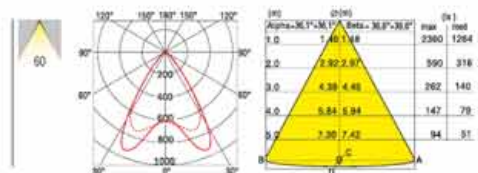
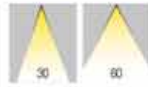







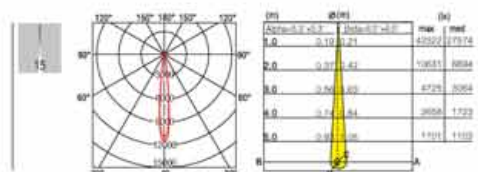
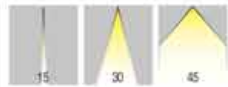





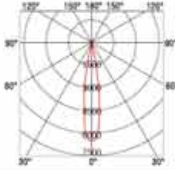



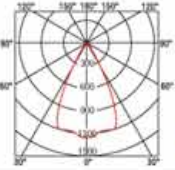











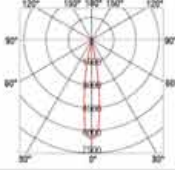



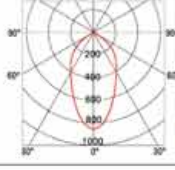



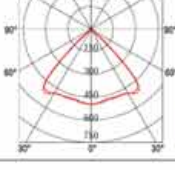

TOR 15 MCL ORIENTABILE FOOD

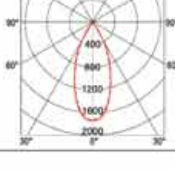

24W 1895-3480

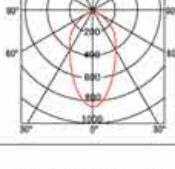

DATI FOTOMETRICI/GUIDA ALLA SCELTA - PHOTOMETRIC DATA/CHOICE GUIDE

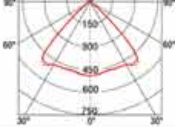
		(W)	(lm)	AMPIEZZA FASCIO - BEAM WIDE	DATI FOTOMETRICI TIPICI - TYPICAL PHOTOMETRIC DATA																					
	XS	24W	1895-3480				<table border="1"> <thead> <tr> <th>(m)</th> <th>Φ(m)</th> <th>(lx)</th> </tr> </thead> <tbody> <tr> <td>1.0</td> <td>0.34 0.34</td> <td>2495 2495</td> </tr> <tr> <td>2.0</td> <td>0.67 0.67</td> <td>624 624</td> </tr> <tr> <td>3.0</td> <td>1.01 1.01</td> <td>277 277</td> </tr> <tr> <td>4.0</td> <td>1.34 1.34</td> <td>191 191</td> </tr> <tr> <td>5.0</td> <td>1.68 1.68</td> <td>149 149</td> </tr> </tbody> </table>	(m)	Φ(m)	(lx)	1.0	0.34 0.34	2495 2495	2.0	0.67 0.67	624 624	3.0	1.01 1.01	277 277	4.0	1.34 1.34	191 191	5.0	1.68 1.68	149 149	
	(m)	Φ(m)	(lx)																							
1.0	0.34 0.34	2495 2495																								
2.0	0.67 0.67	624 624																								
3.0	1.01 1.01	277 277																								
4.0	1.34 1.34	191 191																								
5.0	1.68 1.68	149 149																								
	XS	24W	1895-3480				<table border="1"> <thead> <tr> <th>(m)</th> <th>Φ(m)</th> <th>(lx)</th> </tr> </thead> <tbody> <tr> <td>1.0</td> <td>0.34 0.34</td> <td>2495 2495</td> </tr> <tr> <td>2.0</td> <td>0.67 0.67</td> <td>624 624</td> </tr> <tr> <td>3.0</td> <td>1.01 1.01</td> <td>277 277</td> </tr> <tr> <td>4.0</td> <td>1.34 1.34</td> <td>191 191</td> </tr> <tr> <td>5.0</td> <td>1.68 1.68</td> <td>149 149</td> </tr> </tbody> </table>	(m)	Φ(m)	(lx)	1.0	0.34 0.34	2495 2495	2.0	0.67 0.67	624 624	3.0	1.01 1.01	277 277	4.0	1.34 1.34	191 191	5.0	1.68 1.68	149 149	
	(m)	Φ(m)	(lx)																							
	1.0	0.34 0.34	2495 2495																							
2.0	0.67 0.67	624 624																								
3.0	1.01 1.01	277 277																								
4.0	1.34 1.34	191 191																								
5.0	1.68 1.68	149 149																								
M	31W	2380-4380					<table border="1"> <thead> <tr> <th>(m)</th> <th>Φ(m)</th> <th>(lx)</th> </tr> </thead> <tbody> <tr> <td>1.0</td> <td>0.34 0.34</td> <td>2495 2495</td> </tr> <tr> <td>2.0</td> <td>0.67 0.67</td> <td>624 624</td> </tr> <tr> <td>3.0</td> <td>1.01 1.01</td> <td>277 277</td> </tr> <tr> <td>4.0</td> <td>1.34 1.34</td> <td>191 191</td> </tr> <tr> <td>5.0</td> <td>1.68 1.68</td> <td>149 149</td> </tr> </tbody> </table>	(m)	Φ(m)	(lx)	1.0	0.34 0.34	2495 2495	2.0	0.67 0.67	624 624	3.0	1.01 1.01	277 277	4.0	1.34 1.34	191 191	5.0	1.68 1.68	149 149	
(m)	Φ(m)	(lx)																								
1.0	0.34 0.34	2495 2495																								
2.0	0.67 0.67	624 624																								
3.0	1.01 1.01	277 277																								
4.0	1.34 1.34	191 191																								
5.0	1.68 1.68	149 149																								
XL	37W	2730-5025						<table border="1"> <thead> <tr> <th>(m)</th> <th>Φ(m)</th> <th>(lx)</th> </tr> </thead> <tbody> <tr> <td>1.0</td> <td>0.34 0.34</td> <td>2495 2495</td> </tr> <tr> <td>2.0</td> <td>0.67 0.67</td> <td>624 624</td> </tr> <tr> <td>3.0</td> <td>1.01 1.01</td> <td>277 277</td> </tr> <tr> <td>4.0</td> <td>1.34 1.34</td> <td>191 191</td> </tr> <tr> <td>5.0</td> <td>1.68 1.68</td> <td>149 149</td> </tr> </tbody> </table>	(m)	Φ(m)	(lx)	1.0	0.34 0.34	2495 2495	2.0	0.67 0.67	624 624	3.0	1.01 1.01	277 277	4.0	1.34 1.34	191 191	5.0	1.68 1.68	149 149
(m)	Φ(m)	(lx)																								
1.0	0.34 0.34	2495 2495																								
2.0	0.67 0.67	624 624																								
3.0	1.01 1.01	277 277																								
4.0	1.34 1.34	191 191																								
5.0	1.68 1.68	149 149																								
		43W	3075-5658				<table border="1"> <thead> <tr> <th>(m)</th> <th>Φ(m)</th> <th>(lx)</th> </tr> </thead> <tbody> <tr> <td>1.0</td> <td>0.34 0.34</td> <td>2495 2495</td> </tr> <tr> <td>2.0</td> <td>0.67 0.67</td> <td>624 624</td> </tr> <tr> <td>3.0</td> <td>1.01 1.01</td> <td>277 277</td> </tr> <tr> <td>4.0</td> <td>1.34 1.34</td> <td>191 191</td> </tr> <tr> <td>5.0</td> <td>1.68 1.68</td> <td>149 149</td> </tr> </tbody> </table>	(m)	Φ(m)	(lx)	1.0	0.34 0.34	2495 2495	2.0	0.67 0.67	624 624	3.0	1.01 1.01	277 277	4.0	1.34 1.34	191 191	5.0	1.68 1.68	149 149	
	(m)	Φ(m)	(lx)																							
1.0	0.34 0.34	2495 2495																								
2.0	0.67 0.67	624 624																								
3.0	1.01 1.01	277 277																								
4.0	1.34 1.34	191 191																								
5.0	1.68 1.68	149 149																								
		43W	3075-5658				<table border="1"> <thead> <tr> <th>(m)</th> <th>Φ(m)</th> <th>(lx)</th> </tr> </thead> <tbody> <tr> <td>1.0</td> <td>1.11 1.11</td> <td>2616 1224</td> </tr> <tr> <td>2.0</td> <td>2.22 2.22</td> <td>654 306</td> </tr> <tr> <td>3.0</td> <td>3.33 3.33</td> <td>291 136</td> </tr> <tr> <td>4.0</td> <td>4.44 4.44</td> <td>164 77</td> </tr> <tr> <td>5.0</td> <td>5.55 5.55</td> <td>105 49</td> </tr> </tbody> </table>	(m)	Φ(m)	(lx)	1.0	1.11 1.11	2616 1224	2.0	2.22 2.22	654 306	3.0	3.33 3.33	291 136	4.0	4.44 4.44	164 77	5.0	5.55 5.55	105 49	
	(m)	Φ(m)	(lx)																							
1.0	1.11 1.11	2616 1224																								
2.0	2.22 2.22	654 306																								
3.0	3.33 3.33	291 136																								
4.0	4.44 4.44	164 77																								
5.0	5.55 5.55	105 49																								
		43W	3075-5658				<table border="1"> <thead> <tr> <th>(m)</th> <th>Φ(m)</th> <th>(lx)</th> </tr> </thead> <tbody> <tr> <td>1.0</td> <td>2.09 2.09</td> <td>299 299</td> </tr> <tr> <td>2.0</td> <td>4.17 4.17</td> <td>118 118</td> </tr> <tr> <td>3.0</td> <td>6.25 6.25</td> <td>79 79</td> </tr> <tr> <td>4.0</td> <td>8.33 8.33</td> <td>57 57</td> </tr> <tr> <td>5.0</td> <td>10.42 10.42</td> <td>41 41</td> </tr> </tbody> </table>	(m)	Φ(m)	(lx)	1.0	2.09 2.09	299 299	2.0	4.17 4.17	118 118	3.0	6.25 6.25	79 79	4.0	8.33 8.33	57 57	5.0	10.42 10.42	41 41	
	(m)	Φ(m)	(lx)																							
1.0	2.09 2.09	299 299																								
2.0	4.17 4.17	118 118																								
3.0	6.25 6.25	79 79																								
4.0	8.33 8.33	57 57																								
5.0	10.42 10.42	41 41																								
		37W	2730-5025				<table border="1"> <thead> <tr> <th>(m)</th> <th>Φ(m)</th> <th>(lx)</th> </tr> </thead> <tbody> <tr> <td>1.0</td> <td>0.77 0.77</td> <td>929 929</td> </tr> <tr> <td>2.0</td> <td>1.54 1.54</td> <td>232 232</td> </tr> <tr> <td>3.0</td> <td>2.31 2.31</td> <td>126 126</td> </tr> <tr> <td>4.0</td> <td>3.08 3.08</td> <td>87 87</td> </tr> <tr> <td>5.0</td> <td>3.85 3.85</td> <td>64 64</td> </tr> </tbody> </table>	(m)	Φ(m)	(lx)	1.0	0.77 0.77	929 929	2.0	1.54 1.54	232 232	3.0	2.31 2.31	126 126	4.0	3.08 3.08	87 87	5.0	3.85 3.85	64 64	
	(m)	Φ(m)	(lx)																							
1.0	0.77 0.77	929 929																								
2.0	1.54 1.54	232 232																								
3.0	2.31 2.31	126 126																								
4.0	3.08 3.08	87 87																								
5.0	3.85 3.85	64 64																								
		37W	2730-5025				<table border="1"> <thead> <tr> <th>(m)</th> <th>Φ(m)</th> <th>(lx)</th> </tr> </thead> <tbody> <tr> <td>1.0</td> <td>1.11 1.11</td> <td>2616 1224</td> </tr> <tr> <td>2.0</td> <td>2.22 2.22</td> <td>654 306</td> </tr> <tr> <td>3.0</td> <td>3.33 3.33</td> <td>291 136</td> </tr> <tr> <td>4.0</td> <td>4.44 4.44</td> <td>164 77</td> </tr> <tr> <td>5.0</td> <td>5.55 5.55</td> <td>105 49</td> </tr> </tbody> </table>	(m)	Φ(m)	(lx)	1.0	1.11 1.11	2616 1224	2.0	2.22 2.22	654 306	3.0	3.33 3.33	291 136	4.0	4.44 4.44	164 77	5.0	5.55 5.55	105 49	
	(m)	Φ(m)	(lx)																							
1.0	1.11 1.11	2616 1224																								
2.0	2.22 2.22	654 306																								
3.0	3.33 3.33	291 136																								
4.0	4.44 4.44	164 77																								
5.0	5.55 5.55	105 49																								
		43W	3075-5658				<table border="1"> <thead> <tr> <th>(m)</th> <th>Φ(m)</th> <th>(lx)</th> </tr> </thead> <tbody> <tr> <td>1.0</td> <td>2.09 2.09</td> <td>1523 669</td> </tr> <tr> <td>2.0</td> <td>4.17 4.17</td> <td>381 187</td> </tr> <tr> <td>3.0</td> <td>6.25 6.25</td> <td>188 74</td> </tr> <tr> <td>4.0</td> <td>8.33 8.33</td> <td>95 42</td> </tr> <tr> <td>5.0</td> <td>10.42 10.42</td> <td>61 27</td> </tr> </tbody> </table>	(m)	Φ(m)	(lx)	1.0	2.09 2.09	1523 669	2.0	4.17 4.17	381 187	3.0	6.25 6.25	188 74	4.0	8.33 8.33	95 42	5.0	10.42 10.42	61 27	
	(m)	Φ(m)	(lx)																							
1.0	2.09 2.09	1523 669																								
2.0	4.17 4.17	381 187																								
3.0	6.25 6.25	188 74																								
4.0	8.33 8.33	95 42																								
5.0	10.42 10.42	61 27																								



FASCIO STANDARD - STANDARD BEAM

RGB ≤ 19

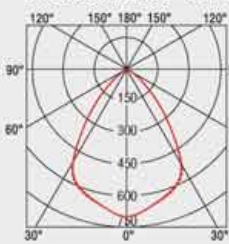

(m)	\varnothing (m)	(lx)
Alpha=36.4°+36.4° Beta=36.5°+36.5°		
1.0	1.48 1.48	max 4147 med 1983
2.0	2.95 2.96	1037 496
3.0	4.43 4.43	461 220
4.0	5.91 5.91	259 124
5.0	7.38 7.39	166 79

C180 C00 | C270 — C90

FASCIO DOPPIO ASIMMETRICO - DOUBLE ASYMMETRIC BEAM

RGB ≤ 19

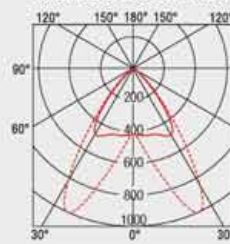

(m)	\varnothing (m)	(lx)
Alpha=18.1°+18.8° Beta=22.4°+22.4°		
1.0	0.00 0.91	max 4483 med 2700
2.0	1.20 1.80	1121 675
3.0	1.85 2.74	498 300
4.0	2.40 3.65	280 169
5.0	3.00 4.56	179 108

C180 C00 | C270 — C90

FASCIO DIFFUSO - DIFFUSED OPTIC

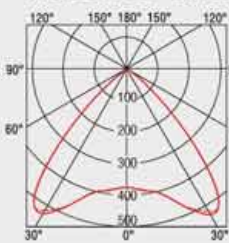

(m)	\varnothing (m)	(lx)
Alpha=43.9°+43.9° Beta=43.9°+43.9°		
1.0	1.93 1.92	max 2374 med 1333
2.0	3.85 3.84	594 333
3.0	5.78 5.77	264 148
4.0	7.70 7.69	148 83
5.0	9.63 9.61	95 53

FASCIO ASIMMETRICO - ASYMMETRIC BEAM

RGB ≤ 19

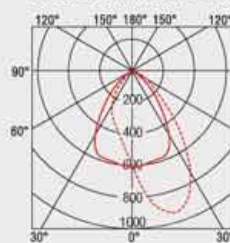

(m)	\varnothing (m)	(lx)
Alpha=23.7°+22.1° Beta=30.1°+30.1°		
1.0	0.83 1.21	max 4846 med 2509
2.0	1.66 2.43	1211 627
3.0	2.79 3.64	538 279
4.0	3.77 4.85	303 157
5.0	4.66 6.07	194 100



- Corpo in materiale termoplastico.
- Lente in PMMA.
- Dissipatore passivo.
- Temperatura esercizio -20° +35°.
- Pressacavo in nylon 66.
- Apparecchio conforme alle norme EN60598-1.
- Led durata utile: 50.000 (h) L80 B10.
- Costanza cromatica: 3 SDCM.

- Body in thermoplastic material.
- PMMA lens.
- Passive heatsink.
- Operating temperature -20 ° + 35 °.
- Nylon 66 Cable gland.
- Fitting compliant to EN60598-1 standards.
- Led life: 50.000 (h) L80 B20.
- Chromatic constancy: 3 SDCM.



					LED					SISTEMA-SYSTEM		
					W	lm	V	K	CRI	W	lm	lm
ON-OFF												
Br	4455-LBC	4457-LBC	4459-LBC	4461-LBC	43,2W	7020	220-240V	3000	>90	47,5W	6894	144
Ne	4456-LBC	4458-LBC	4460-LBC	4462-LBC			[500mA]					
Br	4455-LBN	4457-LBN	4459-LBN	4461-LBN	43,2W	7365	220-240V	4000	>90	47,5W	7233	151
Ne	4456-LBN	4458-LBN	4460-LBN	4462-LBN			[500mA]					
DALI DIM-DALI/PUSH												
Br	4455-LBC-DA	4457-LBC-DA	4459-LBC-DA	4461-LBC-DA	43,2W	7020	220-240V	3000	>90	47,5W	6894	144
Ne	4456-LBC-DA	4458-LBC-DA	4460-LBC-DA	4462-LBC-DA			[500mA]					
Br	4455-LBN-DA	4457-LBN-DA	4459-LBN-DA	4461-LBN-DA	43,2W	7365	220-240V	4000	>90	47,5W	7233	151
Ne	4456-LBN-DA	4458-LBN-DA	4460-LBN-DA	4462-LBN-DA			[500mA]					
EM EMERGENZA-EMERGENCY - 1H												
Br	4455-LBC-EM	4457-LBC-EM	4459-LBC-EM	4461-LBC-EM	43,2W	7020	220-240V	3000	>90	47,5W	6894	144
Ne	4456-LBC-EM	4458-LBC-EM	4460-LBC-EM	4462-LBC-EM			[500mA]					
Br	4455-LBN-EM	4457-LBN-EM	4459-LBN-EM	4461-LBN-EM	43,2W	7365	220-240V	4000	>90	47,5W	7233	151
Ne	4456-LBN-EM	4458-LBN-EM	4460-LBN-EM	4462-LBN-EM			[500mA]					

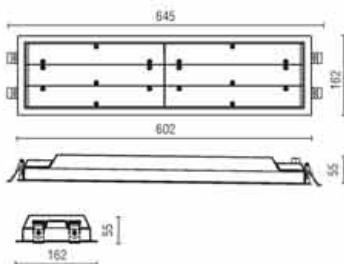

ALIMENTATORI-KIT RGB (se non in dotazione) da ordinare dalla sezione arancio - DRIVERS-RGB KITS (when not supplied) to be ordered from the section orange color





ROSS BINARIO



- Corpo in materiale termoplastico.
- Lente in PMMA.
- Dissipatore passivo.
- Temperatura esercizio -20° +35°.
- Pressacavo in nylon 66.
- Apparecchio conforme alle norme EN60598-1.
- Led durata utile: 50.000 (h) L80 B10.
- Costanza cromatica: 3 SDCM.

- Body in thermoplastic material.
- PMMA lens.
- Passive heatsink.
- Operating temperature -20° + 35°.
- Nylon 66 Cable gland.
- Fitting compliant to EN60598-1 standards.
- Led life: 50.000 (h) L80 B20.
- Chromatic constancy: 3 SDCM.

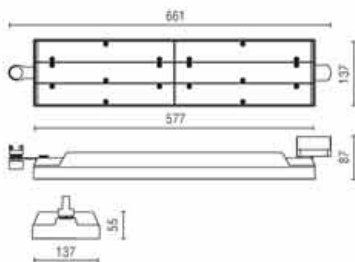

				LED					SISTEMA-SYSTEM			
	FS	FL	AS	BAS	W	lm	V	K	CRI	W	lm	lm
ON-OFF												
Br	4445-LBC	4447-LBC	4449-LBC	4451-LBC	43,5W	7020	220-240V [500mA]	3000	>80	47,5W	6894	145
Ne	4446-LBC	4448-LBC	4450-LBC	4452-LBC								
Br	4445-LBN	4447-LBN	4449-LBN	4451-LBN	43,5W	7365	220-240V [500mA]	4000	>80	47,5W	7233	152
Ne	4446-LBN	4448-LBN	4450-LBN	4452-LBN								
DALI DIM-DALI/PUSH												
Br	4445-LBC-DA	4447-LBC-DA	4449-LBC-DA	4451-LBC-DA	43,5W	7020	220-240V [500mA]	3000	>80	47,5W	6894	145
Ne	4446-LBC-DA	4448-LBC-DA	4450-LBC-DA	4452-LBC-DA								
Br	4445-LBN-DA	4447-LBN-DA	4449-LBN-DA	4451-LBN-DA	43,5W	7365	220-240V [500mA]	4000	>80	47,5W	7233	152
Ne	4446-LBN-DA	4448-LBN-DA	4450-LBN-DA	4452-LBN-DA								



ALIMENTATORI-KIT RGB (se non in dotazione) da ordinare dalla sezione arancio - DRIVERS-RGB KITS (when not supplied) to be ordered from the section orange color



A RICHIESTA – ON REQUEST

ROSS PARETE

- Corpo in materiale termoplastico.
- Lente in PMMA.
- Dissipatore passivo.
- Temperatura esercizio -20° +35°.
- Pressacavo in nylon 66.
- Apparecchio conforme alle norme EN60598-1.
- Led durata utile: 50.000 (h) L80 B10.
- Costanza cromatica: 3 SDCM.

- Body in thermoplastic material.
- PMMA lens.
- Passive heatsink.
- Operating temperature -20° +35°.
- Nylon 66 Cable gland.
- Fitting compliant to EN60598-1 standards.
- Led life: 50.000 (h) L80 B20.
- Chromatic constancy: 3 SDCM.

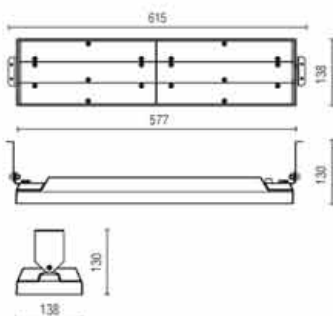

					LED					SISTEMA-SYSTEM		
					W	lm	V	K	CRI	W	lm	lm/W
ON-OFF												
Br	4465-LBC	4467-LBC	4469-LBC	4471-LBC	43,5W	7020	220-240V (500mA)	3000	>80	47,5W	6894	145
Ne	4466-LBC	4468-LBC	4470-LBC	4472-LBC								
Br	4465-LBN	4467-LBN	4469-LBN	4471-LBN	43,5W	7365	220-240V (500mA)	4000	>80	47,5W	7233	152
Ne	4466-LBN	4468-LBN	4470-LBN	4472-LBN								
Br	4465-LBC-DA	4467-LBC-DA	4469-LBC-DA	4471-LBC-DA	43,5W	7020	220-240V (500mA)	3000	>80	47,5W	6894	145
Ne	4466-LBC-DA	4468-LBC-DA	4470-LBC-DA	4472-LBC-DA								
Br	4465-LBN-DA	4467-LBN-DA	4469-LBN-DA	4471-LBN-DA	43,5W	7065	220-240V (500mA)	4000	>80	47,5W	7233	152
Ne	4466-LBN-DA	4468-LBN-DA	4470-LBN-DA	4472-LBN-DA								
Br	4465-LBC-EM	4467-LBC-EM	4469-LBC-EM	4471-LBC-EM	43,5W	7020	220-240V (500mA)	3000	>80	47,5W	6894	145
Ne	4466-LBC-EM	4468-LBC-EM	4470-LBC-EM	4472-LBC-EM								
Br	4465-LBN-EM	4467-LBN-EM	4469-LBN-EM	4471-LBN-EM	43,5W	7365	220-240V (500mA)	4000	>80	47,5W	7233	152
Ne	4466-LBN-EM	4468-LBN-EM	4470-LBN-EM	4472-LBN-EM								

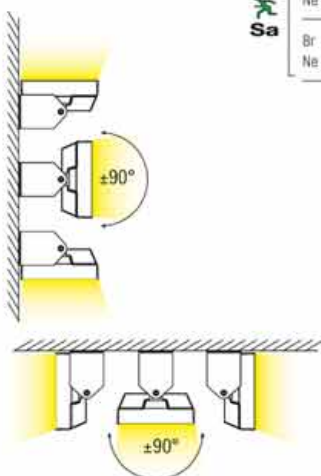



- Corpo in materiale termoplastico.
- Lente in PMMA.
- Dissipatore passivo.
- Temperatura esercizio -20° +35°.
- Pressacavo in nylon 66.
- Apparecchio conforme alle norme EN60598-1.
- Led durata utile: 50.000 (h) L80 B10.
- Costanza cromatica: 3 SDCM.

- Body in thermoplastic material.
- PMMA lens.
- Passive heatsink.
- Operating temperature -20 ° + 35 °.
- Nylon 66 Cable gland.
- Fitting compliant to EN60598-1 standards.
- Led life: 50.000 (h) L80 B20.
- Chromatic constancy: 3 SDCM.

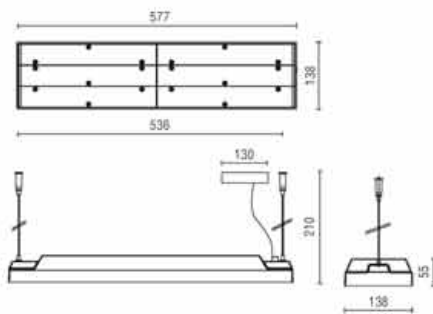

					LED					SISTEMA-SYSTEM		
					W	lm	V	K	CRI	W	lm	lm
ON-OFF												
Br	4475-LBC	4477-LBC	4479-LBC	4481-LBC	43,5W	7020	220-240V [500mA]	3000	>80	47,5W	6894	145
Ne	4476-LBC	4478-LBC	4480-LBC	4482-LBC								
Br	4475-LBN	4477-LBN	4479-LBN	4481-LBN	43,5W	7365	220-240V [500mA]	4000	>80	47,5W	7233	152
Ne	4476-LBN	4478-LBN	4480-LBN	4482-LBN								
DALI DIM-DALI/PUSH												
Br	4475-LBC-DA	4477-LBC-DA	4479-LBC-DA	4481-LBC-DA	43,5W	7020	220-240V [500mA]	3000	>80	47,5W	6894	145
Ne	4476-LBC-DA	4478-LBC-DA	4480-LBC-DA	4482-LBC-DA								
Br	4475-LBN-DA	4477-LBN-DA	4479-LBN-DA	4481-LBN-DA	43,5W	7365	220-240V [500mA]	4000	>80	47,5W	7233	152
Ne	4476-LBN-DA	4478-LBN-DA	4480-LBN-DA	4482-LBN-DA								
EM EMERGENZA-EMERGENCY - 1H												
Br	4475-LBC-EM	4477-LBC-EM	4479-LBC-EM	4481-LBC-EM	43,5W	7020	220-240V [500mA]	3000	>80	47,5W	6894	145
Ne	4476-LBC-EM	4478-LBC-EM	4480-LBC-EM	4482-LBC-EM								
Br	4475-LBN-EM	4477-LBN-EM	4479-LBN-EM	4481-LBN-EM	43,5W	7365	220-240V [500mA]	4000	>80	47,5W	7233	152
Ne	4476-LBN-EM	4478-LBN-EM	4480-LBN-EM	4482-LBN-EM								

- Rosone verniciato e cavi in acciaio con regolazione micro metrica.
- Cavo alimentazione 3/5 x 0,75mm².
- Painted canopy and steel cables with micro metric adjustment.
- Power cable: 3/5 x 0,75mm².



ALIMENTATORI-KIT RGB (se non in dotazione) da ordinare dalla sezione arancio - DRIVERS-RGB KITS (when not supplied) to be ordered from the section orange color





LINEA

- Profilo portante elettrificato in lamiera di acciaio verniciato bianco in polveri epossidiche.
 - Testata in materiale termoplastico.
 - Vano ottico Led con lenti in PMMA.
 - Dissipatore passivo.
 - Temperatura esercizio: -20 +35°.
 - Cablaggio 7 conduttori con sezione 2,5 mm² (portata max 16 A).
 - Led durata utile: 50.000 (h) L80 B10 / L80 B50.
 - Consistenza cromatica: 3 SDCM.
 - Apparecchio conforme alle norme EN 60598-1.
 - A richiesta versioni
- Electrified main structure in steel sheet white painted in epoxy powders.
 - End caps in thermoplastic material.
 - Optic with PMMA lenses.
 - Passive heatsink.
 - Working temperature: -20 +35°.
 - 7-wire wiring, section 2.5 mm² (max load 16 A).
 - Led life: 50.000 (h) L80 B10 / L80 B50.
 - Chromatic consistency: 3 SDCM.
 - Compliance with EN 60598-1.
 - On request versions



UGR ≤ 19

$$UGR = 8 \log_{10} \left[\frac{0,25}{L_b} \sum \frac{L^2 \sigma}{p^2} \right]$$

A PROFILO PORTANTE - MAIN STRUCTURE

	■ ■ ■ ■ ■	L (mm)
	4442	1415
	4444	2820

B VANO OTTICO - OPTIC TRAY

	■ ■ ■ ■ ■	LED					SYSTEM-SYSTEM				
		W	lm	V	K	CRI	W	lm	UGR		
	▲	FASCIO STANDARD STANDARD BEAM		36,2W	5850 6140	200-240V [500mA]	3000 4000	>90	40,2W	5745	143
		Br 4433-LBC 4433-LBN								6030	150
	▲	FASCIO DIFFUSO DIFFUSED BEAM		36,2W	5850 6140	200-240V [500mA]	3000 4000	>90	40,2W	5730	143
		Br 4434-LBC 4434-LBN								6020	150
	▲▲	FASCIO DOPPIO ASIMMETRICO DOUBLE ASYMMETRIC BEAM		36,2W	5850 6140	200-240V [500mA]	3000 4000	>90	40,2W	5690	143
		Br 4435-LBC 4435-LBN								5970	148
	▲	FASCIO ASIMMETRICO ASYMMETRIC BEAM		36,2W	5850 6140	200-240V [500mA]	3000 4000	>90	40,2W	5755	143
		Br 4430-LBC 4430-LBN								6040	150
	▲	FASCIO STANDARD STANDARD BEAM		72,5W	11700 12275	200-240V [500mA]	3000 4000	>90	76,5W	11490	150
		Br 4439-LBC 4439-LBN								12055	157
	▲	FASCIO DIFFUSO DIFFUSED BEAM		72,5W	11700 12275	200-240V [500mA]	3000 4000	>90	76,5W	11470	150
		Br 4440-LBC 4440-LBN								12030	157
	▲▲	FASCIO DOPPIO ASIMMETRICO DOUBLE ASYMMETRIC BEAM		72,5W	11700 12275	200-240V [500mA]	3000 4000	>90	76,5W	11380	149
		Br 4441-LBC 4441-LBN								11940	156
	▲	FASCIO ASIMMETRICO ASYMMETRIC BEAM		72,5W	11700 12275	200-240V [500mA]	3000 4000	>90	76,5W	11510	150
		Br 4432-LBC 4432-LBN								12077	158

PER APPARECCHI IN EMERGENZA - PER APPARECCHI IN EMERGENZA

KIT EMERGENZA-EMERGENCY KIT

.../6029 1h

.../6029-3 3h

C ACCESSORI			
	6017	kit gancio sospensione standard colore bianco standard suspension hook kit white colour	
	6018	kit gancio sospensione a filo colore bianco con fune acciaio L 3,1 m suspension hook kit white colour with steel cable kit L 3,1 m	
	6019	kit gancio per sospensione colore bianco a catena hook kit for chain suspension white colour	
	6020	kit elemento di giunzione, n.6 pezzi junction element kit, n.6 pieces	A richiesta - On request: Coperschio cieco - Blind cover
			6022 connettore femmina 7 poli female connector 7 poles
			6023 kit alimentazione intermedia intermediate power supply kit
			6028 testata di chiusura end cap

DP	A richiesta - On request:	versioni - versions Utilizzare driver - Use drivers	646336 40W 646337 80W
	versioni potenziate - more powerful versions	53W - 8400lm - 4000K [L 1415 mm] 105W - 16800lm - 4000K [L 2820 mm]	
	versioni con Led food - Led food version		

ESEMPIO ORDINE - ORDER EXAMPLE

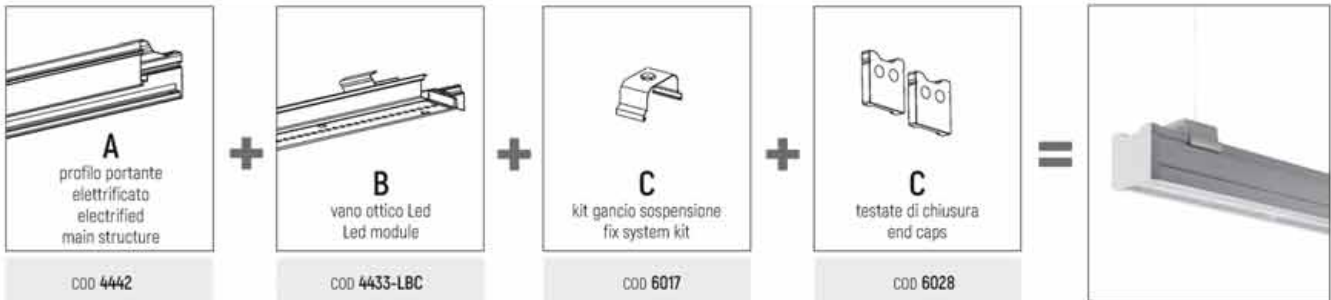

FASCIO STANDARD - STANDARD BEAM

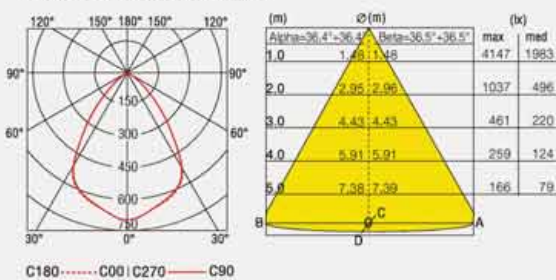

FASCIO DOPPIO ASIMMETRICO - DOUBLE ASYMMETRIC BEAM

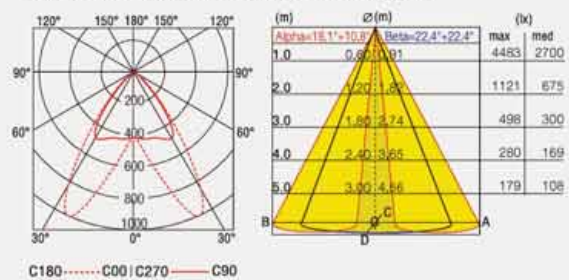

FASCIO DIFFUSO - DIFFUSED OPTIC

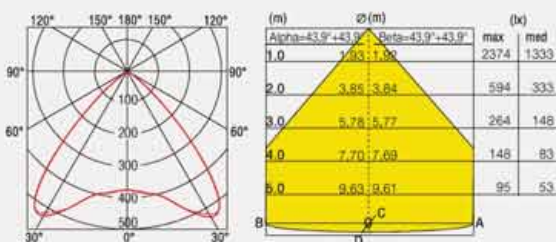

FASCIO ASIMMETRICO - ASYMMETRIC BEAM

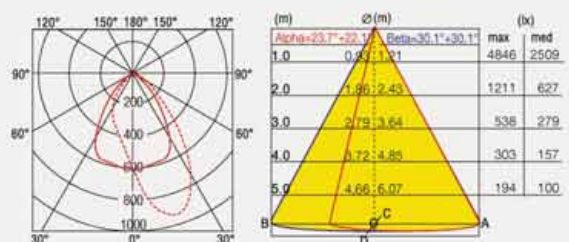

ALIMENTATORI-KIT RGB (se non in dotazione) da ordinare dalla sezione arancio - DRIVERS-RGB KITS (when not supplied) to be ordered from the section orange color





• CALPESTABILI/CARRABILI - WALK/DRIVE OVER



EYES GROUND

379



CIELO FLOOR

381

OLODUM MICRO
TONDO

383

OLODUM MICRO
QUADRO

387

OLODUM MINI
TONDO

389

OLODUM MINI
QUADRO

392

OLODUM MIDI
TONDO

394

OLODUM MIDI
QUADRO

397

OLODUM
STANDARD
TONDO

403

OLODUM
STANDARD
TONDO PROOF

407

OLODUM
STANDARD
QUADRO

408

OLODUM
STANDARD
QUADRO PROOF

409

OLODUM
MAXI

410

NEW

OLODUM-RULED
MIDI

412

NEW

OLODUM-RULED
MIDI QUADRO

413

NEW

OLODUM-RULED
STANDARD

414

NEW

OLODUM-RULED
STANDARD QUADRO

415

NEW

OLODUM-RULED
MAXI

416

NEW

OLODUM-RULED
MAXI QUADRO

417

LOCKsystem

NEW

OLODUM-RULED
MIDI PROOF

419

LOCKsystem

NEW

OLODUM-RULED
STANDARD PROOF

421

LOCKsystem

NEW

OLODUM
STANDARD PROOF

423

OLODUM MINI
FULL GLASS

425

OLODUM MIDI
FULL GLASS

427

• LINEARI - LINEAR



MINI LONGLIGHT

429



LONGLIGHT

431



LONGLIGHT SMD

433



LONGLIGHT ECO

435

LONGLIGHT ECO
ASIMMETRICO

437

• SEGNALAZIONE - STEP LIGHT



EYES COVER

439

OLODUM MICRO
COVER

440

OLODUM MICRO
PASS

440

OLODUM MICRO
COVER AL

441

OLODUM MINI
COVER AL

443

OLODUM STANDARD
COVER

445





*Solo apparecchio - Only fitting

IP 68



Carico statico 500 kg
Static load 500 kg

outside

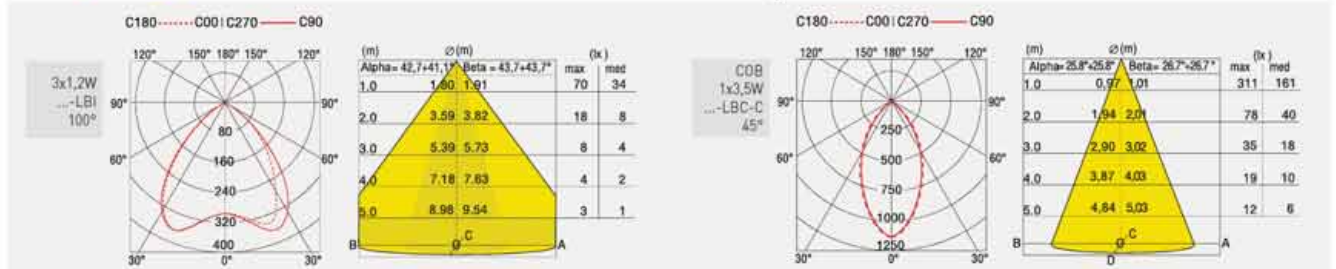

ALIMENTATORI-KIT RGB (se non in dotazione) da ordinare dalla sezione arancio - DRIVERS-RGB KITS (when not supplied) to be ordered from the section orange color



EYES GROUND IP68 COB



- Incasso in ottone cromato con Led ad alta emissione.
- Anello di finitura in acciaio Inox (AISI 316).
- Parabola metallizzata (solo COB) e vetro di protezione.

- Recessed fitting made of chromed brass provided with high emission Led.
- Stainless steel (AISI 316).
- Metallized reflector (only COB) and protection glass.

LED COB											
				INCASSO PER PAVIMENTI SOLIDI - SUITABLE FOR CONCRETE FLOORS							
				E883-N-LBC-C	1x3,5W	510	500mA	3000	>80	-	•
				E883-N-LBN-C		550	500mA	4000	>80	-	•

			APPARECCHIO + ALIMENTATORE - FITTING + DRIVER								
			INCASSO PER PAVIMENTI SOLIDI - SUITABLE FOR CONCRETE FLOORS								
			KTE883N-LBC-C	4,5W	350	220-240V	3000	>80	-	•	-
			KTE883N-LBN-C		380	(500mA)	4000	>80	-	•	

	186-6	Cassaforma da interrare per alimentatore con doppio pressacavo PG7 per cavi da 3-6mm tipo H05RN-FZG 0,75mm	
		Housing to bury for driver housing with double PG7 cable gland for 3-6mm cable type H05RN-FZG 0,75mm	
		Usare ALIMENTATORE - Use DRIVER: 646731	

186-7	Cassaforma da interrare senza alimentatore Housing to bury for without driver	
--------------	--	--



*Solo apparecchio - Only fitting

IP65
IK07



Carico statico 500 kg
Static load 500 kg

outside

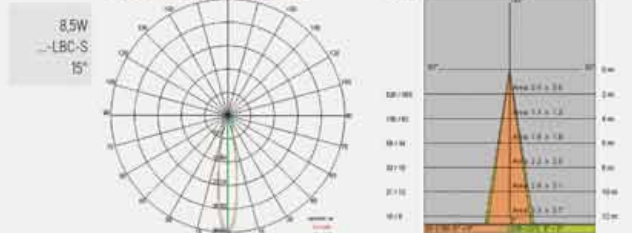
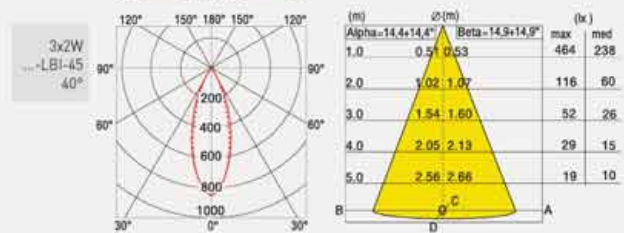
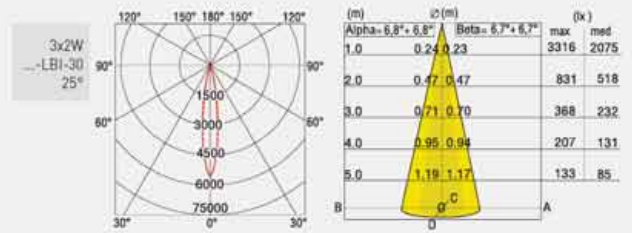
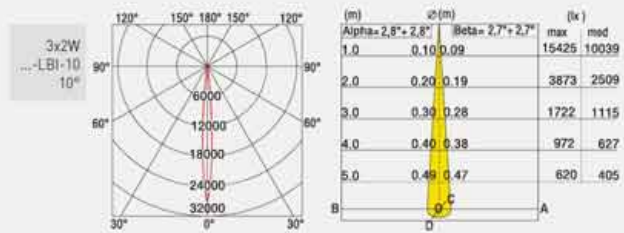

ALIMENTATORI-KIT RGB (se non in dotazione) da ordinare dalla sezione arancio - DRIVERS-RGB KITS (when not supplied) to be ordered from the section orange color

CIELO FLOOR/COB



- Corpo in pressofusione di alluminio verniciato in polveri con pretrattamento per esterni.
- Dissipatore in alluminio.
- Anello in acciaio Inox satinato.
- Cassaforma da murare in materiale termoplastico (da ordinare a parte).
- Vetro di protezione trasparente temperato.
- Pressacavo in ottone nichelato PG7.

- Die-cast aluminium body with special powder coating for outdoor use.
- Aluminium heatsink.
- Satin stainless steel ring.
- Housing made of thermoplastic material (to be ordered separately).
- Tempered transparent protection glass.
- Brass nickel PG7 cable gland.



		10	25	40	W	lm	V	K	CRI	T	IP
	Inox	E8140F-RGB-10	E8140F-RGB-30	E8140F-RGB-45	3x1,2W	-	350mA		-	-	-

LED COB

		E8140F-MLBC25		E8140F-MLBC40		W	lm	V	K	CRI	T	IP
	Inox	E8140F-MLBN25	E8140F-MLBN40	5,2W	700	150mA	3000	>90	-	-	-	

		E8140F-MLBC-AS		E8140F-MLBN-AS		W	lm	V	K	CRI	T	IP
	Inox	E8140F-MLBC-AS	E8140F-MLBN-AS	4,2W	540	350mA	3000	>80	-	-	-	

ALIMENTATORI CONSIGLIATI - DRIVERS RECOMMENDED

646397	ON-OFF	6W	IP67	150mA
646209	ON-OFF	6W	IP20	150mA

		KIT		LED								SISTEMA-SYSTEM		
		APPARECCHIO + ALIMENTATORE FITTING + DRIVER		W	lm	V	K	CRI	T	IP	W	lm	IP	
		LUCE SIMMETRICA - SYMMETRIC LIGHT		5,2W	700	150mA	3000	>90	-	-	6,2W	673	109	[25°]
		Inox	KE8140FMLBC25 KE8140FMLBN25											
		LUCE ASIMMETRICA - ASYMMETRIC LIGHT		4,2W	540	220-240V	3000	>80	-	-	4,2W	515	120	[40°]
Inox	KE8140FMLBCAS KE8140FMLBNAS													

■ Valori riferiti a 5000K - Data referred to 5000K

ACC. 185-C Cassaforma per Incasso in materiale termoplastico
Housing for recessed made of thermoplastic material

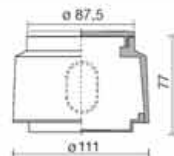

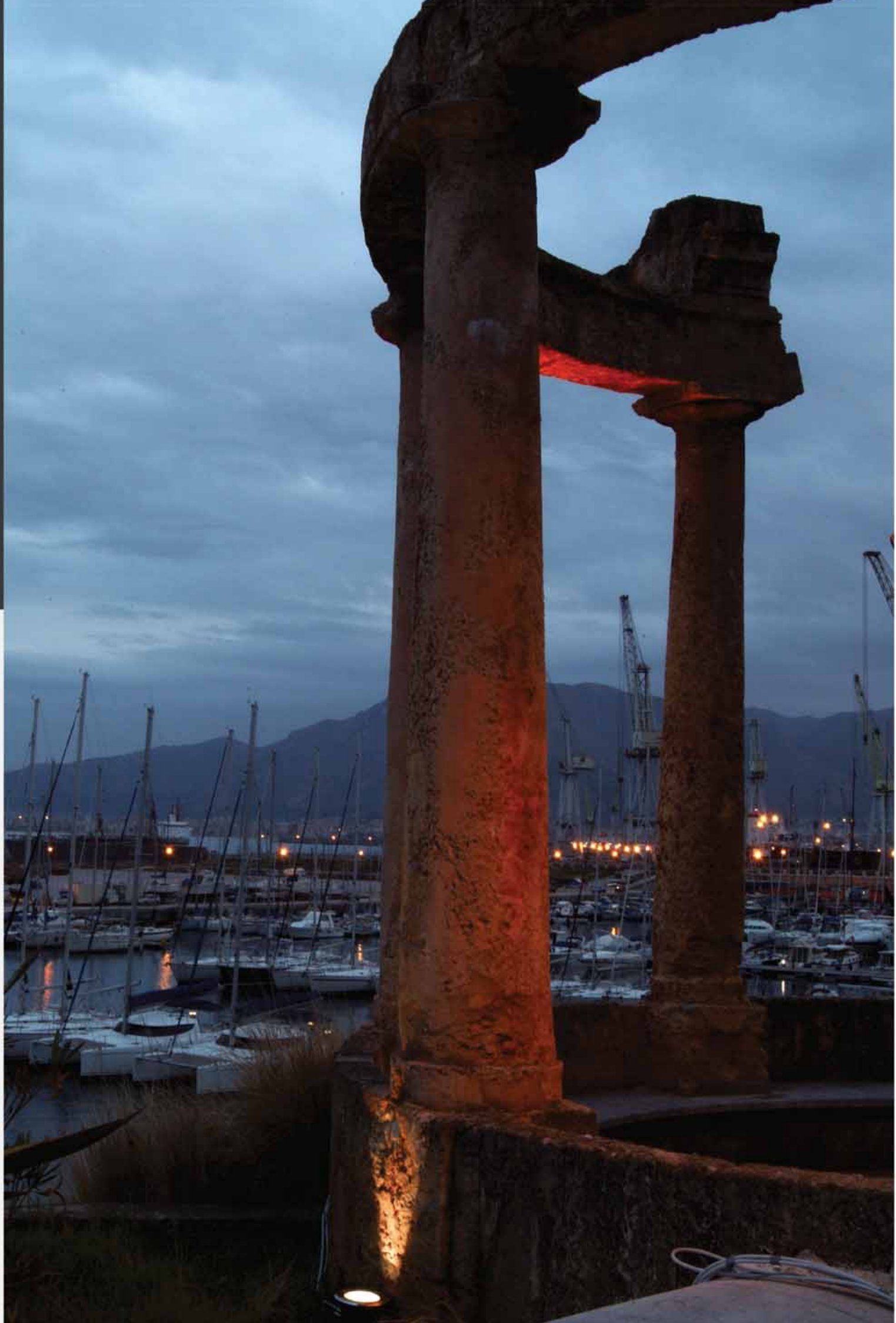

OLODUM MICRO TONDO/COB



- Corpo in acciaio Inox (AISI 316L).
- Guarnizione in gomma silconica.
- Vetro di protezione temperato trasparente.
- Anello di finitura e viti in acciaio Inox (AISI 316L).
- Cassaforma di contenimento in PA (da ordinare a parte).
- Pressacavo in ottone nichelato PG7 (diametro cavi utilizzabili 5+7mm).
- Housing of stainless steel (AISI 316L).
- Silicon rubber gaskets.
- Tempered protection glass.
- Stainless steel (AISI 316L) ring and screws.
- External housing made of PA (to be ordered separately).
- PG7 nickel brass cable gland [use cables with diameter 5+7mm].



			W	lm	V	K	CRI	T			
	Inox	E8394-RGB-SM	190	3,5W	-	350mA		43°	•	-	
	Inox	E8395-LBC-SM E8395-LBN-SM	15	4,2W	540 600	350mA	3000 4000	>80	50°	•	-
	Inox	E8495-LBC-SM E8495-LBN-SM	15	4,2W	540 600	12-24Vdc	5000 4000	>80	50°	•	-

ALIMENTATORI CONSIGLIATI - DRIVERS RECOMMENDED

645543	ON-OFF	6W	IP67	350mA
644759-1	ON-OFF	15W	IP20	350mA

			W	lm	V	K	CRI	T			
	Inox	E8494-LBC-SM E8494-LBN-SM	45	3,5W	350	350mA	3000 4000	>80	65°	•	-

ALIMENTATORI CONSIGLIATI - DRIVERS RECOMMENDED

645543	ON-OFF	6W	IP67	350mA
644759-1	ON-OFF	15W	IP20	350mA

DP: Disponibile alimentatore in emergenza - Safety driver available

-TSC TORX Viti di sicurezza - Safety screws

ACC. 185 Cassaforma per incasso - Housing for recessed



646308 Connettore IP68 Ø da 7 a 12mm - IP68 connector Ø from 7 to 12mm

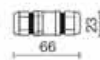

IK 07
IP 67



Carico statico 500 kg
Static load 500 kg

outside

C180 C00 | C270 C90

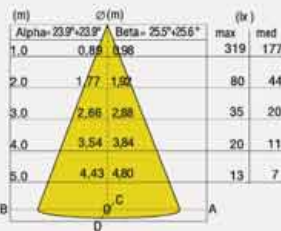
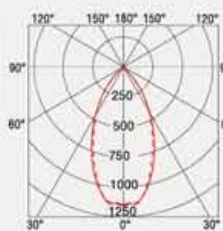

ALIMENTATORI-KIT RGB (se non in dotazione) da ordinare dalla sezione arancio - DRIVERS-RGB KITS (when not supplied) to be ordered from the section orange color





- Corpo in acciaio Inox (AISI 316L).
- Guarnizione in gomma silconica.
- Vetro di protezione temperato.
- Anello di finitura e viti in acciaio Inox (AISI 316L).
- Cassaforma di contenimento in PA (da ordinare a parte).
- Pressacavo in ottone nichelato PG7 (diametro cavi utilizzabili 5-7mm).

- Housing of stainless steel (AISI 316L).
- Silicon rubber gaskets.
- Tempered protection glass.
- Stainless steel (AISI 316L) ring and screws.
- External housing made of PA (to be ordered separately).
- PG7 nickel brass cable gland (use cables with diameter 5-7mm).

OLODUM FLAT MICRO TONDO/COB

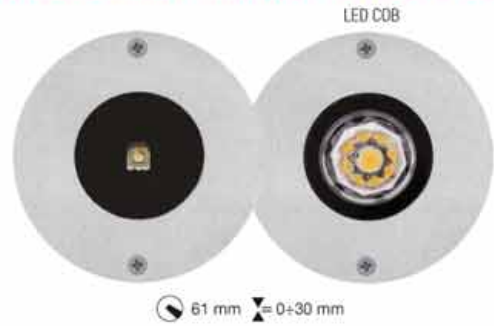

			W	lm	V	K	CRI	T			
	Inox	E8394-RGB	100	3,5W	-	350mA		43°	•	-	
	Inox	E8395-LBC E8395-LBN	15	4,2W	540 600	350mA	3000 4000	>80	50°	•	-
	Inox	E8495-LBC E8495-LBN	15	4,2W	540 600	12-24Vdc	3000 4000	>80	50°	•	-

ALIMENTATORI CONSIGLIATI - DRIVERS RECOMMENDED

645543	ON-OFF	6W	IP67	350mA
644759-1	ON-OFF	15W	IP20	350mA

			W	lm	V	K	CRI	T			
	Inox	E8494-LBC-SM E8494-LBN-SM	45	3,5W	350	350mA	3000 4000	>80	65°	•	-

ALIMENTATORI CONSIGLIATI - DRIVERS RECOMMENDED

645543	ON-OFF	6W	IP67	350mA
644759-1	ON-OFF	15W	IP20	350mA

DP: Disponibile alimentatore in emergenza - Safety driver available

-TSC TORX Viti di sicurezza - Safety screws

ACC. 185 Cassaforma per incasso - Housing for recessed



646308 Connettore IP68 Ø da 7 a 12mm - IP68 connector Ø from 7 to 12mm

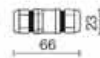

IK 07
IP 67



Carico statico 500 kg
Static load 500 kg

outside

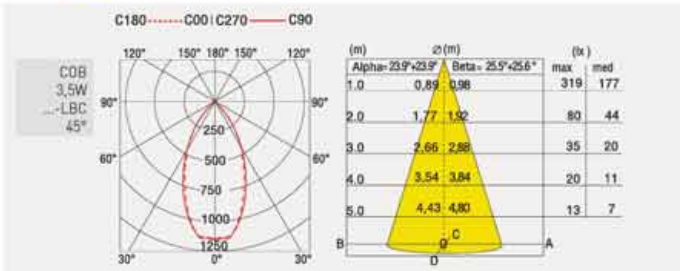

ALIMENTATORI-KIT RGB (se non in dotazione) da ordinare dalla sezione arancio - DRIVERS-RGB KITS (when not supplied) to be ordered from the section orange color



OLODUM MICRO QUADRO/COB



- Corpo in acciaio Inox (AISI 316L).
- Guarnizione in gomma silconica.
- Vetro di protezione temperato.
- Anello di finitura e viti in acciaio Inox (AISI 316L).
- Cassaforma di contenimento in PA (da ordinare a parte).
- Pressacavo in ottone nichelato PG7 (diametro cavi utilizzabili 5+7mm).

- Housing of stainless steel (AISI 316L).
- Silicon rubber gaskets.
- Tempered protection glass.
- Stainless steel (AISI 316L) ring and screws.
- External housing made of PA (to be ordered separately).
- PG7 nickel brass cable gland (use cables with diameter 5+7mm).



61 mm Δ 0÷30 mm

			W	lm	V	K	CRI	T		
	Inox	E8394-RGB-SMQ	3,5W	-	350mA		-	43°	•	-
	Inox	E8395-LBC-SMQ E8395-LBN-SMQ	4,2W	540 600	350mA	3000 4000	>80	50°	•	-
	Inox	E8495-LBC-SMQ E8495-LBN-SMQ	4,2W	540 600	12-24Vdc	3000 4000	>80	50°	•	-
	ALIMENTATORI CONSIGLIATI - DRIVERS RECOMMENDED									
	645543	ON-OFF	6W	IP67	350mA					
	644759-1	ON-OFF	15W	IP20	350mA					

			W	lm	V	K	CRI	T		
	Inox	E8494-LBC-SMQ E8494-LBN-SMQ	3,5W	350 380	350mA	3000 4000	>80	65°	•	-
	ALIMENTATORI CONSIGLIATI - DRIVERS RECOMMENDED									
	645543	ON-OFF	6W	IP67	350mA					
	644759-1	ON-OFF	15W	IP20	350mA					
DP: Disponibile alimentatore in emergenza - Safety driver available -TSC TORX Viti di sicurezza - Safety screws										
ACC.	185	Cassaforma per incasso - Housing for recessed								
	646308	Connettore IP68 \varnothing da 7 a 12mm - IP68 connector \varnothing from 7 to 12mm								



Carico statico 500 kg
Static load 500 kg

outside

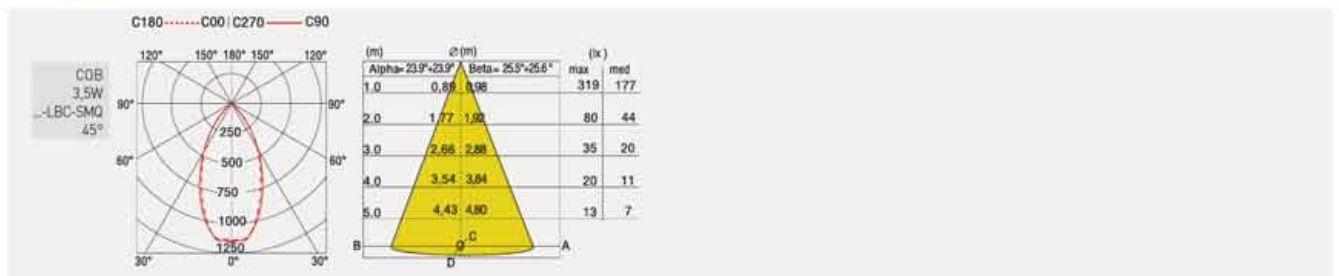

ALIMENTATORI-KIT RGB (se non in dotazione) da ordinare dalla sezione arancio - DRIVERS-RGB KITS (when not supplied) to be ordered from the section orange color

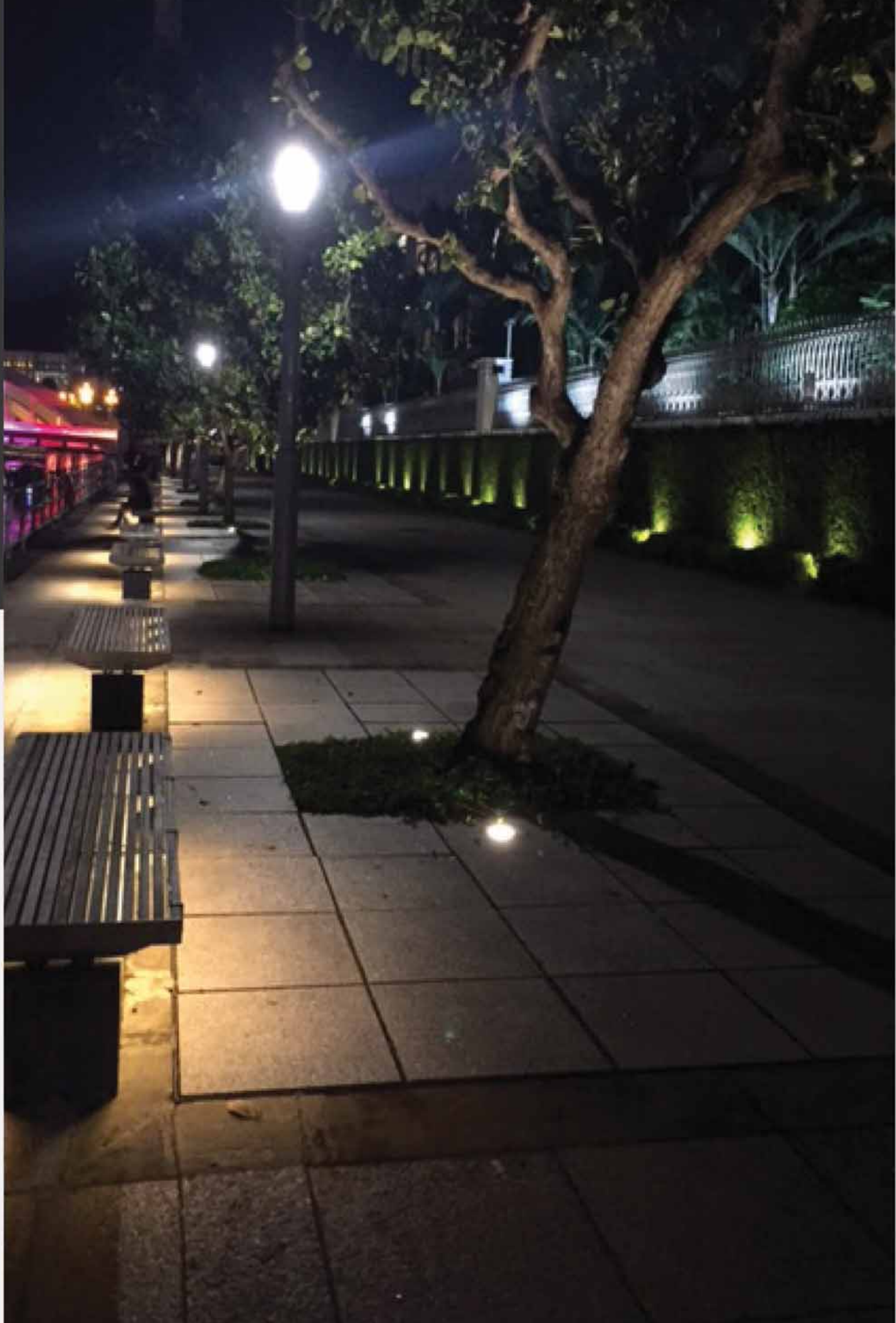

OLODUM MINI TONDO COB



- Corpo in pressofusione di alluminio verniciato in polveri con pretrattamento speciale per esterni.
- Anello di finitura in acciaio Inox (AISI 316).
- Pressacavo in ottone nichelato PG11.
- Vetro temperato di spessore 10 mm.
- Body in die-cast aluminium with special powder treatment for outdoor use.
- Stainless steel (AISI 316) frame.
- PG11 nickel brass cable gland.
- Tempered glass, 10 mm thick.

LED COB + DRIVER		LED								SYSTEM-SYSTEM			
		W	lm	V	K	⊕	CRI	T	⊕	W	lm	⊕	
Inox	E8184C-LBC-15	12,3W	1040	220-240V (350mA)	3000	⊕	>90	55°	•	•	14,3W	896	62
	E8184C-LBC-24	12,9W	1430								14,9W	1207	81
	E8184C-LBC-40	12,9W	1340								14,9W	1136	76
Inox	E8184C-LBN-15	12,3W	1120	220-240V (350mA)	4000	⊕	>90	55°	•	•	14,3W	965	67
	E8184C-LBN-24	12,9W	1510								14,9W	1274	86
	E8184C-LBN-40	12,9W	1430								14,9W	1194	80

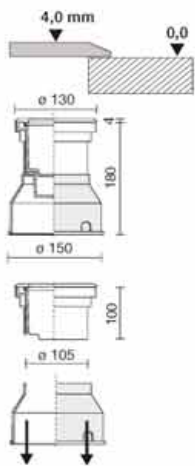

1,90 Kg

ACC. 646308 Connettore IP68 Ø da 7 a 12mm - IP68 connector Ø from 7 to 12mm
 E960 Ventosa per rimuovere vetro - Glass remover



outside

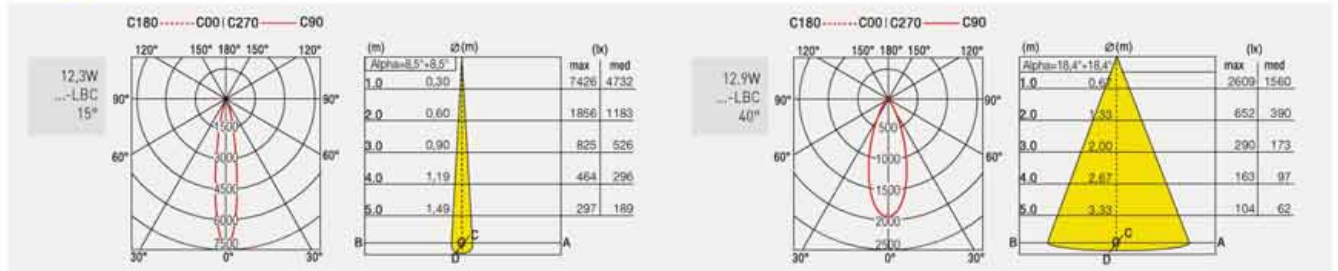

ALIMENTATORI-KIT RGB (se non in dotazione) da ordinare dalla sezione arancio - DRIVERS-RGB KITS (when not supplied) to be ordered from the section orange color



OLODUM FLAT MINI TONDO COB



- Corpo in pressofusione di alluminio verniciato in polveri con pretrattamento speciale per esterni.
- Anello di finitura in acciaio Inox (AISI 316).
- Pressacavo in ottone nichelato PG11.
- Vetro temperato di spessore 10 mm.
- Body in die-cast aluminium with special powder pre-treatment for outdoor use.
- Stainless steel (AISI 316) frame.
- PG11 nickel brass cable gland.
- Tempered glass, 10 mm thick.

LED COB	IncoX	E8384CT-LBC15 E8384CT-LBC24 E8384CT-LBC40	E8384CT-LBN15 E8384CT-LBN24 E8384CT-LBN40	LED						SISTEMA-SYSTEM				
				W	lm	V	K	°	CRI	T	W	lm	lm/W	
				12,3W	1040	350mA	3000	>90	55°	•	•	14,3W	896	62
				12,9W	1430	350mA	4000	>90	55°	•	•	12,9W	1207	81
				12,9W	1340							12,9W	1176	76
				12,3W	1120							14,3W	965	67
				12,9W	1510							14,9W	1274	86
				12,9W	1430							14,9W	1194	76

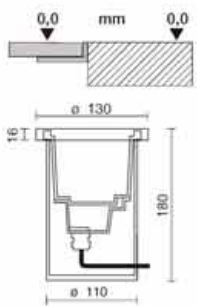

5Kg
2,10

ACC. 646308 Connettore IP68 Ø da 7 a 12mm - IP68 connector Ø from 7 to 12mm

E960 Ventosa per rimuovere vetro - Glass remover



*Solo apparecchio - Only fitting

IK 07
IP 67



outside

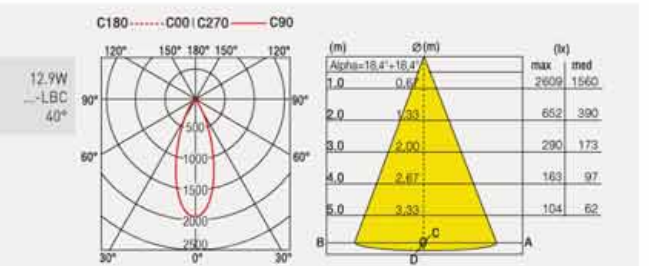
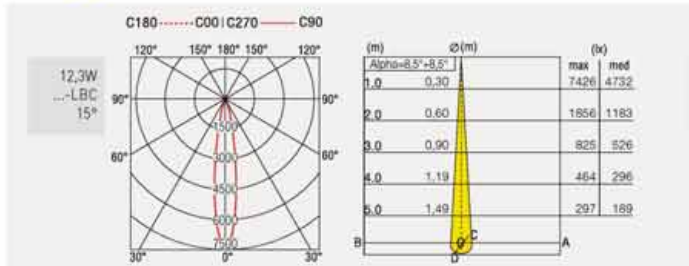

ALIMENTATORI-KIT RGB (se non in dotazione) da ordinare dalla sezione arancio - DRIVERS-RGB KITS (when not supplied) to be ordered from the section orange color



OLODUM MINI QUADRO COB

- Corpo in pressofusione di alluminio, verniciato in polveri con pretrattamento speciale per esterni.
- Anello di bloccaggio del vetro in acciaio Inox (AISI 316).
- Vetro in cristallo temperato e trasparente di spessore 10 mm.
- Completo di pozzetto in materiale termoplastico e di guarnizione in silicone.
- Pressacavo in ottone nichelato PG11.



- Spot made of die-cast aluminium, powder coated with pretreatment for outdoor use.
- Stainless steel (AISI 316) frame.
- Finishing tempered glass 10 mm thick.
- Gasket of glass and cover in silicone rubber with external housing of thermoplastic material.
- Cable gland of nickel plated brass with predisposition for through wiring PG11.

LED COB	LED	W	lm	V	K	CRI	T	SISTEMA-SYSTEM	W	lm	lm/W			
												W	lm	lm/W
	Inox	E7120C-LBC15	12,3W	1040	350mA	3000	>90	45°	•	•		14,3W	896	62
	E7120C-LBC24	12,9W	1430	14,9W								1207	81	
	E7120C-LBC40	12,9W	1340	14,9W								1136	76	
	Inox	E7120C-LBN15	12,3W	1120	350mA	4000	>90	45°	•	•		14,3W	965	67
	E7120C-LBN24	12,9W	1510	14,9W								1274	81	
	E7120C-LBN40	12,9W	1430	14,9W								1194	80	

OP. -TSC TORX Viti di sicurezza - Safety screws

ACC. **646308** Connettore IP68 Ø da 7 a 12mm - IP68 connector Ø from 7 to 12mm



E960 Ventusa per rimuovere vetro - Glass remover



outside

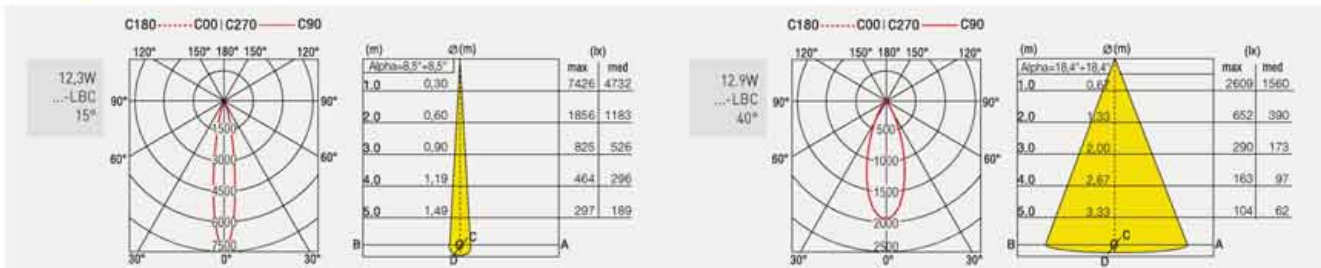

ALIMENTATORI-KIT RGB (se non in dotazione) da ordinare dalla sezione arancio - DRIVERS-RGB KITS (when not supplied) to be ordered from the section orange color



OLODUM FLAT MINI QUADRO COB



- Corpo in pressofusione di alluminio, verniciato in polveri con pretrattamento speciale per esterni.
- Anello di bloccaggio del vetro in acciaio Inox (AISI 316).
- Vetro in cristallo temperato e trasparente di spessore 10 mm.
- Completo di pozzetto in materiale termoplastico e di guarnizione in silicone.
- Pressacavo in ottone nichelato PG11.
- Body in die-cast aluminium with special powder treatment for outdoor use.
- Stainless steel (AISI 316) frame.
- Finishing tempered glass 10 mm thick.
- Gasket of glass and cover in silicone rubber with external housing of thermoplastic material.
- Cable gland of nickel plated brass with predisposition for through wiring PG11.

LED COB + DRIVER	LED	SISTEMA-SYSTEM										
		W	lm	V	K	°	CRI	T	°	W	lm	lm/W
Inox E8384C-LBC-15 E8384C-LBC-24 E8384C-LBC-40	12,3W 1040	14,3W	896	62								
	12,9W 1430	14,9W	1207	81								
	12,9W 1340	14,9W	1136	76								
Inox E8384C-LBN-15 E8384C-LBN-24 E8384C-LBN-40	12,3W 1120	14,3W	965	67								
	12,9W 1510	14,9W	1174	88								
	12,9W 1430	14,9W	1194	80								

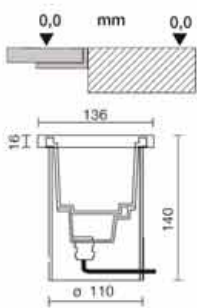

- OP. Disponibile alimentatore in emergenza - Safety driver available
 TSC TORX Viti di sicurezza - Safety screws
- ACC. 646308 Connettore IP68 ø da 7 a 12mm - IP68 connector ø from 7 to 12mm
 E960 Ventosa per rimuovere vetro - Glass remover

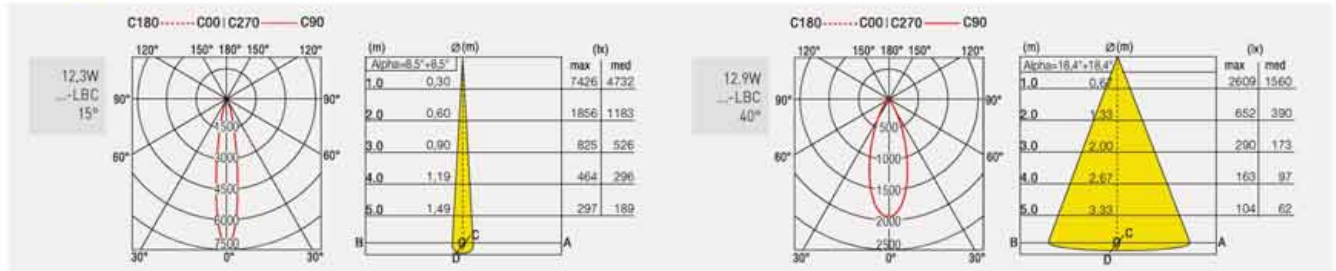

ALIMENTATORI-KIT RGB (se non in dotazione) da ordinare dalla sezione arancio - DRIVERS-RGB KITS (when not supplied) to be ordered from the section orange color



- Corpo in pressofusione di alluminio, verniciato in polveri con pretrattamento speciale per esterni.
- Anello di finitura in acciaio Inox (AISI 316).
- Pressacavo in ottone nichelato PG13,5.
- Vetro temperato di spessore 10 mm.
- Body in die-cast aluminium with special powder treatment for outdoor use.
- Stainless steel (AISI 316) frame.
- PG13,5 nickel brass cable gland.
- Tempered glass 10 mm thick.

OLODUM FLAT MIDI TONDO/COB

LED COB



		LED							SISTEMA-SYSTEM					
		W	lm	V	K	CRI	T	W	lm	lm/W				
	E8251-T-RGB	5x3,6W	-	350mA		-	55°	-	-	-				
LED COB														
LUCE SIMMETRICA - SYMMETRIC LIGHT														
	E8276T-LBC-S	SPOT												
Inox	E8276T-LBC-FL	FLOOD		8,5W	950	220-240V [250mA]	3000	>90	45°	•	•	9,5W	780	82
	E8276T-LBC-WF	WIDE FLOOD											746	79
													780	80
	E8276T-LBN-S	SPOT											821	86
Inox	E8276T-LBN-FL	FLOOD		8,5W	1000	220-240V [250mA]	4000	>90	45°	•	•	9,5W	785	82
	E8276T-LBN-WF	WIDE FLOOD											800	84
LUCE ASIMMETRICA - ASYMMETRIC LIGHT														
	E8276T-LBC-AS												680	71
Inox	E8276T-LBN-AS			8,5W	1000	220-240V [250mA]	4000	>90	45°	•	•	9,5W	715	75

OP. ...TSC TORX Viti di sicurezza - Safety screws

ACC. **646308** Connettore IP68 Ø da 7 a 12mm - IP68 connector Ø from 7 to 12mm

E960 Ventosa per rimuovere vetro - Glass remover



*In fase di approvazione - Under approval

IK 10
IP 67



Velocità max carrabilità 20 km-h
Drive-over max speed 20 km-h

Carico statico 2000 kg
Static load 2000 kg



outside

ALIMENTATORI-KIT RGB (se non in dotazione) da ordinare dalla sezione arancio - DRIVERS-RGB KITS (when not supplied) to be ordered from the section orange color



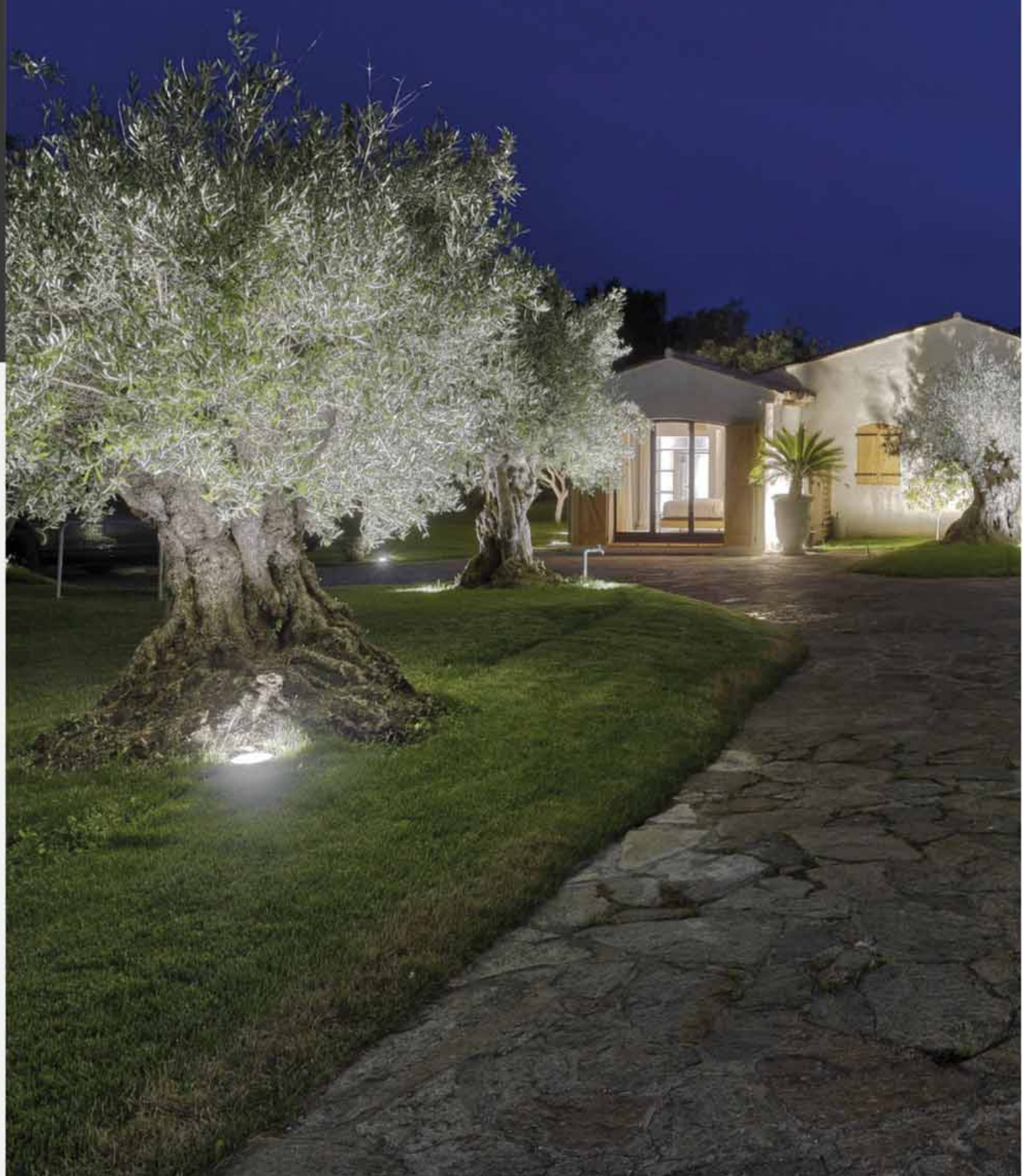



OLODUM MIDI TONDO COB PROOF SHORT



- Corpo in materiale polimerico.
 - Alta resistenza ambiente marino o ad alta salinità.
 - Anello di finitura in acciaio Inox (AISI 316L).
 - Pressacavo in ottone nichelato PG7.
 - Vetro temperato di spessore 10 mm.
- Body in polymeric material.
 - High resistance to marine and heavy salt environments.
 - Stainless steel (AISI 316L) frame.
 - PG7 cable gland of nickel plated brass.
 - Tempered glass 10 mm thick.

LED COB	Icona	LED	SISTEMA-SYSTEM										
			W	lm	V	K	(CRI)	T	Icona	W	lm	W	
LUCE SIMMETRICA - SYMMETRIC LIGHT													
Inox	E8272-LBC-S	SPOT	8,5W	950	220-240V [250mA]	3000	>90	45°	•	•	9,5W	780	82
	E8272-LBC-FL	FLOOD									9,5W	746	79
	E8272-LBC-WF	WIDE FLOOD									9,5W	760	80
LUCE ASIMMETRICA - ASYMMETRIC LIGHT													
Inox	E8272-LBN-S	SPOT	8,5W	1000	220-240V [250mA]	4000	>90	45°	•	•	9,5W	821	86
	E8272-LBN-FL	FLOOD									9,5W	785	82
	E8272-LBN-WF	WIDE FLOOD									9,5W	800	84
	E8272-LBC-AS		8,5W	950	220-240V [250mA]	3000	>90	45°	•	•	9,5W	680	71
	E8272-LBN-AS										9,5W	715	75

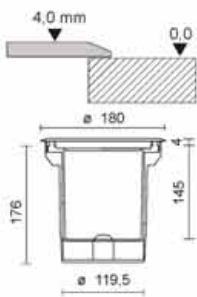

1Kg
3,40

OP. TSC TORX Viti di sicurezza - Safety screws

ACC. **646308** Connettore IP68 ø da 7 a 12mm - IP68 connector ø from 7 to 12mm
E960 Ventosa per rimuovere vetro - Glass remover

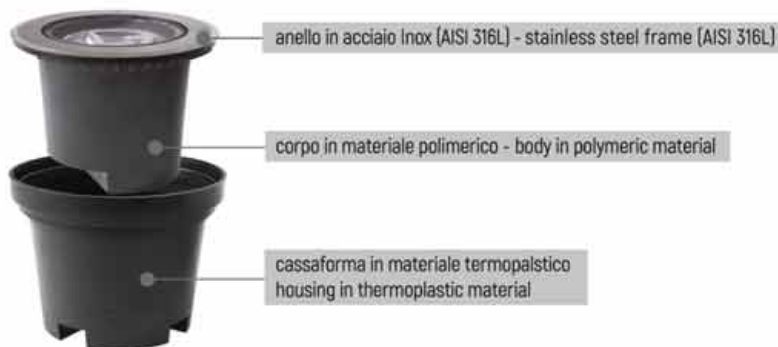

NUOVO MATERIALE TERMOPLASTICO SUPER RESISTENTE
NEW THERMOPLASTIC MATERIAL SUPER RESISTANT



IK 10
IP 67



Velocità max carrabilità 20 km/h
 Drive-over max speed 20 km/h

Carico statico 2000 kg
 Static load 2000 kg

outside

ALIMENTATORI-KIT RGB (se non in dotazione) da ordinare dalla sezione arancio - DRIVERS-RGB KITS (when not supplied) to be ordered from the section orange color



OLODUM MIDI TONDO FLAT COB PROOF SHORT

- Corpo in materiale polimerico.
- Alta resistenza ambiente marino o ad alta salinità.
- Anello di finitura in acciaio Inox (AISI 316L).
- Pressacavo in ottone nichelato PG7.
- Vetro temperato di spessore 10 mm.

- Body in polymeric material.
- High resistance to marine and heavy salt environments.
- Stainless steel (AISI 316L) frame.
- PG7 cable gland of nickel plated brass.
- Tempered glass 10 mm thick.



LED COB		LED							SISTEMA-SYSTEM						
		W	lm	V	K	CRI	T	W	lm	lm					
	LUCE SIMMETRICA - SYMMETRIC LIGHT														
	Inox	E8277T-LBC-S	SPOT	▲▲	8,5W	950	220-240V [250mA]	3000	>90	45°	•	•	9,5W	780	82
		E8277T-LBC-FL	FLOOD	▲▲▲										746	79
		E8277T-LBC-WF	WIDE FLOOD	▲▲▲▲										760	80
		E8277T-LBN-S	SPOT	▲▲										821	86
		E8277T-LBN-FL	FLOOD	▲▲▲										785	82
	Inox	E8277T-LBN-WF	WIDE FLOOD	▲▲▲▲	8,5W	1000	220-240V [250mA]	4000	>90	45°	•	•	9,5W	800	84
	LUCE ASIMMETRICA - ASYMMETRIC LIGHT														
	Inox	E8277T-LBC-AS		▲	8,5W	950	220-240V [250mA]	3000	>90	45°	•	•	9,5W	680	71
		E8277T-LBN-AS		▲									715	75	

OP. -TSC TORX Viti di sicurezza - Safety screws

ACC. **646308** Connettore IP68 ø da 7 a 12mm - IP68 connector ø from 7 to 12mm
E960 Ventosa per rimuovere vetro - Glass remover

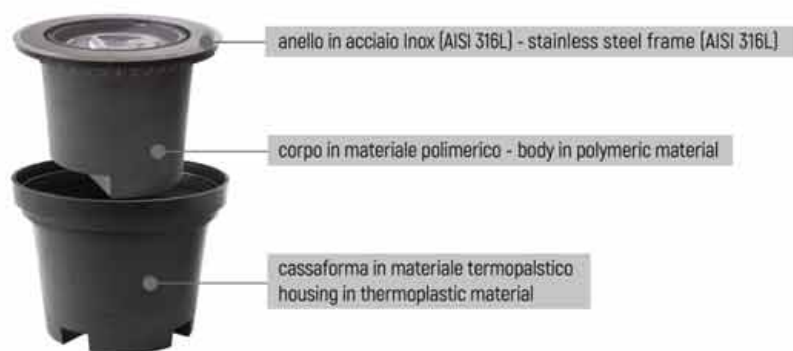

NUOVO MATERIALE TERMOPLASTICO SUPER RESISTENTE
NEW THERMOPLASTIC MATERIAL SUPER RESISTANT



Velocità max carrabilità 20 km/h
 Drive-over max speed 20 km/h

Carico statico 2000 kg
 Static load 2000 kg



outside

ALIMENTATORI-KIT RGB (se non in dotazione) da ordinare dalla sezione arancio - DRIVERS-RGB KITS (when not supplied) to be ordered from the section orange color



OLODUM MIDI QUADRO FLAT COB PROOF SHORT



- Corpo in materiale polimerico.
 - Alta resistenza ambiente marino o ad alta salinità.
 - Anello di finitura in acciaio Inox (AISI 316L).
 - Pressacavo in ottone nichelato PG7.
 - Vetro temperato di spessore 10 mm.
- Body in polymeric material.
 - High resistance to marine and heavy salt environments.
 - Stainless steel (AISI 316L) frame.
 - PG7 cable gland of nickel plated brass.
 - Tempered glass 10 mm thick.

LED COB	SYGL 340	SYGL 340	LED							SISTEMA-SYSTEM			
			W	lm	V	K	CRI	T	IP	W	lm	IP	
LUCE SIMMETRICA - SYMMETRIC LIGHT													
Inox	E8277-LBC-S	SPOT	8,5W	950	220-240V [250mA]	3000	>90	45°	•	•	9,5W	780	82
	E8277-LBC-FL	FLOOD									746	79	
	E8277-LBC-WF	WIDE FLOOD									760	80	
LUCE ASIMMETRICA - ASYMMETRIC LIGHT													
Inox	E8277-LBN-S	SPOT	8,5W	1000	220-240V [250mA]	4000	>90	45°	•	•	9,5W	821	86
	E8277-LBN-FL	FLOOD									785	82	
	E8277-LBN-WF	WIDE FLOOD									800	84	
Inox	E8277-LBC-AS		8,5W	950	220-240V [250mA]	3000	>90	45°	•	•	9,5W	680	71
	E8277-LBN-AS			1000		4000					715	75	

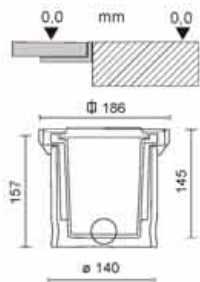

OP. 3000000000 TSC TORX Viti di sicurezza - Safety screws

ACC. 646308 Connettore IP68 ø da 7 a 12mm - IP68 connector ø from 7 to 12mm
E960 Ventosa per rimuovere vetro - Glass remover

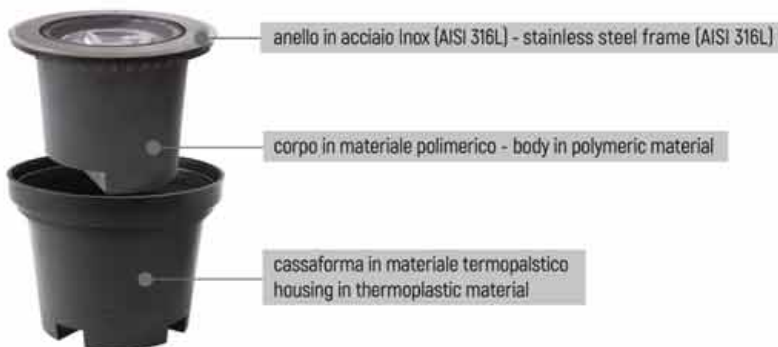

**NUOVO MATERIALE TERMOPLASTICO SUPER RESISTENTE
NEW THERMOPLASTIC MATERIAL SUPER RESISTANT**



IK 10
IP 67



Velocità max carrabilità 20 km/h
Drive-over max speed 20 km/h

Carico statico 2000 kg
Static load 2000 kg

outside

ALIMENTATORI-KIT RGB (se non in dotazione) da ordinare dalla sezione arancio - DRIVERS-RGB KITS (when not supplied) to be ordered from the section orange color





- Corpo in pressofusione di alluminio, verniciato in polveri con pretrattamento speciale per esterni.
- Anello di finitura in acciaio Inox (AISI 316).
- Pressacavo in ottone nichelato PG13,5.
- Vetro temperato di spessore 10 mm.
- Body in die-cast aluminium with special powder treatment for outdoor use.
- Stainless steel (AISI 316) frame.
- PG13,5 nickel brass cable gland.
- Tempered glass 10 mm thick.

OLODUM STANDARD TONDO COB

LED COB

ASIMMETRICO/ASYMMETRIC



LED COB	LED	SISTEMA-SYSTEM												
		W	lm	V	K	CRI	T	W	lm	lm/W				
	LUCE SIMMETRICA - SYMMETRIC LIGHT													
	Inbox	E8128-LBC-S	SPOT	18	17W	2500	220-240V (500mA)	3000	>90	45°	•	•	2213	110
	Inbox	E8128-LBC-FL	FLOOD	40	17W	2665	220-240V (500mA)	4000	>90	45°	•	•	2195	109
		E8128-LBC-WF	WIDE FLOOD	60	17W	2665	220-240V (500mA)	4000	>90	45°	•	•	1990	99
	LUCE ASIMMETRICA - ASYMMETRIC LIGHT													
	Inbox	E8128-LBN-S	SPOT	18	17W	2550	220-240V (500mA)	3000	>90	45°	•	•	2360	118
	Inbox	E8128-LBN-FL	FLOOD	40	17W	2665	220-240V (500mA)	4000	>90	45°	•	•	2120	117
		E8128-LBN-WF	WIDE FLOOD	60	17W	2665	220-240V (500mA)	4000	>90	45°	•	•	2341	106
		E8128-LBN-AS	AS	18	17W	2550	220-240V (500mA)	3000	>90	45°	•	•	1880	94
		E8128-LBN-AS	AS	18	17W	2665	220-240V (500mA)	4000	>90	45°	•	•	2005	100



MODULO LED BASCULANTE ±15°
LED MODULE ADJUSTABLE ±15°

OP. -TSC TORX Viti di sicurezza - Safety screws

A richiesta - On request: disponibile - available

ACC. **646308** Connettore IP68 Ø da 7 a 12mm - IP68 connector Ø from 7 to 12mm

E960 Ventosa per rimuovere vetro - Glass remover

IK 10
IP 67

Velocità max carrabilità 20 km/h
Drive-over max speed 20 km/h

Carico statico 2000 kg
Static load 2000 kg

outside

ALIMENTATORI-KIT RGB (se non in dotazione) da ordinare dalla sezione arancio - DRIVERS-RGB KITS (when not supplied) to be ordered from the section orange color





- Corpo in pressofusione di alluminio, verniciato in polveri con pretrattamento speciale per esterni.
- Anello di finitura in acciaio Inox (AISI 316).
- Pressacavo in ottone nichelato PG13,5.
- Vetro temperato di spessore 10 mm.
- Body in with special powder die-cast aluminium treatment for outdoor use.
- Stainless steel (AISI 316) frame.
- PG13,5 nickel brass cable gland.
- Tempered glass 10 mm thick.

OLODUM FLAT STANDARD TONDO COB



LED COB	Icone	LUCE SIMMETRICA - SYMMETRIC LIGHT	LED						SISTEMA-SYSTEM				
			W	lm	V	K	CRI	T	W	lm	lm		
		LUCE SIMMETRICA - SYMMETRIC LIGHT											
		Inox E8131T-LBC-S SPOT	17W	2500	220-240V (500mA)	3000	>90	45°	•	•	20W	2213	110
		Inox E8131T-LBC-FL FLOOD	17W	2665	220-240V (500mA)	4000	>90	45°	•	•	20W	2195	109
		Inox E8131T-LBC-WF WIDE FLOOD	17W	2665	220-240V (500mA)	4000	>90	45°	•	•	20W	1990	99
		Inox E8131T-LBN-S SPOT	17W	2500	220-240V (500mA)	3000	>90	45°	•	•	20W	2380	118
		Inox E8131T-LBN-FL FLOOD	17W	2665	220-240V (500mA)	4000	>90	45°	•	•	20W	2120	117
		LUCE ASIMMETRICA - ASYMMETRIC LIGHT											
		Inox E8131T-LBC-AS	17W	2500	220-240V (500mA)	3000	>90	45°	•	•	20W	1880	94
		Inox E8131T-LBN-AS	17W	2665	220-240V (500mA)	4000	>90	45°	•	•	20W	2005	100



OP. ...TSC TORX Viti di sicurezza - Safety screws

A richiesta - On request: disponibile - available



ACC. **646308** Connettore IP68 ø da 7 a 12mm - IP68 connector ø from 7 to 12mm

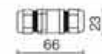

E960 Ventosa per rimuovere vetro - Glass remover

IK 10
IP 67



Velocità max carrabilità 20 km/h
Drive-over max speed 20 km/h

Carico statico 2000 kg
Static load 2000 kg

outside

ALIMENTATORI-KIT RGB (se non in dotazione) da ordinare dalla sezione arancio - DRIVERS-RGB KITS (when not supplied) to be ordered from the section orange color



*In fase di approvazione - Under approval

													Velocità max carrabilità 5 km-h Drive-over max speed 5 km-h Carico statico 1000 kg Static load 1000 kg	
--	--	--	--	--	--	--	--	--	--	--	--	--	---	--

ALIMENTATORI-KIT RGB (se non in dotazione) da ordinare dalla sezione arancio - DRIVERS-RGB KITS (when not supplied) to be ordered from the section orange color



OLODUM STANDARD PROOF TONDO COB

- Corpo in materiale polimerico.
- Alta resistenza ambiente marino o ad alta salinità.
- Anello di finitura in acciaio Inox (AISI 316L).
- Pressacavo in ottone nichelato PG13.5.
- Vetro temperato di spessore 10 mm.
- Body in polymeric material.
- High resistance to marine and heavy salt environments.
- Stainless steel (AISI 316L) frame.
- PG13.5 cable gland of nickel plated brass.
- Tempered glass 10 mm thick.



LED COB	Icon	LED							SISTEMA-SYSTEM					
		W	lm	V	K	CRI	T	Icon	W	lm	Icon			
	LUCE SIMMETRICA - SYMMETRIC LIGHT Inox													
	E8129-LBC-S	SPOT	17W	2500	220-240V (500mA)	3000	>90	45°	•	•	20W	2213	110	
	E8129-LBC-FL	FLOOD										2195	109	
	E8129-LBC-WF	WIDE FLOOD										1990	99	
	E8129-LBN-S	SPOT	17W	2665	220-240V (500mA)	4000	>90	45°	•	•	20W	2360	118	
	E8129-LBN-FL	FLOOD										2120	117	
E8129-LBN-WF	WIDE FLOOD										2341	106		
LUCE ASIMMETRICA - ASYMMETRIC LIGHT Inox														
E8129-LBC-AS		17W	2500	220-240V (500mA)	3000	>90	45°	•	•	20W	1880	94		
E8129-LBN-AS			2665		4000						2005	100		

LED COB	Icon	LED							SISTEMA-SYSTEM					
		W	lm	V	K	CRI	T	Icon	W	lm	Icon			
	LUCE SIMMETRICA - SYMMETRIC LIGHT Inox													
	E8132T-LBC-S	SPOT	17W	2500	220-240V (500mA)	3000	>90	45°	•	•	20W	2213	110	
	E8132T-LBC-FL	FLOOD										2195	109	
	E8132T-LBC-WF	WIDE FLOOD										1990	99	
	E8132T-LBN-S	SPOT	17W	2665	220-240V (500mA)	4000	>90	45°	•	•	20W	2360	118	
	E8132T-LBN-FL	FLOOD										2120	117	
E8132T-LBN-WF	WIDE FLOOD										2341	106		
LUCE ASIMMETRICA - ASYMMETRIC LIGHT Inox														
E8132T-LBC-AS		17W	2500	220-240V (500mA)	3000	>90	45°	•	•	20W	1880	94		
E8132T-LBN-AS			2665		4000						2005	100		

OP. TSC TORX Viti di sicurezza - Safety screws

A richiesta - On request: disponibile - available

ACC. 646308 Connettore IP68 ø da 7 a 12mm - IP68 connector ø from 7 to 12mm

E960 Ventosa per rimuovere vetro - Glass remover



NUOVO MATERIALE TERMOPLASTICO SUPER RESISTENTE
NEW THERMOPLASTIC MATERIAL SUPER RESISTANT





OLODUM STANDARD QUADRO

- Corpo in pressofusione di alluminio, verniciato in polveri con pretrattamento speciale per esterni.
- Anello di finitura in acciaio Inox (AISI 316).
- Pressacavo in ottone nichelato PG13,5.
- Vetro temperato di spessore 10 mm.

- Body with special powder die-cast aluminium treatment for outdoor use.
- Stainless steel (AISI 316) frame.
- PG13,5 nickel brass cable gland.
- Tempered glass, 10 mm thick.



	LED	SISTEMA-SYSTEM										
		W	lm	W	lm							
 	 E7070-LBC E7070-LBN	24,9W	3700 4025	220-240V (750mA)	3000 4000	>90	50°	•	•	27,5W	3071 3340	111 121

DP. -TSC TORX Viti di sicurezza - Safety screws

ACC. **646308** Connettore IP68 Ø da 7 a 12mm - IP68 connector Ø from 7 to 12mm
E960 Ventosa per rimuovere vetro - Glass remover



IK 10
IP 67



Velocità max carrabilità 20 km-h
 Drive-over max speed 20 km-h

Carico statico 2000 kg
 Static load 2000 kg

ALIMENTATORI-KIT RGB (se non in dotazione) da ordinare dalla sezione arancio - DRIVERS-RGB KITS (when not supplied) to be ordered from the section orange color

outside

OLODUM STANDARD PROOF QUADRO COB



- Corpo in materiale termoplastico.
- Alta resistenza ambiente marino o ad alta salinità.
- Anello di finitura in acciaio Inox (AISI 316L).
- Pressacavo in ottone nichelato PG13,5.
- Vetro temperato di spessore 10 mm.
- Body in thermoplastic material.
- High resistance to marine and heavy salt environments.
- Stainless steel (AISI 316L) frame.
- PG13,5 cable gland of nickel plated brass.
- Tempered glass, 10 mm thick.



LED COB	LED	LED							SISTEMA SYSTEM				
		W	lm	V	K	CRI	T	W	lm	W			
LUCE SIMMETRICA - SYMMETRIC LIGHT													
Inox	E8132-LBC-S	SPOT	18								2213	110	
Inox	E8132-LBC-FL	FLOOD	40	17W	2500	220-240V (500mA)	3000	>90	45°	• •	20W	2195	109
Inox	E8132-LBC-WF	WIDE FLOOD	60								1990	99	
LUCE ASIMMETRICA - ASYMMETRIC LIGHT													
Inox	E8132-LBN-S	SPOT	18								2360	118	
Inox	E8132-LBN-FL	FLOOD	40	17W	2665	220-240V (500mA)	4000	>90	45°	• •	20W	2120	117
Inox	E8132-LBN-WF	WIDE FLOOD	60								2341	106	
Inox	E8132-LBC-AS			17W	2500	220-240V (500mA)	3000	>90	45°	• •	20W	1880	94
Inox	E8132-LBN-AS				2665		4000				2005	100	

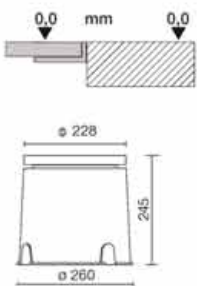

OP. ...TSC TORX Viti di sicurezza - Safety screws
A richiesta - On request: disponibile - available

ACC. **646308** Connettore IP68 ø da 7 a 12mm - IP68 connector ø from 7 to 12mm
E960 Ventosa per rimuovere vetro - Glass remover



NUOVO MATERIALE TERMOPLASTICO SUPER RESISTENTE
NEW THERMOPLASTIC MATERIAL SUPER RESISTANT

* In fase di approvazione - Under approval



Velocità max carrabilità 5 km-h
Drive-over max speed 5 km-h
Carico statico 1000 kg
Static load 1000 kg



ALIMENTATORI-KIT RGB (se non in dotazione) da ordinare dalla sezione arancio - DRIVERS-RGB KITS (when not supplied) to be ordered from the section orange color

INCASSI A TERRA • INGROUND



OLODUM MAXI TONDO COB

- Corpo in pressofusione di alluminio, verniciato in polveri con pretrattamento speciale per esterni.
- Anello di finitura in acciaio Inox (AISI 316).
- Pressacavo in ottone nichelato PG13,5.
- Vetro temperato di spessore 10 mm.
- Body in die-cast aluminium with special powder treatment for outdoor use.
- Stainless steel (AISI 316) frame.
- PG13,5 nickel brass cable gland.
- Tempered glass 10 mm thick.



LED COB	Icona	LED	SISTEMA-SYSTEM													
			W	lm	V	K	CRI	T	W	lm	lm/W					
		OLODUM MAXI														
		Inox	E8340-LBC-S	SPOT	20	31W	4790	220-240V (900mA)	3000	>90	55°	•	•	35W	4240	121
			E8340-LBC-FL	FLOOD	40										4208	120
			E8340-LBC-WF	WIDE FLOOD	60										3805	109
		Inox	E8340-LBN-S	SPOT	20	31W	4900	220-240V (900mA)	4000	>90	55°	•	•	35W	4338	124
			E8340-LBN-FL	FLOOD	40										4305	123
			E8340-LBN-WF	WIDE FLOOD	60										3892	111
		DIMMER 1+10V														
		Inox	E8340-LBC-SD	SPOT	20	31W	4790	220-240V (900mA)	3000	>90	55°	•	•	35W	4240	121
			E8340-LBC-FLD	FLOOD	40										4208	120
			E8340-LBC-WFD	WIDE FLOOD	60										3805	109
		Inox	E8340-LBN-SD	SPOT	20	31W	4900	220-240V (900mA)	4000	>90	55°	•	•	35W	4338	124
			E8340-LBN-FLD	FLOOD	40										4305	123
			E8340-LBN-WFD	WIDE FLOOD	60										3892	111
		DALI DIM-DALI/PUSH														
		Inox	E8340LBC-SDA	SPOT	20	31W	4790	220-240V (900mA)	3000	>90	55°	•	•	35W	4240	120
			E8340LBC-FLDA	FLOOD	40										4208	121
			E8340LBC-WFDA	WIDE FLOOD	60										3805	109
Inox	E8340LBN-SDA	SPOT	20	31W	4900	220-240V (900mA)	4000	>90	55°	•	•	35W	4338	124		
	E8340LBN-FLDA	FLOOD	40										4305	123		
	E8340LBN-WFDA	WIDE FLOOD	60										3892	111		
OLODUM FLAT MAXI TONDO																
Inox	E8346-LBC-S	SPOT	20	31W	4790	220-240V (900mA)	3000	>90	55°	•	•	35W	4240	121		
	E8346-LBC-FL	FLOOD	40										4208	120		
	E8346-LBC-WF	WIDE FLOOD	60										3805	109		
Inox	E8346-LBN-S	SPOT	20	31W	4900	220-240V (900mA)	4000	>90	55°	•	•	35W	4338	124		
	E8346-LBN-FL	FLOOD	40										4305	123		
	E8346-LBN-WF	WIDE FLOOD	60										3892	111		
DIMMER 1+10V																
Inox	E8346-LBC-SD	SPOT	20	31W	4790	220-240V (900mA)	3000	>90	55°	•	•	35W	4240	121		
	E8346-LBC-FLD	FLOOD	40										4208	120		
	E8346-LBC-WFD	WIDE FLOOD	60										3805	109		
Inox	E8346-LBN-SD	SPOT	20	31W	4900	220-240V (900mA)	4000	>90	55°	•	•	35W	4338	124		
	E8346-LBN-FLD	FLOOD	40										4305	123		
	E8346-LBN-WFD	WIDE FLOOD	60										3892	111		
DALI DIM-DALI/PUSH																
Inox	E8346LBC-SDA	SPOT	20	31W	4790	220-240V (900mA)	3000	>90	55°	•	•	35W	4240	121		
	E8346LBC-FLDA	FLOOD	40										4208	120		
	E8346LBC-WFDA	WIDE FLOOD	60										3805	109		
Inox	E8346LBN-SDA	SPOT	20	31W	4900	220-240V (900mA)	4000	>90	55°	•	•	35W	4338	124		
	E8346LBN-FLDA	FLOOD	40										4305	123		
	E8346LBN-WFDA	WIDE FLOOD	60										3892	111		



Velocità max carrabilità 20 km/h
Drive-over max speed 20 km/h
Carico statico 2000 kg
Static load 2000 kg



OLODUM MAXI QUADRO COB



- Corpo in pressofusione di alluminio, verniciato in polveri con pretrattamento speciale per esterni.
- Anello di finitura in acciaio Inox (AISI 316).
- Pressacavo in ottone nichelato PG13,5.
- Vetro temperato di spessore 10 mm.
- Body in die-cast aluminium with special powder treatment for outdoor use.
- Stainless steel (AISI 316) frame.
- PG13,5 nickel brass cable gland.
- Tempered glass 10 mm thick.

FLAT

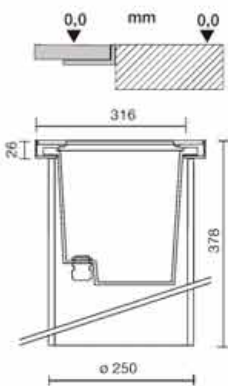

LED COB	Icona	Icona	LED							SISTEMA-SYSTEM				
			W	lm	V	K	CRI	T	Icona	W	lm	Icona		
OLODUM FLAT MAXI SQUARE														
Inox	E8345-LBC-S	SPOT	20									4240	121	
	E8345-LBC-FL	FLOOD	40	31W	4790	220-240V (900mA)	3000	>90	55°	•	•	35W	4208	120
	E8345-LBC-WF	WIDE FLOOD	60									3805	109	
Inox	E8345-LBN-S	SPOT	20									4338	124	
	E8345-LBN-FL	FLOOD	40	31W	4900	220-240V (900mA)	4000	>90	55°	•	•	35W	4305	123
	E8345-LBN-WF	WIDE FLOOD	60									3892	111	
DIMMER 1-10V														
Inox	E8345-LBC-SD	SPOT	20									4240	121	
	E8345-LBC-FLD	FLOOD	40	31W	4790	220-240V (900mA)	3000	>90	55°	•	•	35W	4208	120
	E8345-LBC-WFD	WIDE FLOOD	60									3805	109	
Inox	E8345-LBN-SD	SPOT	20									4338	124	
	E8345-LBN-FLD	FLOOD	40	31W	4900	220-240V (900mA)	4000	>90	55°	•	•	35W	4338	124
	E8345-LBN-WFD	WIDE FLOOD	60									3892	111	
DALI DIM-DALI/PUSH														
Inox	E8345LBC-SDA	SPOT	20									4240	121	
	E8345LBC-FLDA	FLOOD	40	31W	4790	220-240V (900mA)	3000	>90	55°	•	•	35W	4208	120
	E8345LBC-WFDA	WIDE FLOOD	60									3805	109	
Inox	E8345LBN-SDA	SPOT	20									4338	124	
	E8345LBN-FLDA	FLOOD	40	31W	4900	220-240V (900mA)	4000	>90	55°	•	•	35W	4305	123
	E8345LBN-WFDA	WIDE FLOOD	60									3892	111	

1Kg
9.00

OP. 800000...TSC TORX Viti di sicurezza - Safety screws

ACC. 646308 Connettore IP68 Ø da 7 a 12mm - IP68 connector Ø from 7 to 12mm

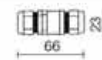

E960 Ventosa per rimuovere vetro - Glass remover

IK 10
IP 67

Velocità max carrabilità 20 km/h
Drive-over max speed 20 km/h
Carico statico 2000 kg
Static load 2000 kg

outside



ALIMENTATORI-KIT RGB (se non in dotazione) da ordinare dalla sezione arancio - DRIVERS-RGB KITS (when not supplied) to be ordered from the section orange color



OLODUM-RULED MIDI PROOF TONDO

- Corpo in materiale polimerico.
- Anello di finitura in acciaio Inox (AISI 316L).
- Alta resistenza ambiente marino o ad alta salinità.
- Pressacavo in poliammide PG7.
- Vetro temperato di spessore 10 mm.
- Completo di cassaforma.

- Body in polymeric material.
- Stainless steel (AISI 316L) frame.
- High resistance to marine and heavy salt environments.
- PG7 cable gland of polyamide.
- Tempered glass 10 mm thick.
- Housing included.



FLAT

	Inox	E8272-LBC-12 E8272-LBN-12	E8272-LBC-55 E8272-LBN-55	E8272-LBC-75 E8272-LBN-75	E8272-LBC-ASI E8272-LBN-ASI	E8272-LBC-AE E8272-LBN-AE	LED							SISTEMA-SYSTEM								
							W	lm	V	K	CRI	T	IP	W	lm	W/W						
								8,5W	1115 1180	220-240V [350mA]	3000 4000	>90	42°	•	•	9,5W	927	98	981	103		
versione - version FLAT 																						
								8,5W	1115 1180	220-240V [350mA]	3000 4000	>90	42°	•	•	9,5W	927	98	981	103		

OP. A richiesta - On request: TSC TORX Viti di sicurezza - Safety screws

Cavo di alimentazione con dispositivo anti-traspirazione acqua
Power cable with anti-transpiration device

ACC. **646308** Connettore IP68 ø da 7 a 12mm - IP68 connector ø from 7 to 12mm



646636 Connettore IP68 a "T" ø da 7 a 10mm per file continue
T-shaped IP68 connector to ø from 7 to 10mm for continuous line



NUOVO MATERIALE TERMOPLASTICO SUPER RESISTENTE
NEW THERMOPLASTIC MATERIAL SUPER RESISTANT



Velocità max carrabilità 20 km/h
Drive-over max speed 20 km/h

Carico statico 2000 kg
Static load 2000 kg

outside

IK 10
IP 67



5 ANNI

ALIMENTATORI-KIT RGB (se non in dotazione) da ordinare dalla sezione arancio - DRIVERS-RGB KITS (when not supplied) to be ordered from the section orange color



OLODUM-RULED MIDI PROOF QUADRO

- Corpo in materiale polimerico.
- Anello di finitura in acciaio Inox (AISI 316L).
- Alta resistenza ambiente marino o ad alta salinità.
- Pressacavo in poliammide PG7.
- Vetro temperato di spessore 10 mm.
- Completo di cassaforma.

- Body in polymeric material.
- Stainless steel (AISI 316L) frame.
- High resistance to marine and heavy salt environments.
- PG7 cable gland of polyamide.
- Tempered glass 10 mm thick.
- Housing included.



versione - version FLAT	Inox	E8277F-LBC-12 E8277F-LBN-12	⚠	LED							SISTEMA-SYSTEM		
				W	lm	V	K	CRI	T	☞	W	lm	lm/W
	Inox	E8277F-LBC-12	⚠	8,5W	1115	220-240V (350mA)	3000	>90	42°	•	•	942	99
		E8277F-LBN-12					4000					997	105
	Inox	E8277F-LBC-55	⚠	8,5W	1115	220-240V (350mA)	3000	>90	42°	•	•	821	86
		E8277F-LBN-55					4000					869	91
	Inox	E8277F-LBC-75	⚠	8,5W	1180	220-240V (350mA)	3000	>90	42°	•	•	927	98
		E8277F-LBN-75					4000					981	103
	Inox	E8277F-LBC-ASI	⚠	8,5W	1115	220-240V (350mA)	3000	>90	42°	•	•	914	96
		E8277F-LBN-ASI					4000					967	102
	Inox	E8277F-LBC-AE	⚠	8,5W	1115	220-240V (350mA)	3000	>90	42°	•	•	618	65
		E8277F-LBN-AE					4000					655	69

OP. A richiesta - On request: TSC TORX Viti di sicurezza - Safety screws

Cavo di alimentazione con dispositivo anti-traspirazione acqua
Power cable with anti-transpiration device

ACC. 646308 Connettore IP68 ø da 7 a 12mm - IP68 connector ø from 7 to 12mm

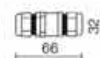

646636 Connettore IP68 a "T" ø da 7 a 10mm per file continue
T-shaped IP68 connector to ø from 7 to 10mm for continuous line

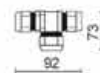

NUOVO MATERIALE TERMOPLASTICO SUPER RESISTENTE
NEW THERMOPLASTIC MATERIAL SUPER RESISTANT



Velocità max carrabilità 20 km-h
Drive-over max speed 20 km-h

Carico statico 2000 kg
Static load 2000 kg

outside



ALIMENTATORI-KIT RGB (se non in dotazione) da ordinare dalla sezione arancio - DRIVERS-RGB KITS (when not supplied) to be ordered from the section orange color



OLODUM-RULED STANDARD PROOF TONDO

- Corpo in materiale polimerico.
- Anello di finitura in acciaio Inox [AISI 316L].
- Alta resistenza ambiente marino o ad alta salinità.
- Pressacavo in ottone nichelato PG13,5.
- Vetro temperato di spessore 10 mm.
- Completo di cassaforma.

- Body in polymeric material.
- Stainless steel [AISI 316L] frame.
- High resistance to marine and heavy salt environments.
- PG13,5 cable gland of nickel plated brass.
- Tempered glass 10 mm thick.
- Housing included.



	Inox	E8129-LBC-12 E8129-LBN-12	E8129-LBC-55 E8129-LBN-55	E8129-LBC-75 E8129-LBN-75	E8129-LBC-ASI E8129-LBN-ASI	E8129-LBC-AE E8129-LBN-AE	LED							SISTEMA-SYSTEM													
							W	lm	V	K	CRI	T	IP	W	lm	W											
versione - version FLAT 																											

OP. A richiesta - On request: -TSC TORX Viti di sicurezza - Safety screws

Cavo di alimentazione con dispositivo anti-traspirazione acqua
Power cable with anti-transpiration device

ACC. **646308** Connettore IP68 ø da 7 a 12mm - IP68 connector ø from 7 to 12mm



646636 Connettore IP68 a "T" ø da 7 a 10mm per file continue
T-shaped IP68 connector to ø from 7 to 10mm for continuous line

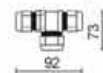

NUOVO MATERIALE TERMOPLASTICO SUPER RESISTENTE
NEW THERMOPLASTIC MATERIAL SUPER RESISTANT



Velocità max carrabilità 20 km-h
Drive-over max speed 20 km-h

Carico statico 2000 kg
Static load 2000 kg

outside

IK 10
IP 67



ALIMENTATORI-KIT RGB (se non in dotazione) da ordinare dalla sezione arancio - DRIVERS-RGB KITS (when not supplied) to be ordered from the section orange color



- Corpo in materiale polimerico.
- Anello di finitura in acciaio Inox (AISI 316L).
- Alta resistenza ambiente marino o ad alta salinità.
- Pressacavo in ottone nichelato PG13,5.
- Vetro temperato di spessore 10 mm.
- Completo di cassaforma.

- Body in polymeric material.
- Stainless steel (AISI 316L) frame.
- High resistance to marine and heavy salt environments.
- PG13,5 cable gland of nickel plated brass.
- Tempered glass 10 mm thick.
- Housing included.

OLODUM-RULED STANDARD PROOF QUADRO

FLAT



versione - version FLAT	Material	Model	LED							SISTEMA-SYSTEM			
			W	lm	V	K	CRI	T	Beam	W	lm	W	
E8132F-LBC-12 E8132F-LBN-12	Inox	E8132F-LBC-12 E8132F-LBN-12	17W	2226	220-240V (700mA)	3000	4000	>90	46°	• •	20W	1884	94
												1993	100
E8132F-LBC-55 E8132F-LBN-55	Inox	E8132F-LBC-55 E8132F-LBN-55	17W	2226	220-240V (700mA)	3000	4000	>90	46°	• •	20W	1641	82
												1737	87
E8132F-LBC-75 E8132F-LBN-75	Inox	E8132F-LBC-75 E8132F-LBN-75	17W	2355	220-240V (700mA)	3000	4000	>90	46°	• •	20W	1854	93
												1962	98
E8132F-LBC-ASI E8132F-LBN-ASI	Inox	E8132F-LBC-ASI E8132F-LBN-ASI	17W	2355	220-240V (700mA)	3000	4000	>90	46°	• •	20W	1827	91
												1933	97
E8132F-LBC-AE E8132F-LBN-AE	Inox	E8132F-LBC-AE E8132F-LBN-AE	17W	2355	220-240V (700mA)	3000	4000	>90	46°	• •	20W	1230	62
												1302	65

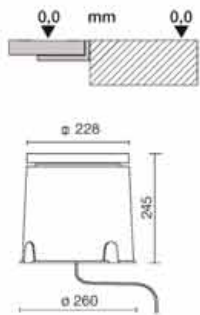

DP. A richiesta - On request. ...TSC TORX Viti di sicurezza - Safety screws

Cavo di alimentazione con dispositivo anti-traspirazione acqua
Power cable with anti-transpiration device

ACC. 646308 Connettore IP68 ø da 7 a 12mm - IP68 connector ø from 7 to 12mm



646636 Connettore IP68 a "T" ø da 7 a 10mm per file continue
T-shaped IP68 connector to ø from 7 to 10mm for continuous line



NUOVO MATERIALE TERMOPLASTICO SUPER RESISTENTE
NEW THERMOPLASTIC MATERIAL SUPER RESISTANT



Velocità max carrabilità 20 km/h
Drive-over max speed 20 km-h
Carico statico 2000 kg
Static load 2000 kg

outside

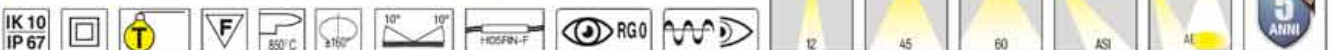

ALIMENTATORI-KIT RGB (se non in dotazione) da ordinare dalla sezione arancio - DRIVERS-RGB KITS (when not supplied) to be ordered from the section orange color



OLODUM-RULED MAXI TONDO

- Corpo in pressofusione di alluminio verniciato.
- Verniciatura di polveri di poliestere con trattamento speciale per esterni.
- Anello di finitura in acciaio Inox (AISI 316L).
- Pressacavo in ottone nichelato PG13,5.
- Vetro temperato di spessore 10 mm.
- Completo di cassaforma.

- Body made in die-cast aluminium.
- Polyester powder painting with special treatment for outdoors.
- Stainless steel (AISI 316L) frame.
- PG13,5 cable gland of nickel plated brass.
- Tempered glass 10 mm thick.
- Housing included.



	Inox	E8340-LBC-12 E8340-LBN-12	▲	LED							SISTEMA-SYSTEM								
				W	lm	V	K	CRI	T	☑	W	lm	☑						
	Inox	E8340-LBC-12 E8340-LBN-12	▲																
	Inox	E8340-LBC-55 E8340-LBN-55	▲																
		Inox	E8340-LBC-75 E8340-LBN-75	▲	31W	3840 4000	220-240V (1200mA)	3000 4000	>90	42°	•	•	34W	3332 3470	98 102				
	Inox	E8340-LBC-ASI E8340-LBN-ASI	▲																
	Inox	E8340-LBC-AE E8340-LBN-AE	▲																
		Inox	E8340F-LBC-12 E8340F-LBN-12	▲															
versione - version FLAT 	Inox	E8340F-LBC-12 E8340F-LBN-12	▲																
	Inox	E8340F-LBC-55 E8340F-LBN-55	▲																
		Inox	E8340F-LBC-75 E8340F-LBN-75	▲	31W	3840 4000	220-240V (1200mA)	3000 4000	>90	42°	•	•	34W	3332 3470	98 102				
	Inox	E8340F-LBC-ASI E8340F-LBN-ASI	▲																
	Inox	E8340F-LBC-AE E8340F-LBN-AE	▲																
		Inox	E8340F-LBC-12 E8340F-LBN-12	▲															

OP. A richiesta - On request: -TSC TORX Viti di sicurezza - Safety screws
Cavo di alimentazione con dispositivo anti-traspirazione acqua
Power cable with anti-transpiration device

ACC. **646308** Connettore IP68 ø da 7 a 12mm - IP68 connector ø from 7 to 12mm

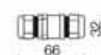

646636 Connettore IP68 a "T" ø da 7 a 10mm per file continue
T-shaped IP68 connector to ø from 7 to 10mm for continuous line

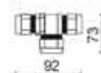

Velocità max carrabilità 20 km-h Drive-over max speed 20 km-h
Carico statico 2000 kg Static load 2000 kg

outside



ALIMENTATORI-KIT RGB (se non in dotazione) da ordinare dalla sezione arancio - DRIVERS-RGB KITS (when not supplied) to be ordered from the section orange color

OLODUM-RULED MAXI QUADRO

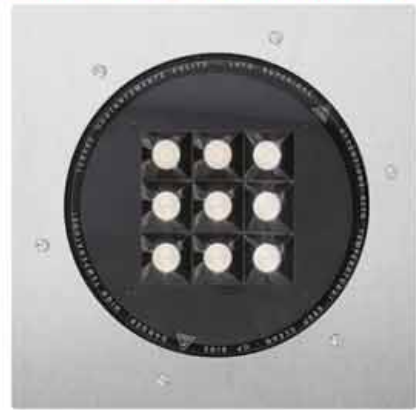

FLAT



- Corpo in pressofusione di alluminio verniciato.
 - Verniciatura di polveri di poliestere con trattamento speciale per esterni.
 - Anello di finitura in acciaio Inox (AISI 316L).
 - Pressacavo in ottone nichelato PG13,5.
 - Vetro temperato di spessore 10 mm.
 - Completo di cassaforma.
- Body made in die-cast aluminium.
 - Polyester powder painting with special treatment for outdoors.
 - Stainless steel (AISI 316L) frame.
 - PG13,5 cable gland of nickel plated brass.
 - Tempered glass 10 mm thick.
 - Housing included.

Icone	Materiali	Modello	LED						SISTEMA-SYSTEM		
			W	lm	V	K	CRI	T	W	lm	W
Inox		E8345F-LBC-12				3000			3386	100	
		E8345F-LBN-12				4000			3526	104	
Inox		E8345F-LBC-55				3000			2950	87	
		E8345F-LBN-55				4000			3072	90	
Inox	8,70 kg	E8345F-LBC-75	31W	3840	220-240V	3000	+90	42"	34W	3332	98
		E8345F-LBN-75		4000	(1200mA)	4000				3470	102
Inox		E8345F-LBC-ASI				3000				3282	97
		E8345F-LBN-ASI				4000				3420	101
Inox		E8345F-LBC-AE				3000				2223	65
		E8345F-LBN-AE				4000				2315	68

versione - version FLAT

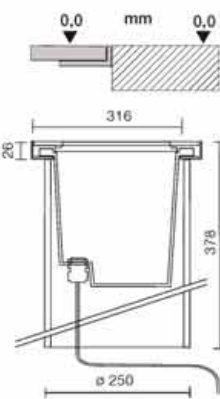

OP. A richiesta - On request: ...-TSC TORX Viti di sicurezza - Safety screws

Cavo di alimentazione con dispositivo anti-traspirazione acqua
Power cable with anti-transpiration device

ACC. 646308 Connettore IP68 ø da 7 a 12mm - IP68 connector ø from 7 to 12mm

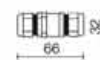

646536 Connettore IP68 a "T" ø da 7 a 10mm per file continue
T-shaped IP68 connector to ø from 7 to 10mm for continuous line

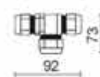

Velocità max carrabilità 20 km-h
Drive-over max speed 20 km-h

Carico statico 2000 kg
Static load 2000 kg

outside



ALIMENTATORI-KIT RGB (se non in dotazione) da ordinare dalla sezione arancio - DRIVERS-RGB KITS (when not supplied) to be ordered from the section orange color

LOCKsystem range

MAI PIÙ PROBLEMI DI CONDENSA
NO MORE CONDENSATION PROBLEMS

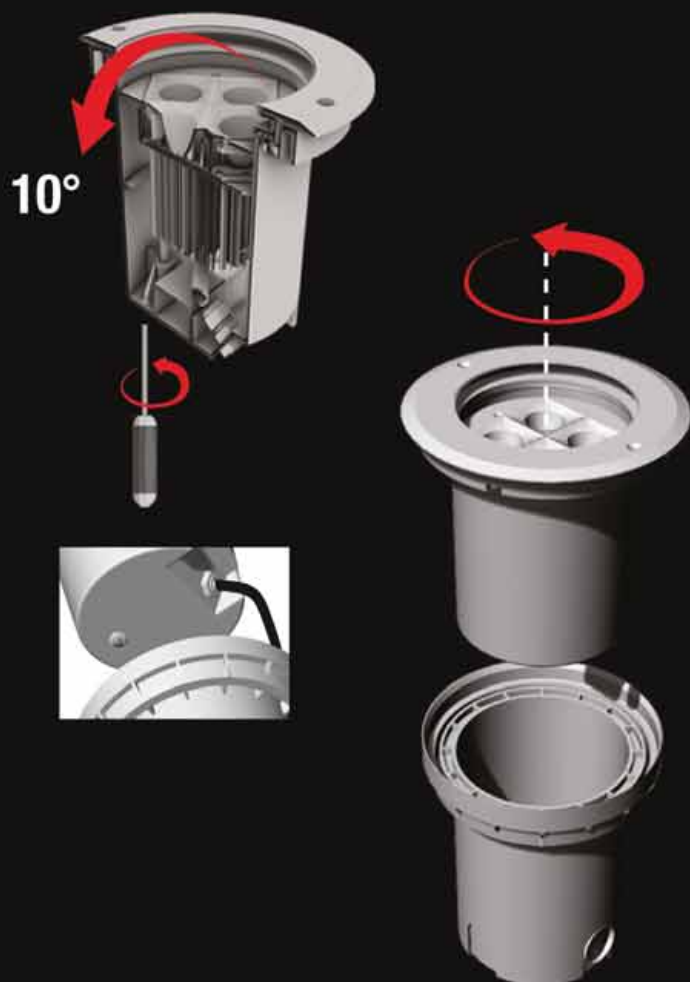

Il sistema LOCK applicato alla famiglia OLODUM permette di migliorare ulteriormente la tenuta stagna degli apparecchi.

Il corpo lampada, il gruppo sorgente-riflettore, il vetro di protezione e l'anello di chiusura esterno sono forniti in un'unica soluzione, chiusa a tenuta, non apribile.

In questo modo l'installazione dell'apparecchio avviene in due semplici passaggi. La posa del pozzetto a perdere e l'inserimento del corpo lampada nel pozzetto tramite due viti di fissaggio.

L'orientamento e la rotazione del vano ottico avvengono grazie ad un sistema di puntamento e rotazione, che non prevedono l'apertura dell'apparecchio.

Sarà pertanto possibile calibrare il fascio luminoso, anche ripetutamente, garantendo la tenuta stagna dell'intero corpo illuminante, fino a fine vita.

LOCK SYSTEM è disponibile sia nella versione RULED che in quella COB.

Non adatto per installazioni ad immersione.

The LOCK system applied to OLODUM family allows to further improve the watertightness of luminaires.

The lamp body, the source-reflector group, the protective glass and the external closing ring are supplied in a single, sealed, non-opening solution.

In this way, the installation of the device takes place in two simple steps. The installation of the disposable installation pit and the insertion of the lamp body into the pit using two fixing screws.

The orientation and rotation of the optical compartment take place thanks to a pointing and rotation system, which does not foresee any opening of the device.

It will therefore be possible to calibrate the light beam, even repeatedly, ensuring the watertight integrity of the entire lighting body, until the end of its life.

LOCK SYSTEM is available in both the RULED and COB versions.

Not for underground installation.

IK 10
IP 68

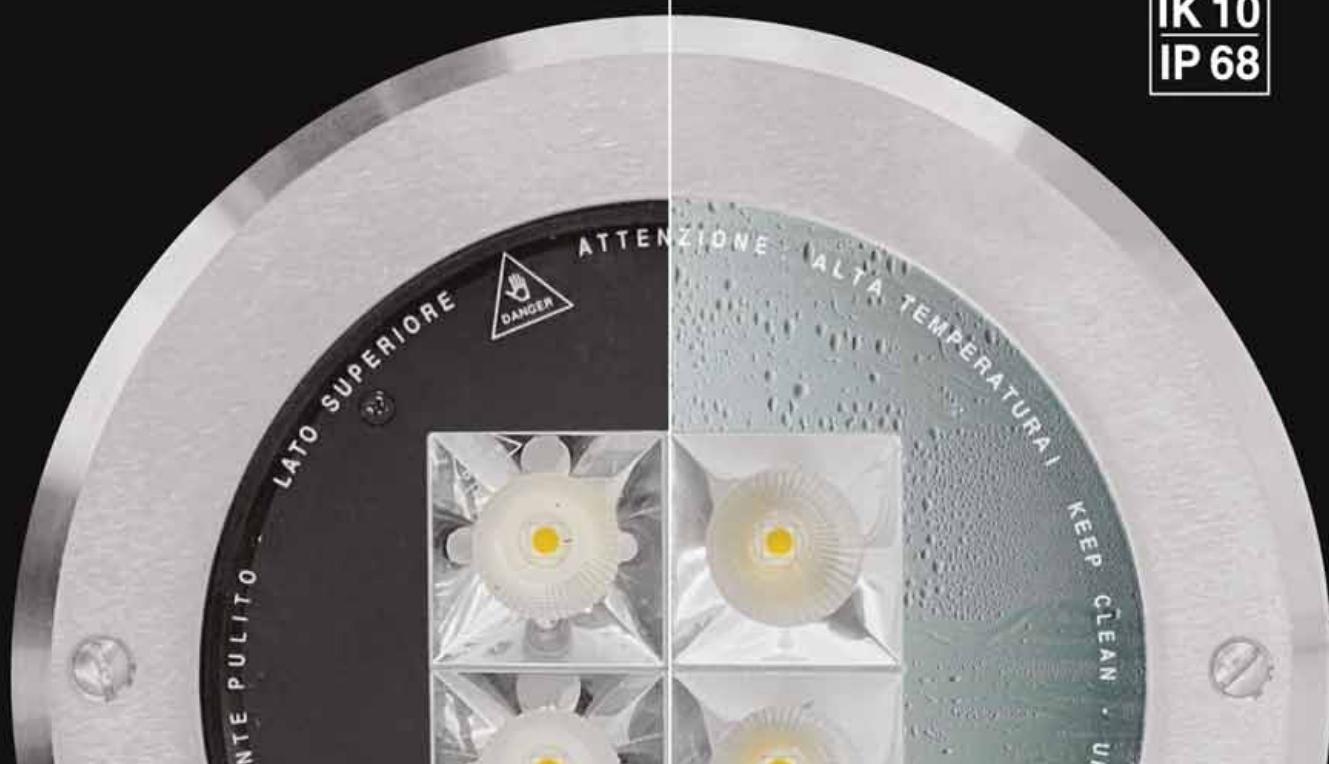

LOCKsystem range

OLODUM-RULED MIDI - STANDARD

DATI FOTOMETRICI - PHOTOMETRIC DATA

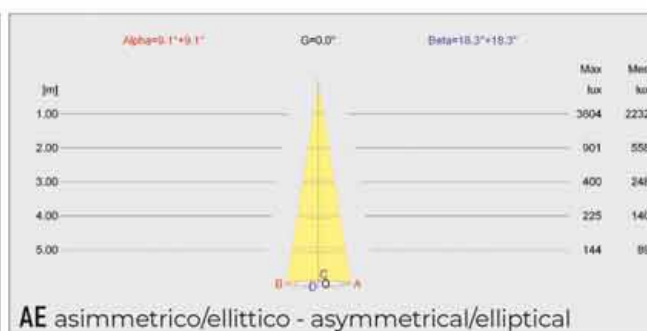
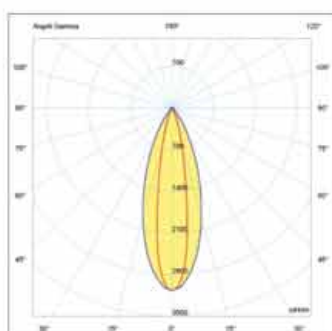
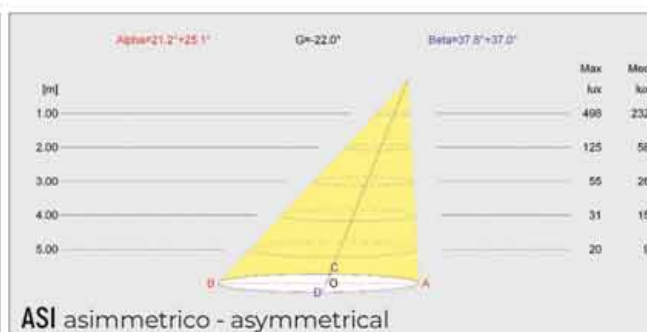
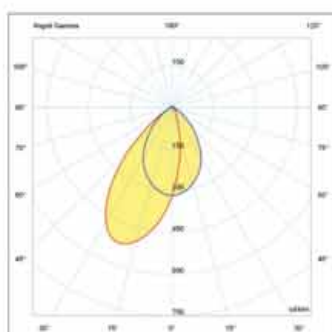
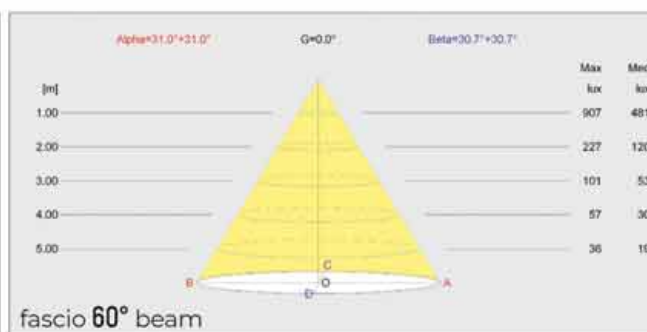
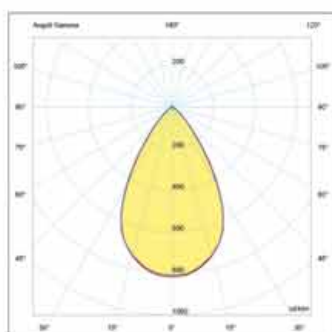
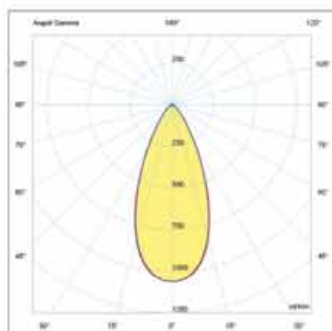
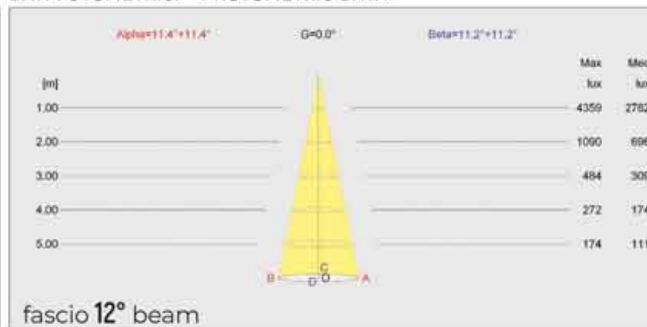
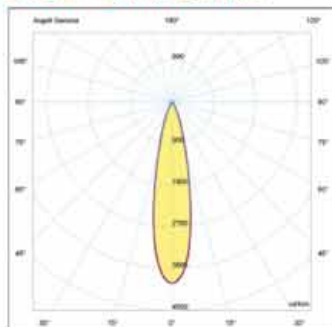

OLODUM-RULED STANDARD PROOF TONDO



- Corpo in materiale polimerico.
- Anello di finitura in acciaio Inox (AISI 316L).
- Alta resistenza ambiente marino o ad alta salinità.
- Pressacavo in ottone nichelato PG13,5.
- Vetro temperato di spessore 10 mm.
- Completo di cassaforma.

- Body in polymeric material.
- Stainless steel (AISI 316L) frame.
- High resistance to marine and heavy salt environments.
- PG13,5 cable gland of nickel plated brass.
- Tempered glass 10 mm thick.
- Housing included.



LOCKsystem	Material	Model	Icon	LED						SISTEMA-SYSTEM					
				W	lm	V	K	CRI	T	W	lm	W			
	Inox	E8129-LBC-12-ST	▲												
		E8129-LBN-12-ST												3000	1884
	Inox	E8129-LBC-55-ST	▲												
		E8129-LBN-55-ST												3000	1641
	Inox	E8129-LBC-75-ST	▲	Kg 2,60	17W	2226	220-240V	3000	>90	46°	•	•	20W	1854	93
		E8129-LBN-75-ST													
	Inox	E8129-LBC-ASI-ST	▲												
		E8129-LBN-ASI-ST													3000
	Inox	E8129-LBC-AE-ST	▲												
		E8129-LBN-AE-ST													3000

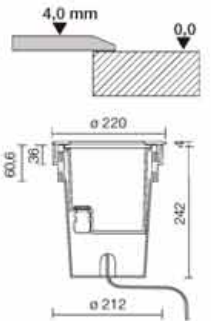

OP. A richiesta - On request: Cavo di alimentazione con dispositivo anti-traspirazione acqua
Power cable with anti-transpiration device

ACC. 646308 Connettore IP68 a da 7 a 12mm - IP68 connector ø from 7 to 12mm
646336 Connettore IP68 a "T" ø da 7 a 10mm per file continue
T-shaped IP68 connector to ø from 7 to 10mm for continuous line

NUOVO MATERIALE TERMOPLASTICO SUPER RESISTENTE
NEW THERMOPLASTIC MATERIAL SUPER RESISTANT

Velocità max carrabilità 20 km-h
Drive-over max speed 20 km-h
Carico statico 2000 kg
Static load 2000 kg

ALIMENTATORI-KIT RGB (se non in dotazione) da ordinare della sezione arancio - DRIVERS-RGB KITS (when not supplied) to be ordered from the section orange color

LOCKsystem range

OLODUM COB

DATI FOTOMETRICI - PHOTOMETRIC DATA

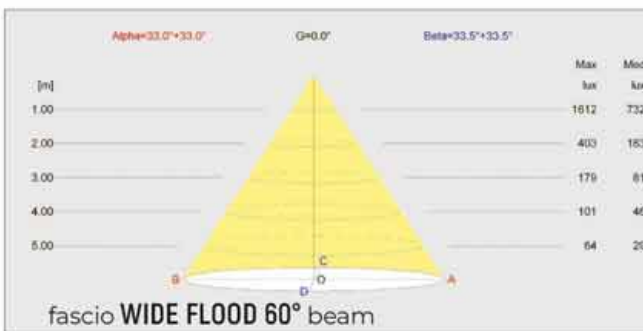
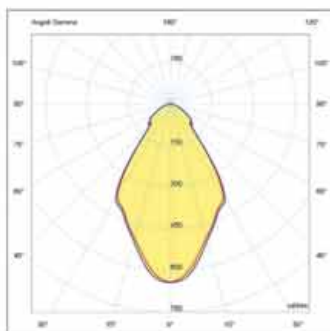
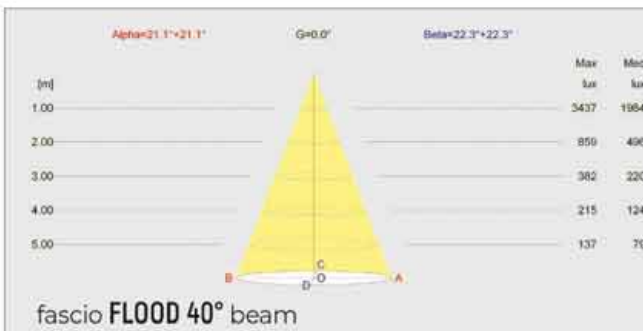
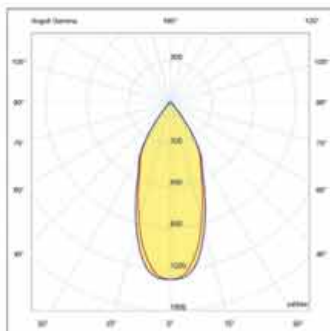
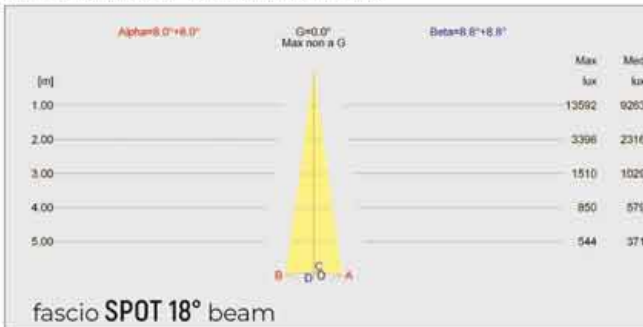
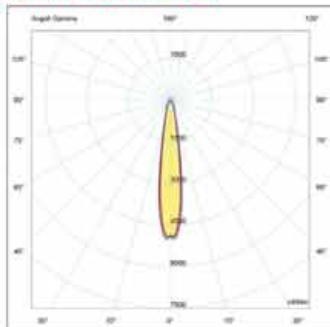



OLODUM MINI FULL GLASS COB



- Corpo in pressofusione di alluminio, verniciato in polveri con pretrattamento speciale per esterni.
- Vetro in cristallo extrachiario temperato di spessore 10 mm completo di guarnizione in silicone.
- Completo di pozzetto in materiale termoplastico con cornice in acciaio Inox [AISI 316].
- Pressacavi per il collegamento in cascata in ottone nichelato PG11.
- Spot made of powder coated die-cast aluminium with pretreatment for outdoor use.
- Finishing tempered glass 10 mm thick and gasket between glass and cover of silicone rubber.
- External housing of thermoplastic material and stainless steel [AISI 316] ring.
- Cable gland PG11 of nickel plated brass with predisposition for through-wiring.

LED COB	Inch	W	lm	LED								SISTEMA-SYSTEM		
				W	lm	V	K	°	CRI	T	W	lm	W	
E8384CTV-BC15 E8384CTV-BC24 E8384CTV-BC40	15 24 40	12,3W	1040	350mA	3000	>90	55°	•	•	14,3W	896	62		
		12,9W	1430			>90			14,9W	1207	81			
		12,9W	1340			>90			14,9W	1136	76			
E8384CTV-BN15 E8384CTV-BN24 E8384CTV-BN40	15 24 40	12,3W	1120	350mA	4000	>90	55°	•	•	14,3W	965	67		
		12,9W	1510			>90			14,9W	1274	86			
		12,9W	1430			>90			12,9W	1194	80			

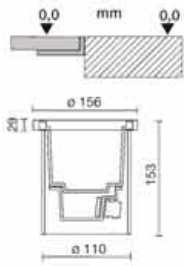

ALIMENTATORI CONSIGLIATI - DRIVERS RECOMMENDED

644759-1	ON-OFF	15W	IP20	350mA
J350-68-LED	ON-OFF	15W	IP68	350mA
646258-67	ON-OFF	13W	IP67	350mA

ACC. 646308 Connettore IP68 Ø da 7 a 12mm - IP68 connector Ø from 7 to 12mm



E960 Ventosa per rimuovere vetro - Glass remover



outside

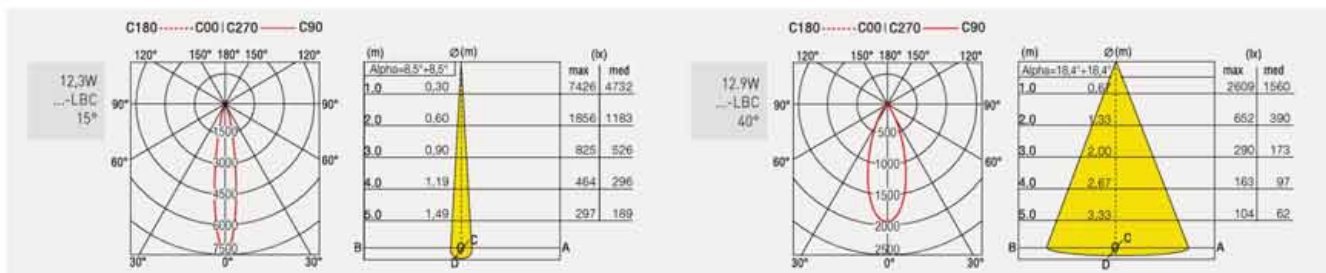

ALIMENTATORI-KIT RGB (se non in dotazione) da ordinare dalla sezione arancio - DRIVERS-RGB KITS (when not supplied) to be ordered from the section orange color



OLODUM MIDI FULL GLASS



- Corpo in pressofusione di alluminio, verniciato in polveri con pretrattamento speciale per esterni.
 - Vetro in cristallo extrachiario temperato di spessore 10 mm completo di guarnizione in silicone.
 - Completo di pozzetto in materiale termoplastico con cornice in acciaio Inox (AISI 316).
 - Pressacavi per il collegamento in cascata in ottone nichelato PG11.
- Spot made of powder coated die-cast aluminium with pretreatment for outdoor use.
 - Finishing tempered glass 10 mm thick and gasket between glass and cover of silicone rubber.
 - External housing of thermoplastic material and stainless steel (AISI 316) ring.
 - Cable gland PG11 of nickel plated brass with predisposition for through-wiring.



	LED	SISTEMA-SYSTEM										
		W	lm	V	K	CRi	T	W	lm	lm		
	OLODUM MIDI FULL GLASS E8267TVLBC-24 E8267TVLBN-24	26W	2760 2900	220-240V	3000 4000	>90	65°	•	•	30W	2126 2234	71 74
	E8267TVLBC-40 E8267TVLBN-40	26W	2650 2780	220-240V	3000 4000	>90	65°	•	•	30W	2106 2210	70 74

OP. E...LGI = LED giallo-yellow E...LRO = LED rosso-red E...LVE = LVE verde-green
 ...TSC TORX Viti di sicurezza - Safety screws

ACC. **646308** Connettore IP68 Ø da 7 a 12mm - IP68 connector Ø from 7 to 12mm
E960 Ventosa per rimuovere vetro - Glass remover

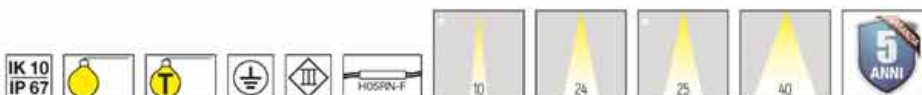

Carico statico 1000 kg
 Static load 1000 kg



ALIMENTATORI-KIT RGB (se non in dotazione) da ordinare dalla sezione arancio - DRIVERS-RGB KITS (when not supplied) to be ordered from the section orange color



ANDROS

ANDROS

ANDROS

ANDROS

ANDROS

ANDROS

ANDROS

ANDROS

ANDROS

ANDROS...SALDI...

SALE

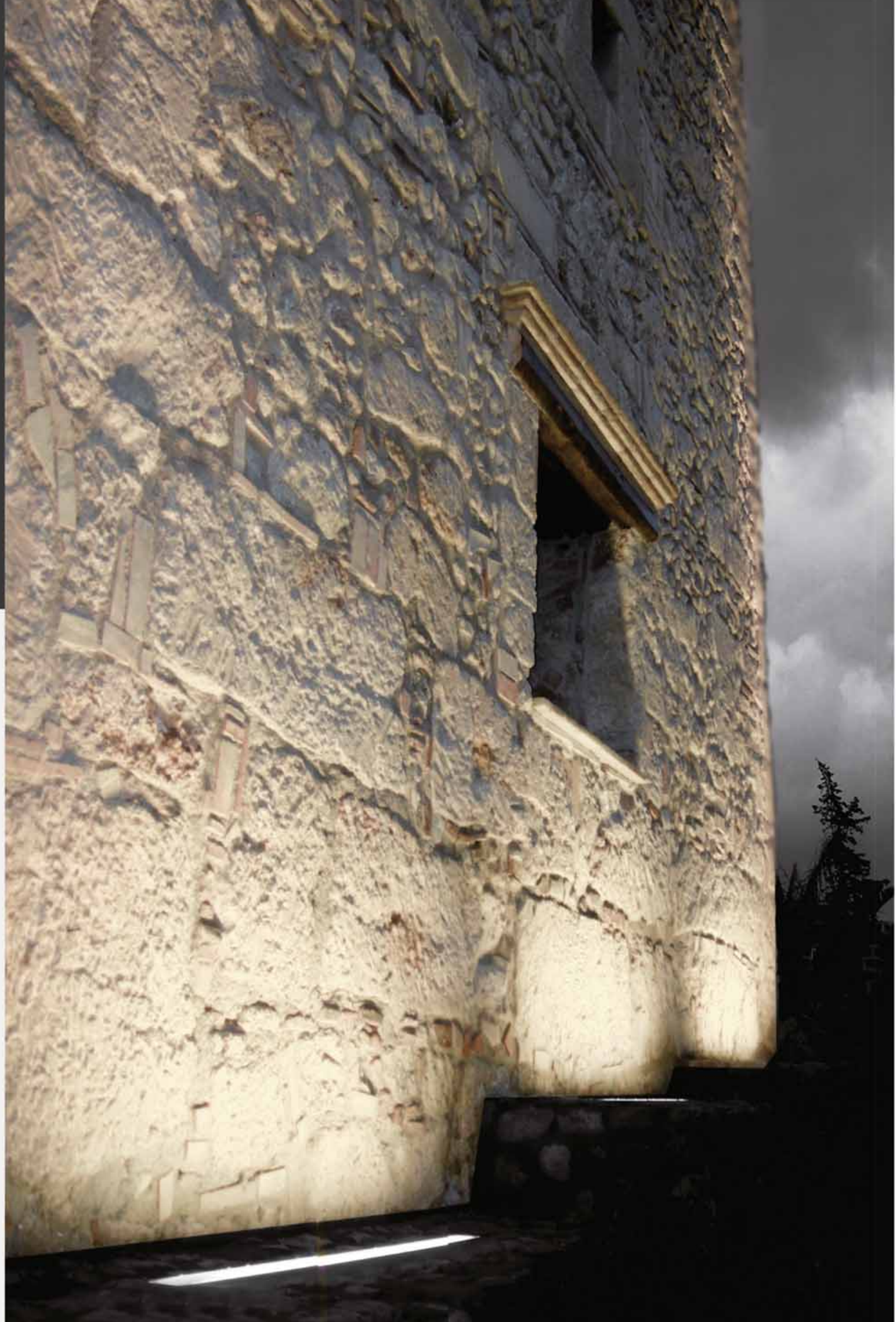

LONGLIGHT



- Corpo in estruso di alluminio anodizzato.
- Cornice in acciaio Inox (AISI 316) satinato, cassaforma in acciaio Inox (AISI 316).
- Guarnizioni in gomma siliconica.
- Testate in alluminio pressofuso fosfocromate e verniciate.
- Vetro temperato di spessore 10 mm trasparente.
- Cavo di alimentazione lunghezza 1 m. collegato all'apparecchio.



- Extruded aluminium body anodized.
- Frame in Inox (AISI 316) brushed, ground-wall housing in Inox (AISI 316).
- Silicon rubber gasket.
- End caps of die-cast aluminium, painted with phosphorchrome treatment.
- Tempered glass 10 mm thick, transparent.
- Power cable 1 m. length connected to the fitting.

	L (mm)	LED						SISTEMA-SYSTEM		
		W	lm	V	K	CRi	T	W	lm	W
STANDARD Con telaio di finitura in battuta With smooth finishing frame										
 105 85 57 110	375	12x1,2W	970 1050	220-240V 24Vdc	3000 4000	>90	38°	16W	873 945	54 59
	935	36x1,2W	2900 3150	220-240V 24Vdc	3000 4000	>90	42°	46W	2360 2550	51 55
	1236	48x1,2W	3870 4200	220-240V 24Vdc	3000 4000	>90	42°	60W	3490 3780	58 63
	1536	60x1,2W	4800 5250	220-240V 24Vdc	3000 4000	>90	42°	74W	4365 4725	59 64
FLAT Con telaio di finitura a filo With flush finishing frame										
 103 108 57 110	380	12x1,2W	970 1050	220-240V 24Vdc	3000 4000	>90	38°	16W	873 945	54 59
	940	36x1,2W	2900 3150	220-240V 24Vdc	3000 4000	>90	42°	46W	2360 2550	51 55
	1240	48x1,2W	3870 4200	220-240V 24Vdc	3000 4000	>90	42°	60W	3490 3780	58 63
	1540	60x1,2W	4800 5250	220-240V 24Vdc	3000 4000	>90	42°	74W	4365 4725	59 64

OP. *A richiesta - On request: apertura fascio - light beam
 A richiesta - On request: disponibile - available

ACC. **646308** Connettore IP68 Ø da 7 a 12mm - IP68 connector Ø from 7 to 12mm

Carico statico 500 kg
 static load 500 kg

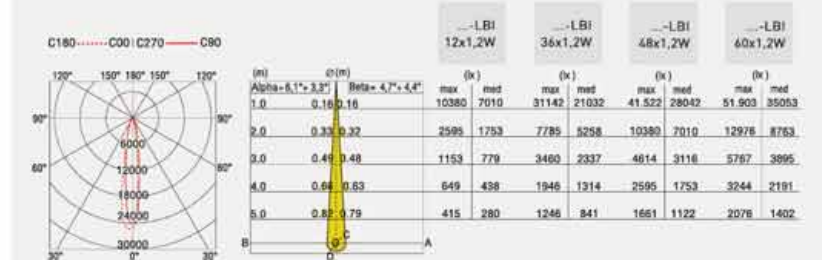

ALIMENTATORI-KIT RGB (se non in dotazione) da ordinare dalla sezione arancio - DRIVERS-RGB KITS (when not supplied) to be ordered from the section orange color

INCASSI A TERRA • INGROUND





LONGLIGHT SMD

- Corpo in estruso di alluminio anodizzato.
- Cornice in acciaio Inox (AISI 316) satinato, cassaforma in acciaio Inox (AISI 316).
- Guarnizioni in gomma silconica.
- Testate in alluminio pressofuso fosfocromate e verniciate.
- Vetro temperato di spessore 10 mm sabbatiato.
- Cavo di alimentazione lunghezza 1 m. collegato all'apparecchio.

- Extruded aluminium body anodized.
- Frame in Inox (AISI 316) brushed, housing in Inox (AISI 316).
- Silicon rubber gasket.
- End caps of die-cast aluminium, painted with phosphorchrome treatment.
- Tempered glass 10 mm thick, frosted.
- Power cable 1 m. length connected to the fitting.



L (mm)	LED							SISTEMA-SYSTEM					
	W	lm	V	K	CRI	T	W	lm	W				
<p>Con telaio di finitura in battuta With smooth finishing frame</p>													
375	Inox	E8900-LBC	tot. 1.5W	64	220-240V	3000	>70	32°	•	-	2.5W	46	18
	Inox	E8900-LBN	18 LED SMD	65	12Vdc	4000						47	19
375	Inox	E8910-LBC	tot. 3W	128	220-240V	3000	>70	35°	•	-	4W	92	23
	Inox	E8910-LBN	36 LED SMD	129	12Vdc	4000					93	23	
935	Inox	E8920-LBC	tot. 4W	173	220-240V	3000	>70	38°	•	-	5W	125	25
	Inox	E8920-LBN	48 LED SMD	176	12Vdc	4000					129	26	
935	Inox	E8930-LBC	tot. 8W	341	220-240V	3000	>70	42°	•	-	9W	246	27
	Inox	E8930-LBN	96 LED SMD	346	12Vdc	4000					250	28	
<p>Con telaio di finitura a filo With flush finishing frame</p>													
380	Inox	E8905-LBC	tot. 1.5W	64	220-240V	3000	>70	32°	•	-	2.5W	46	18
	Inox	E8905-LBN	18 LED SMD	65	12Vcc	4000					47	19	
380	Inox	E8915-LBC	tot. 3W	128	220-240V	3000	>70	35°	•	-	4W	92	23
	Inox	E8915-LBN	36 LED SMD	129	12Vcc	4000					93	23	
940	Inox	E8925-LBC	tot. 4W	173	220-240V	3000	>70	38°	•	-	5W	125	25
	Inox	E8925-LBN	48 LED SMD	176	12Vcc	4000					127	26	
940	Inox	E8935-LBC	tot. 8W	341	220-240V	3000	>70	42°	•	-	9W	246	27
	Inox	E8935-LBN	96 LED SMD	346	12Vcc	4000					250	28	

ACC. 646308 Connettore IP68 ø da 7 a 12mm - IP68 connector ø from 7 to 12mm

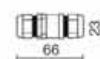

IK 09
IP 67



Carico statico 500 kg
static load 500 kg

outside

ALIMENTATORI-KIT RGB (se non in dotazione) da ordinare della sezione arancio - DRIVERS-RGB KITS (when not supplied) to be ordered from the section orange color



LONGLIGHT ECO



- Corpo in estruso di alluminio anodizzato.
- Cornice in acciaio Inox (AISI 316) satinato, cassaforma in acciaio Inox (AISI 316).
- Guarnizioni in gomma silconica.
- Testate in alluminio pressofuso fosfocromatate e verniciate.
- Vetro temperato di spessore 10 mm trasparente.
- Cavo alimentazione lunghezza 1m.

- Extruded aluminium body anodized.
- Frame in Inox (AISI 316) brushed, ground-wall housing in Inox (AISI 316).
- Silicon rubber gasket.
- End caps of die-cast aluminium, painted with phosphorchrome treatment.
- Tempered glass 10 mm thick, transparent.
- Power cable lenght 1m.



L (mm)	LED				SISTEMA-SYSTEM			
	W	lm	V	K	W	lm	lm/W	
STANDARD Con telaio di finitura in battuta With smooth finishing frame								
375	5x1,2W	480 520	220-240V [350mA]	3000 4000	>90	8W	438 472	55 59
935	18x1,2W	1440 1560	220-240V [350mA]	3000 4000	>90	24W	1315 1420	55 59
1236	24x1,2W	1920 2080	220-240V [350mA]	3000 4000	>90	32W	1750 1890	55 59
1536	30x1,2W	2400 2600	220-240V [350mA]	3000 4000	>90	39W	2186 2362	56 60
1536	30x1,2W	-	220-240V [350mA]	RGB	-	-	-	-
FLAT Con telaio di finitura a filo With flush finishing frame								
380	5x1,2W	480 520	220-240V [350mA]	3000 4000	>90	8W	438 472	55 59
940	18x1,2W	1440 1360	220-240V [350mA]	3000 4000	>90	24W	1315 1420	55 59
1240	24x1,2W	1920 2080	220-240V [350mA]	3000 4000	>90	32W	1750 1890	55 59
1540	30x1,2W	2400 2600	220-240V [350mA]	3000 4000	>90	39W	2186 2362	56 60
1540	30x1,2W	-	220-240V [350mA]	RGB	-	-	-	-

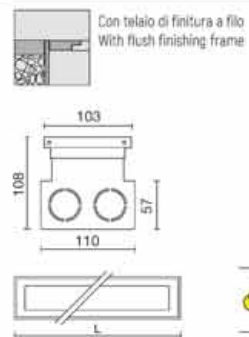
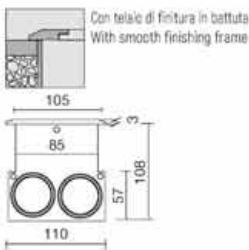

OP. "A richiesta - On request: apertura fascio - light beam"

A richiesta - On request: disponibile - available



ACC. 646308 Connettore IP68 Ø da 7 a 12mm - IP68 connector Ø from 7 to 12mm

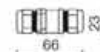

IK 09
IP 67



Carico statico 500 kg
static load 500 kg

outside

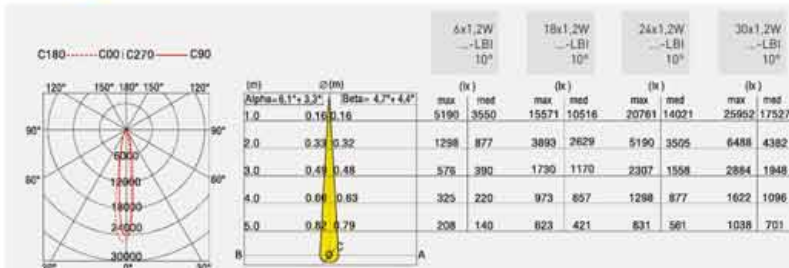

ALIMENTATORI-KIT RGB (se non in dotazione) da ordinare dalla sezione arancio - DRIVERS-RGB KITS (when not supplied) to be ordered from the section orange color

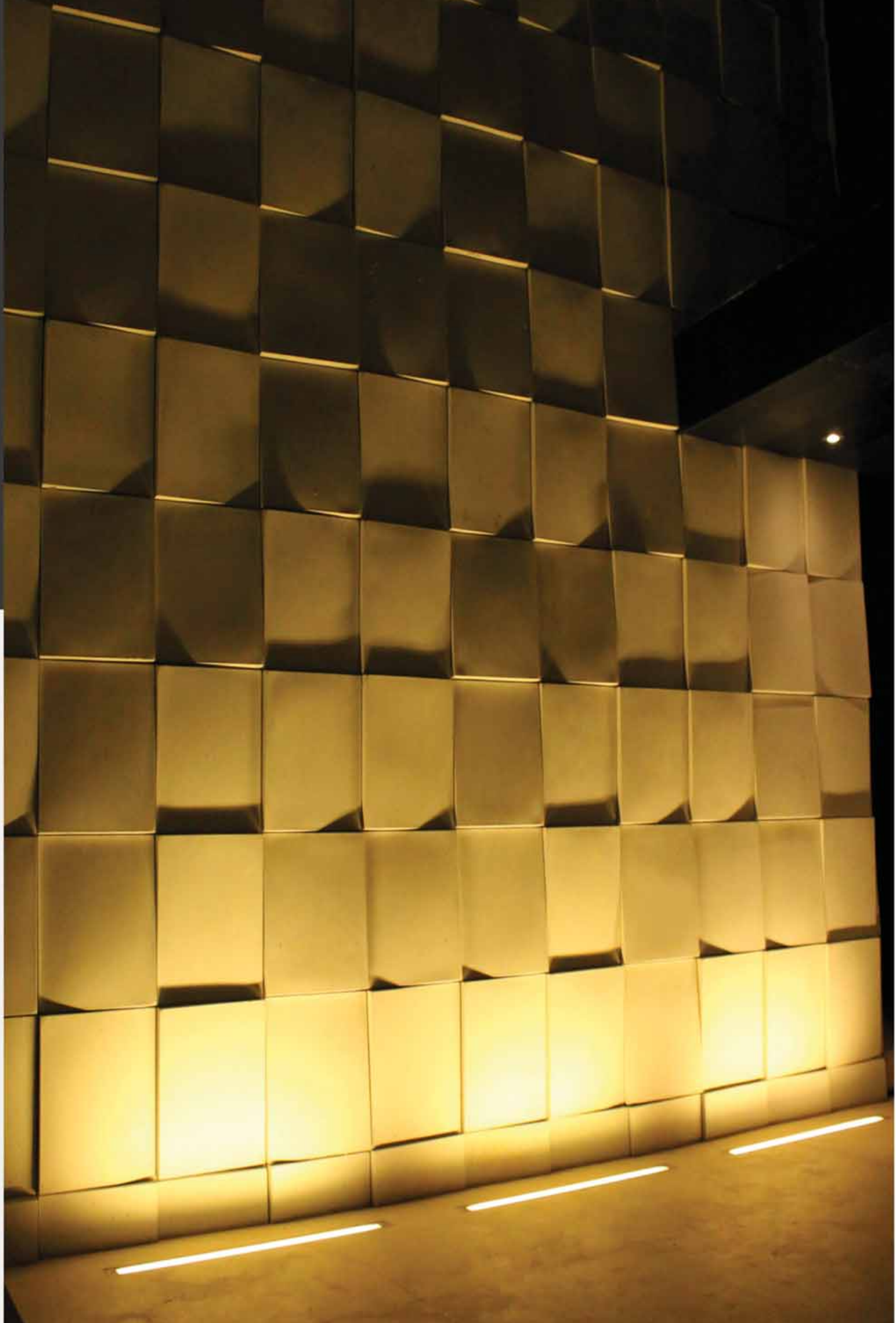

LONGLIGHT ECO ASIMMETRICO



- Corpo in estruso di alluminio anodizzato.
- Cornice in acciaio Inox (AISI 316) satinato, cassaforma in acciaio Inox (AISI 316).
- Guarnizioni in gomma silconica.
- Testate in alluminio pressofuso fosfocromatate e verniciate.
- Vetro temperato di spessore 10 mm trasparente.

- Extruded aluminium body anodized.
- Frame in Inox (AISI 316) brushed, ground-wall housing in Inox (AISI 316).
- Silicon rubber gasket.
- End caps of die-cast aluminium, painted with phosphochrome treatment.
- Tempered glass 10 mm thick, transparent.



L (mm)	LED								SISTEMA-SYSTEM		
	W	Im	V	K	CRI	T	IP	W	Im	W	
STANDARD Con telaio di finitura in battuta With smooth finishing frame											
375	Inox	E8941AS-LBC-6	670	220-240V	3000	>90	•	8W	600	75	
	Inox	E8941AS-LBN-6	700	4000	4000		•	627	78		
	Inox	E8941AS-LBI-6	730	6000	6000		•	654	82		
935	Inox	E8951AS-LBC18	2010	220-240V	3000	>90	•	24W	1800	75	
	Inox	E8951AS-LBN18	2100	4000	4000		•	1880	78		
	Inox	E8951AS-LBI18	2190	6000	6000		•	1960	82		
1236	Inox	E8957AS-LBC24	2880	220-240V	3000	>90	•	32W	2400	75	
	Inox	E8957AS-LBN24	2800	4000	4000		•	2509	78		
	Inox	E8957AS-LBI24	2920	6000	6000		•	2616	82		
1536	Inox	E8958AS-LBC30	3350	220-240V	3000	>90	•	39W	3000	77	
	Inox	E8958AS-LBN30	3500	4000	4000		•	3136	80		
	Inox	E8958AS-LBI30	3650	6000	6000		•	3270	84		
1536	Inox	E8958AS-RGB30	-	220-240V	[Color]	-	•	-	-	-	
FLAT Con telaio di finitura a filo With flush finishing frame											
380	Inox	E8946AS-LBC-6	670	220-240V	3000	>90	•	8W	600	75	
	Inox	E8946AS-LBN-6	700	4000	4000		•	627	78		
	Inox	E8946AS-LBI-6	730	6000	6000		•	654	82		
940	Inox	E8956AS-LBC18	2010	220-240V	3000	>90	•	24W	1800	75	
	Inox	E8956AS-LBN18	2100	4000	4000		•	1880	78		
	Inox	E8956AS-LBI18	2190	6000	6000		•	1960	82		
1240	Inox	E8942AS-LBC24	2880	220-240V	3000	>90	•	32W	2400	76	
	Inox	E8942AS-LBN24	2800	4000	4000		•	2509	78		
	Inox	E8942AS-LBI24	2920	6000	6000		•	2616	82		
1540	Inox	E8943AS-LBC30	3350	220-240V	3000	>90	•	39W	3000	77	
	Inox	E8943AS-LBN30	3500	4000	4000		•	3136	80		
	Inox	E8943AS-LBI30	3650	6000	6000		•	3270	84		
1540	Inox	E8943AS-RGB30	-	220-240V	[Color]	-	•	-	-	-	

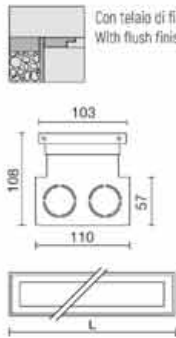
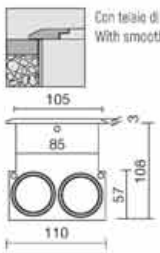

OP. A richiesta - On request: disponibile - available

ACC. 646308 Connettore IP68 Ø da 7 a 12mm - IP68 connector Ø from 7 to 12mm

Carico statico 500 kg
 static load 500 kg

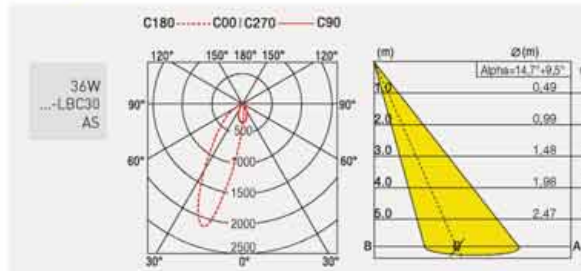

ALIMENTATORI-KIT RGB (se non in dotazione) da ordinare dalla sezione arancio - DRIVERS-RGB KITS (when not supplied) to be ordered from the section orange color



EYES COVER



29,5 mm



- Corpo e calotta in acciaio Inox (AISI 316L).
 - Finitura: Lucidato.
 - Guarnizioni in gomma silconica.
 - Vetro temperato extra chiaro.
 - Vite premi guarnizione in ottone nichelato.
 - In dotazione cavo 2x0,5mmq lunghezza 500mm.
 - Led durata utile: 50.000 (h) L80 B10.
- Body and cap made of (AISI 316L) stainless steel.
 - Finishing: Polished.
 - Silicone rubber gaskets.
 - Extra clear tempered glass.
 - Packing nut of nickel-plated brass.
 - Supplied cable 2x0,5sqmm length 500mm.
 - Led life: 50.000 (h) L80 B10.

		45°	125°	W	lm	V	K	CRI	T	IP
	MONO EMISSIONE - MONO EMISSION									
	Inox	E875-LBC	E877-LBC	1,5W	145		3000	>90		
		E875-LBN	E877-LBN		155	500mA	4000			
		E875-LBI	E877-LBI		165		6000			
	DOPPIA EMISSIONE - DOUBLE EMISSION									
	Inox	E876-LBC	E878-LBC	1,5W	145		3000	>90		
	E876-LBN	E878-LBN		155	500mA	4000				
	E876-LBI	E878-LBI		165		6000				
ALIMENTATORI CONSIGLIATI - RECOMMENDED DRIVERS										
	644758-5	ON-OFF		6W	IP20					
	645496	ON-OFF		12W	IP20	500mA				
	645086	ON-OFF		20W	IP20					
	645626-1	ON-OFF		26W	IP67					

		KIT APPARECCHIO + ALIMENTATORE - FITTING + DRIVER		W	V	K	CRI	T	IP	
	MONO EMISSIONE - MONO EMISSION									
	Inox	KTE875-LBC	KTE877-LBC	2,5W	145	220-240V	3000	>90		
		KTE875-LBN	KTE877-LBN		155	500mA	4000			
		KTE875-LBI	KTE877-LBI		165		6000			
	DOPPIA EMISSIONE - DOUBLE EMISSION									
	Inox	KTE876-LBC	KTE878-LBC	2,5W	145	220-240V	3000	>90		
	KTE876-LBN	KTE878-LBN		155	500mA	4000				
	KTE876-LBI	KTE878-LBI		165		6000				

ACC. 186-3 Cassaforma per incasso - Housing for recessed

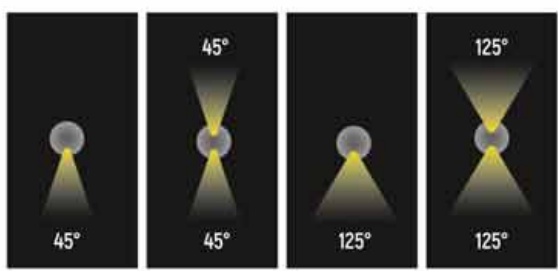
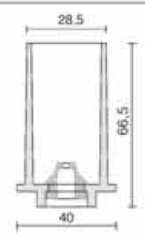

*Solo apparecchio - Only fitting

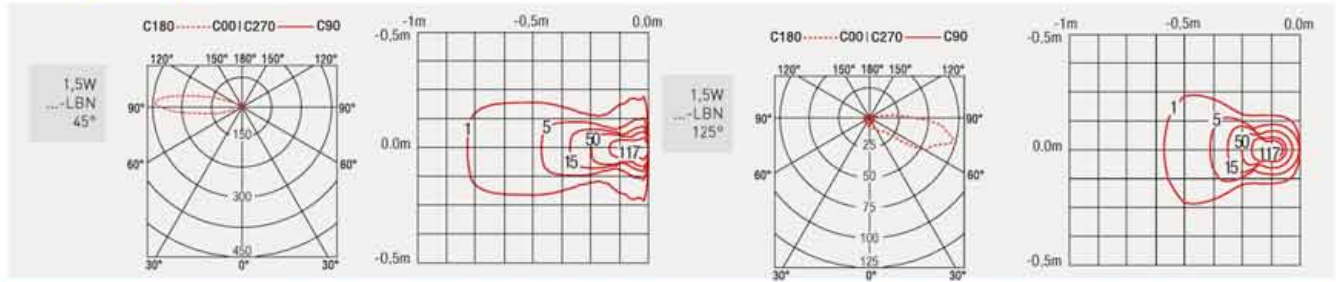

ALIMENTATORI-KIT RGB (se non in dotazione) da ordinare dalla sezione arancio - DRIVERS-RGB KITS (when not supplied) to be ordered from the section orange color



OLODUM MICRO COVER - MICRO PASS

- Corpo in acciaio Inox.
- Viterie in acciaio Inox.
- Guarnizioni in gomma silconica.
- Schermo diffusore in metacrilato (Micro Pass).
- Calotta per diffusione radiale in pressofusione di alluminio a 8 cave (Micro Cover).
- Copertura in acciaio Inox lucidata (Micro Pass).
- Doppia verniciatura in polveri con pretrattamento speciale per esterni.
- Cassaforma di contenimento in PA (da ordinare a parte).
- Pressacavo in ottone nichelato PG7 (diametro cavi utilizzabili 5+7 mm).

- Body of stainless steel.
- Stainless steel screws.
- Silicon rubber gaskets.
- Methacrylate diffuser (Micro Pass).
- Die-cast aluminium canopy for radial diffusion with 8 openings (Micro Cover).
- Inox steel canopy (Micro Pass).
- Double painted powder coated with outdoor special treatment.
- External housing made of PA (to be ordered separately).
- PG7 nickel brass cable gland (use cables diameter 5+7 mm).



	W	lm	V	K	CRI	T	
MICRO COVER							
BORDER CON LED A LUCE RADENTE - LED RAZING LIGHT							
Gr	E8392-LBI	1,5W		220-240V	5600	>90	38°
	E8392-LBL	8 LED 5M2					
MICRO PASS							
INCASSO DA SEGNALAZIONE - RECESSED FOR SIGNAL							
	E8394-VD-LRO	-	-	-	-	-	-
	E8394-VD-LBC	1x1,2W	70-195	350mA	3000	>90	36°
	E8394-VD-LBN	1x2,5W	109-195	700mA	4000	>90	36°
	E8394-VD-LBL	-	-	-	-	-	-
	E8394-VD-RGB	1x3,5W	-	350mA		>90	36°

■ il parametro più basso si riferisce sempre alla potenza inferiore - The lowest value is always referred to the lowest watt

ALIMENTATORI CONSIGLIATI - RECOMMENDED DRIVERS

646258-67	ON-OFF	15W	IP67	350mA
644758	ON-OFF	8W	IP20	350mA
644759-1	ON-OFF	15W	IP20	350mA
J350-68-LED	ON-OFF	15W	IP68	350mA
644940	ON-OFF	12W	IP40	700mA
644940-67	ON-OFF	10W	IP67	700mA
644936	ON-OFF	25W	IP40	700mA
644936-67	ON-OFF	25W	IP67	700mA

DP. A richiesta apparecchio con alimentazione a 24V - On request power supply 24V

—TSC TORX Viti di sicurezza - Safety screws

ACC. 185 Cassaforma per incasso - Housing for recessed



646308 Connettore IP68 Ø da 7 a 12mm - IP68 connector Ø from 7 to 12mm



IK 10
IP 67



Carico statico 500 kg
Static load 500 kg

outside

ALIMENTATORI-KIT RGB (se non in dotazione) da ordinare dalla sezione arancio - DRIVERS-RGB KITS (when not supplied) to be ordered from the section orange color

OLODUM MICRO COVER AL



- Corpo Inox (AISI 316L).
- Calotta in alluminio pressofuso.
- Doppia verniciatura in polveri poliesteri.
- Diffusore in policarbonato anti-UV.
- Cassaforma di contenimento in PA (da ordinare a parte).
- Pressacavo in ottone nichelato PG7 (diametro cavi utilizzabili 5+7 mm).
- Viti in acciaio Inox.

- Body of inox (AISI 316L).
- Die-cast aluminium cover.
- Double powder coated painting.
- Anti-UV polycarbonate diffuser.
- Housing made of PA (not included).
- PG7 nickel brass cable gland (use cables diameter 5+7 mm).
- Inox steel screws.

(W)
(lm)
(V)
(K)
(CRI)
(T)

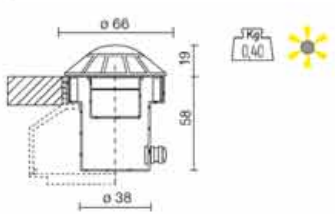

RADIALE CON POWERLED - POWERLED RADIAL

Gr	Power	Beam Angle	Current	Wavelength	CRI	Temp	Other
E8399-LBC	70	-	350mA	3000	>90	-	•
E8399-LBN	1x1,2W	109	-	4000	-	•	•
E8399-LBL	-	-	-	470nm	-	•	•

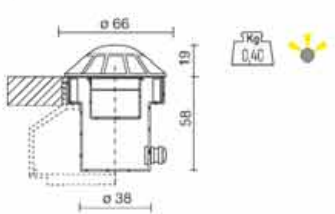

MONO EMISSIONE CON POWERLED - POWERLED MONO EMISSION

Gr	Power	Beam Angle	Current	Wavelength	CRI	Temp	Other
E8399-1-LBC	70	-	350mA	3000	>90	-	•
E8399-1-LBN	1x1,2W	109	-	4000	-	•	•
E8399-1-LBL	-	-	-	470nm	-	•	•



ALIMENTATORI CONSIGLIATI - RECOMMENDED DRIVERS

644758	ON-OFF	6W	IP20	350mA
646258-67	ON-OFF	13W	IP67	350mA
644759-1	ON-OFF	15W	IP20	350mA
3550-68-LED	ON-OFF	15W	IP68	350mA

OP: TSC TORX Viti di sicurezza - Safety screws

ACC. 185 Cassaforma per incasso - Housing for recessed

646308 Connettore IP68 Ø da 7 a 12mm - IP68 connector Ø from 7 to 12mm



Carico statico 2000 kg Static load 2000 kg Velocità max carrabilità 5 Km-h Driver-over max speed 5Km-h



ALIMENTATORI-KIT RGB (se non in dotazione) da ordinare dalla sezione arancio - DRIVERS-RGB KITS (when not supplied) to be ordered from the section orange color

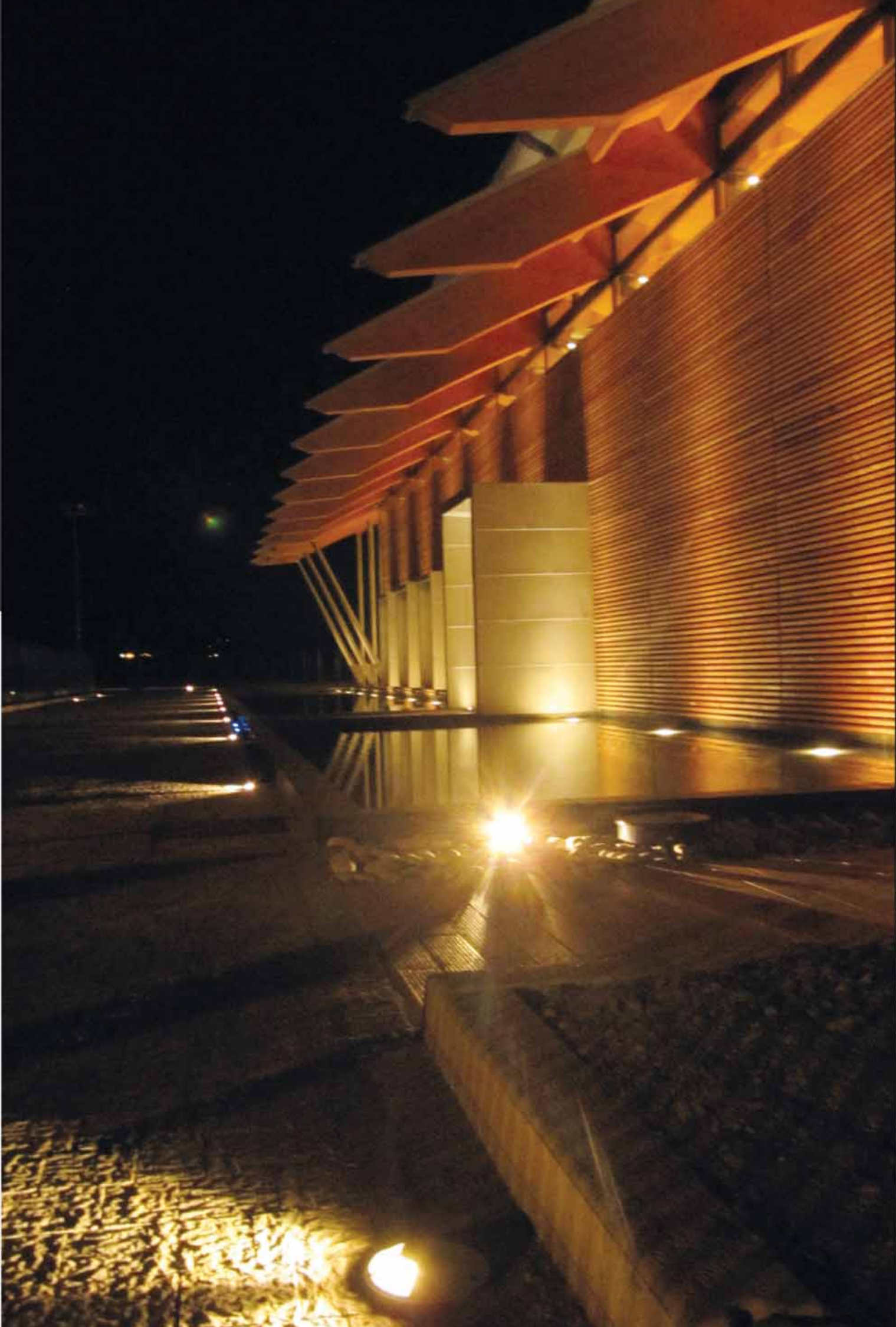

OLODUM MINI COVER AL



- Corpo e calotta in pressofusione di alluminio.
- Doppia verniciatura in polveri poliestere con pretrattamento speciale per esterni.
- Uscita luce mono-bi-radiale.
- Diffusore in vetro stampato.
- Cassaforma di contenimento in PA.
- Pressacavo in ottone nichelato PG11.

- Body and cover made of die-cast aluminium.
- Double powder coated painting with outdoor special treatment.
- Mono-bi-radial diffusion.
- Printed glass diffuser.
- Housing made of PA.
- PG11 cable gland of nickel plated brass.

	W	lm	V	K	CRI	T		
MONO EMISSIONE CON POWERLED - POWERLED MONO EMISSION								
 ø 130 27 180 ø 150	E8396-LBC	120		3000				
	E8396-LBN	130	220-240V	4000				
	E8396-LBI	140	(500mA)	6000	>90	-	•	•
	E8396-LBL	-		470nm				
DOPPIA EMISSIONE CON POWERLED - POWERLED DOUBLE EMISSION								
 ø 150	E8397-LBC	120		5000				
	E8397-LBN	130	220-240V	4000				
	E8397-LBI	140	(500mA)	6000	>90	-	•	•
	E8397-LBL	-		470nm				
RADIALE CON POWERLED - POWERLED RADIAL								
 ø 105	E8398-LBC	120		3000				
	E8398-LBN	130	220-240V	4000				
	E8398-LBI	140	(500mA)	6000	>90	-	•	•
	E8398-LBL	-		470nm				



Possibilità di sfilare il fondo della cassaforma
 Possibility to take off the bottom

OP: -TSC TORX Viti di sicurezza - Safety screws

ACC: **646308** Connettore IP68 ø da 7 a 12mm - IP68 connector ø from 7 to 12mm



Carico statico 2000 kg Static load 2000 kg
 Velocità max carrabilità 5 Km-h Driver-over max speed 5Km-h

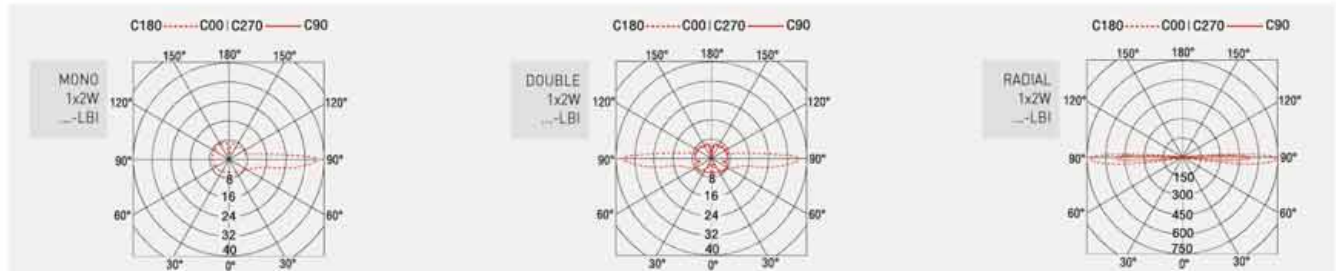

ALIMENTATORI-KIT RGB (se non in dotazione) da ordinare dalla sezione arancio - DRIVERS-RGB KITS (when not supplied) to be ordered from the section orange color



OLODUM STANDARD COVER



- Apparecchi con calotta e corpo in alluminio, verniciato in polveri epossidiche con pretrattamento speciale per esterni.
- Diffusore in vetro sabbato temperato.
- Pressacavo in ottone nichelato PG 13,5.
- Viterie in acciaio Inox.
- Guarnizioni in gomma siliconica.
- Die-cast aluminium cover and body, epoxy powder coated with pretreatment for outdoor use.
- PG 13,5 cable gland of nickel plated brass.
- Stainless steel screws.
- Silicon rubber gaskets.



	LED							SYSTEM-SYSTEM		
	W	lm	V	K	CRI	T	IP	W	lm	W
<p>MONO EMISSIONE CON POWERLED POWERLED MONO EMISSION</p> <p>JKg 3.00 Ni E8202-LBC E8202-LBN</p>	12W	1580	220-240V (700mA)	3000 4000	>90	-	• •	14W	280	20
<p>DOPPIA EMISSIONE CON POWERLED POWERLED DOUBLE EMISSION</p> <p>JKg 3.00 Ni E8203-LBC E8203-LBN</p>	24W	2760	220-240V (700mA)	3000 4000	>90	-	• •	28W	560	20

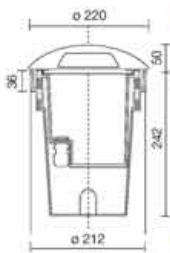

DR. -TSC TORX Viti di sicurezza - Safety screws

ACC. **646308** Connettore IP68 Ø da 7 a 12mm - IP68 connector Ø from 7 to 12mm



Carico statico 2000 kg
Static load 2000 kg

Velocità max carrabilità 5 Km-h
Driver-over max speed 5Km-h







INCASSI A SOFFITTO CEILING RECESSED

outside

• MICRO SPOT – EFFETTI LUCE - LIGHT EFFECTS



EYES PRO

448



EYES PRO M
TONDO

449



EYES PRO M
QUADRO

449



EYES BASIC A

451



EYES BASIC B

453



EYES A-1
TONDO

457



EYES A-1
QUADRO

457



EYES B-1
TONDO

459



EYES B-1
QUADRO

459



EYES WALL
FLAT COB TONDO

463



EYES WALL
FLAT COB QUADRO

463



EYES C

465



EYES ORIENTABILE

467

• DOWNLIGHTERS



CIELO 3 LED

468



CIELO COB

469



OLODUM MICRO C
TONDO

471



OLODUM MICRO C
QUADRO

471



OLODUM MINI C
TONDO

473



OLODUM MIDI C
TONDO

475



OLODUM STANDARD C
TONDO

477



EYES PRO

- Incasso in alluminio con Led ad alta emissione, lente e vetro di protezione.
- Anello di finitura in acciaio Inox (AISI 316) lucido e viti di fissaggio.
- Recessed aluminium fitting provided with high emission, lens and protection glass.
- Ring bright finishing made of Inox steel (AISI 316) and fixing screws.



26 mm

	10	30	W	lm	V	K	CRI
Inox	E893-LBC E893-LBI E893-LBL	E898-LBC E898-LBI E898-LBL	1x1,2W 1x2,5W	80-125 100-195	350mA 700mA	3000 6000 470nm	>90

ALIMENTATORI CONSIGLIATI - RECOMMENDED DRIVERS

Model	ON-OFF	W	IP	mA
644758	ON-OFF	6W	IP20	350mA
644759-1	ON-OFF	15W	IP20	350mA
644940	ON-OFF	12W	IP40	700mA
644936	ON-OFF	25W	IP40	700mA
646258-67	ON-OFF	13W	IP67	350mA
644940-67	ON-OFF	12W	IP40	700mA
644936-67	ON-OFF	27W	IP40	700mA

	KIT APPARECCHIO + ALIMENTATORE + FITTING + DRIVER		W	lm	V	K	CRI
Inox	KTE893-LBC KTE893-LBI KTE893-LBL	KTE898-LBC KTE898-LBI KTE898-LBL	3,5W	100-195	220-240V (700mA)	3000 6000 470nm	>90

Il parametro più basso si riferisce sempre alla potenza inferiore - The lowest value is always referred to the lowest watt

OP. Disponibile alimentatore in emergenza - Safety driver available

*A richiesta: fascio elicoidale - On request: Elissoidal beam 15°x99°

ACC. 189 Cassaforma in alluminio ossidato opaco completo di pressacavo in ottone nichelato tipo PG11
Housing main body made of satin aluminium complete with nickel coated brass cable gland PG11

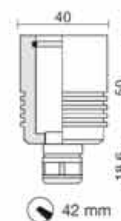

42 mm

* Solo apparecchio - Only fitting

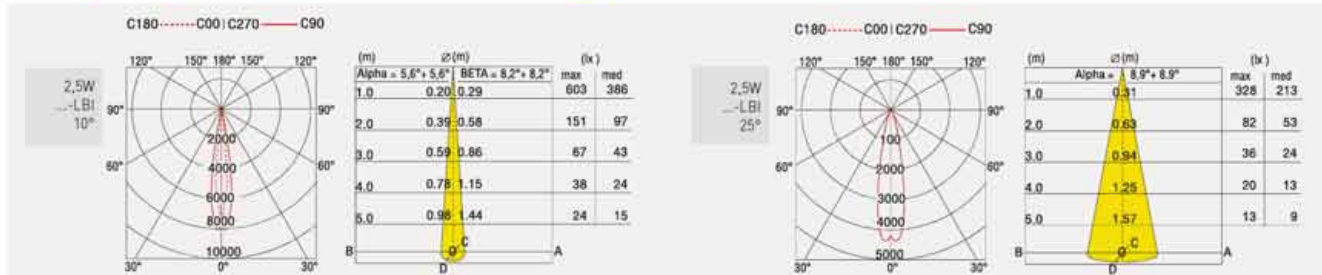

ALIMENTATORI-KIT RGB (se non in dotazione) da ordinare dalla sezione arancio - DRIVERS-RGB KITS (when not supplied) to be ordered from the section orange color

EYES PRO M



- Dissipatore, corpo e ghiera in alluminio anodizzato.
- Anello di finitura in ottone cromato.
- Lente con vetro di protezione.
- Per controsoffitti.
- Heatsink, housing and ring in anodized aluminium.
- Chromed brass finishing ring.
- Lens with protection glass.
- Forse false-ceiling.



41 mm Δ 0-25 mm

 60 3 ø46	 0.11	E893-M-LBC	E898-M-LBC	1x1,2W	80-125	350mA	3000	>90
		E893-M-LBI	E898-M-LBI	1x2,5W	100-195	700mA	6000	
		E893-M-LBL	E898-M-LBL				470nm	
 0.13	 0.13	E893-M-Q-LBC	E898-M-Q-LBC	1x1,2W	80-125	350mA	3000	>90
		E893-M-Q-LBI	E898-M-Q-LBI	1x2,5W	100-195	700mA	6000	
		E893-M-Q-LBL	E898-M-Q-LBL				470nm	

ALIMENTATORI CONSIGLIATI - RECOMMENDED DRIVERS

644758	ON-OFF	6W	IP20	350mA
644759-1	ON-OFF	15W	IP20	350mA
644940	ON-OFF	12W	IP40	700mA
644936	ON-OFF	25W	IP40	700mA
646258-67	ON-OFF	13W	IP67	350mA
644940-67	ON-OFF	12W	IP40	700mA
644936-67	ON-OFF	27W	IP40	700mA

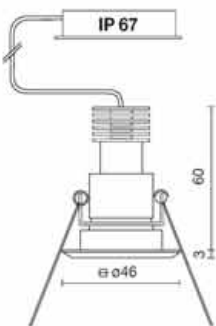

KIT APPARECCHIO + ALIMENTATORE - FITTING + DRIVER

 60 3 ø46	 0.11	KTE893-M-LBC	KTE898-M-LBC	3,5W	100-195	220-240V [700mA]	3000	>90
		KTE893-M-LBI	KTE898-M-LBI				6000	
		KTE893-M-LBL	KTE898-M-LBL				470nm	
 0.13	 0.13	KTE893M-Q-LBC	KTE898M-Q-LBC	3,5W	100-195	220-240V [700mA]	3000	>90
		KTE893M-Q-LBI	KTE898M-Q-LBI				6000	
		KTE893M-Q-LBL	KTE898M-Q-LBL				470nm	

■ Il parametro più basso si riferisce sempre alla potenza inferiore - The lowest value is always referred to the lowest v

OP: Disponibile alimentatore in emergenza - Safety driver available

*A richiesta: fascio ellissoidale - On request: Ellipsoidal beam 15°x90°

* Solo apparecchio - Only fitting

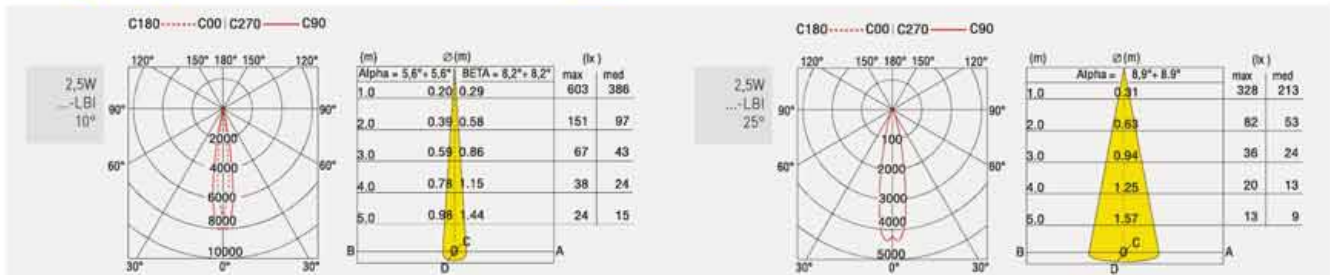
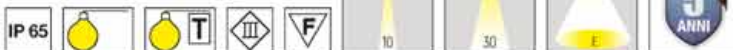

ALIMENTATORI-KIT RGB (se non in dotazione) da ordinare dalla sezione arancio - DRIVERS-RGB KITS (when not supplied) to be ordered from the section orange color



EYES BASIC A



16 mm



- Incasso con anello di finitura in ottone cromato.
- Fissaggio tramite ghiera per controsoffitti accessibili o molla per controsoffitti non accessibili.
- Recessed fitting with ring made of chromed brass.
- Fixing by lock nut for accessible false-ceilings or retain spring for inaccessible false-ceilings.

CON GHIERA DI BLOCCAGGIO PER CONTROSOFFITTI ACCESSIBILI - WITH LOCK NUT FOR ACCESSIBLE FALSE-CEILINGS							
Cr	E900-G-LBC	80	3000	1x12W	350mA	4000	>90
	E900-G-LBN	90	4000				
	E900-G-LBI	100	6000				

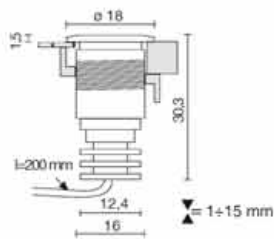

0,04 kg

CON MOLLA DI BLOCCAGGIO PER CONTROSOFFITTI NON ACCESSIBILI - WITH LOCK SPRING FOR UNACCESSIBLE FALSE-CEILING							
Cr	E900-M-LBC	80	3000	1x12W	350mA	4000	>90
	E900-M-LBN	90	4000				
	E900-M-LBI	100	6000				

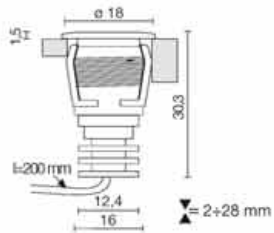

0,04 kg

ALIMENTATORI CONSIGLIATI - RECOMMENDED DRIVERS

644758	ON-OFF	6W	IP20	350mA
644759-1	ON-OFF	15W	IP20	350mA
646258-67	ON-OFF	13W	IP67	350mA

OP. Disponibile alimentatore in emergenza - Safety driver available

E...LBI = LED blu-blue

ACC. 186-5 Pozzetto per pareti solide per Eyes Basic A - A-1
Concrete walls pit for Eyes Basic A - A-1

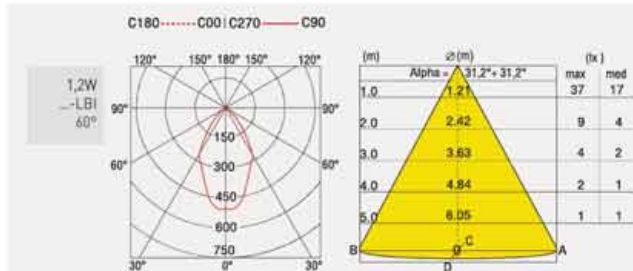

ALIMENTATORI-KIT RGB (se non in dotazione) da ordinare dalla sezione arancio - DRIVERS-RGB KITS (when not supplied) to be ordered from the section orange color



EYES BASIC B



- Incasso con anello di finitura in ottone cromato.
- Fissaggio tramite ghiera per controsoffitti accessibili o molla per controsoffitti non accessibili.
- Recessed fitting with ring made of chromed brass.
- Fixing by lock nut for accessible false-ceilings or lock spring for inaccessible false-ceilings.

K I T APPARECCHIO + ALIMENTATORE - FITTING + DRIVER
 CON GHIERA DI BLOCCAGGIO PER CONTROSOFFITTI ACCESSIBILI - WITH LOCK NUT FOR ACCESSIBLE FALSE-CEILINGS

Cr	W	lm	V	K	CRI
KTE895-G-LBC	1x1,2W	80-125	350mA	3000	>90
KTE895-G-LBI	1x2,5W	100-195	700mA	6000	
KTE895-G-LBL	-	-	-	470nm	
KTE896-G-LBC	1x1,2W	80-125	350mA	3000	>90
KTE896-G-LBI	1x2,5W	100-195	700mA	6000	
KTE896-G-LBL	-	-	-	470nm	

Technical drawing showing dimensions: diameter 45 mm, height 36.5 mm, mounting hole diameter 22 mm, and total width 28 mm. A note indicates a depth of 1±24 mm.

K I T APPARECCHIO + ALIMENTATORE - FITTING + DRIVER
 CON MOLLA DI BLOCCAGGIO PER CONTROSOFFITTI NON ACCESSIBILI - WITH LOCK SPRING FOR UNACCESSIBLE FALSE-CEILINGS

Cr	W	lm	V	K	CRI
KTE895-M-LBC	1x1,2W	80-125	350mA	3000	>90
KTE895-M-LBI	1x2,5W	100-195	700mA	6000	
KTE895-M-LBL	-	-	-	470nm	
KTE896-M-LBC	1x1,2W	80-125	350mA	3000	>90
KTE896-M-LBI	1x2,5W	100-195	700mA	6000	
KTE896-M-LBL	-	-	-	470nm	

Technical drawing showing dimensions: diameter 45 mm, height 36.5 mm, mounting hole diameter 22 mm, and total width 28 mm. A note indicates a depth of 5±28 mm.

K I T APPARECCHIO + ALIMENTATORE - FITTING + DRIVER
 ASIMMETRICO - CON MOLLA DI BLOCCAGGIO PER PARETI - ASYMMETRIC WITH LOCK SPRING FOR WALLS

Cr	W	lm	V	K	CRI
KTE895M-LBCAS	1x1,2W	80-125	350mA	3000	>90
KTE895M-LBIAS	1x2,5W	100-195	700mA	6000	
KTE895M-LBLAS	-	-	-	470nm	

■ Il parametro più basso si riferisce sempre alla potenza inferiore - The lowest value is always referred to the lowest watt

OP. Disponibile kit in emergenza da installare in remoto - Safety driver kit available
 A richiesta - On request: disponibile - available

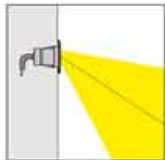

ACC. 186-3 Pozzetto per pareti solide per Eyes Basic B - B-1 - B-3
 Concrete walls pit for Eyes Basic B - B-1 - B-3

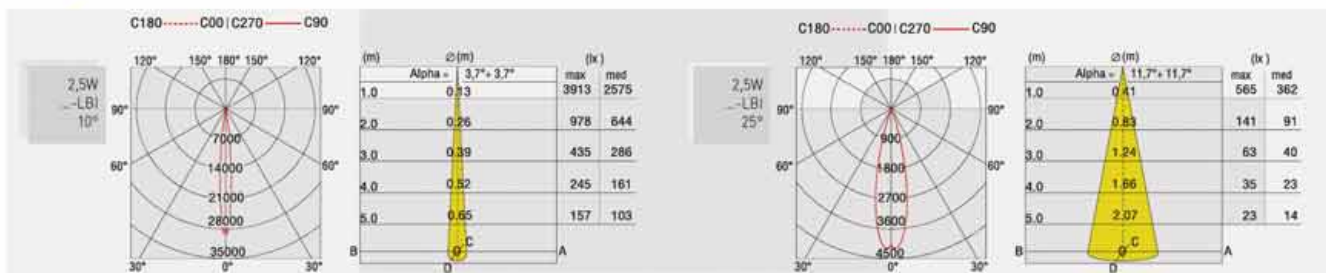
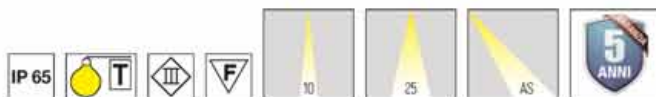
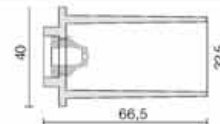

ALIMENTATORI-KIT RGB (se non in dotazione) da ordinare dalla sezione arancio - DRIVERS-RGB KITS (when not supplied) to be ordered from the section orange color



EYES BASIC B PLUS



28,5 mm



- Incasso con anello di finitura in ottone cromato.
- Fissaggio tramite ghiera per controsoffitti accessibili o molla per controsoffitti non accessibili.
- Recessed fitting with ring made of chromed brass.
- Fixing by lock nut for accessible false-ceilings or retain spring for inaccessible false-ceilings.

	W	(lm)	V	K	(CRI)
CON GHIERA DI BLOCCAGGIO PER CONTROSOFFITTI ACCESSIBILI - WITH LOCK NUT FOR ACCESSIBLE FALSE-CEILINGS					
Cr	E894-G-LBC	4,2W	540	350mA	3000
	E894-G-LBN				
Cr	E897-G-LBC	4,2W	540	350mA	3000
	E897-G-LBN				

ALIMENTATORI CONSIGLIATI - RECOMMENDED DRIVERS					
644758	ON-OFF	6W	IP20	350mA	
644759-1	ON-OFF	15W	IP20	350mA	
646258-67	ON-OFF	13W	IP67	350mA	

K I T APPARECCHIO + ALIMENTATORE - FITTING + DRIVER

CON GHIERA DI BLOCCAGGIO PER CONTROSOFFITTI ACCESSIBILI - WITH LOCK NUT FOR ACCESSIBLE FALSE-CEILINGS					
Cr	KTE894-G-LBC	4,2W	540	220-240V (350mA)	3000
	KTE894-G-LBN				
Cr	KTE897-G-LBC	4,2W	540	220-240V (350mA)	3000
	KTE897-G-LBN				

CON MOLLA DI BLOCCAGGIO PER CONTROSOFFITTI NON ACCESSIBILI - WITH LOCK SPRING FOR UNACCESSIBLE FALSE-CEILINGS					
Cr	E894-M-LBC	4,2W	540	350mA	3000
	E894-M-LBN				
Cr	E897-M-LBC	4,2W	540	350mA	3000
	E897-M-LBN				

ALIMENTATORI CONSIGLIATI - RECOMMENDED DRIVERS					
644758	ON-OFF	6W	IP20	350mA	
644759-1	ON-OFF	15W	IP20	350mA	
646258-67	ON-OFF	13W	IP67	350mA	

K I T APPARECCHIO + ALIMENTATORE - FITTING + DRIVER

CON MOLLA DI BLOCCAGGIO PER CONTROSOFFITTI NON ACCESSIBILI - WITH LOCK SPRING FOR UNACCESSIBLE FALSE-CEILINGS					
Cr	KTE894-M-LBC	4,2W	540	220-240V (350mA)	3000
	KTE894-M-LBN				
Cr	KTE897-M-LBC	4,2W	540	220-240V (350mA)	3000
	KTE897-M-LBN				

OP. A richiesta - On request: disponibile - available

ACC. 186-3 Puzetto per pareti solide per Eyes Basic B - B-1 - B-3
Concrete walls pit for Eyes Basic B - B-1 - B-3

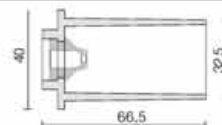

*Solo apparecchio - Only fitting



ALIMENTATORI-KIT RGB (se non in dotazione) da ordinare dalla sezione arancio - DRIVERS-RGB KITS (when not supplied) to be ordered from the section orange color





EYES A-1

- Incasso con anello di finitura in ottone cromato.
- Fissaggio tramite ghiera per controsoffitti accessibili o molla per controsoffitti non accessibili.
- Profondità d'installazione 1 m. max.
- Recessed fitting with ring made of chromed brass.
- Fixing by lock nut for accessible false-ceilings or retain spring for inaccessible false-ceilings.
- 1 m. max depth.



17 mm

	W	lm	V	K	CRI
--	---	----	---	---	-----

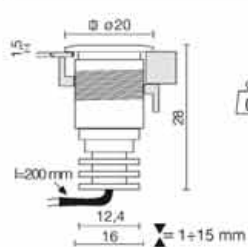

CON GHIERA DI BLOCCAGGIO PER CONTROSOFFITTI ACCESSIBILI - WITH LOCK NUT FOR ACCESSIBLE FALSE-CEILINGS

	Cr E881-G-LBC68 E881-G-LBN68	1x12W	120 125	350mA	3000 4000	>90
		Cr E881-GQ-LBC68 E881-GQ-LBN68	1x12W	120 125	350mA	3000 4000

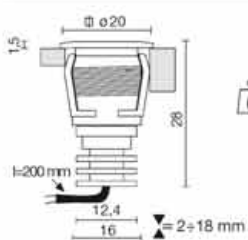

CON MOLLA DI BLOCCAGGIO PER CONTROSOFFITTI NON ACCESSIBILI - WITH LOCK SPRING FOR UNACCESSIBLE FALSE-CEILING

	Cr E881-M-LBC68 E881-M-LBN68	1x12W	125 130	350mA	4000 6000	>90
		Cr E881-MQ-LBC68 E881-MQ-LBN68	1x12W	125 130	350mA	4000 6000

ALIMENTATORI CONSIGLIATI - RECOMMENDED DRIVERS

644758	ON-OFF	6W	IP20	350mA
644759-1	ON-OFF	15W	IP20	350mA
646258-67	ON-OFF	13W	IP67	350mA

OP. Disponibile alimentatore in emergenza - Safety driver available
 E...LBL = LED blu-blue

ACC. 186-5 Pozzetto per pareti solide per Eyes Basic A - A-1
 Concrete walls pit for Eyes Basic A - A-1

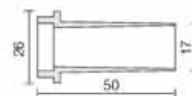

outside

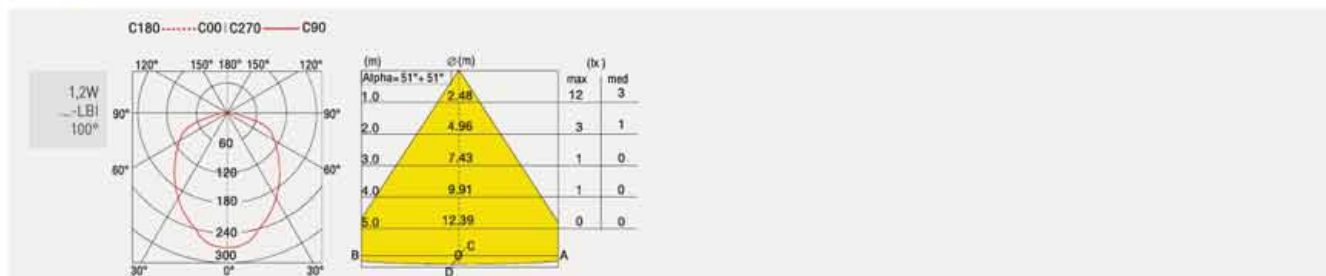

ALIMENTATORI-KIT RGB (se non in dotazione) da ordinare dalla sezione arancio - DRIVERS-RGB KITS (when not supplied) to be ordered from the section orange color



*Solo apparecchio - Only fitting









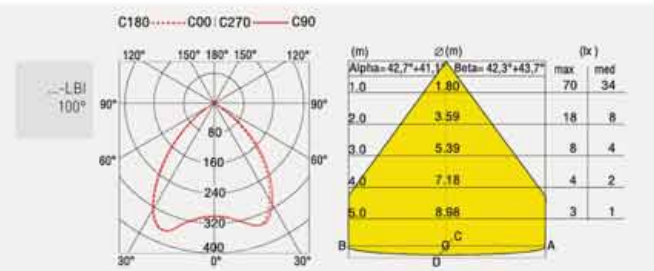
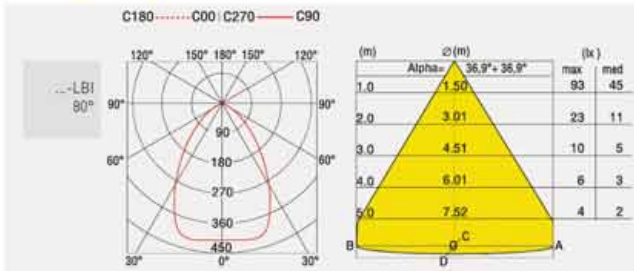

outside



ALIMENTATORI-KIT RGB (se non in dotazione) da ordinare dalla sezione arancio - DRIVERS-RGB KITS (when not supplied) to be ordered from the section orange color

EYES B-1



- Incasso con anello di finitura in ottone cromato.
- Fissaggio tramite ghiera per controsoffitti accessibili o molla per controsoffitti non accessibili.
- Recessed fitting with ring made of chromed brass.
- Fixing by lock nut for accessible false-ceilings or retain spring for inaccessible false-ceilings.



28 mm

Con lente bombata in vetro
With dished glass lens

Con vetro di protezione Led
With Led protection glass

		W	lm	V	K	CRI
CON GHIERA DI BLOCCAGGIO PER CONTROSOFFITTI ACCESSIBILI - WITH LOCK NUT FOR ACCESSIBLE FALSE-CEILINGS						
Cr	E885-G-LBC	E886-G-LBC	1x1,2W	130 - 165	500mA	3000
	E885-G-LBI	E886-G-LBI				6000
	E885-G-LBL	E886-G-LBL				470 nm
Cr	E885-G-RGB	E886-G-RGB	1x3,5W	-	350mA	-
Cr	E885-G-Q-LBC	E886-G-Q-LBC	1x2W	130 - 165	500mA	3000
	E885-G-Q-LBI	E886-G-Q-LBI				6000
	E885-G-Q-LBL	E886-G-Q-LBL				470 nm
Cr	E885-G-Q-RGB	E886-G-Q-RGB	1x3,5W	-	350mA	-
ALIMENTATORI CONSIGLIATI - RECOMMENDED DRIVERS						
644758	ON-OFF	8W	IP20	350mA		
644759-1	ON-OFF	15W	IP20	350mA		
646258-67	ON-OFF	13W	IP67	350mA		
644758-5	ON-OFF	6W	IP20	500mA		
645086	ON-OFF	20W	IP20	500mA		
645626-1	ON-OFF	20W	IP67	500mA		

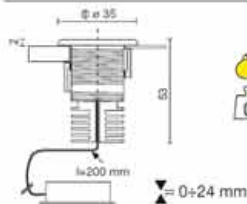

5kg
0,08

K I T APPARECCHIO - ALIMENTATORE - FITTING - DRIVER

CON GHIERA DI BLOCCAGGIO PER CONTROSOFFITTI ACCESSIBILI - WITH LOCK NUT FOR ACCESSIBLE FALSE-CEILINGS

Cr	KTE885-G-LBC	KTE886-G-LBC	3W	125	220-240V	3000
	KTE885-G-LBI	KTE886-G-LBI				6000
	KTE885-G-LBL	KTE886-G-LBL				470 nm

5kg
0,25

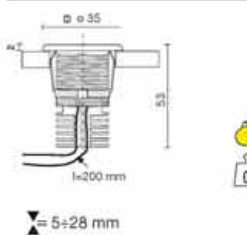

5kg
0,08

CON MOLLA DI BLOCCAGGIO PER CONTROSOFFITTI NON ACCESSIBILI - WITH LOCK SPRING FOR UNACCESSIBLE FALSE-CEILINGS

Cr	E885-M-LBC	E886-M-LBC	1x1,2W	130 - 165	500mA	3000
	E885-M-LBI	E886-M-LBI				6000
	E885-M-LBL	E886-M-LBL				470 nm

5kg
0,08

Cr	E885-M-Q-LBC	E886-M-Q-LBC	1x1,2W	130 - 165	500mA	3000
	E885-M-Q-LBI	E886-M-Q-LBI				6000
	E885-M-Q-LBL	E886-M-Q-LBL				470 nm

5kg
0,08

Cr	E885-M-Q-RGB	E886-M-Q-RGB	1x3,5W	-	350mA	-
----	--------------	--------------	--------	---	-------	---

ALIMENTATORI CONSIGLIATI - RECOMMENDED DRIVERS

644758	ON-OFF	8W	IP20	350mA		
644759-1	ON-OFF	15W	IP20	350mA		
646258-67	ON-OFF	13W	IP67	350mA		
644758-5	ON-OFF	6W	IP20	500mA		
645086	ON-OFF	20W	IP20	500mA		
645626-1	ON-OFF	20W	IP67	500mA		

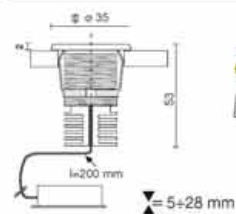

5kg
0,25

K I T APPARECCHIO - ALIMENTATORE - FITTING - DRIVER

CON MOLLA DI BLOCCAGGIO PER CONTROSOFFITTI NON ACCESSIBILI - WITH LOCK SPRING FOR UNACCESSIBLE FALSE-CEILINGS

Cr	KTE885-M-LBC	KTE886-M-LBC	1x1,2W	165	500mA	3000
	KTE885-M-LBI	KTE886-M-LBI				6000
	KTE885-M-LBL	KTE886-M-LBL				470 nm

■ il parametro più basso si riferisce sempre alla potenza inferiore - The lowest value is always referred to the lowest watt.

OP: Disponibile alimentatore in emergenza - Safety driver available

A richiesta - On request: disponibile - available



ACC. 186-3 Pozzetto per pareti solide per Eyes Basic B - B-1 - B-3
Concrete walls pit for Eyes Basic B - B-1 - B-3

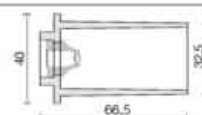

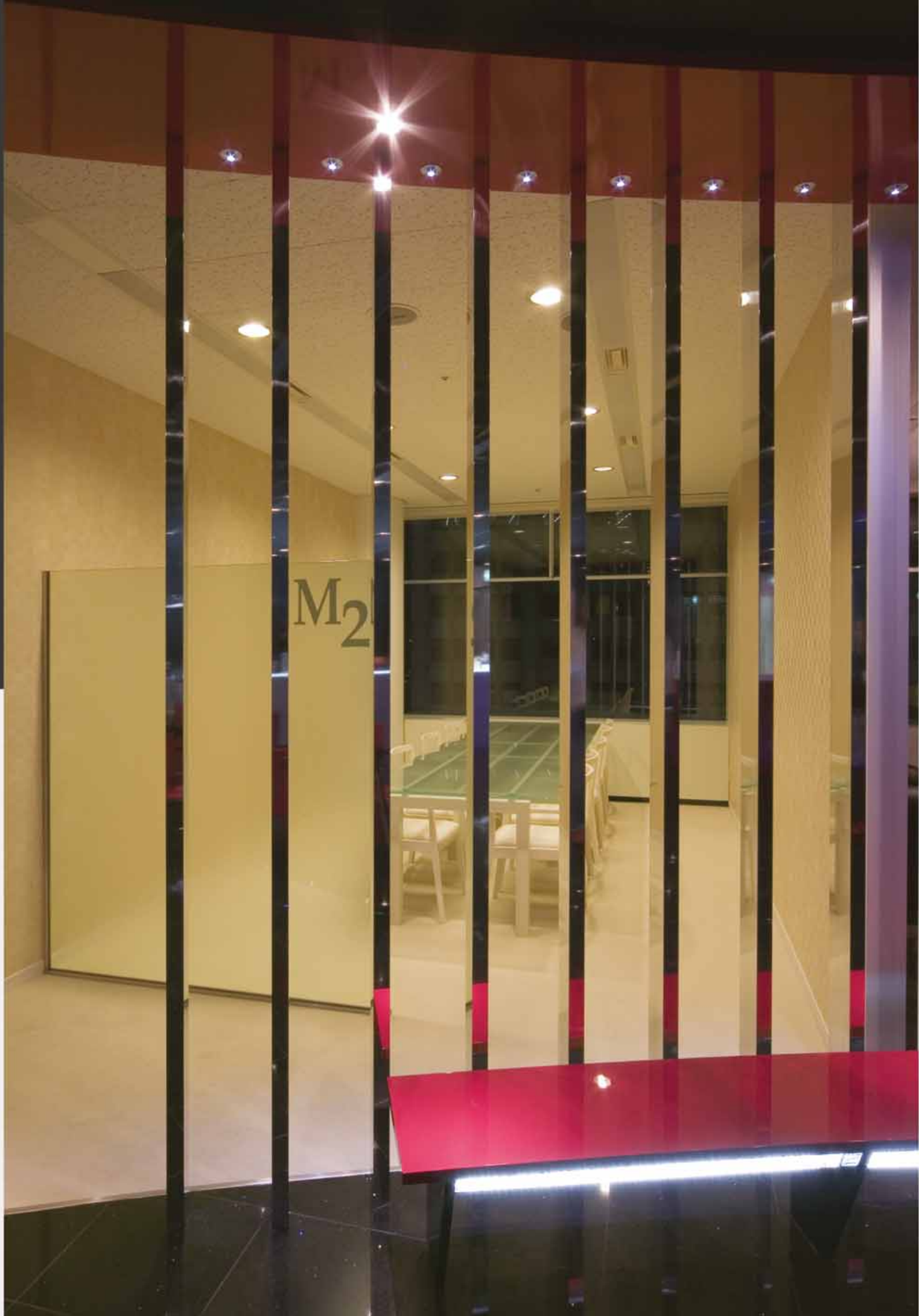

M2

EYES B-1 COB



28 mm

- Incasso con anello di finitura in ottone cromato con Led COB ad alta emissione.
- Parabola metallizzata.
- Fissaggio tramite ghiera per controsoffitti accessibili o molla per controsoffitti non accessibili.
- Recessed fitting with chromed brass ring and high emission COB Led.
- Metallized reflector.
- Fixing by lock nut for accessible false-ceilings or retain spring for inaccessible false-ceilings.

LED COB **W** **lm** **V** **K** **(CRI)**

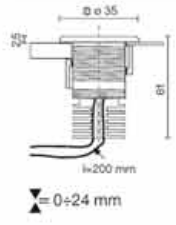

CON GHIERA DI BLOCCAGGIO PER CONTROSOFFITTI ACCESSIBILI - WITH LOCK NUT FOR ACCESSIBLE FALSE-CEILING

	Cr	E886-G-LBC-C E886-G-LBN-C	1x3,5W 380	350 380	350mA	3000 4000	>90
	Cr	E886-GQ-LBC-C E886-GQ-LBN-C	1x3,5W 380	350 380	350mA	3000 4000	>90

ALIMENTATORI CONSIGLIATI - RECOMMENDED DRIVERS

644758	ON-OFF	0W	IP20	350mA
644759-1	ON-OFF	15W	IP20	350mA
646258-67	ON-OFF	13W	IP67	350mA

KIT APPARECCHIO - ALIMENTATORE - FITTING - DRIVER

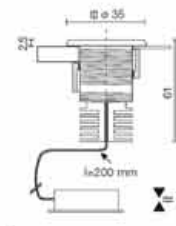

CON GHIERA DI BLOCCAGGIO PER CONTROSOFFITTI ACCESSIBILI - WITH LOCK NUT FOR ACCESSIBLE FALSE-CEILING

	Cr	KTE886G-LBC-C KTE886G-LBN-C	4,5W 380	350 380	220-240V [350mA]	3000 4000	>90
	Cr	KTE886GQ-LBC-C KTE886GQ-LBN-C	4,5W 380	350 380	220-240V [350mA]	3000 4000	>90

ALIMENTATORI CONSIGLIATI - RECOMMENDED DRIVERS

644758	ON-OFF	0W	IP20	350mA
644759-1	ON-OFF	15W	IP20	350mA
646258-67	ON-OFF	13W	IP67	350mA

KIT APPARECCHIO - ALIMENTATORE - FITTING - DRIVER

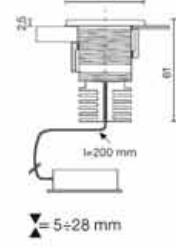

CON MOLLA DI BLOCCAGGIO PER CONTROSOFFITTI NON ACCESSIBILI - WITH LOCK SPRING FOR UNACCESSIBLE FALSE-CEILING

	Cr	E886-M-LBC-C E886-M-LBN-C	1x3,5W 380	350 380	350mA	3000 4000	>90
	Cr	E886-MQ-LBC-C E886-MQ-LBN-C	1x3,5W 380	350 380	350mA	3000 4000	>90

OP. A richiesta - On request: disponibile - available

ACC. 186-3 Pozzetto per pareti solide per Eyes Basic B - B-1 - B-3
Concrete walls pit for Eyes Basic B - B-1 - B-3

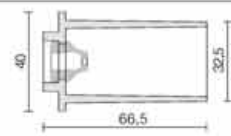

*Solo apparecchio - Only fitting

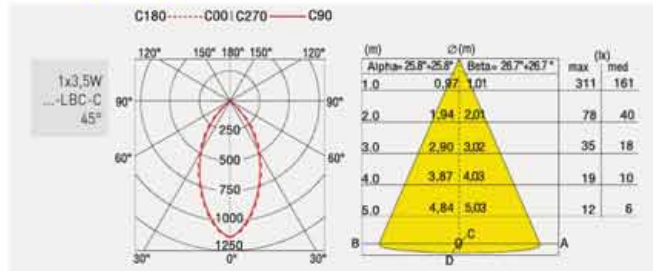

ALIMENTATORI-KIT RGB (se non in dotazione) da ordinare dalla sezione arancio - DRIVERS-RGB KITS (when not supplied) to be ordered from the section orange color

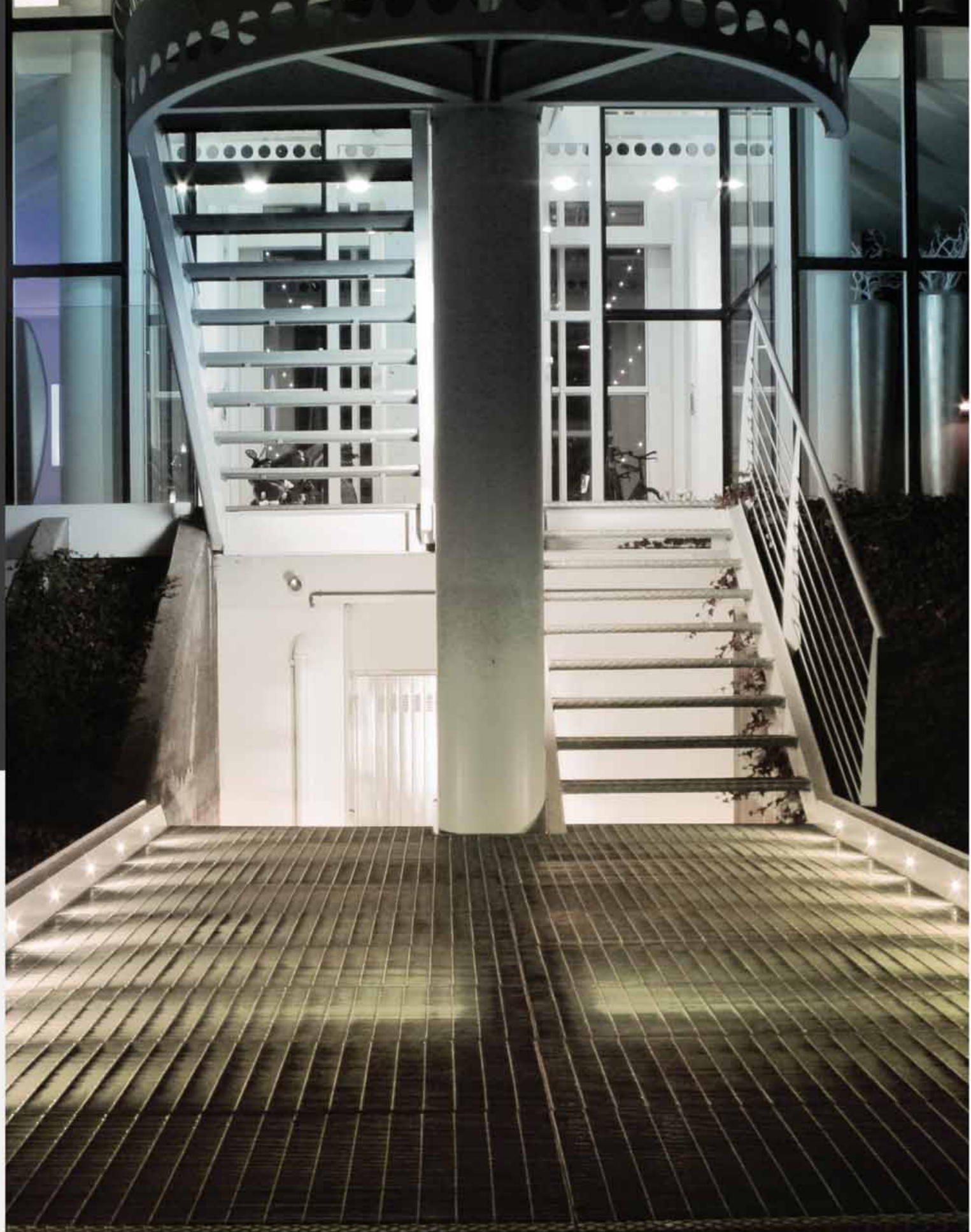



EYES WALL FLAT COB



- Incasso in ottone cromato con Led ad alta emissione.
 - Anello di finitura in acciaio Inox (AISI 316).
 - Parabola metallizzata (solo COB) e vetro di protezione.
 - Apparecchio da incasso a parete.
- Recessed fitting made of chromed brass provided with high emission Led.
 - Finishing stainless steel ring (AISI 316).
 - Metalized reflector (only COB) and protection glass.
 - Wall mounting recessed fixture.

28 mm

LED COB	W	lm	V	K	CRI
---------	---	----	---	---	-----

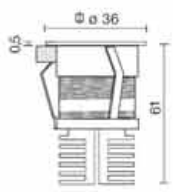

INCASSO PER PARETI SOLIDE - SUITABLE FOR CONCRETE WALLS						
Inox	E871-M-LBC-C	1x3,5W	285	350mA	3000	>90
	E871-M-LBN-C		300		4000	
Inox	E871-MQ-LBC-C	1x3,5W	285	350mA	3000	>90
	E871-MQ-LBN-C		300		4000	

ALIMENTATORI CONSIGLIATI - RECOMMENDED DRIVERS

644758	ON-OFF	6W	IP20	350mA
644759-1	ON-OFF	15W	IP20	350mA
646258-67	ON-OFF	13W	IP67	350mA

OP. Disponibile alimentatore in emergenza - Safety driver available
Solo per sorgenti NON COB - Only for NON COB sources

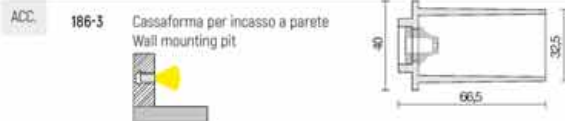

outside

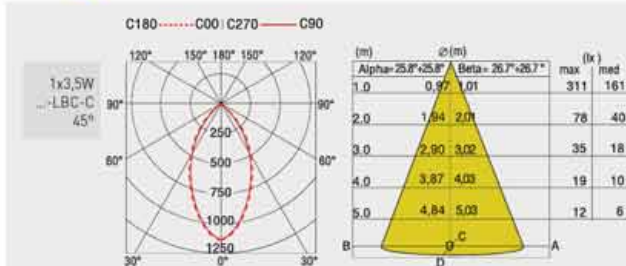

ALIMENTATORI-KIT RGB (se non in dotazione) da ordinare dalla sezione arancio - DRIVERS-RGB KITS (when not supplied) to be ordered from the section orange color



EYES C



- Corpo e componenti orientabili in alluminio anodizzato orientabile.
- Anello di finitura in alluminio anodizzato.
- Aggancio a molla.
- Adjustable body and mechanical elements made of anodized aluminium.
- Ring made of anodized aluminium.
- Spring locking.



	(W)	(lm)	(V)	(K)	(CRI)
OTTICHE FLOOD - FLOOD BEAMS					
E931-LBC		240		3000	
Als E931-LBI	3x12W	300	350mA	6000	>90
E931-LBL		-		470nm	
OTTICHE SPOT - SPOT BEAMS					
E934-LBC		130		3000	
Als E934-LBI	1x2W	150	500mA	6000	>90
E934-LBL		-		470nm	
Als E933-LBC	1x3.5W	-	350mA		
E933-LBI					
E933-LBL					
Als E935-LBC	1x2W	130	500mA	3000	
E935-LBI		150		6000	>90
E935-LBL		-		470nm	

ALIMENTATORI CONSIGLIATI - RECOMMENDED DRIVERS

644758	ON-OFF	6W	IP20	350mA
644759-1	ON-OFF	15W	IP20	350mA
646258-67	ON-OFF	13W	IP67	350mA
644758-5	ON-OFF	6W	IP20	500mA
645086	ON-OFF	20W	IP20	500mA
645626-1	ON-OFF	20W	IP67	500mA

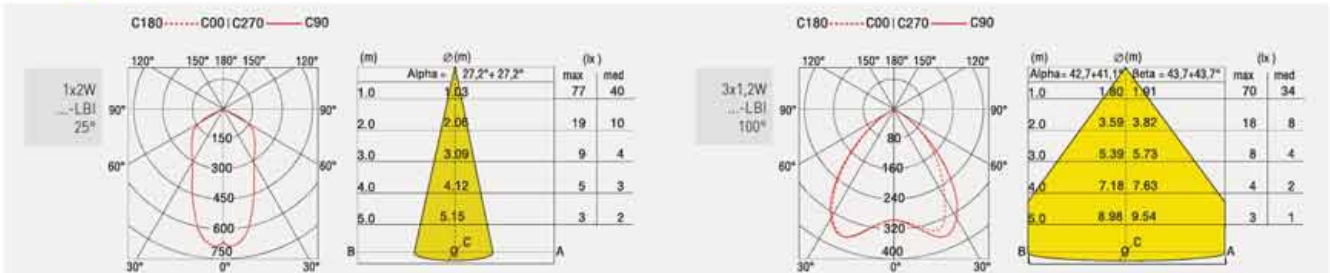

ALIMENTATORI-KIT RGB (se non in dotazione) da ordinare dalla sezione arancio - DRIVERS-RGB KITS (when not supplied) to be ordered from the section orange color



*Solo apparecchio - Only fitting

IP 65

outside

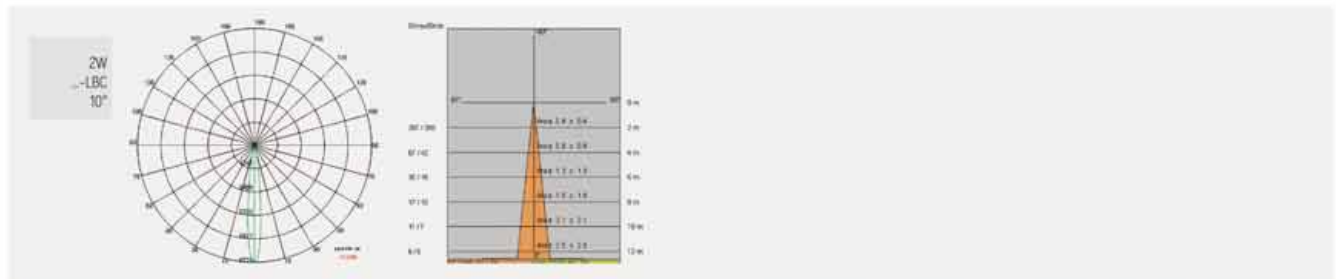

ALIMENTATORI-KIT RGB (se non in dotazione) da ordinare dalla sezione arancio - DRIVERS-RGB KITS (when not supplied) to be ordered from the section orange color

EYES ORIENTABILE



- Corpo in alluminio verniciato o alluminio anodizzato.
- Lente secondaria in PMMA.
- Led durata utile: 50.000 [h] L90 B20.
- Consistenza cromatica: 3 SDCM,

- Body in painted or anodised aluminum.
- Secondary lens in PMMA.
- Led life: 50.000 [h] L90 B20.
- Chromatic consistency: 3 SDCM.



34 mm Δ 1+30 mm



	Br	E1219-LBC	E1221-LBC	2W	150	500mA	3000	>90
	Ne	E1220-LBC	E1222-LBC					
	Als	E1223-LBC	E1224-LBC					
	Br	E1219-LBN	E1221-LBN	2W	160	500mA	4000	>90
	Ne	E1220-LBN	E1222-LBN					
	Als	E1223-LBN	E1224-LBN					

ALIMENTATORI CONSIGLIATI - RECOMMENDED DRIVERS						
644758-5	ON-OFF	6W	IP20	500mA	2 apparecchi - fittings	
645496	ON-OFF	10W	IP40	500mA	4 apparecchi - fittings	
645086	ON-OFF	20W	IP20	500mA	8 apparecchi - fittings	
645626-1	ON-OFF	26W	IP67	500mA		



K I T 2 APPARECCHI + ALIMENTATORE - 2 FITTINGS + DRIVER								
	Br	KT-E1219LBC-2	KT-E1221LBC-2	2W	150	220-240V (500mA)	3000	>90
	Ne	KT-E1220LBC-2	KT-E1222LBC-2					
	Als	KT-E1223LBC-2	KT-E1224LBC-2					
	Br	KT-E1219LBN-2	KT-E1221LBN-2	2W	160	220-240V (500mA)	4000	>90
	Ne	KT-E1220LBN-2	KT-E1222LBN-2					
	Als	KT-E1223LBN-2	KT-E1224LBN-2					

K I T 4 APPARECCHI + ALIMENTATORE - 4 FITTINGS + DRIVER								
	Br	KT-E1219LBC-4	KT-E1221LBC-4	2W	150	220-240V (500mA)	3000	>90
	Ne	KT-E1220LBC-4	KT-E1222LBC-4					
	Als	KT-E1223LBC-4	KT-E1224LBC-4					
	Br	KT-E1219LBN-4	KT-E1221LBN-4	2W	160	220-240V (500mA)	4000	>90
	Ne	KT-E1220LBN-4	KT-E1222LBN-4					
	Als	KT-E1223LBN-4	KT-E1224LBN-4					

K I T 8 APPARECCHI + ALIMENTATORE - 8 FITTINGS + DRIVER								
	Br	KT-E1219LBC-8	KT-E1221LBC-8	2W	150	220-240V (500mA)	3000	>90
	Ne	KT-E1220LBC-8	KT-E1222LBC-8					
	Als	KT-E1223LBC-8	KT-E1224LBC-8					
	Br	KT-E1219LBN-8	KT-E1221LBN-8	2W	160	220-240V (500mA)	4000	>90
	Ne	KT-E1220LBN-8	KT-E1222LBN-8					
	Als	KT-E1223LBN-8	KT-E1224LBN-8					

ESEMPIO - EXAMPLE

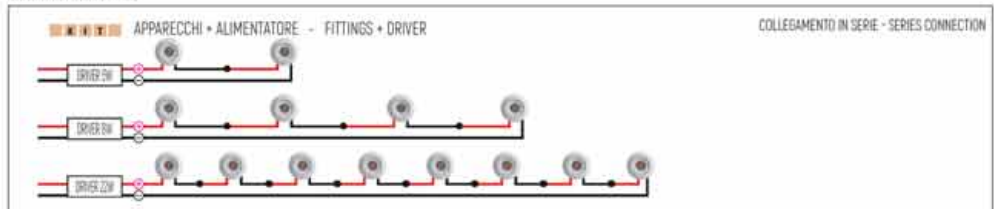



CIELO 3 LED

- Corpo in pressofusione di alluminio verniciato in polveri con pretrattamento per esterni.
- Dissipatore in alluminio.
- Anello in materiale termoplastico.
- Lente protezione Led in metacrilato.
- Molle in acciaio e schermo di protezione in vetro temperato.

- Body with special powder die-cast aluminium treatment for outdoor use.
- Aluminium heatsink.
- Thermoplastic material ring.
- Methacrylate Led protection lens.
- Steel springs and tempered glass protection glass.



70 mm Δ = 1+20 mm

	Kg 0,30	BI	E8140-RGB-10	E8140-RGB-30	E8140-RGB-45	LED					SISTEMA-SYSTEM				
						W	lm	V	K	CRI	W	lm	W		
		Ne	E8141-RGB-10	E8141-RGB-30	E8141-RGB-45	3x1,2W	-	350mA		-	-	-	-	-	-
		GI	E8142-RGB-10	E8142-RGB-30	E8142-RGB-45										

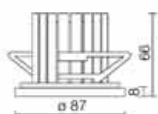

ACC. 148 per installazioni in calcestruzzo
for concrete ceilings installations

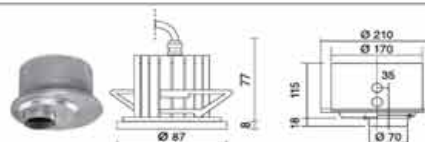

Solo per sorgente LED: versione speciale predisposta per cassaforma idonea ad installazioni in calcestruzzo.

Esempio di ordinazione: **E8140C-LBC-10** (aggiungere la C dopo il numero articolo e completare il codice) - ordinare cassaforma art. 148.

Only for LED source: special version for housing suitable for concrete ceiling installations.

Ordering example: **E8140C-LBC-10** [insert the C letter immediately after the code number and then complete the code] - order housing art. 148.

IP 65



outside



CIELO COB



70 mm 1+20 mm

- Corpo in pressofusione di alluminio verniciato in polveri con pretrattamento per esterni.
- Anello in materiale termoplastico.
- Lente protezione Led in metacrilato.
- Molle in acciaio e schermo di protezione in vetro temperato.
- Body with special powder die-cast aluminium treatment for outdoor use.
- Thermoplastic material ring.
- Methacrylate Led protection lens.
- Steel springs and tempered glass protection glass.

LED COB	Eco	Eco 25	Eco 40	LED					SISTEMA-SYSTEM			
				W	lm	V	K	CRI	W	lm	W	°
Bi	E8140-MLBC-25	E8140-MLBC-40		5,2W	700	150mA	3000	>90	5,2W	673	139	[25°]
Ne	E8141-MLBC-25	E8141-MLBC-40								667	128	[40°]
Gi	E8142-MLBC-25	E8142-MLBC-40										
Bi	E8140-MLBN-25	E8140-MLBN-40		5,2W	660	150mA	4000	>90	5,2W	635	104	[25°]
Ne	E8141-MLBN-25	E8141-MLBN-40								630	103	[40°]
Gi	E8142-MLBN-25	E8142-MLBN-40										

ALIMENTATORI CONSIGLIATI - RECOMMENDED DRIVERS
646209 ON-OFF 5W IP20 150mA

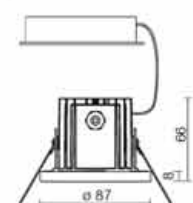
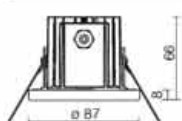

KIT		APPARECCHIO + ALIMENTATORE FITTING + DRIVER										
Bi	KTE8140MLBC25	KTE8140MLBC40		5,2W	700	220-240V [150mA]	3000	>90	6,2W	673	109	[25°]
Ne	KTE8141MLBC25	KTE8141MLBC40								667	108	[40°]
Gi	KTE8142MLBC25	KTE8142MLBC40										
Bi	KTE8140MLBN25	KTE8140MLBN40		5,2W	660	220-240V [150mA]	4000	>90	6,2W	635	89	[25°]
Ne	KTE8141MLBN25	KTE8141MLBN40								630	88	[40°]
Gi	KTE8142MLBN25	KTE8142MLBN40										

ACC. 148 per installazioni in calcestruzzo for concrete ceilings installations

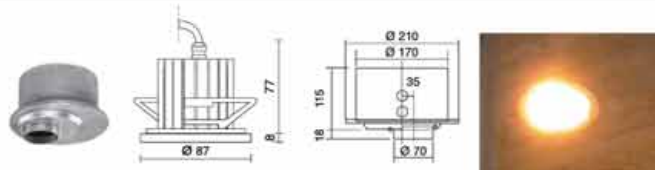

Solo per sorgente LED: versione speciale predisposta per cassaforma idonea ad installazioni in calcestruzzo.
Esempio di ordinazione: **E8140C-MLBC-10** [aggiungere la C dopo il numero articolo e completare il codice] + ordinare cassaforma art. 148.
Only for LED source: special version for housing suitable for concrete ceiling installations.
Ordering example: **E8140C-MLBC-10** [insert the C letter immediately after the code number and then complete the code] + order housing art. 148.

*Solo apparecchio - Only fitting



outside

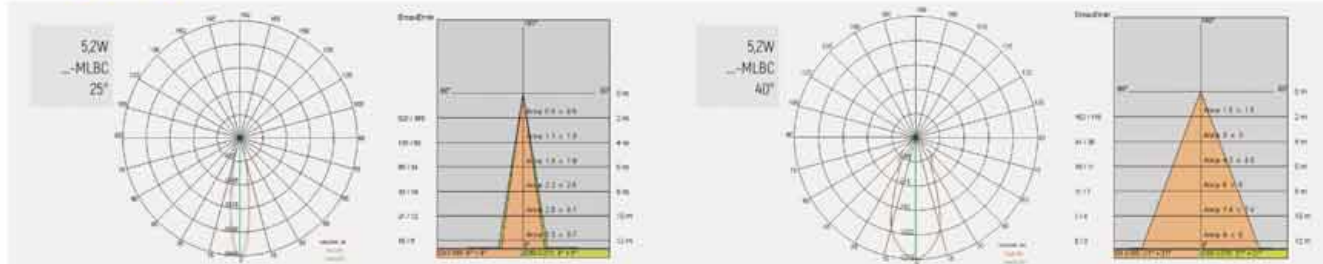

ALIMENTATORI-KIT RGB (se non in dotazione) da ordinare dalla sezione arancio - DRIVERS-RGB KITS (when not supplied) to be ordered from the section orange color



OLODUM MICRO C COB



61 mm Δ 5+30 mm



- Apparecchi da incasso per controsoffitto.
- Corpo e anello di finitura in acciaio Inox [AISI 316].
- Guarnizione in gomma silconica.
- Vetro di protezione temperato trasparente.
- Pressacavo in ottone nichelato PG7.

- False-ceilings recessed downlights.
- Stainless steel [AISI 316] body and finishing trim.
- Silicon rubber gaskets.
- Tempered protection glass.
- PG7 nickel brass cable gland.

LED COB					(W)	(lm)	(V)	(K)	(CRI)
		Inox	E8494-LBC-I E8494-LBN-I	45	3,5W	350 380	350mA	3000 4000	>90
		Inox	E8494-LBC-Q-I E8494-LBN-Q-I	45	3,5W	350 380	350mA	3000 4000	>90

KIT		APPARECCHIO + ALIMENTATORE - FITTING + DRIVER							
		Inox	KTE8494-LBC-I KTE8494-LBN-I	45	3,5W	350 380	220-240V [350mA]	3000 4000	>90
		Inox	KTE8494LBC-QI KTE8494LBN-QI	45	3,5W	350 380	220-240V [350mA]	3000 4000	>90

ACC. 646308 Connettore IP68 ϕ da 7 a 12mm - IP68 connector ϕ from 7 to 12mm

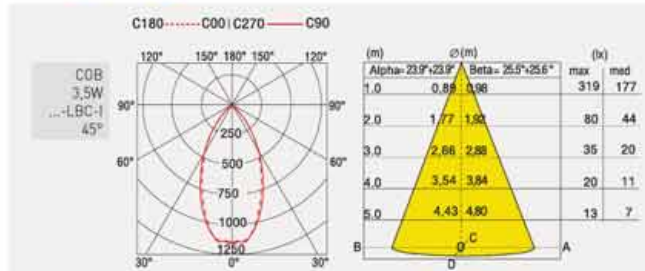

ALIMENTATORI-KIT RGB (se non in dotazione) da ordinare dalla sezione arancio - DRIVERS-RGB KITS (when not supplied) to be ordered from the section orange color



OLODUM MINI C COB



- Apparecchi da incasso per controsoffitto.
- Corpo in pressofusione di alluminio, verniciato in polveri con pretrattamento speciale per esterni.
- Anello di finitura in acciaio Inox (AISI 316).
- Vetro di protezione temperato trasparente.
- Pressacavo in ottone nichelato PG11.
- False-ceilings recessed downlights.
- Spot made of die-cast aluminium, powder coated with pretreatment for outdoor use.
- Stainless steel (AISI 316) frame.
- Tempered protection glass.
- PG11 cable gland of nickel plated brass.



120 mm Δ = 5+25 mm

LED COB + DRIVER IP67	LED	SISTEMA-SYSTEM		
		W	lm	lm/W
Incox E8185CI-LBC15 E8185CI-LBC24 E8185CI-LBC40	12,3W 1040	14,3W	896	62
	12,9W 1430	14,9W	1207	81
	12,9W 1360	14,9W	1136	76
Incox E8185CI-LBN15 E8185CI-LBN24 E8185CI-LBN40	12,3W 1120	14,3W	965	67
	12,9W 1510	14,3W	2274	86
	12,9W 1630	14,3W	1194	80

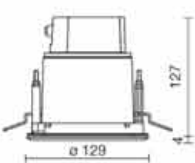
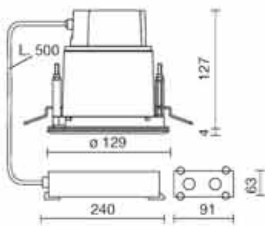

LED	W	lm	lm/W
Incox E8185-I-RGB10 E8185-I-RGB30 E8185-I-RGB45	3x12W	350mA	-

ACC. 546308	Connettore IP68 ϕ da 7 a 12mm - IP68 connector ϕ from 7 to 12mm	
E960	Ventosa per rimuovere vetro - Glass remover	

*Solo apparecchio - Only fitting

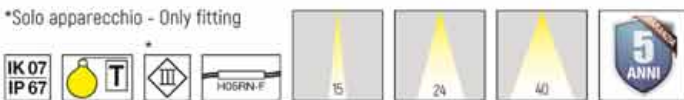

outside

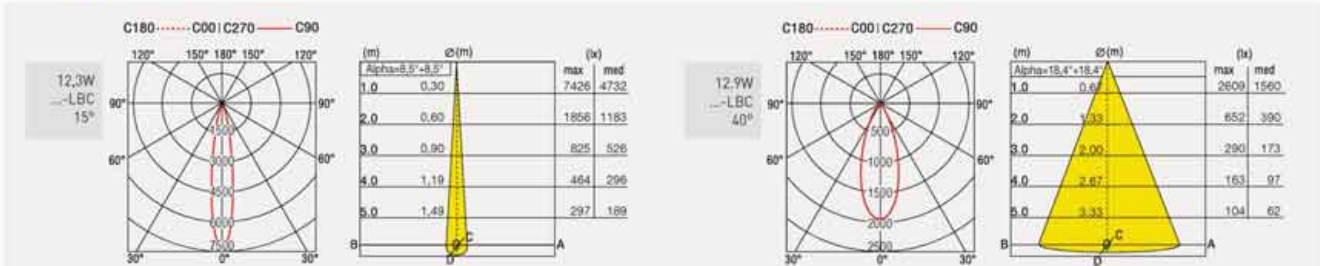

ALIMENTATORI-KIT RGB (se non in dotazione) da ordinare dalla sezione arancio - DRIVERS-RGB KITS (when not supplied) to be ordered from the section orange color

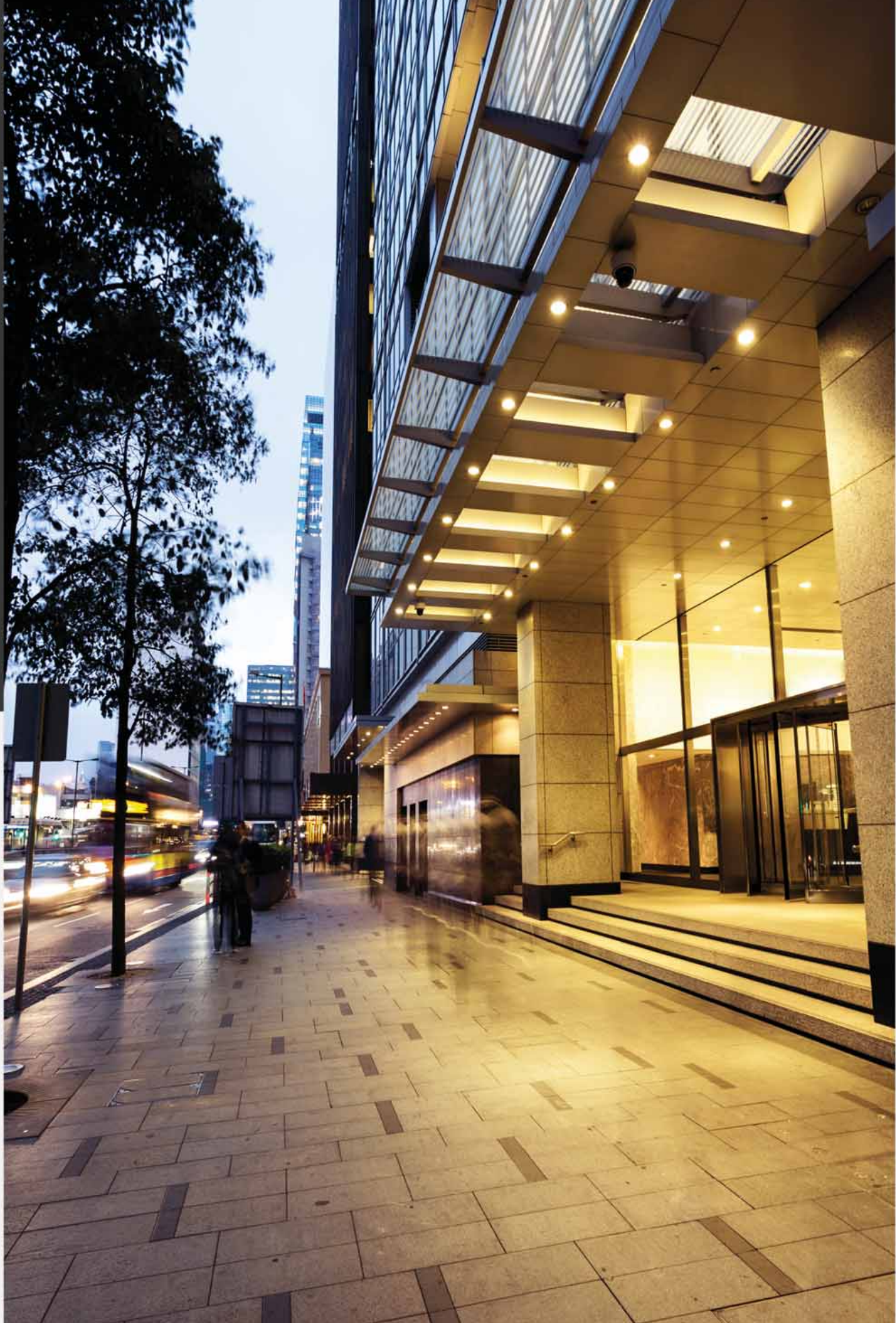

OLODUM MIDI C COB



- Apparecchi da incasso per controsoffitto.
- Corpo in pressofusione di alluminio, verniciato in polveri con pretrattamento speciale per esterni.
- Anello di finitura in acciaio Inox (AISI 316).
- Vetro di protezione temperato trasparente.
- Pressacavo in ottone nichelato PG13,5.
- False-ceilings recessed downlights.
- Spot made of die-cast aluminium, powder coated with pretreatment for outdoor use.
- Stainless steel (AISI 316) frame.
- Tempered protection glass.
- PG13,5 cable gland of nickel plated brass.



162 mm $\Delta = 1 \pm 30$ mm

LED COB	LED	SISTEMA-SYSTEM											
		W	lm	V	K	CRI	W	lm	W				
LUCE SIMMETRICA - SYMMETRIC LIGHT E82711-LBC-S SPOT $\Delta 15^\circ$ E82711-LBC-FL FLOOD $\Delta 30^\circ$ E82711-LBC-WF WIDE FLOOD $\Delta 40^\circ$	8,5W	950	220-240V [250mA]	3000	>90	9,5W	780	82	746	79	760	80	
	LUCE ASIMMETRICA - ASYMMETRIC LIGHT E82711-LBN-S SPOT $\Delta 15^\circ$ E82711-LBN-FL FLOOD $\Delta 30^\circ$ E82711-LBN-WF WIDE FLOOD $\Delta 40^\circ$	8,5W	1000	220-240V [250mA]	4000	>90	9,5W	820	86	785	82	800	84
		E82711-LBC-AS $\Delta 15^\circ$ E82711-LBN-AS $\Delta 15^\circ$	8,5W	950	220-240V [250mA]	3000	>90	9,5W	680	71	9,5W	715	75
8,5W			1000	220-240V [250mA]	4000	>90	9,5W	820	86	785	82	800	84

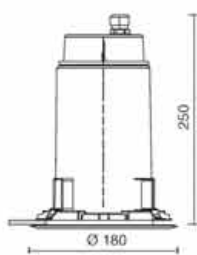

ACC. **646308** Connettore IP68 ϕ da 7 a 12mm - IP68 connector ϕ from 7 to 12mm
E960 Ventosa per rimuovere vetro - Glass remover 30,00
 A richiesta: versione in emergenza aggiungendo il Kit - On request: emergency version adding Kit
INV 1052 KIT 1h IP20
INV 1052-3 KIT 3h IP20

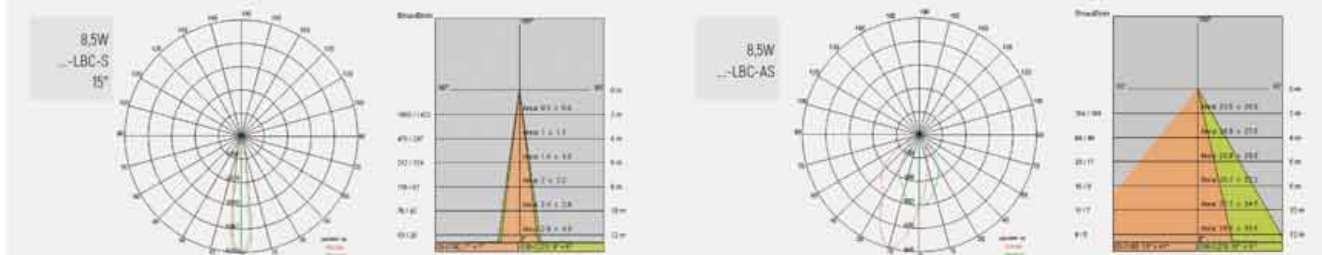

ALIMENTATORI-KIT RGB (se non in dotazione) da ordinare dalla sezione arancio - DRIVERS-RGB KITS (when not supplied) to be ordered from the section orange color





OLODUM STANDARD C COB

- Apparecchi da incasso per controsoffitto.
- Corpo in pressofusione di alluminio, verniciato in polveri con pretrattamento speciale per esterni.
- Anello di finitura in acciaio Inox (AISI 316).
- Vetro di protezione temperato trasparente.
- Pressacavo in ottone nichelato PG13,5.
- False-ceilings recessed downlights.
- Spot made of die-cast aluminium, powder coated with pretreatment for outdoor use.
- Stainless steel (AISI 316) frame.
- Tempered protection glass.
- PG13,5 cable gland of nickel plated brass.



201 mm Δ 5±50 mm

LED COB	LED	SISTEMA-SYSTEM									
		W	lm	V	K	CRI	W	lm	IP		
LUCE SIMMETRICA - SYMMETRIC LIGHT											
	Inox	E81281-LBC-S	SPOT	17W	2500	220-240V [500mA]	3000	>90	20W	2213	110
	Inox	E81281-LBC-FL	FLOOD	17W	2665	220-240V [500mA]	4000	>90	20W	2195	109
	Inox	E81281-LBC-WF	WIDE FLOOD	17W	2665	220-240V [500mA]	4000	>90	20W	1990	99
LUCE ASIMMETRICA - ASYMMETRIC LIGHT											
	Inox	E81281-LBN-S	SPOT	17W	2500	220-240V [500mA]	3000	>90	20W	2360	118
	Inox	E81281-LBN-FL	FLOOD	17W	2665	220-240V [500mA]	4000	>90	20W	2341	117
	Inox	E81281-LBN-WF	WIDE FLOOD	17W	2665	220-240V [500mA]	4000	>90	20W	2120	106
LUCE ASIMMETRICA - ASYMMETRIC LIGHT											
	Inox	E81281-LBC-AS		17W	2500	220-240V [500mA]	3000	>90	20W	1880	94
	Inox	E81281-LBN-AS		17W	2665	220-240V [500mA]	4000	>90	20W	2005	100

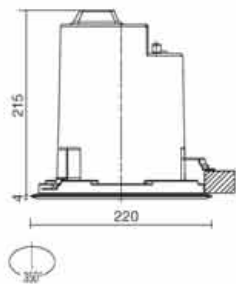

ACC. 646308 Connettore IP68 Ø da 7 a 12mm - IP68 connector Ø from 7 to 12mm
 E960 Ventosa per rimuovere vetro - Glass remover

A richiesta: versione in emergenza aggiungendo il Kit - On request: emergency version adding Kit

INV 1052 Kit 1h IP20
 INV 1052-3 KIT 3h IP20



outside

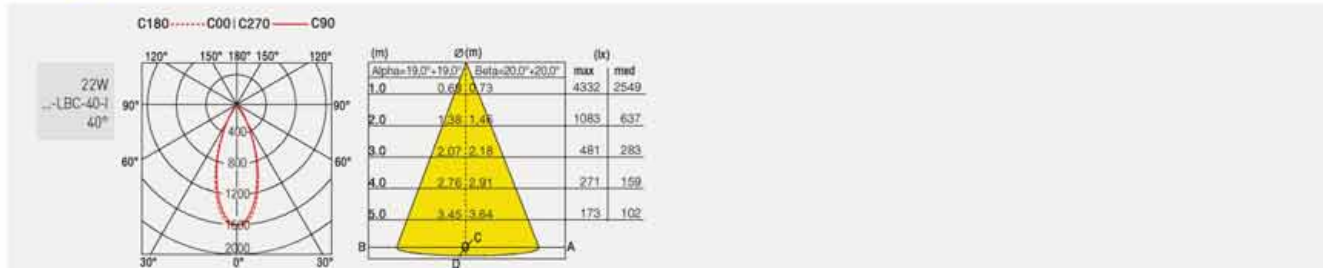

ALIMENTATORI-KIT RGB (se non in dotazione) da ordinare dalla sezione arancio - DRIVERS-RGB KITS (when not supplied) to be ordered from the section orange color





OLODUM STANDARD PROOF C COB

- Corpo in materiale polimerico.
 - Alta resistenza ambiente marino o ad alta salinità.
 - Anello di finitura in acciaio Inox (AISI 316L).
 - Pressacavo in ottone nichelato PG13,5.
 - Vetro temperato di spessore 10 mm.
- Body in polymeric material.
 - High resistance to marine and heavy salt environments.
 - Stainless steel (AISI 316L).
 - PG13,5 cable gland of nickel plated brass.
 - Tempered glass 10 mm thick.



201 mm Δ 5+50 mm

NUOVO MATERIALE TERMOPLASTICO SUPER RESISTENTE
NEW THERMOPLASTIC MATERIAL SUPER RESISTANT



LED COB	Icone	LED	SYSTEM-SYSTEM							
			W	lm	lm/W					
LUCE SIMMETRICA - SYMMETRIC LIGHT										
			W	lm	V	K	CRI	W	lm	lm/W
Inox	E8129I-LBC-S	SPOT						2213	110	
	E8129I-LBC-FL	FLOOD	17W	2500	220-240V [500mA]	3000	>90	2195	109	
	E8129I-LBC-WF	WIDE FLOOD						1990	99	
	E8129I-LBN-S	SPOT						2360	118	
Inox	E8129I-LBN-FL	FLOOD	17W	2665	220-240V [500mA]	4000	>90	2341	117	
	E8129I-LBN-WF	WIDE FLOOD						2120	106	
LUCE ASIMMETRICA - ASYMMETRIC LIGHT										
								1880	94	
Inox	E8129I-LBC-AS		17W	2500	220-240V [500mA]	3000	>90	2005	100	
	E8129I-LBN-AS									

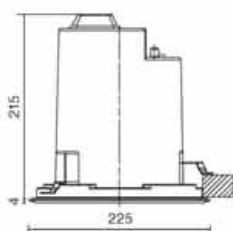

3,60



OP. ...TSC TORX Viti di sicurezza - Safety screws

ACC. 646308 Connettere IP68 \varnothing da 7 a 12mm - IP68 connector \varnothing from 7 to 12mm

E960 Ventosa per rimuovere vetro - Glass remover

A richiesta: versione in emergenza aggiungendo il Kit - On request: emergency version adding Kit

INV 1052 Kit 1h IP20

INV 1052-3 Kit 3h IP20

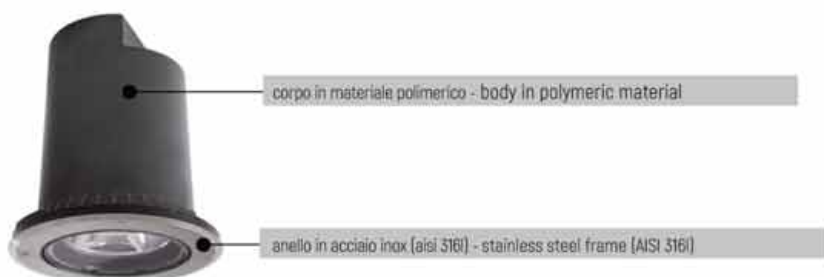

corpo in materiale polimerico - body in polymeric material

anello in acciaio inox (aisi 316l) - stainless steel frame (AISI 316l)



MODULO LED BASCULANTE $\pm 15^\circ$
LED MODULE ADJUSTABLE $\pm 15^\circ$



Anticorrosione per tutti gli apparecchi da esterno (1000 ore in nebbia salina secondo norma CEI EN 50058-2-11)

Anti-corrosion for all outdoor fittings (1000 hours in salt spray according to standard CEI EN 50058-2-11)

IK 10
IP 67



outside

ALIMENTATORI-KIT RGB (se non in dotazione) da ordinare dalla sezione arancio - DRIVERS-RGB KITS (when not supplied) to be ordered from the section orange color

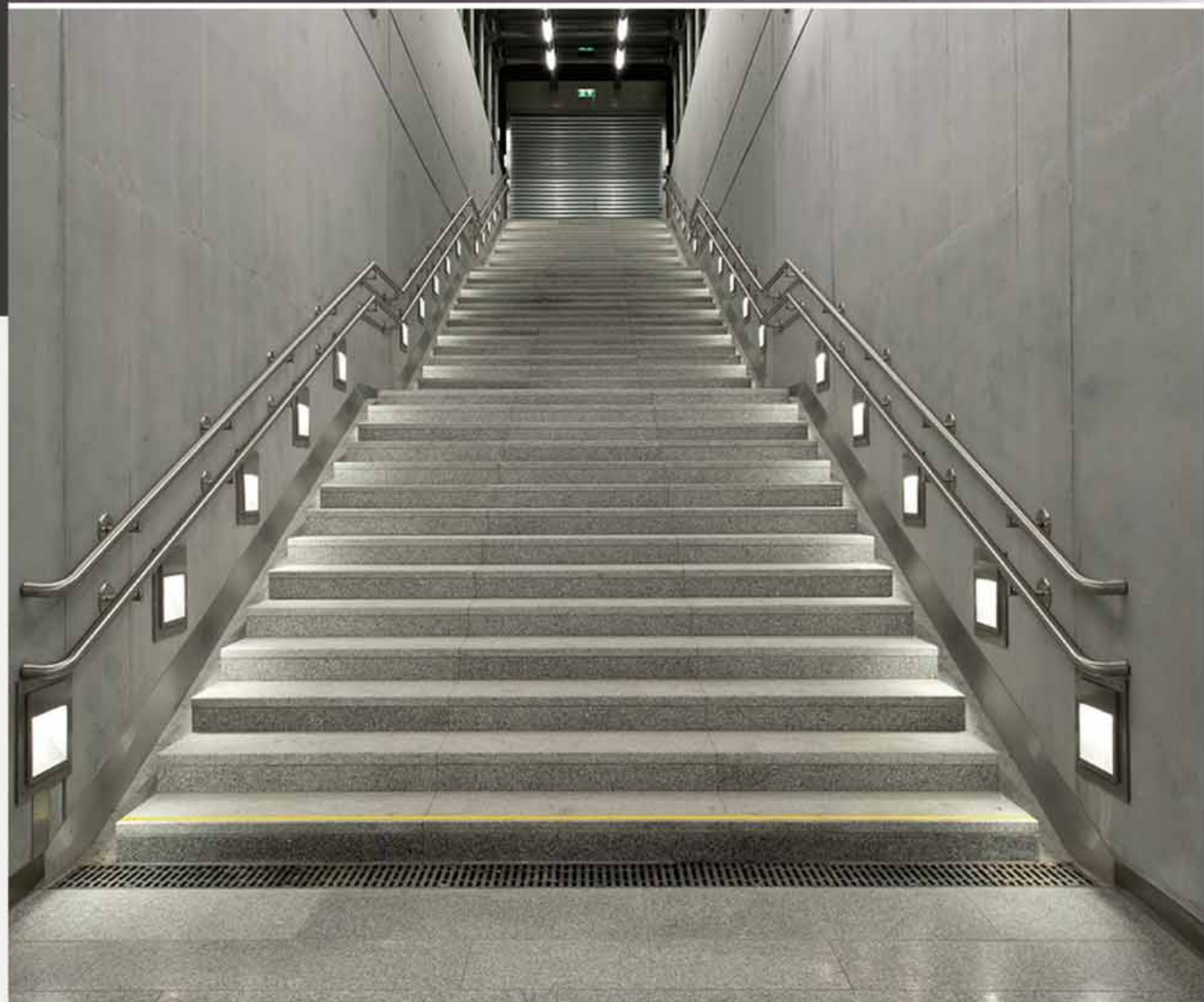



INCASSI A PARETE - SEGNAPASSO WALL RECESSED - STEP LIGHT

outside

• SEGNAPASSO – STEP LIGHT



**EYES
CORRIMANO**
483



EYES WALL
485



RING
487



**OLODUM MINI
PARETE**
489



**RIQUADRO
MICRO LED**
491



**RIQUADRO
MICRO LED**
493



NEW GREEN
494



JOGGER
499



APPLY MINI
500



APPLY 1-2
501



EYES BASIC CORRIMANO



- Incasso in acciaio Inox (AISI 316L).
- Aggancio a molla.
- Recessed fitting Inox steel (AISI 316L).
- Spring locking.

	CORRIMANO - HANDRAILS	LED					SISTEMA-SYSTEM		
		W	lm	V	K	CRI	W	lm	lm/W
	E901-M-LBC E901-M-LBN	2W	145	500mA	3000	>90	1,2W	100	50
	Inox	155	4000				1,2W	105	52

ALIMENTATORI CONSIGLIATI - RECOMMENDED DRIVERS					
645086	ON-OFF	20W	IP20	500mA	
644758-5	ON-OFF	6W	IP20	500mA	
645626-1	ON-OFF	20W	IP67	500mA	

OP. Disponibile alimentatore in emergenza - Safety driver available

E...-LBL = LED blu-blue

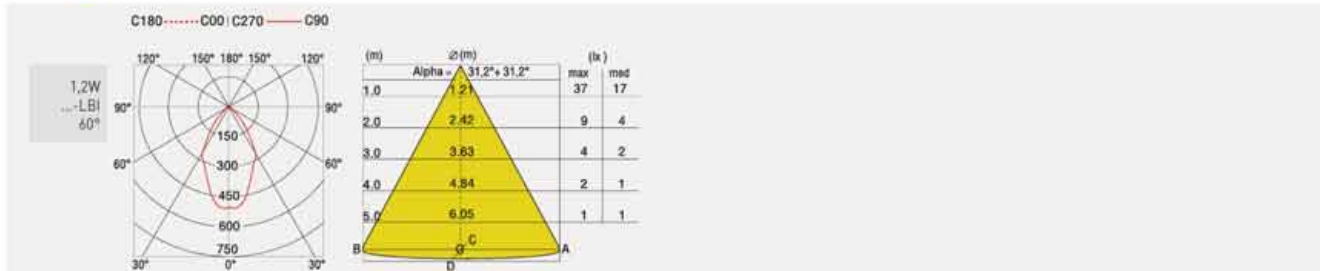

ALIMENTATORI-KIT RGB (se non in dotazione) da ordinare dalla sezione arancio - DRIVERS-RGB KITS (when not supplied) to be ordered from the section orange color

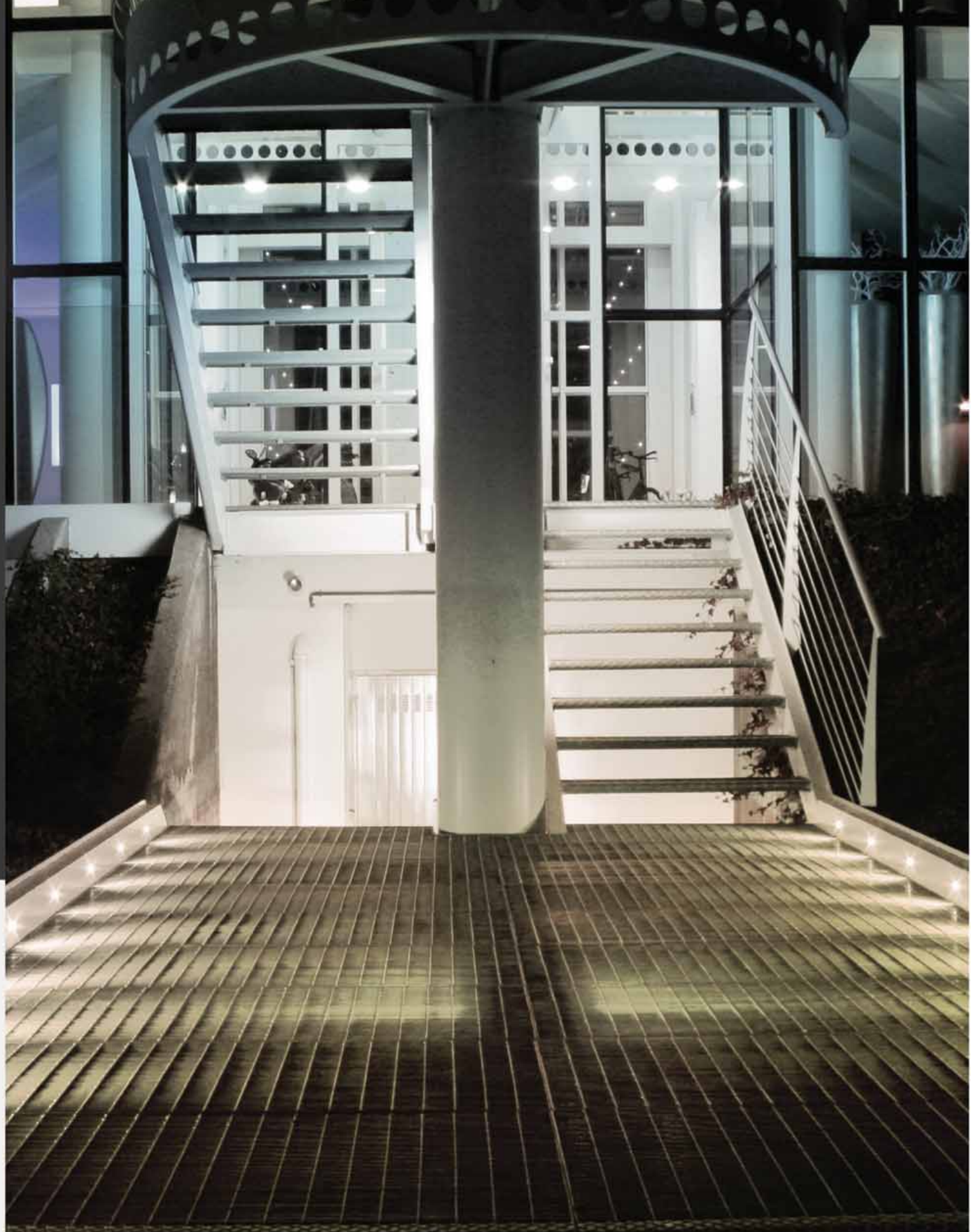



EYES WALL FLAT COB

- Incasso in ottone cromato con Led ad alta emissione.
- Anello di finitura in acciaio Inox (AISI 316).
- Parabola metallizzata (solo COB) e vetro di protezione.
- Apparecchio da incasso a parete.

- Recessed fitting made of chromed brass provided with high emission Led.
- Finishing stainless steel ring (AISI 316).
- Metalized reflector (only COB) and protection glass.
- Wall mounting recessed fixture.



28 mm

LED COB

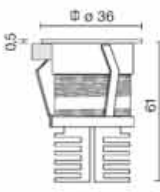

INCASSO PER PARETI SOLIDE - SUITABLE FOR CONCRETE WALLS

	E871-M-LBC-C	1x3,5W	285	350mA	3000	>90
	E871-M-LBN-C		300		4000	
	E871-MQ-LBC-C	1x3,5W	285	350mA	3000	>90
	E871-MQ-LBN-C		300		4000	

ALIMENTATORI CONSIGLIATI - RECOMMENDED DRIVERS

644758	ON-OFF	6W	IP20	350mA
644759-1	DN-OFF	15W	IP20	350mA
646258-67	DN-OFF	15W	IP67	350mA

OP. Disponibile alimentatore in emergenza - Safety driver available
Solo per sorgenti NON COB - Only for NON COB sources

ACC. **186-3** Cassettaforma per incasso a parete
Wall mounting pit

IP 68

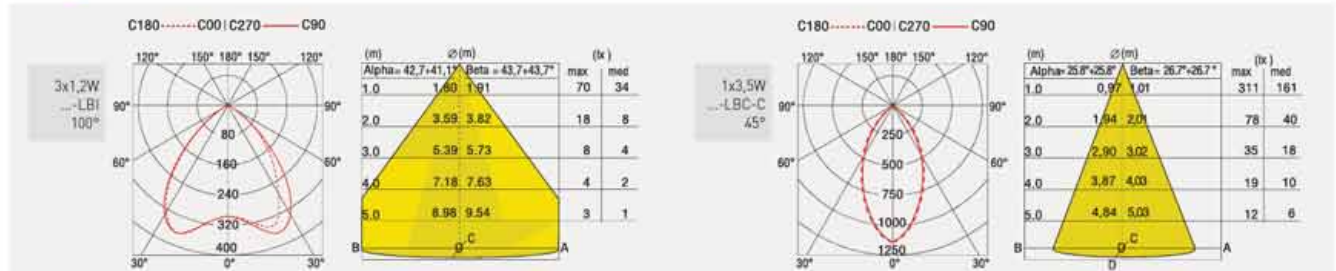

ALIMENTATORI-KIT RGB (se non in dotazione) da ordinare dalla sezione arancio - DRIVERS-RGB KITS (when not supplied) to be ordered from the section orange color





- Faretto da incasso calpestabile con corpo e ghiera in acciaio inox Aisi 316L.
- Guarnizioni gomma siliconica.
- Diffusore in policarbonato.
- Viti premiguarnizione in ottone nichelato.
- Cavo di alimentazione in neoprene 2x0,5 mm², lunghezza 500 mm.
- Led durata utile: 50.000 (h) L90 B20.
- Molla fissaggio in controsoffitto in dotazione art. 579961.
- Foro da predisporre per incasso Ø 31 mm.

- Walk-over recessed spotlight with body and trim in AISI 316L stainless steel.
- Silicon rubber gaskets.
- Polycarbonate diffuser.
- Pre-gasket screws in nickel-plated brass.
- Neoprene power cable 2x0,5 mm², length 500 mm.
- Led life: 50.000 (h) L90 B20.
- Fixing springs to the false-ceiling supplied art. 579961.
- Hole to be set up for Ø 31 mm recess.

RING



	W	lm	V	K	CR	T	
Inox E880-LBC	1,5W	145	500mA	3000	>80	-	-
E880-LBN		155		4000			
E880-LBL		-		470nm			

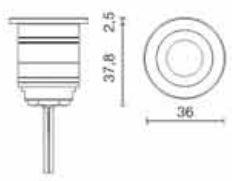

ALIMENTATORI CONSIGLIATI - RECOMMENDED DRIVERS

644758-5	8W	IP20	500mA	3 apparecchi - fittings
645496	10W	IP40	500mA	6 apparecchi - fittings
645086	20W	IP20	500mA	
645626-1	20W	IP65	500mA	

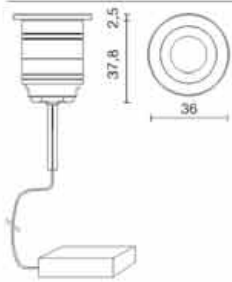

KIT 3 APPARECCHI + ALIMENTATORE - 3 FITTINGS + DRIVER							
Inox KT-E880-LBC-3	1,5W	145	220-240V	3000	>80	-	-
KT-E880-LBN-3		155	[500mA]	4000			
KT-E880-LBL-3		-		470nm			

KIT 6 APPARECCHI + ALIMENTATORE - 6 FITTINGS + DRIVER							
Inox KT-E880-LBC-6	1,5W	145	220-240V	3000	>80	-	-
KT-E880-LBN-6		155	[500mA]	4000			
KT-E880-LBL-6		-		470nm			

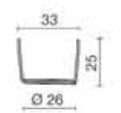

Molla di fissaggio
Fixing spring

ESEMPIO - EXAMPLE

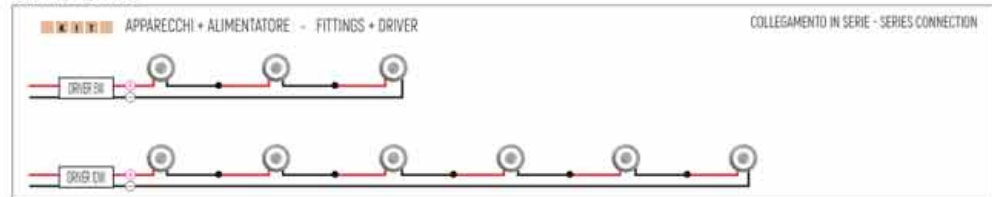

DP. Disponibile alimentatore in emergenza - Safety driver available

E...LRO = LED rosso-red

E...LVE = LED verde-green

E...LGI = LED ambramb-amber



ACC. 186-3 Cassaforma per incasso - Housing for recessed

5,00



IP 68
IK 09



outside

ALIMENTATORI-KIT RGB (se non in dotazione) da ordinare dalla sezione arancio - DRIVERS-RGB KITS (when not supplied) to be ordered from the section orange color



OLODUM MINI PARETE



- Corpo in pressofusione di alluminio, verniciato in polveri con pretrattamento speciale per esterni.
- Anello di finitura in acciaio Inox (AISI 316).
- Pressacavo in ottone nichelato PG11.
- Vetro temperato di spessore 10 mm.

- Body in die-cast aluminium with special powder treatment for outdoor use.
- Stainless steel (AISI 316) frame.
- PG11 nickel brass cable gland.
- Tempered glass 10 mm thick.

LED COB	Inox	E8184C-LBC15P E8184C-LBC24P E8184C-LBC40P	15 24 40	LED				SISTEMA-SYSTEM				
				W	lm	V	K	W	lm	lm/W		
		E8184C-LBN15P	15	12,3W	1120	350mA	4000		>80	14,3W	965	67
		E8184C-LBN24P	24	12,9W	1510				>80	14,3W	1274	86
		E8184C-LBN40P	40	12,9W	1430				>80	14,3W	1194	80

ALIMENTATORI CONSIGLIATI - RECOMMENDED DRIVERS

644759-1	ON-OFF	15W	IP20	350mA
J350-68-LED	ON-OFF	15W	IP68	350mA

OP. - TSC TORX Viti di sicurezza - Safety screws



ALIMENTATORI-KIT RGB (se non in dotazione) da ordinare dalla sezione arancio - DRIVERS-RGB KITS (when not supplied) to be ordered from the section orange color

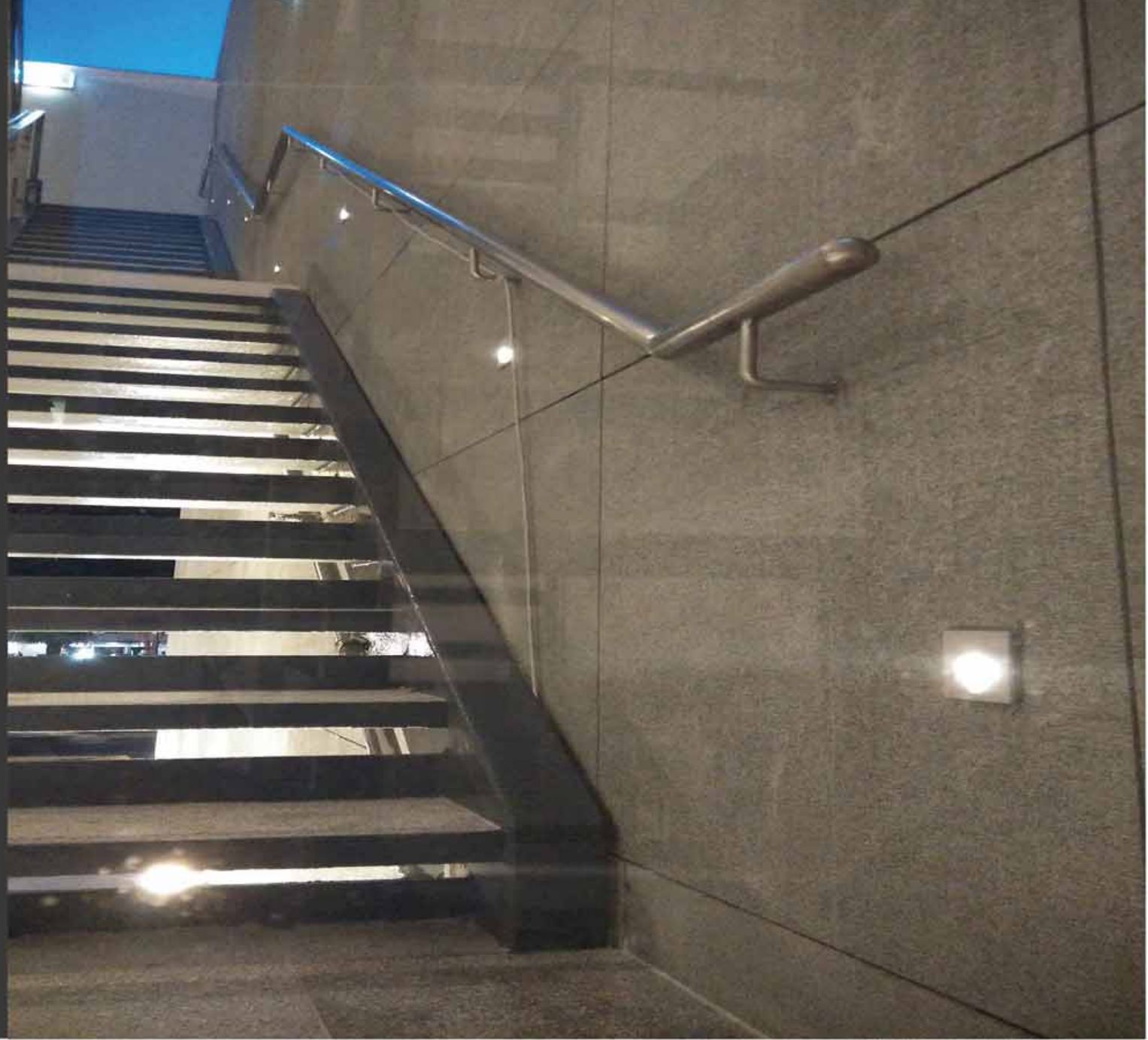

RIQUADRO MICRO LED



- Modulo da incasso a muro per scatola elettrica tipo 503E in dotazione.
- Corpo in alluminio pressofuso.
- Verniciatura in polveri poliesteri previo trattamento speciale per esterni.
- Viti in acciaio Inox.
- Corpo e dissipatore interno in ottone nichelato.
- Lente in metacrilato e guarnizioni in gomma silconica.
- Cavo di alimentazione 0,2 m. e connettori per cablaggi a tenuta stagna in dotazione.
- Led durata utile: 50.000 (h) L90 B20.

- Wall recessed fitting for electrical boxes type 503E (included).
- Die-cast aluminium body.
- Powder coated with pretreatment for outdoor use.
- Stainless steel screws.
- Body and internal heatsink made of nichel plated brass.
- Methacrylate lens and gasket gland made of silicone rubber.
- Supply cable 0,2 m. long and connectors for watertight wiring supplied.
- Led life: 50.000 (h) L90 B20.

	LED					SISTEMA-SYSTEM		
	W	lm	V	K	CRI	W	lm	W
E908-LBC	240	240	220-240V	3000	>80	5,5W	74	14
E908-LBN	270	270	[350mA]	4000			84	15
E908-LBI	300	300		5000			93	17

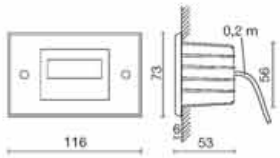

OP. A richiesta colorazioni piastra secondo tabella RAL - Plate colour on request according to RAL table

L'apparecchio si può montare anche nel solo box 503E
The fitting can be installed also using only the 503E box

Scatola da immergere tipo 503E in dotazione
Wall box type 503E included

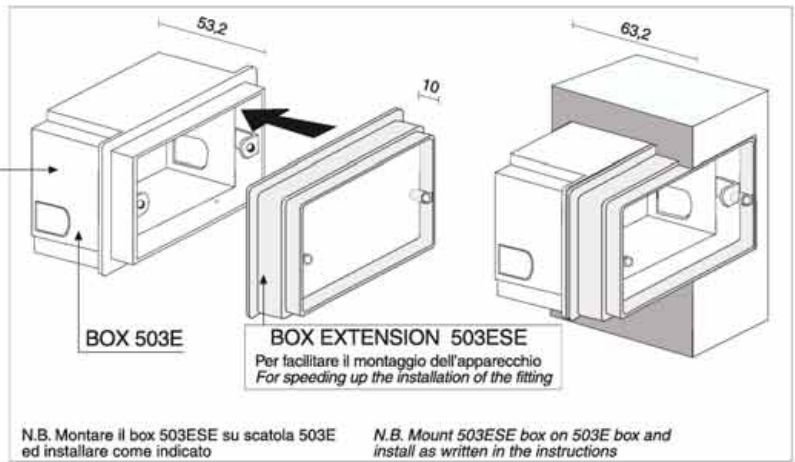
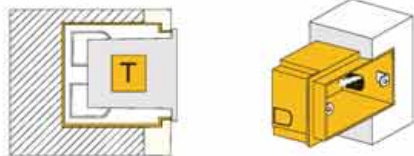

N.B. Montare il box 503ESE su scatola 503E ed installare come indicato
N.B. Mount 503ESE box on 503E box and install as written in the instructions



outside

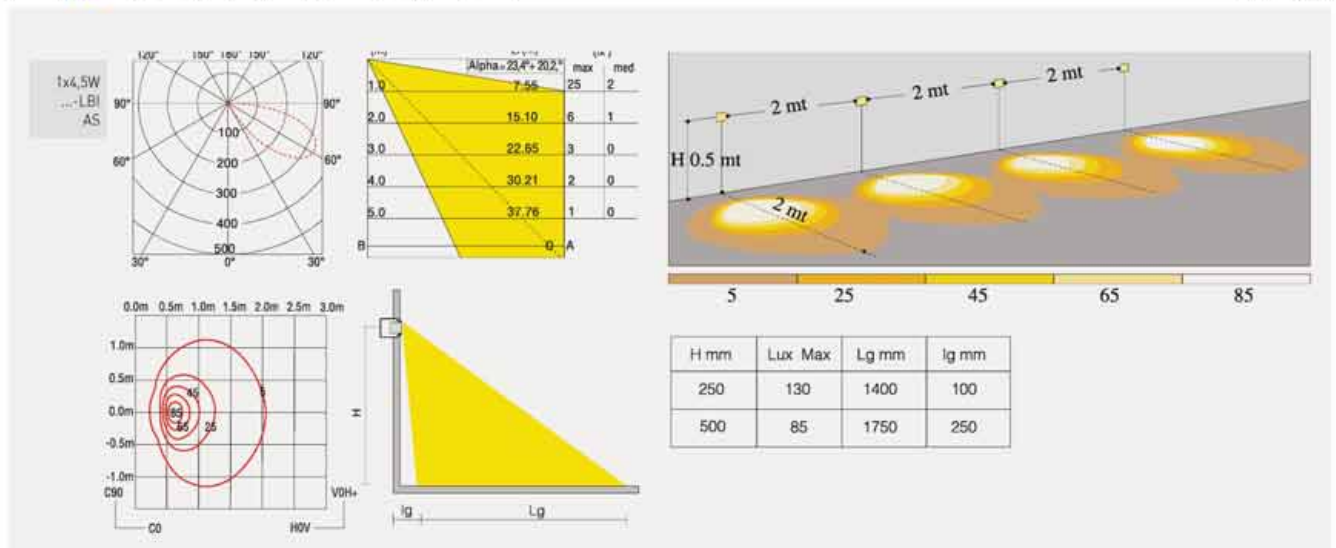

ALIMENTATORI-KIT RGB (se non in dotazione) da ordinare dalla sezione arancio - DRIVERS-RGB KITS (when not supplied) to be ordered from the section orange color

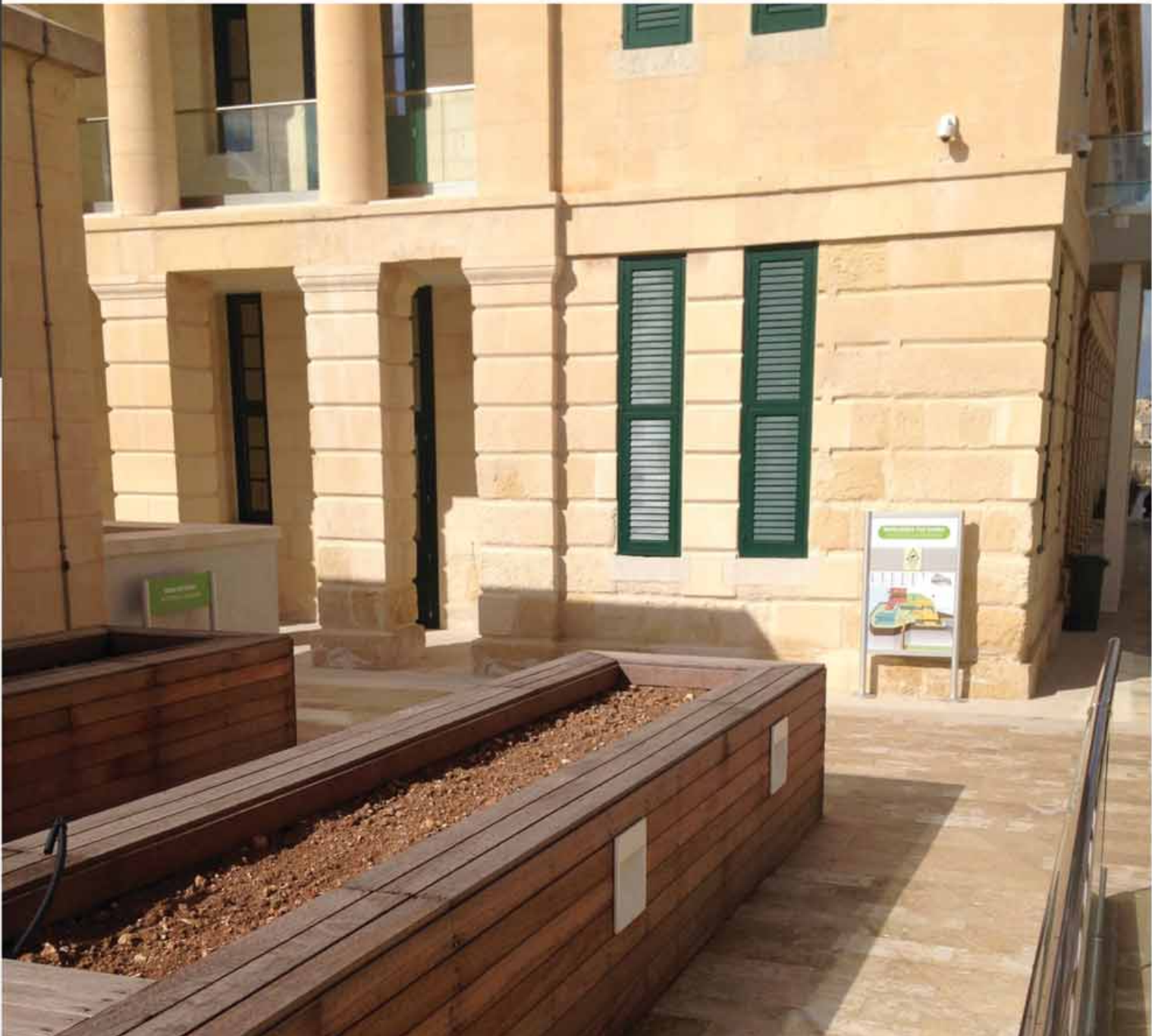

RIQUADRO

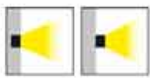

- Corpo in pressofuso di alluminio.
 - Verniciatura in polveri con pretrattamento speciale per esterni.
 - Vetro di protezione temperato.
 - Viti in acciaio Inox.
 - Guarnizioni in gomma silconica.
 - Cassaforma di alloggiamento inclusa.
 - Led durata utile: 50.000 (h) L90 B20.
 - Consistenza cromatica: 3 MCE.
- Die-cast aluminium body.
 - Powder coated with pretreatment for outdoor use.
 - Tempered protection glass.
 - Inox steel screws.
 - Gasket in silicone rubber.
 - Recessed housing included.
 - Led life: 50.000 (h) L90 B20.
 - Chromatic consistency: 3 MCE.

			LED					SYSTEM-SYSTEM		
			W	lm	V	K	CRI	W	lm	lm/W
 IP 65 Br E5345-LBC Ne E5346-LBC Gr E5347-LBC 2,50 Kg	Br	E5345-LBC	6x1,2W	600	220-240V (350mA)	3000	>80	8,2W	208	25
	Ne	E5346-LBC								
	Gr	E5347-LBC								
 IP 67 IK 04 Br E5345-LBN Ne E5346-LBN Gr E5347-LBN 3,50 Kg	Br	E5345-LBN	6x1,2W	660	220-240V (350mA)	4000	>80	8,2W	230	28
	Ne	E5346-LBN								
	Gr	E5347-LBN								
 IP 67 IK 04 Br E5313-LBC Ne E5314-LBC Gr E5315-LBC 3,50 Kg	Br	E5313-LBC	20,5W	2300	220-240V (350mA)	3000	>80	23,5W	922	39
	Ne	E5314-LBC								
	Gr	E5315-LBC								
 IP 67 IK 04 Br E5313-LBN Ne E5314-LBN Gr E5315-LBN 3,50 Kg	Br	E5313-LBN	20,5W	2500	220-240V (350mA)	4000	>80	23,5W	1000	48
	Ne	E5314-LBN								
	Gr	E5315-LBN								

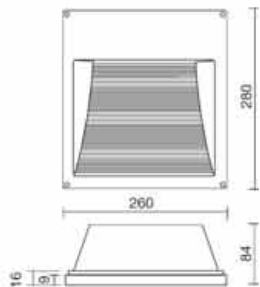

Cassaforma in plastica inclusa
Plastic recessed housing included

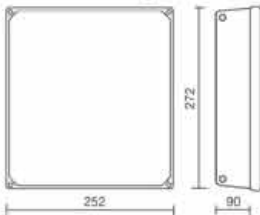

OP. A richiesta - On request: vetro sabbato - frosted glass
disponibile - available



ACC. Box per montaggio a parete - Box for wall mounting
Br 884-BR
Ne 884-NE
Gr 884-GR



outside

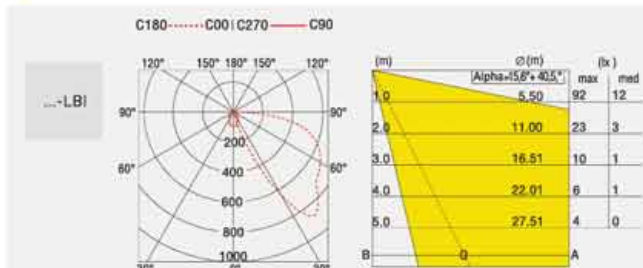

ALIMENTATORI-KIT RGB (se non in dotazione) da ordinare dalla sezione arancio - DRIVERS-RGB KITS (when not supplied) to be ordered from the section orange color



NEW GREEN XS

- Corpo e telaio in pressofusione di alluminio verniciato con polveri poliestere con pretrattamento speciale per esterni.
- Modulo da incasso a muro per scatole elettriche tipo 503E + 503ESE entrambe in dotazione.
- Fissaggio telaio tramite molle [a richiesta viti antivandalò].
- Guarnizioni e pressacavo in gomma siliconica.
- Vetro di protezione extrachiario per versione asimmetrica.
- Vetro di protezione opale bianco per versione simmetrica.
- Cavo di alimentazione 0,2 m. e connettori per cablaggi a tenuta stagna in dotazione.
- Alimentatore integrato.

- Aluminum die cast body and frame painted with polyester powder with pretreatment for outdoor use.
- Recessed wall module for electrical boxes type 503E + 503ESE [both typer supplied].
- Springs fixing frame [on request vandal-proof screws].
- Silicon rubber seals and cable gland.
- Transparent extra light protection glass for asymmetrical frame.
- White opal protection glass for symmetrical frame.
- Power cable 0,2 m. long and connectors for harenesses tight wiring supplied.
- Integrated driver.

	LED	SISTEMA-SYSTEM						
		W	lm	V	K	(CRI)	W	lm
 LUCE ASIMMETRICA - ASYMMETRIC LIGHT Br E5887-LBC Ne E5888-LBC Ga E5889-LBC 	4,5W	240	220-240V [350mA]	3000	>80	5,5W	104	19
	4,5W	270	220-240V [350mA]	4000	>80	5,5W	117	21
	Br E5887-LBN Ne E5888-LBN Ga E5889-LBN							
 LUCE SIMMETRICA - SYMMETRIC LIGHT Br E5890-LBC Ne E5891-LBC Ga E5892-LBC 	4,5W	300	220-240V [350mA]	3000	>80	5,5W	150	27
	4,5W	300	220-240V [350mA]	4000	>80	5,5W	130	24
	Br E5890-LBN Ne E5891-LBN Ga E5892-LBN							

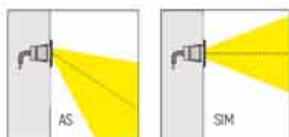

OP. A richiesta: versione con viti antivandalò Es. codice ...V On request: vandal-proof screws version: Ex. code ...V



L'apparecchio si può montare anche nel solo box 503E
The fitting can be installed also using only the 503E box

Scatola da immurare tipo 503E in dotazione
Wall box type 503E included

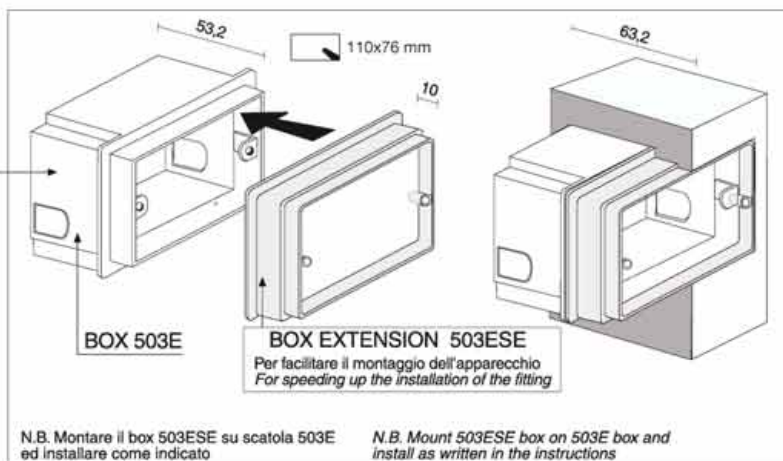
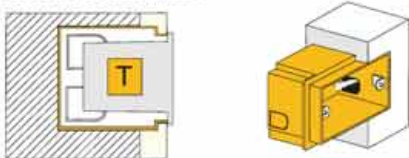

outside

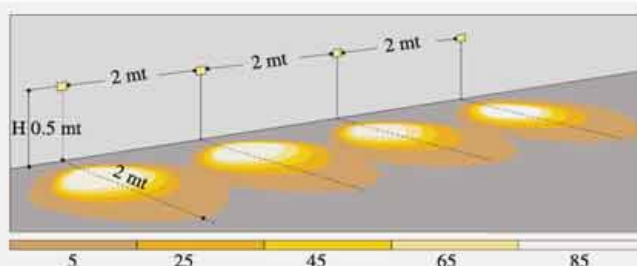
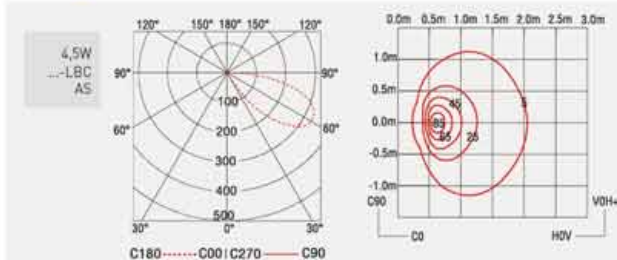

ALIMENTATORI-KIT RGB (se non in dotazione) da ordinare dalla sezione arancio - DRIVERS-RGB KITS (when not supplied) to be ordered from the section orange color

NEW GREEN M



- Corpo e telaio in pressofusione di alluminio verniciato con polveri poliestere con pretrattamento speciale per esterni.
- Fissaggio telaio tramite molle (a richiesta viti antivandalo).
- Vetro di protezione extrachiario per telaio asimmetrico.
- Vetro di protezione bianco opalino per telaio simmetrico.
- Cavo di alimentazione 0,2 m. e connettori per cablaggi a tenuta stagna in dotazione.



- Aluminum die-cast body and frame painted with polyester powder with pretreatment for outdoor use.
- Screwless frame (on request vandal-proof screws).
- Transparent extra light protection glass for asymmetrical frame.
- White opal protection glass for symmetrical frame.
- Power cable 0,2 m. long and connectors for harnesses tight wiring supplied.

	LED	SISTEMA-SYSTEM					
		W	lm	lm/W			
LUCE ASIMMETRICA - ASYMMETRIC LIGHT	W	V	K	CRI	W	lm	lm/W
Br E5881-LBC	5W	220-240V (350mA)	3000	>80	6W	196	33
Ne E5882-LBC	5W	220-240V (350mA)	4000	>80	6W	204	34
Ga E5883-LBC	5W	220-240V (350mA)	3000	>80	6W	210	35
LUCE SIMMETRICA - SYMMETRIC LIGHT	W	V	K	CRI	W	lm	lm/W
Br E5884-LBN	5W	220-240V (350mA)	4000	>80	6W	220	37
Ne E5885-LBN	5W	220-240V (350mA)	4000	>80	6W	220	37
Ga E5886-LBN	5W	220-240V (350mA)	4000	>80	6W	220	37

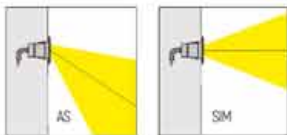
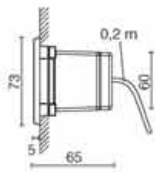
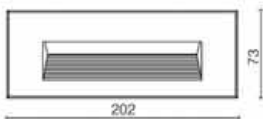

OP: A richiesta: versione con viti antivandalo Es. codice ...V
On request: vandal-proof screws version: Ex. code ...V



Kit piastra compensazione telaio con fori per cassaforma Green codice 319200
Kit plate compensation frame with holes for Green housing code 319200
Br 119-06
Ne 119-07
Gr 119-19

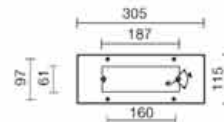

ACC. 320001 Scatola da immurare
Container for recessed wall light
215x85 mm

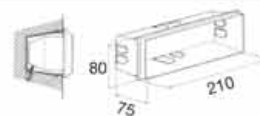

outside

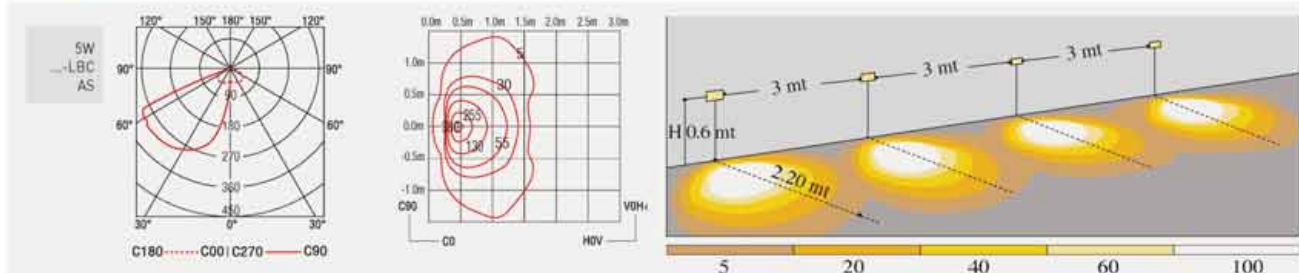

ALIMENTATORI-KIT RGB (se non in dotazione) da ordinare dalla sezione arancio - DRIVERS-RGB KITS (when not supplied) to be ordered from the section orange color



NEW GREEN XL



- Corpo e telaio in pressofusione di alluminio verniciato, con polveri poliestere con pretrattamento speciale per esterni.
- Fissaggio telaio tramite molle (a richiesta viti antivandalo).
- Vetro di protezione extrachiario per telaio asimmetrico.
- Vetro di protezione bianco opalino per telaio simmetrico.
- Cavo di alimentazione 0,2 m. e connettori per cablaggi a tenuta stagna in dotazione.

- Aluminum die-cast body and frame painted with polyester powder with pretreatment for outdoor use.
- Screwless frame (on request vandal-proof screws).
- Transparent extra light protection glass for asymmetrical frame.
- White opal protection glass for symmetrical frame.
- Power cable 0.2 m. long and connectors for harenesses tight wiring supplied.



	LED	SISTEMA-SYSTEM						
		W	lm	lm/W				
 LUCE ASIMMETRICA - ASYMMETRIC LIGHT Br E5875-LBC Ne E5876-LBC Ga E5877-LBC	8,5W	910	220-240V (350mA)	3000	>80	9,5W	388	41
	8,5W	950	220-240V (350mA)	4000	>80	9,5W	405	43
	8,5W	910	220-240V (350mA)	3000	>80	9,5W	444	47
 LUCE SIMMETRICA - SYMMETRIC LIGHT Br E5878-LBC Ne E5879-LBC Ga E5880-LBC	8,5W	950	220-240V (350mA)	4000	>80	9,5W	463	49
	8,5W	950	220-240V (350mA)	4000	>80	9,5W	463	49
	8,5W	950	220-240V (350mA)	4000	>80	9,5W	463	49

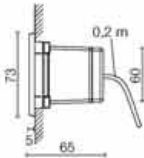

OP: A richiesta: versione con viti antivandalo Es. codice ...V
 On request: vandal-proof screws version: Ex. code ...V

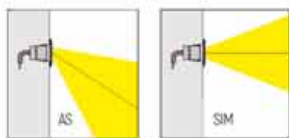
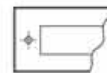

ACC. 320000 Scatola da immurare
 Container for recessed wall light

355x85 mm

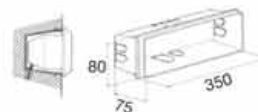

IP 65 IK 07



outside

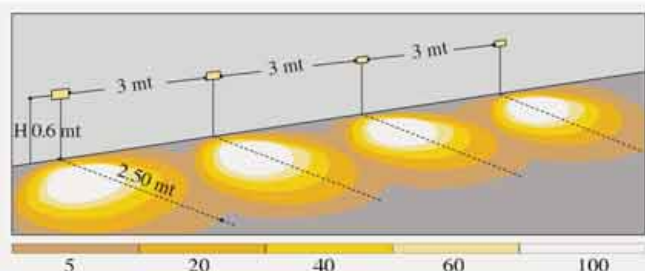
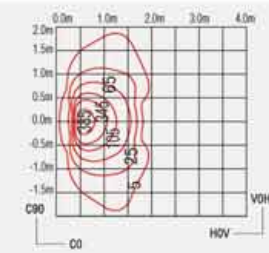
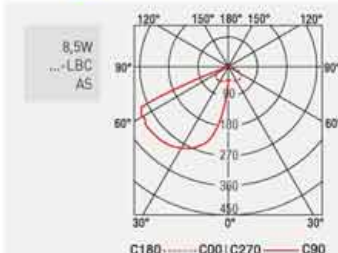

ALIMENTATORI-KIT RGB (se non in dotazione) da ordinare dalla sezione arancio - DRIVERS-RGB KITS (when not supplied) to be ordered from the section orange color





JOGGER



- Modulo da incasso a muro.
- Corpo in materiale termoplastico.
- Viti in acciaio Inox.
- Riflettore in alluminio ossidato.
- Wall recessed fitting.
- Body made of thermoplastic material.
- Inox steel screws.
- Oxidized aluminium reflector.

	W	lm	V	K	CRI
E912-LBC		130		5000	
E912-LBN	ZW	150	220-240V	4000	+80
E912-LBL		-		470nm	

N.B. Senza scatola da immerare tipo 503E - Without wall box type 503E

DP. A richiesta: colorazioni corpo **nero Ne - grigio Gr - RAL**
 On request body colour: **black Ne - grey Gr - RAL**

IP 65 IP 65 apparecchio/fitting driver

1.4W
LBI
AS

(m)	∅ (m)	(lx)	max	med
1.0	8.05	17	1	
2.0	16.09	4	0	
3.0	24.14	2	0	
4.0	32.19	1	0	
5.0	40.23	1	0	
B	0	A		

H 0.3 mt
1.5 mt
1 mt

H mm	Lux Max	Lg mm	lg mm
300	180	1000	100

ALIMENTATORI-KIT RGB (se non in dotazione) da ordinare dalla sezione arancio - DRIVERS-RGB KITS (when not supplied) to be ordered from the section orange color



APPLY MINI

- Apparecchio in pressofusione di alluminio.
- Vernice in polveri con pretrattamento speciale per esterni.
- Vetro di protezione temperato e sabbato.
- Gruppo di alimentazione inserito nell'apparecchio.

- Fitting of die-cast aluminium.
- Powder coated after special treatment for outdoor use.
- Frosted and tempered protection glass.
- Built-in control gear.



		LED					SISTEMA-SYSTEM			
		W	lm	V	K	CRI	W	lm	W	
	Ne	E8065-LBC								
	Ga	E8066-LBC	6x1,2W	650	220-240V (350mA)	3000	>80	8,2W	576	70
	Bw	E8067-LBC								
	Ne	E8065-LBN								
	Ga	E8066-LBN	6x1,2W	650	220-240V (350mA)	4000	>80	8,2W	578	70
	Bw	E8067-LBN								

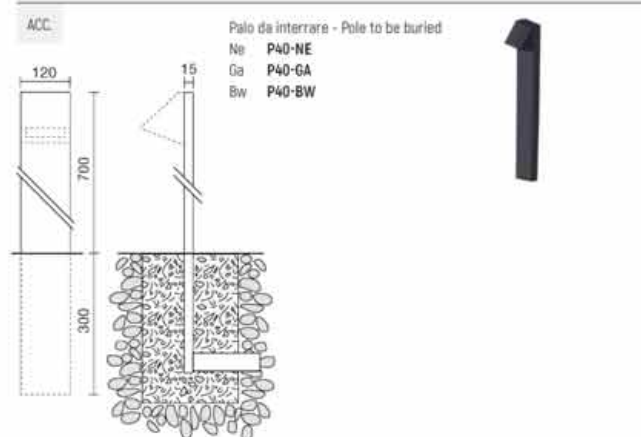
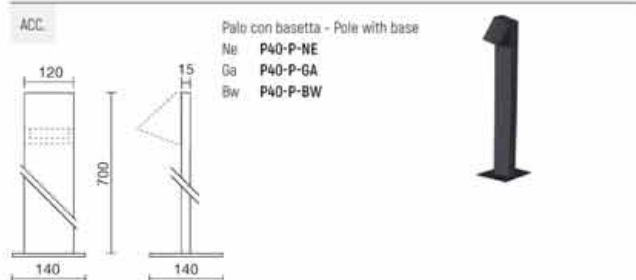
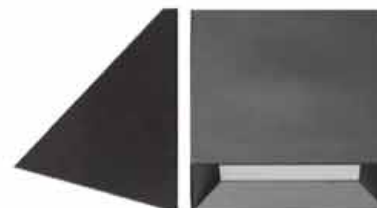

outside

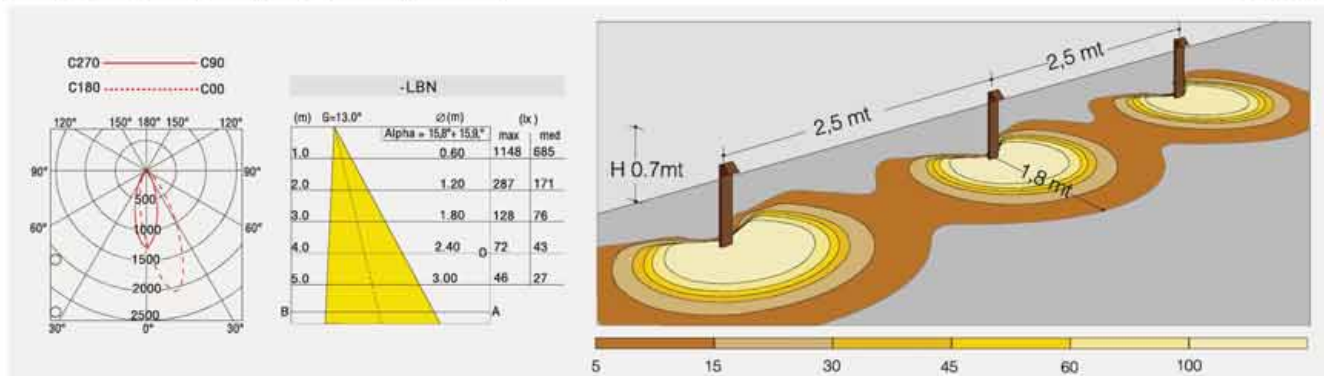

ALIMENTATORI-KIT RGB (se non in dotazione) da ordinare dalla sezione arancio - DRIVERS-RGB KITS (when not supplied) to be ordered from the section orange color

APPLY 1-2



- Apparecchio in pressofusione di alluminio.
 - Vernice in polveri con pretrattamento speciale per esterni.
 - Vetro di protezione temperato e sabbato.
 - Gruppo di alimentazione inserito nell'apparecchio.
- Fitting of die-cast aluminium.
 - Powder coated after special treatment for outdoor use.
 - Frosted and tempered protection glass.
 - Built-in control gear.

APPLY 1		LED					SYSTEM-SYSTEM			
		W	lm	V	K	CRI	W	lm	lm/W	
<p>275</p>	<p>MONO EMISSIONE MONO EMISSION</p> <p>1Kg 1,50</p> <p>Ne</p>	E8050-LBC	860	220-240V 24Vcc	3000	>80	9W	518	57	
		E8050-LBN	2x4,8W		900			4000	594	66
		E8050-LBI	860		6000			620	69	



APPLY 2		LED					SYSTEM-SYSTEM			
		W	lm	V	K	CRI	W	lm	lm/W	
<p>140</p> <p>280</p>	<p>MONO EMISSIONE MONO EMISSION</p> <p>1Kg 1,80</p> <p>Ne</p>	E8040-LBC	860	220-240V 24Vcc	3000	>80	9W	569	63	
		E8040-LBN	2x4,8W		900			4000	561	62
		E8040-LBI	960		6000			624	69	



APPLY 2		LED					SYSTEM-SYSTEM			
		W	lm	V	K	CRI	W	lm	lm/W	
<p>140</p> <p>280</p>	<p>DOPPIA EMISSIONE DOUBLE EMISSION</p> <p>1Kg 1,80</p> <p>Ne</p>	E8046-LBC	(A) 430 (B) 860	220-240V 24Vcc	3000	>80	14W	894	64	
		E8046-LBN	3x4,8W		(A) 450 (B) 900			4000	935	67
		E8046-LBI	(A) 480 (B) 960		6000			997	71	

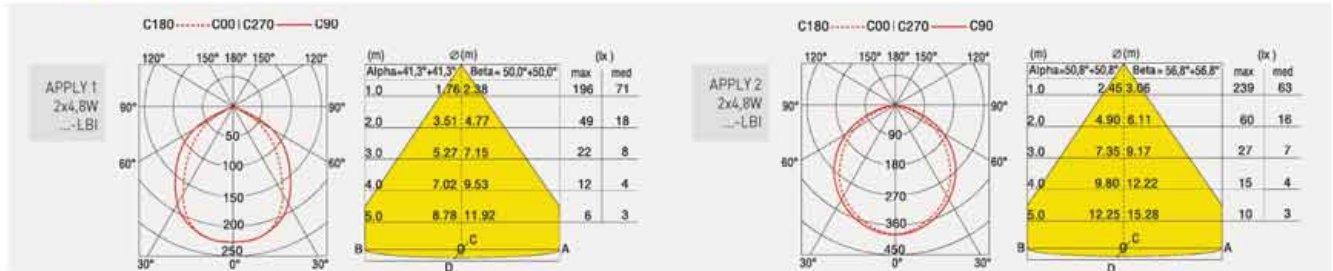

ALIMENTATORI-KIT RGB (se non in dotazione) da ordinare dalla sezione arancio - DRIVERS-RGB KITS (when not supplied) to be ordered from the section orange color



PARETE - PLAFONE - SOSPENSIONE
WALL - CEILING - SUSPENSION

**ELLE PARETE
XS**
505

**ELLE PARETE
XL**
505

MINI TONDO
507

MINI QUADRO
508

**MONOLIGHT
105**
510

**MONOLIGHT
140**
511

**MONOLIGHT
175**
513

**DOUBLELIGHT
105**
515

**DOUBLELIGHT
140**
516

**DOUBLELIGHT
175**
517

QUADRO
519

**MICRO
VARIANT**
522

**MINI
VARIANT**
523

QUADERS
525

**NEW QUARTO
DI SFERA**
527

MOON
529

CERKIO XS-XL
530

FENIX
533

SOLID
535

**MINI MISTRAL
LED**
537

MISTRAL LED
539

**QUADRO
CEILING**
541

**CEILING
105**
543

**CEILING
140**
544

**CEILING
175**
545

**CEILING S
105**
547

CEILING S 140
548

CEILING S 175
549

SOLARIS
552

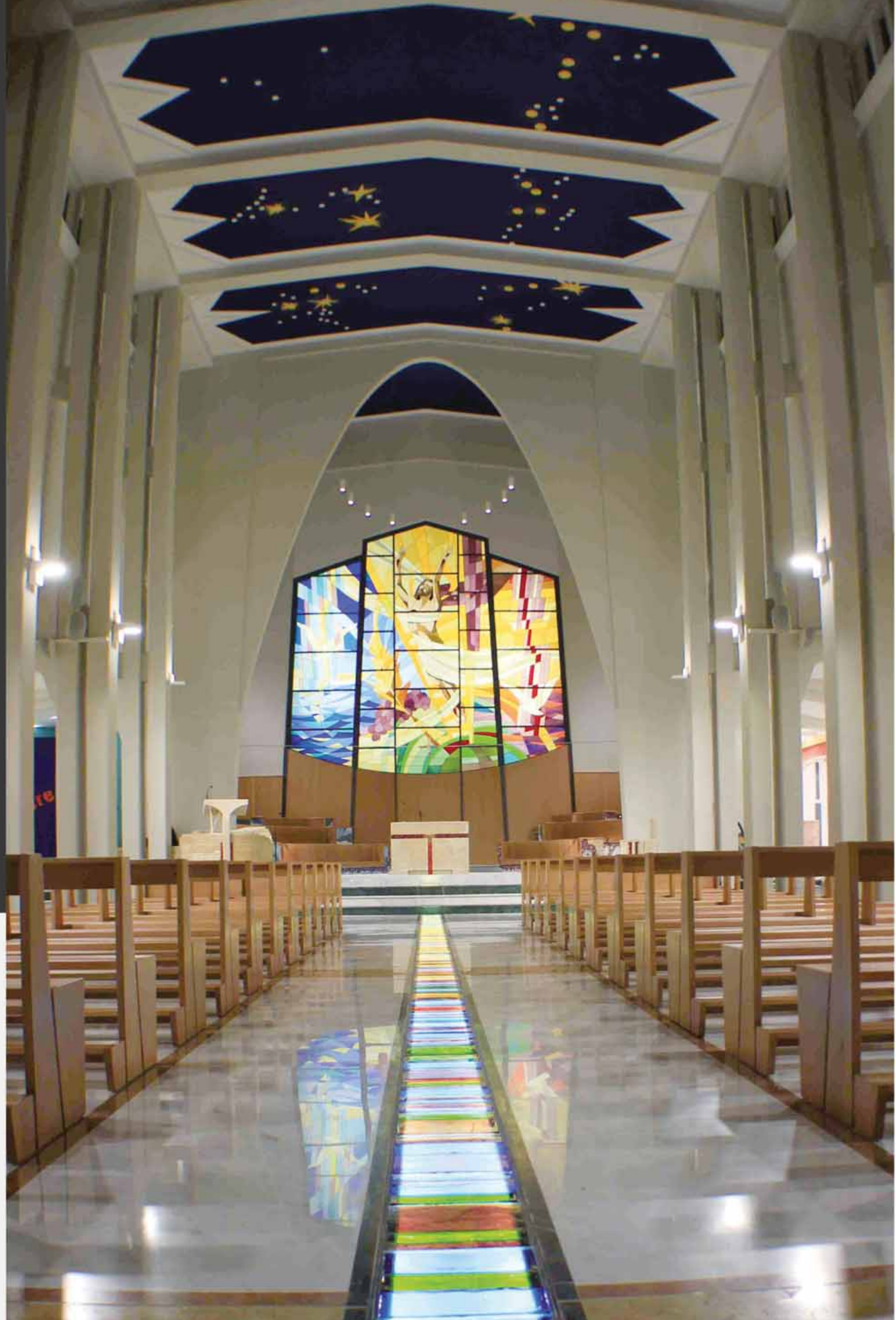
ELLE PARETE XS-XL



- Corpo e struttura in pressofusione di alluminio.
- Verniciatura in polveri epossidiche con trattamento speciale per e
- Vetro di protezione temperato.
- Guarnizione e pressocavo PG11 in gomma silconica.
- Body and frame in die-cast aluminium.
- Epoxy powder coated with special treatment for outdoor use.
- Tempered protection glass.
- Silicone rubber and PG11 cable clamp.



	LED	SYSTEM-SYSTEM					
		W	lm	W			
 	ELLE PARETE XS LUCE SIMMETRICA - SYMMETRIC LIGHT						
	Gr E4083-LBC	12W	2020	220-240V [350mA]	14W	1870	133
	Ne E4084-LBC						
	Bw E4085-LBC						
	Gr E4083-LBN	12W	2100	220-240V [350mA]	14W	1943	139
	Ne E4084-LBN						
Bw E4085-LBN							
 	ELLE PARETE XL LUCE ASIMMETRICA STRADALE - ASYMMETRIC LIGHT STREET						
	Gr E4083AS-LBC	12W	2020	220-240V [350mA]	14W	1870	139
	Ne E4084AS-LBC						
	Bw E4085AS-LBC						
	Gr E4083AS-LBN	12W	2100	220-240V [350mA]	14W	1943	133
	Ne E4084AS-LBN						
Bw E4085AS-LBN							
	ELLE PARETE XL LUCE ASIMMETRICA STRADALE - ASYMMETRIC LIGHT STREET						
	Gr E4111-LBC	60W	8450	220-240V [850mA]	64W	7450	116
	Ne E4112-LBC						
	Bw E4113-LBC						
	Gr E4111-LBN	60W	8780	220-240V [850mA]	64W	7741	121
	Ne E4112-LBN						
Bw E4113-LBN							



ALIMENTATORI-KIT RGB (se non in dotazione) da ordinare dalla sezione arancio - DRIVERS-RGB KITS (when not supplied) to be ordered from the section orange color







MINI MONO TONDO

- Corpo in alluminio pressofuso.
- Verniciatura in polveri con pretrattamento speciale per esterni.
- Vetro di protezione temperato.
- Anello di finitura in acciaio inox AISI 316.
- Viteria in acciaio inox.
- Gruppo di alimentazione inserito nell'apparecchio.
- Ottiche in alluminio purissimo.
- Guarnizioni e pressacavo di tenuta in gomma siliconica.

- Die-cast aluminium body.
- Powder coated with pretreatment for outdoor use.
- Tempered protection glass.
- AISI 316 steel finishing trim.
- Inox steel screws.
- Internal driver.
- Very pure aluminium optics.
- Silicon rubber gaskets and cable gland.



	LED					SISTEMA-SYSTEM		
	W	lm	V	K	CRI	W	lm	lm/W
 MONO EMISSIONE - MONO EMISSION Br E4900-LBC-M Ne E4901-LBC-M Gr E4902-LBC-M 	1x11,5W	1840	220-240V [350mA]	3000	>90	13,5W	1178	87
Br E4900-LBN-M Ne E4901-LBN-M Gr E4902-LBN-M	1x11,5W	1950	220-240V [350mA]	4000	>90	13,5W	1261	93

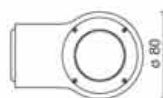
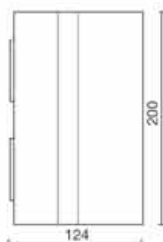

outside

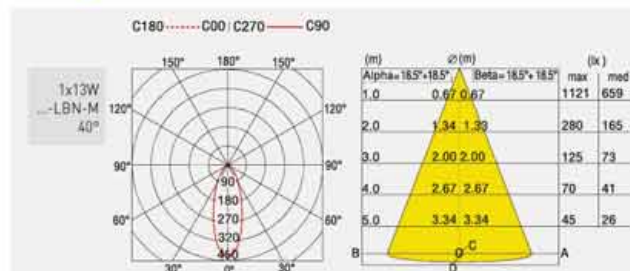



MINI DOUBLE TONDO



- Corpo in alluminio pressofuso.
- Verniciatura in polveri con pretrattamento speciale per esterni.
- Vetro di protezione temperato.
- Anello di finitura in acciaio inox AISI 316.
- Viteria in acciaio inox.
- Gruppo di alimentazione inserito nell'apparecchio.
- Ottiche in alluminio purissimo.
- Guarnizioni e pressacavo di tenuta in gomma siliconica.
- Die-cast aluminium body.
- Powder coated with pretreatment for outdoor use.
- Tempered protection glass.
- AISI 316 steel finishing trim.
- Inox steel screws.
- Internal driver.
- Very pure aluminium optics.
- Silicon rubber gaskets and cable gland.

	LED	SISTEMA-SYSTEM					
		W	lm	lm/W			
	1 FASCIO STRETTO 5° - 1 NARROW BEAM 5°						
	Br E4900-LBC-1L	11,5-12W	1840/80	220-240V (350mA)			
	Ne E4901-LBC-1L				3000	>90	
	Gr E4902-LBC-1L						14,7W
	Br E4900-LBN-1L	11,5-12W	1950/85	220-240V (350mA)			
	Ne E4901-LBN-1L				4000	>90	
Gr E4902-LBN-1L	14,7W						1450
2 FASCI STRETTI 5° - 2 NARROW BEAMS 5°							
Br E4905-LBC-2L		2x2,5W	2x125	220-240V (700mA)			
Ne E4906-LBC-2L	3000				>90		
Gr E4907-LBC-2L						6W	194
Br E4905-LBN-2L		2x2,5W	2x135	220-240V (700mA)			
Ne E4906-LBN-2L	4000				>90		
Gr E4907-LBN-2L						6W	210

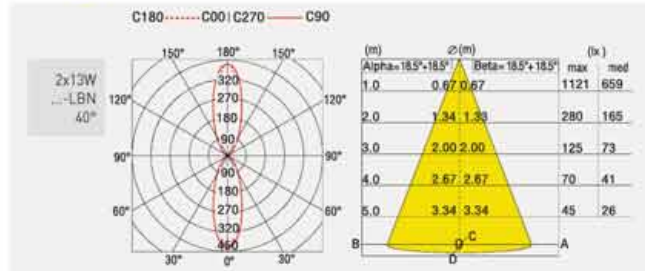

ALIMENTATORI-KIT RGB (se non in dotazione) da ordinare dalla sezione arancio - DRIVERS-RGB KITS (when not supplied) to be ordered from the section orange color

PARETE - PLAFONE - SOSPENSIONE • WALL - CEILING - SUSPENSION





MINI MONO QUADRO

- Corpo in alluminio pressofuso.
- Verniciatura in polveri con pretrattamento speciale per esterni.
- Vetro di protezione temperato.
- Anello di finitura in acciaio inox AISI 316.
- Viteria in acciaio inox.
- Gruppo di alimentazione inserito nell'apparecchio.
- Ottiche in alluminio purissimo.
- Guarnizioni e pressacavo di tenuta in gomma siliconica.

- Die-cast aluminium body.
- Powder coated with pretreatment for outdoor use.
- Tempered protection glass.
- AISI 316 steel finishing trim.
- Inox steel screws.
- Internal driver.
- Very pure aluminium optics.
- Silicon rubber gaskets and cable gland.



	LED					SISTEMI-SYSTEM		
	W	lm	V	K	CRI	W	lm	IP
 MONO EMISSIONE - MONO EMISSION Br E4910-LBC-M Ne E4911-LBC-M Gr E4912-LBC-M 	1x11,5W	1840	220-240V (350mA)	5000	>90	13,5W	1178	67
Br E4910-LBN-M Ne E4911-LBN-M Gr E4912-LBN-M 	1x11,5W	1950	220-240V (350mA)	4000	>90	13,5W	1264	95



outside

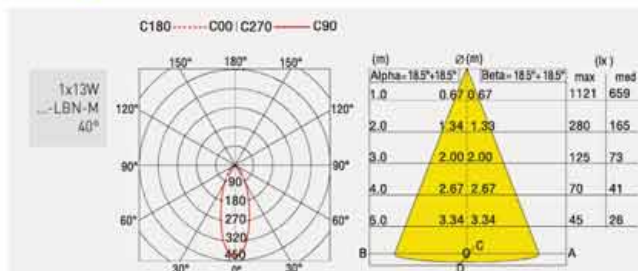

ALIMENTATORI-KIT RGB (se non in dotazione) da ordinare dalla sezione arancio - DRIVERS-RGB KITS (when not supplied) to be ordered from the section orange color

MINI DOUBLE QUADRO



- Corpo in alluminio pressofuso.
- Verniciatura in polveri con pretrattamento speciale per esterni.
- Vetro di protezione temperato.
- Anello di finitura in acciaio inox AISI 316.
- Viteria in acciaio inox.
- Gruppo di alimentazione inserito nell'apparecchio.
- Ottiche in alluminio purissimo.
- Guarnizioni e pressacavo di tenuta in gomma siliconica.
- Die-cast aluminium body.
- Powder coated with pretreatment for outdoor use.
- Tempered protection glass.
- AISI 316 steel finishing trim.
- Inox steel screws.
- Internal driver.
- Very pure aluminium optics.
- Silicon rubber gaskets and cable gland.

	LED	SISTEMA-SYSTEM		
		W	lm	lm/W
	1 FASCIO STRETTO 5° - 1 NARROW BEAM 5°			
	Br E4910-LBC-1L			
	Ne E4911-LBC-1L	11,5+1,2W	1940/89	220-240V (350mA)
	Gr E4912-LBC-1L			3000 >90
	Br E4910-LBN-1L			
	Ne E4911-LBN-1L	11,5+1,2W	1990/85	220-240V (350mA)
Gr E4912-LBN-1L			4000 >90	
	2 FASCI STRETTI 5° - 2 NARROW BEAMS 5°			
	Br E4915-LBC-2L			
	Ne E4916-LBC-2L	2x2,5W	2x125	220-240V (700mA)
	Gr E4917-LBC-2L			3000 >90
	Br E4915-LBN-2L			
	Ne E4916-LBN-2L	2x2,5W	2x135	220-240V (700mA)
Gr E4917-LBN-2L			4000 >90	

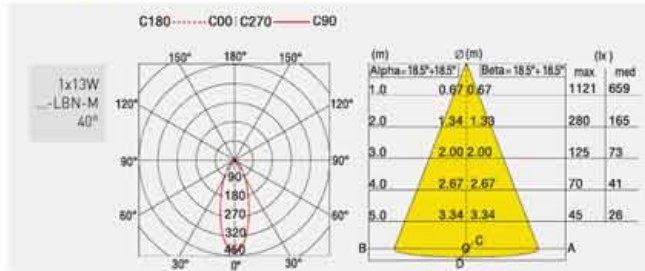

ALIMENTATORI-KIT RGB (se non in dotazione) da ordinare dalla sezione arancio - DRIVERS-RGB KITS (when not supplied) to be ordered from the section orange color



MONOLIGHT 105

- Corpo e staffa di ancoraggio in alluminio pressofuso.
 - Verniciatura in polveri con pretrattamento speciale per esterni.
 - Vetro di protezione temperato.
 - Viteria in acciaio inox.
 - Gruppo di alimentazione inserito nell'apparecchio.
 - Guarnizioni e pressacavo di tenuta in gomma siliconica.
- Body and wall bracket in die-cast aluminium.
 - Powder coated with pretreatment for outdoor use.
 - Tempered protection glass.
 - Inox steel screws.
 - Internal driver.
 - Silicon rubber gaskets and cable gland.



LED COB	Br	Ne	Gr	E	LED						SISTEM-SYSTEM		
					W	lm	V	K	°	(CRI)	W	lm	W
	Br			E5550C-LBC-15	12,5W	1040	350mA	3000	>90	14,3W	894	63	
	Ne			E5551C-LBC-15									
	Gr			E5552C-LBC-15									
	Br			E5550C-LBN-15	12,3W	1120	350mA	4000	>90	14,3W	962	66	
	Ne			E5551C-LBN-15									
	Gr			E5552C-LBN-15									
	Br			E5550C-LBC-24	12,9W	1430	350mA	3000	>90	14,9W	1208	81	
	Ne			E5551C-LBC-24									
	Gr			E5552C-LBC-24									
	Br			E5550C-LBN-24	12,9W	1450	350mA	4000	>90	14,9W	1223	82	
	Ne			E5551C-LBN-24									
	Gr			E5552C-LBN-24									
	Br			E5550C-LBC-40	12,9W	1310	350mA	3000	>90	14,9W	1135	76	
	Ne			E5551C-LBC-40									
	Gr			E5552C-LBC-40									
	Br			E5550C-LBN-40	12,9W	1430	350mA	4000	>90	14,9W	1193	80	
	Ne			E5551C-LBN-40									
	Gr			E5552C-LBN-40									

OP E...-LBL = LED blu-blue
 E...-600178 A richiesta - On request: versione con vetro di sicurezza e filo anello - flush glass version

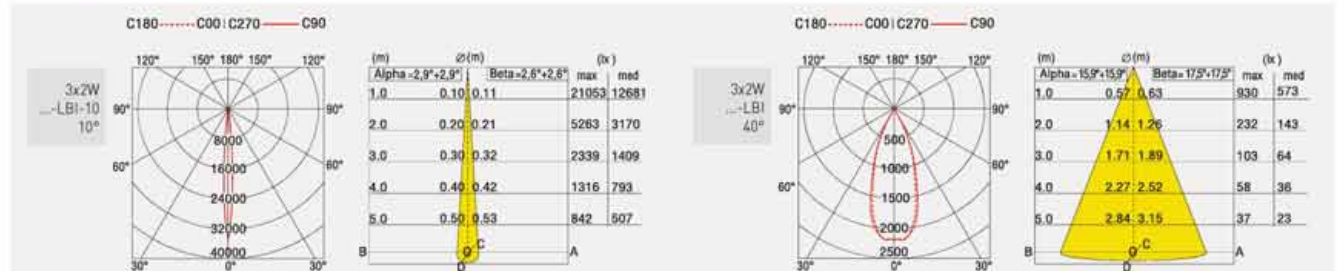
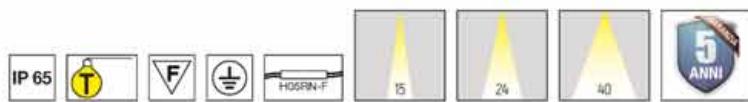

ALIMENTATORI-KIT RGB (se non in dotazione) da ordinare dalla sezione arancio - DRIVERS-RGB KITS (when not supplied) to be ordered from the section orange color

MONOLIGHT 140



- Corpo e staffa di ancoraggio in alluminio pressofuso.
- Verniciatura in polveri con pretrattamento speciale per esterni.
- Vetro di protezione temperato.
- Viteria in acciaio inox.
- Gruppo di alimentazione inserito nell'apparecchio.
- Guarnizioni e pressacavo di tenuta in gomma silconica.

- Body and wall bracket in die-cast aluminium.
- Powder coated with pretreatment for outdoor use.
- Tempered protection glass.
- Inox steel screws.
- Internal driver.
- Silicon rubber gaskets and cable gland.

LED COB		LED					SISTEMA-SYSTEM		
		W	lm	V	K	CRI	W	lm	$\frac{lm}{W}$
LUCE SIMMETRICA - SYMMETRIC LIGHT									
Br E5590-LBC-16									
Ne E5591-LBC-16		17W	2650	500mA	3000	>90	20W	2175	109
Gr E5592-LBC-16									
Br E5590-LBN-16									
Ne E5591-LBN-16		17W	2439	500mA	4000	>90	20W	2002	100
Gr E5592-LBN-16									
Br E5590-LBC-24									
Ne E5591-LBC-24		17W	2650	500mA	3000	>90	20W	2082	104
Gr E5592-LBC-24									
Br E5590-LBN-24									
Ne E5591-LBN-24		17W	2439	500mA	4000	>90	20W	1916	96
Gr E5592-LBN-24									
Br E5590-LBC-40									
Ne E5591-LBC-40		17W	2650	500mA	3000	>90	20W	2121	106
Gr E5592-LBC-40									
Br E5590-LBN-40									
Ne E5591-LBN-40		17W	2439	500mA	3000	>90	20W	1952	98
Gr E5592-LBN-40									

LED COB		LED					SISTEMA-SYSTEM		
		W	lm	V	K	CRI	W	lm	$\frac{lm}{W}$
LUCE ASIMMETRICA - ASYMMETRIC LIGHT									
Br E5590-LBC-AS									
Ne E5591-LBC-AS		17W	2345	500mA	3000	>90	20W	1764	88
Gr E5592-LBC-AS									
Br E5590-LBN-AS									
Ne E5591-LBN-AS		17W	2530	500mA	4000	>90	20W	1903	95
Gr E5592-LBN-AS									

OP. A richiesta - On request. E...-600179 versione con vetro di sicurezza a filo anello - flush glass version

disponibile - available

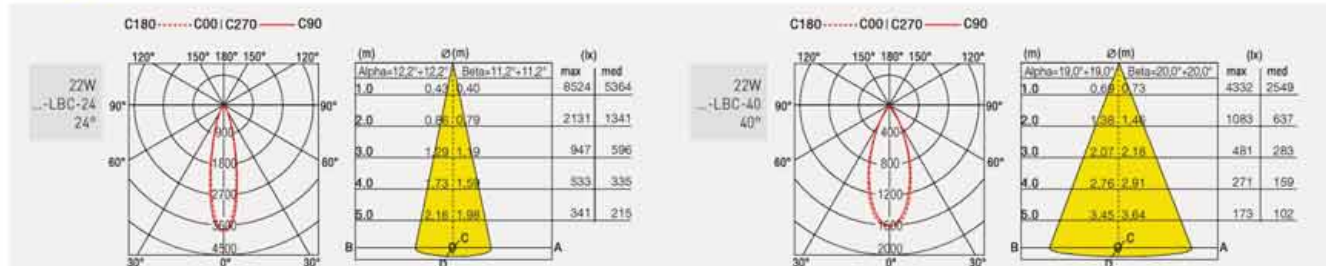
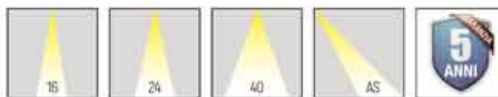

ALIMENTATORI-KIT RGB (se non in dotazione) da ordinare dalla sezione arancio - DRIVERS-RGB KITS (when not supplied) to be ordered from the section orange color





MONOLIGHT 175



- Corpo e staffa di ancoraggio in alluminio pressofuso.
- Verniciatura in polveri con pretrattamento speciale per esterni.
- Vetro di protezione temperato.
- Viteria in acciaio inox.
- Gruppo di alimentazione inserito nell'apparecchio.
- Guarnizioni e pressacavo di tenuta in gomma siliconica.
- Body and wall bracket in die-cast aluminium.
- Powder coated with pretreatment for outdoor use.
- Tempered protection glass.
- Inox steel screws.
- Internal driver.
- Silicon rubber gaskets and cable gland.

LED COB	Br	Ne	Gr	LED					SISTEMA-SYSTEM		
				W	lm	V	K	(CRI)	W	lm	(lm/W)
	E5680-LBC-16	E5681-LBC-16	E5682-LBC-16	36W	4900	220-240V [1050mA]	3000	>90	40W	4446	111
	E5680-LBN-16	E5681-LBN-16	E5682-LBN-16	36W	5280	220-240V [1050mA]	4000	>90	40W	4791	120
	E5680-LBC-24	E5681-LBC-24	E5682-LBC-24	36W	4900	220-240V [1050mA]	3000	>90	40W	4414	110
	E5680-LBN-24	E5681-LBN-24	E5682-LBN-24	36W	5280	220-240V [1050mA]	4000	>90	40W	4757	119
	E5680-LBC-40	E5681-LBC-40	E5682-LBC-40	36W	4900	220-240V [1050mA]	3000	>90	40W	4406	94
	E5680-LBN-40	E5681-LBN-40	E5682-LBN-40	36W	5280	220-240V [1050mA]	4000	>90	40W	4748	119

OP. A richiesta - On request: E...600180 versione con vetro di sicurezza a filo anello - flush glass version
 disponibile - available

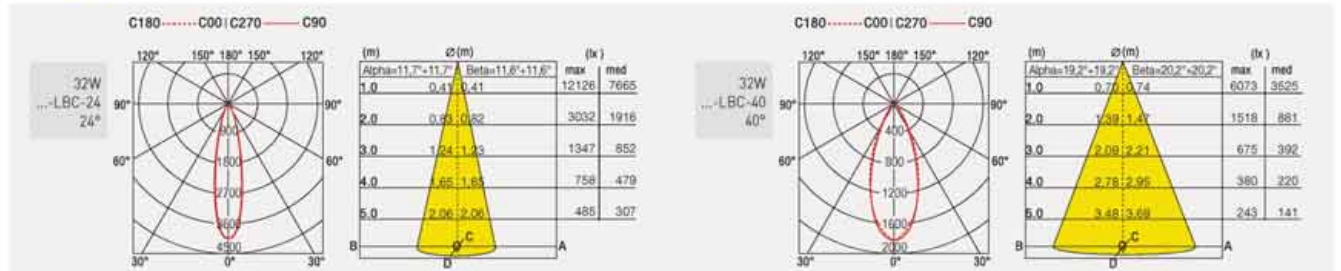
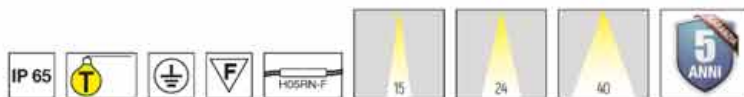

ALIMENTATORI-KIT RGB (se non in dotazione) da ordinare dalla sezione arancio - DRIVERS-RGB KITS (when not supplied) to be ordered from the section orange color





DOUBLELIGHT 105



- Corpo e staffa di ancoraggio in alluminio pressofuso.
- Verniciatura in polveri con pretrattamento speciale per esterni.
- Vetro di protezione temperato.
- Viteria in acciaio inox.
- Gruppo di alimentazione inserito nell'apparecchio.
- Guarnizioni e pressacavo di tenuta in gomma siliconica.

- Body and wall bracket in die-cast aluminium.
- Powder coated with pretreatment for outdoor use.
- Tempered protection glass.
- Inox steel screws.
- Internal driver.
- Silicon rubber gaskets and cable gland.

LED COB	Br	Ne	Gr	E	LED						SISTEMA-SYSTEM						
					W	lm	V	K	⚡	CRI	W	lm	lm/W				
	Br	E5553C-LBC-15															
	Ne	E5554C-LBC-15	15		2x12,3W	2x1040	350mA	3000		>90	26,6W	1788	67				
	Gr	E5555C-LBC-15															
	Br	E5553C-LBN-15															
	Ne	E5554C-LBN-15	15		2x12,3W	2x1120	350mA	4000		>90	26,6W	1925	73				
	Gr	E5555C-LBN-15															
	Br	E5553C-LBC-24															
	Ne	E5554C-LBC-24	24		2x12,9W	2x1430	350mA	3000		>90	27,8W	2412	81				
	Gr	E5555C-LBC-24															
	Br	E5553C-LBN-24															
	Ne	E5554C-LBN-24	24		2x12,9W	2x1450	350mA	4000		>90	27,8W	2446	88				
	Gr	E5555C-LBN-24															
	Br	E5553C-LBC-40															
	Ne	E5554C-LBC-40	40		2x12,9W	2x1310	350mA	3000		>90	27,8W	2270	76				
	Gr	E5555C-LBC-40															
	Br	E5553C-LBN-40															
	Ne	E5554C-LBN-40	40		2x12,9W	2x1430	350mA	4000		>90	27,8W	2387	86				
	Gr	E5555C-LBN-40															

OP. E...-LBL = LED blu-blue

E...-600178 A richiesta - On request: versione con vetro di sicurezza a filo anello - flush glass version

IP 65



ALIMENTATORI-KIT RGB (se non in dotazione) da ordinare dalla sezione arancio - DRIVERS-RGB KITS (when not supplied) to be ordered from the section orange color

outside



DOUBLELIGHT 140

- Corpo e staffa di ancoraggio in alluminio pressofuso.
- Verniciatura in polveri con pretrattamento speciale per esterni.
- Vetro di protezione temperato.
- Viteria in acciaio inox.
- Gruppo di alimentazione inserito nell'apparecchio.
- Guarnizioni e pressacavo di tenuta in gomma siliconica.

- Body and wall bracket in die-cast aluminium.
- Powder coated with pretreatment for outdoor use.
- Tempered protection glass.
- Inox steel screws.
- Internal driver.
- Silicon rubber gaskets and cable gland.



LED COB		LED					SISTEMA-SYSTEM				
		W	lm	V	K	CRI	W	lm	lm		
LUCE SIMMETRICA - SYMMETRIC LIGHT											
	Br	E5593-LBC-16									
	Ne	E5594-LBC-16	16	2x17W	2x2650	500mA	3000	>90	37W	4350	118
	Gr	E5595-LBC-16									
	Br	E5593-LBN-16									
	Ne	E5594-LBN-16	16	2x17W	2x2439	500mA	4000	>90	37W	4004	108
	Gr	E5595-LBN-16									
	Br	E5593-LBC-24									
	Ne	E5594-LBC-24	24	2x17W	2x2650	500mA	3000	>90	37W	4164	113
	Gr	E5595-LBC-24									
	Br	E5593-LBN-24									
	Ne	E5594-LBN-24	24	2x17W	2x2439	500mA	4000	>90	37W	3832	104
	Gr	E5595-LBN-24									
	Br	E5593-LBC-40									
	Ne	E5594-LBC-40	40	2x17W	2x2650	500mA	3000	>90	37W	4242	105
	Gr	E5595-LBC-40									
	Br	E5593-LBN-40									
	Ne	E5594-LBN-40	40	2x17W	2x2439	500mA	3000	>90	37W	3904	106
	Gr	E5595-LBN-40									

LED COB		LED					SISTEMA-SYSTEM				
		W	lm	V	K	CRI	W	lm	lm		
LUCE ASIMMETRICA - ASYMMETRIC LIGHT											
	Br	E5593-LBC-AS									
	Ne	E5594-LBC-AS		2x17W	2x2545	500mA	3000	>90	37W	3353	91
	Gr	E5595-LBC-AS									
	Br	E5593-LBN-AS									
	Ne	E5594-LBN-AS		2x17W	2x2530	500mA	4000	>90	37W	3616	98
	Gr	E5595-LBN-AS									

OP. A richiesta - On request: E...-600179 versione con vetro di sicurezza a filo anello - flush glass version disponibile - available

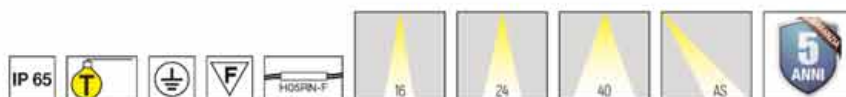

ALIMENTATORI-KIT RGB (se non in dotazione) da ordinare dalla sezione arancio - DRIVERS-RGB KITS (when not supplied) to be ordered from the section orange color



DOUBLELIGHT 175



- Corpo e staffa di ancoraggio in alluminio pressofuso.
- Verniciatura in polveri con pretrattamento speciale per esterni.
- Vetro di protezione temperato.
- Viteria in acciaio inox.
- Gruppo di alimentazione inserito nell'apparecchio.
- Guarnizioni e pressacavo di tenuta in gomma siliconica.

- Body and wall bracket in die-cast aluminium.
- Powder coated with pretreatment for outdoor use.
- Tempered protection glass.
- Inox steel screws.
- Internal driver.
- Silicon rubber gaskets and cable gland.

LED COB	Br	Ne	Gr	LED	W	lm	V	K	CRI	SISTEMA-SYSTEM		
										W	lm	W
	E5683-LBC-16	E5684-LBC-16	E5685-LBC-16	15	2x36W	2x4900	220-240V (1050mA)	3000	>90	76W	8892	117
	E5683-LBN-16	E5684-LBN-16	E5685-LBN-16	15	2x36W	2x5280	220-240V (1050mA)	4000	>90	76W	9561	125
	E5683-LBC-25	E5684-LBC-25	E5685-LBC-25	25	2x36W	2x4900	220-240V (1050mA)	3000	>90	76W	8829	116
	E5683-LBN-25	E5684-LBN-25	E5685-LBN-25	25	2x36W	2x5280	220-240V (1050mA)	4000	>90	76W	9514	125
	E5683-LBC-40	E5684-LBC-40	E5685-LBC-40	40	2x36W	2x4900	220-240V (1050mA)	3000	>90	76W	8812	116
	E5683-LBN-40	E5684-LBN-40	E5685-LBN-40	40	2x36W	2x5280	220-240V (1050mA)	4000	>90	76W	9496	125

OP. A richiesta - On request: E...-600180 versione con vetro di sicurezza a filo anello - flush glass version
disponibile - available



IP 65



outside

ALIMENTATORI-KIT RGB (se non in dotazione) da ordinare dalla sezione arancio - DRIVERS-RGB KITS (when not supplied) to be ordered from the section orange color





QUADRO MONO



- Corpo e staffa di ancoraggio in alluminio pressofuso.
 - Verniciatura in polveri con pretrattamento speciale per esterni.
 - Vetro di protezione temperato.
 - Viteria in acciaio inox.
 - Gruppo di alimentazione inserito nell'apparecchio.
 - Ottica in alluminio purissimo.
 - Guarnizione in gomma siliconica.
- Body and wall bracket in die-cast aluminium.
 - Powder coated with pre-treatment for outdoor use.
 - Tempered protection glass.
 - Inox steel screws.
 - Internal driver.
 - Very pure aluminium optic.
 - Silicon rubber gaskets.

LED COB				LED					SYSTEM-SYSTEM			
	15	40	60	W	lm	V	K	CRI	W	lm	lp	
Br	E5375-LBC-15	E5375-LBC-40	E5375-LBC-60	37W	5300	220-240V (1050mA)	3000	>90	41W	5268	128	(16°)
Ne	E5376-LBC-15	E5376-LBC-40	E5376-LBC-60							4215	103	(40°)
Gr	E5377-LBC-15	E5377-LBC-40	E5377-LBC-60							4659	114	(60°)
Br	E5375-LBN-15	E5375-LBN-40	E5375-LBN-60	37W	5670	220-240V (1050mA)	4000	>90	41W	5636	137	(16°)
Ne	E5376-LBN-15	E5376-LBN-40	E5376-LBN-60							4508	110	(40°)
Gr	E5377-LBN-15	E5377-LBN-40	E5377-LBN-60							4984	122	(60°)

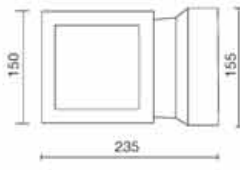
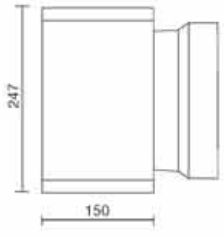

OP: A richiesta - On request: Led con temperatura di COLORE 2700K - Temperature Led COLOUR 2700K disponibile - available 

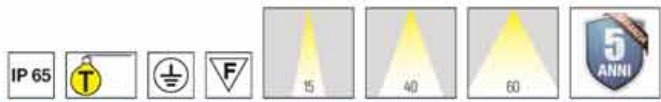

ALIMENTATORI-KIT RGB (se non in dotazione) da ordinare dalla sezione arancio - DRIVERS-RGB KITS (when not supplied) to be ordered from the section orange color





**QUADRO DOUBLE**

- Corpo e staffa di ancoraggio in alluminio pressofuso.
- Verniciatura in polveri con pretrattamento speciale per esterni.
- Vetro di protezione temperato.
- Viteria in acciaio inox.
- Gruppo di alimentazione inserito nell'apparecchio.
- Ottica in alluminio purissimo.
- Guarnizione in gomma siliconica.

- Body and hanging bracket in die-cast aluminium.
- Powder coated with pre-treatment for outdoor use.
- Tempered protection glass.
- Inox steel screws.
- Built-in driver.
- Very pure aluminium optic.
- Silicon rubber gaskets.

LED COB	15	40	60	LED					SYSTEM-SYSTEM			
				W	lm	V	K	CRI	W	lm	lp	
Br	E5381-LBC-15	E5381-LBC-40	E5381-LBC-60							10536	135	[16°]
Ne	E5382-LBC-15	E5382-LBC-40	E5382-LBC-60	2x37W	2x5300	220-240V [1050mA]	3000	>90	78W	8429	108	[40°]
Gr	E5383-LBC-15	E5383-LBC-40	E5383-LBC-60							9317	119	[60°]
Br	E5381-LBN-15	E5381-LBN-40	E5381-LBN-60							11272	145	[16°]
Ne	E5382-LBN-15	E5382-LBN-40	E5382-LBN-60	2x37W	2x5670	220-240V [1050mA]	4000	>90	78W	9018	116	[40°]
Gr	E5383-LBN-15	E5383-LBN-40	E5383-LBN-60							9968	128	[60°]

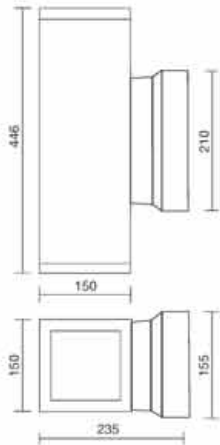

OP. A richiesta - On request: versione con lampade a Led 2x22W - Led lamps version 2x22W

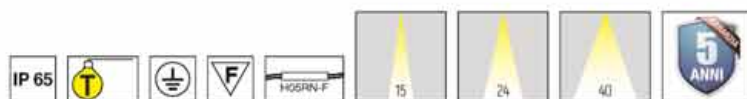

ALIMENTATORI-KIT RGB (se non in dotazione) da ordinare dalla sezione arancio - DRIVERS-RGB KITS (when not supplied) to be ordered from the section orange color



MICRO VARIANT

- Corpo interamente in alluminio.
- Verniciatura in polveri con pretrattamento speciale per esterni.
- Vetro di protezione temperato extrachiario a filo.
- Riflettore con lenti in metacrilato.
- Guarnizioni di tenuta in gomma silconica.
- Pressacavo in gomma silconica.
- Viteria in acciaio inox.

- Housing made of die-cast aluminium.
- Powder coated after pretreatment for outdoor use.
- Extraclear protection glass.
- Reflector with metacrylate lenses.
- Silicone rubber gasket.
- Silicone rubber cable gland.
- Stainless steel screws.



		LED					SISTEMA-SYSTEM		
		W	lm	V	K	CRI	W	lm	lm/W
	MONO EMISSIONE MONO EMISSION Br E5850-LBC Ne E5851-LBC Gr E5852-LBC	4x1,2W	400	220-240V [350mA]	3000	>90	5,8W	347	60
		4x1,2W	420	220-240V [350mA]	4000	>90	5,8W	364	63
		4x1,2W	440	220-240V [350mA]	6000	>90	5,8W	381	66
		8x1,2W	2x400	220-240V [350mA]	3000	>90	10,6W	682	65
		8x1,2W	2x420	220-240V [350mA]	4000	>90	10,6W	726	68
		8x1,2W	2x440	220-240V [350mA]	6000	>90	10,6W	761	72
	DOPPIA EMISSIONE DOUBLE EMISSION Br E5853-LBC Ne E5854-LBC Gr E5855-LBC	4x1,2W	420	220-240V [350mA]	4000	>90	5,8W	364	63
		4x1,2W	440	220-240V [350mA]	6000	>90	5,8W	381	66
		8x1,2W	2x400	220-240V [350mA]	3000	>90	10,6W	682	65
		8x1,2W	2x420	220-240V [350mA]	4000	>90	10,6W	726	68
		8x1,2W	2x440	220-240V [350mA]	6000	>90	10,6W	761	72

OP. E...-LBI = LED blu-blue



outside

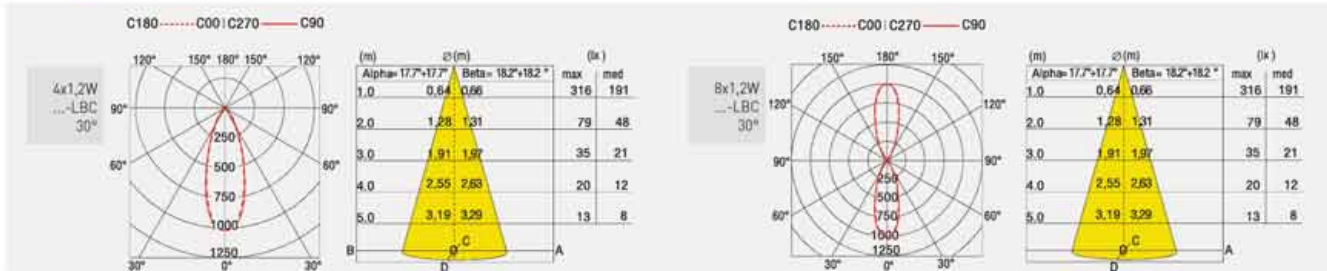

ALIMENTATORI-KIT RGB (se non in dotazione) da ordinare dalla sezione arancio - DRIVERS-RGB KITS (when not supplied) to be ordered from the section orange color



MINI VARIANT

- Corpo interamente in alluminio.
- Verniciatura in polveri con pretrattamento speciale per esterni.
- Vetro di protezione.
- Guarnizioni di tenuta in gomma siliconica.
- Pressacavo in gomma siliconica.
- Viteria in acciaio inox.

- Housing made of die-cast aluminium.
- Powder coated after pretreatment for outdoor use.
- Protection glass.
- Silicone rubber gasket.
- Silicone rubber cable gland.
- Stainless steel screws.



		LED					SYSTEM-SYSTEM		
		W	lm	V	K	CRI	W	lm	W
	MONO EMISSIONE MONO EMISSION Br E5810-LBC Ne E5811-LBC Gr E5812-LBC 8,00 Kg	6x1,2W	540	220-240V (350mA)	3000	>90	8W	374	47
		6x1,2W	570	220-240V (350mA)	4000	>90	8W	395	49
		DOPPIA EMISSIONE DOUBLE EMISSION Br E5830-LBC Ne E5831-LBC Gr E5832-LBC 6,00 Kg							
	12x1,2W	2x540	220-240V (350mA)	3000	>90	15W	745	50	
	12x1,2W	2x570	220-240V (350mA)	4000	>90	15W	786	52	
									52

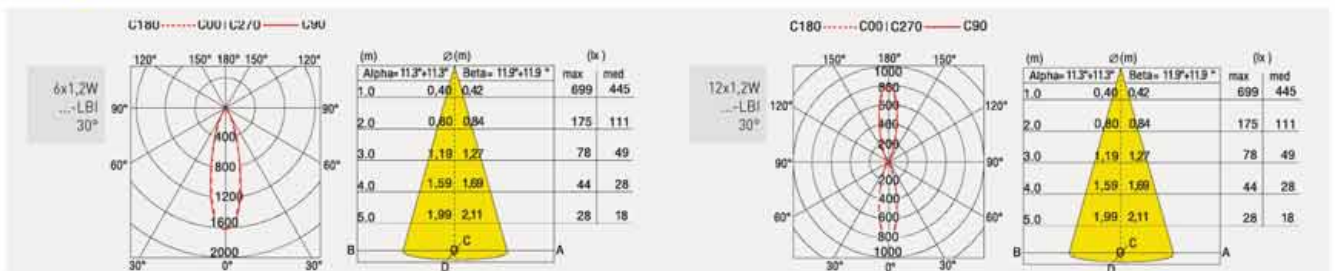

ALIMENTATORI-KIT RGB (se non in dotazione) da ordinare dalla sezione arancio - DRIVERS-RGB KITS (when not supplied) to be ordered from the section orange color

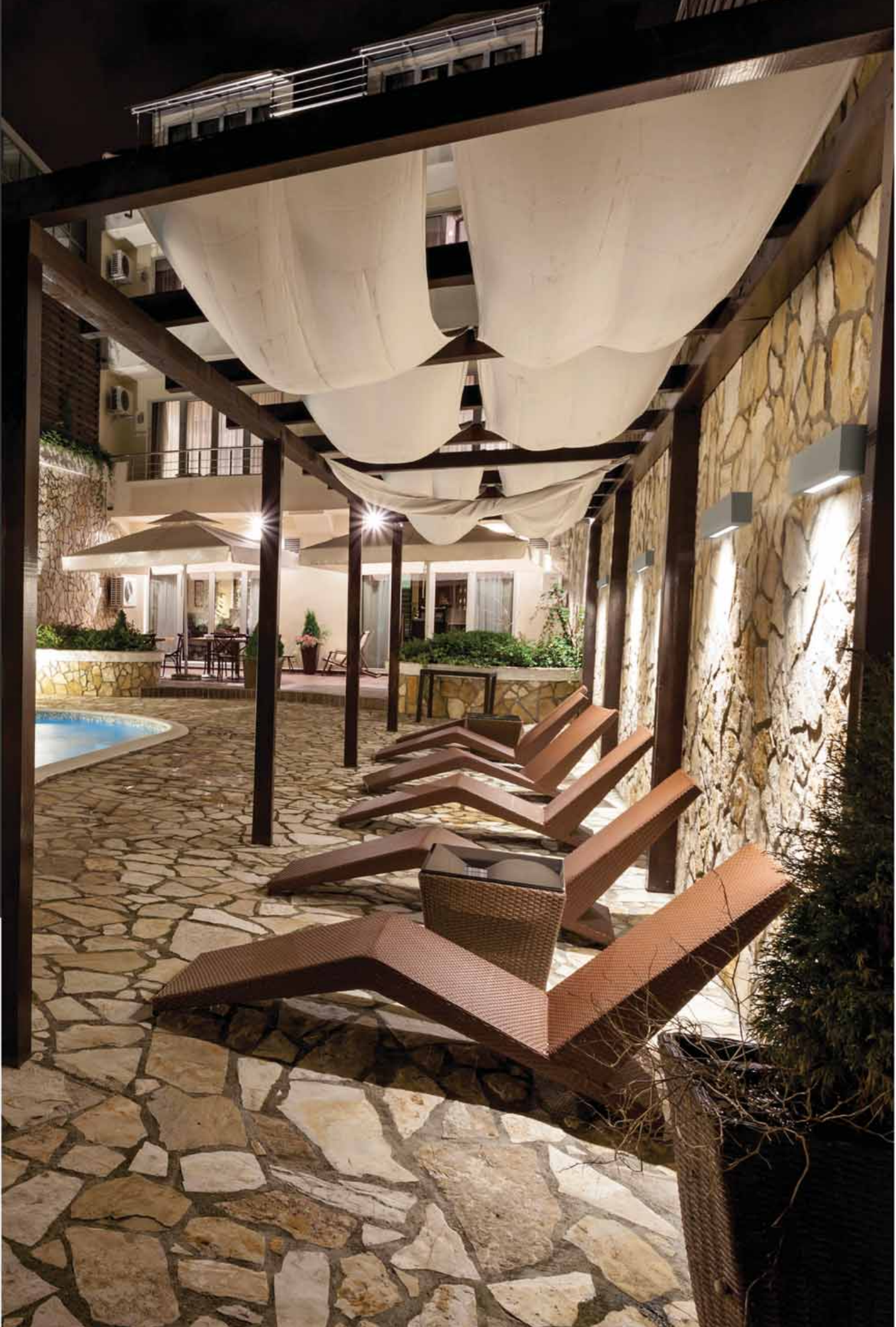



QUADERS



- Corpo in pressofusione di alluminio.
- Verniciatura in polveri di poliestere con trattamento speciale per esterni.
- Guarnizioni in gomma siliconica.
- Schermo in policarbonato opale
- Pressacavo in gomma siliconica PG11.

- Housing of die-cast aluminium.
- Specially treated polyester powder coating for exterior.
- Silicon rubber gaskets.
- Opal polycarbonate diffuser.
- Cable gland in silicon rubber PG11.

	LED					SYSTEM-SYSTEM		
	W	lm	V	K	CRI	W	lm	lm/W
 MONO EMISSIONE - MONO EMISSION Br E8830-LBC Ne E8831-LBC Gr E8832-LBC	10W	1150	220-240V (500mA)	3000	>90	11W	615	56
	10W	1250	220-240V (500mA)	4000	>90	11W	670	61
								
 DOPPIA EMISSIONE - DOUBLE EMISSION Br E8820-LBC Ne E8821-LBC Gr E8822-LBC	2x10W	2300	220-240V (500mA)	3000	>90	22W	1220	56
	2x10W	2500	220-240V (500mA)	4000	>90	22W	1340	61
								

OP. A richiesta - On request; disponibile - available 

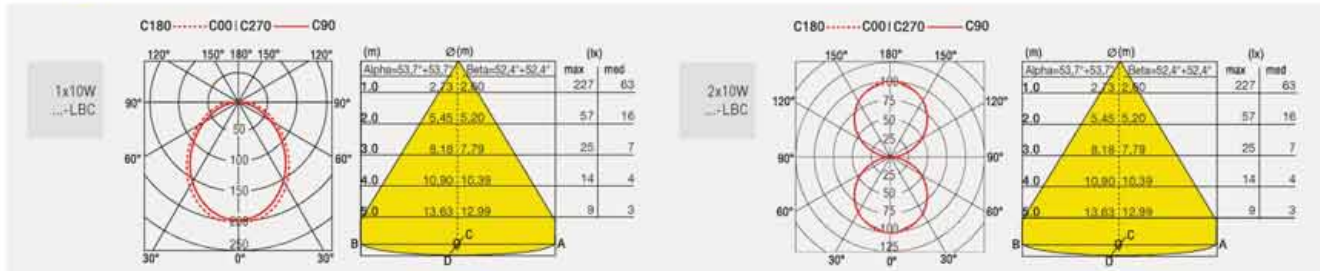

ALIMENTATORI-KIT RGB (se non in dotazione) da ordinare dalla sezione arancio - DRIVERS-RGB KITS (when not supplied) to be ordered from the section orange color



NEW QUARTO DI SFERA



- Corpo in pressofusione di alluminio.
- Verniciatura in polveri con pretrattamento speciale per esterni.
- Vetro di protezione opale.
- Driver integrato.
- Die-cast aluminium body.
- Powder coated after pretreatment for outdoor use.
- Opal protection glass.
- Built-in driver.

	ON-OFF	LED					SISTEMA-SYSTEM			
		W	lm	V	K	CRI	W	lm	lm/W	
	Br E8540-LBC	tot. 35W SMD	3150	220-240V (700mA)	3000	>90	39W	1279	33	
	Ne E8541-LBC									
	Gr E8542-LBC									
	Br E8540-LBN	tot. 35W SMD	3500	220-240V (700mA)	4000	>90	39W	1421	36	
	Ne E8541-LBN									
	Gr E8542-LBN									
	Br E8540-LBI	tot. 35W SMD	3500	220-240V (700mA)	6000	>90	39W	1421	36	
	Ne E8541-LBI									
	Gr E8542-LBI									
	EMERGENZA - EMERGENCY									
	Br E8540-LBC-EM	1h	17W	1700	220-240V (350mA)	3000	>90	20W	690	34
	Ne E8541-LBC-EM									
Gr E8542-LBC-EM										
	Br E8540-LBN-EM	1h	17W	1750	220-240V (350mA)	4000	>90	20W	710	35
	Ne E8541-LBN-EM									
	Gr E8542-LBN-EM									
	Br E8540-LBI-EM	1h	17W	1750	220-240V (350mA)	6000	>90	20W	710	35
	Ne E8541-LBI-EM									
	Gr E8542-LBI-EM									

NB. Funzionamento in emergenza 1 h - Rendimento 26% del flusso nominale
 Funzionamento in emergenza 1 h - Rendimento 26% del flusso nominale



ALIMENTATORI-KIT RGB (se non in dotazione) da ordinare dalla sezione arancio - DRIVERS-RGB KITS (when not supplied) to be ordered from the section orange color



MOON



- Corpo in pressofusione di alluminio.
- Verniciatura in polveri con pretrattamento speciale per esterni.
- Diffusore in policarbonato resistente agli urti stabilizzato ai raggi UV.
- Viteria in acciaio inox.
- Gruppo di alimentazione elettronico incorporato.
- Guarnizione in gomma siliconica.

- Die-cast aluminium body.
- Powder coated after pretreatment for outdoor use.
- Shock resistant and UV stabilized polycarbonate diffuser.
- Inox steel screws.
- Build-in driver.
- Gasket in silicone rubber.

	LED	SISTEMA-SYSTEM					
		W	lm	lm/W			
ON-OFF							
Br E5420-LBC	12W 1200	220-240V [350mA]	3000	>90	14W	763	55
Ne E5421-LBC							
Gr E5422-LBC							
Br E5420-LBN	12W 1350	220-240V [350mA]	4000	>90	14W	858	61
Ne E5421-LBN							
Gr E5422-LBN							
Br E5420-LBI	12W 1350	220-240V [350mA]	6000	>90	14W	858	61
Ne E5421-LBI							
Gr E5422-LBI							
EMERGENZA - EMERGENCY							
Br E5420-LBC-EM	1h 9,6W 1140	220-240V [350mA]	3000	>90	10,6W	642	61
Ne E5421-LBC-EM							
Gr E5422-LBC-EM							
Br E5420-LBN-EM	1h 9,8W 1140	220-240V [350mA]	4000	>90	10,6W	642	61
Ne E5421-LBN-EM							
Gr E5422-LBN-EM							

NB. Funzionamento in emergenza 1h - Rendimento 11% del flusso nominale
 Funzionamento in emergenza 1h - Rendimento 11% del flusso nominale

	LED	SISTEMA-SYSTEM					
		W	lm	lm/W			
ON-OFF							
Br E5430-LBC	12W 1200	220-240V [350mA]	3000	>90	14W	439	31
Ne E5431-LBC							
Gr E5432-LBC							
Br E5430-LBN	12W 1350	220-240V [350mA]	4000	>90	14W	494	35
Ne E5431-LBN							
Gr E5432-LBN							
Br E5430-LBI	12W 1350	220-240V [350mA]	6000	>90	14W	494	35
Ne E5431-LBI							
Gr E5432-LBI							
EMERGENZA - EMERGENCY							
Br E5430-LBC-EM	1h 9,6W 1140	220-240V [350mA]	3000	>90	10,6W	417	39
Ne E5431-LBC-EM							
Gr E5432-LBC-EM							
Br E5430-LBN-EM	1h 9,6W 1140	220-240V [350mA]	4000	>90	10,6W	417	39
Ne E5431-LBN-EM							
Gr E5432-LBN-EM							

NB. Funzionamento in emergenza 1h - Rendimento 11% del flusso nominale
 Funzionamento in emergenza 1h - Rendimento 11% del flusso nominale

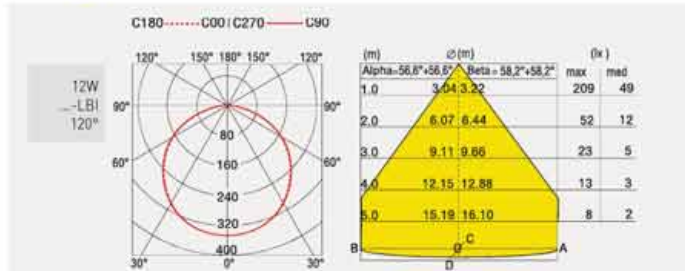

ALIMENTATORI-KIT RGB (se non in dotazione) da ordinare dalla sezione arancio - DRIVERS-RGB KITS (when not supplied) to be ordered from the section orange color

CERKIO XS

- Corpo in pressofusione di alluminio.
- Verniciatura in polveri con pretrattamento speciale per esterni.
- Diffusore in policarbonato resistente agli urti stabilizzato ai raggi UV.
- Viteria in acciaio inox.
- Gruppo di alimentazione elettronico incorporato.
- Guarnizione in gomma silconica.

- Die-cast aluminium body.
- Powder coated after pretreatment for outdoor use.
- Shock resistant and UV stabilized polycarbonate diffuser.
- Inox steel screws.
- Build-in driver.
- Gasket in silicone rubber.



Icona	LED	SISTEMA-SYSTEM				
		W	lm	V	K	CRI
ON-OFF						
Br	E5446-LBC					
Ne	E5447-LBC	12W	1200	220-240V [350mA]	3000	>90
Gr	E5448-LBC					
Br	E5446-LBN					
Ne	E5447-LBN	12W	1350	220-240V [350mA]	4000	>90
Gr	E5448-LBN					
Br	E5446-LBI					
Ne	E5447-LBI	12W	1350	220-240V [350mA]	6000	>90
Gr	E5448-LBI					
EMERGENZA - EMERGENCY						
Br	E5446-LBC-EM					
Ne	E5447-LBC-EM	9,6W	1140	220-240V [350mA]	3000	>90
Gr	E5448-LBC-EM					
Br	E5446-LBN-EM					
Ne	E5447-LBN-EM	9,6W	1140	220-240V [350mA]	4000	>90
Gr	E5448-LBN-EM					
Br	E5446-LBI-EM					
Ne	E5447-LBI-EM	9,6W	1140	220-240V [350mA]	6000	>90
Gr	E5448-LBI-EM					

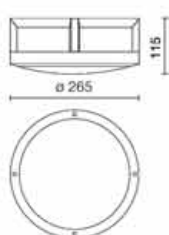

NB. Funzionamento in emergenza 1 h - Rendimento 11% del flusso nominale
 Funzionamento in emergenza 1 h - Rendimento 11% del flusso nominale



outside

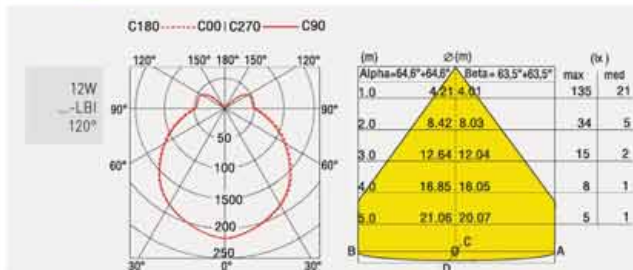

ALIMENTATORI-KIT RGB (se non in dotazione) da ordinare dalla sezione arancio - DRIVERS-RGB KITS (when not supplied) to be ordered from the section orange color



CERKIO XL

- Corpo in pressofusione di alluminio.
- Verniciatura in polveri con pretrattamento speciale per esterni.
- Diffusore in policarbonato resistente agli urti stabilizzato ai raggi UV.
- Viteria in acciaio inox.
- Gruppo di alimentazione elettronico incorporato.
- Guarnizione in gomma siliconica.

- Die-cast aluminium body.
- Powder coated after pretreatment for outdoor use.
- Shock resistant and UV stabilized polycarbonate diffuser.
- Inox steel screws.
- Build-in driver.
- Gasket in silicone rubber.



		LED					SISTEMA-SYSTEM		
		W	lm	V	K	CRI	W	lm	lm
	DN-OFF								
	Br E5400-LBC								
	Ne E5401-LBC	19W	2300	220-240V (700mA)	3000	>90	22W	1265	86
	Gr E5402-LBC								
	Br E5400-LBN	19W	2400	220-240V (700mA)	4000	>90	22W	1320	91
	Ne E5401-LBN								
	Gr E5402-LBN								
	DIM 1-10V								
	Br E5400-LBC-DIM								
	Ne E5401-LBC-DIM	19W	2300	220-240V (700mA)	3000	>90	22W	1265	86
	Gr E5402-LBC-DIM								
	Br E5400-LBN-DIM	19W	2400	220-240V (700mA)	4000	>90	22W	1320	91
	Ne E5401-LBN-DIM								
	Gr E5402-LBN-DIM								
	DIM-DALI/PUSH								
	Br E5400-LBC-DA								
	Ne E5401-LBC-DA	19W	2300	220-240V (700mA)	3000	>90	22W	1265	86
	Gr E5402-LBC-DA								
	Br E5400-LBN-DA	19W	2400	220-240V (700mA)	4000	>90	22W	1320	91
	Ne E5401-LBN-DA								
	Gr E5402-LBN-DA								

IK10
3.50

OP. A richiesta - On request: 1 h



ALIMENTATORI-KIT RGB (se non in dotazione) da ordinare dalla sezione arancio - DRIVERS-RGB KITS (when not supplied) to be ordered from the section orange color







- Corpo in policarbonato.
- Diffusore in policarbonato opale.
- Guarnizioni in gomma siliconica.
- Passacavo in gomma siliconica.
- Led durata utile: 50.000 (h) L80 B20.

- Polycarbonate body.
- Opal polycarbonate diffuser.
- Silicon rubber gasket.
- Silicon rubber cable gland.
- Led life: 50.000 (h) L80 B20.

FENIX



	LED	SYSTEM-SYSTEM		
		W	lm	lm/W
Bi Ne	E8500-LBC E8501-LBC	15W	1580	53
Bi Ne	E8500-LBN E8501-LBN	15W	1710	57

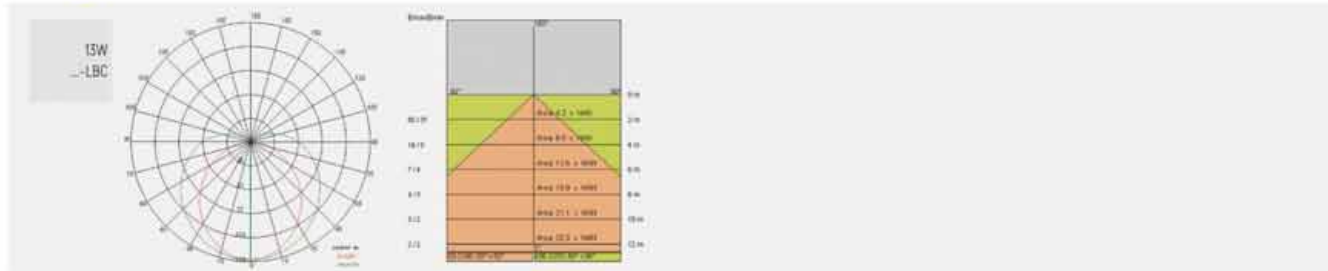
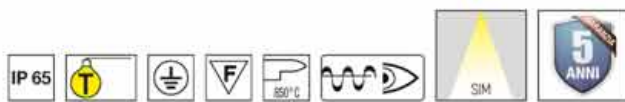
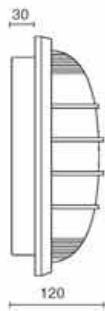
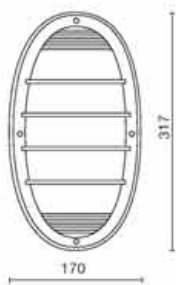

ALIMENTATORI-KIT RGB (se non in dotazione) da ordinare dalla sezione arancio - DRIVERS-RGB KITS (when not supplied) to be ordered from the section orange color



SOLID



- Corpo in pressofusione di alluminio.
- Verniciatura in polveri con pretrattamento speciale per esterni.
- Schermo in policarbonato opale.
- Guarnizioni in gomma silconica.
- Die-cast aluminium body.
- Powder coated after pretreatment for outdoor use.
- Polycarbonate diffuser.
- Silicone rubber gasket.

	LED						SYSTEM-SYSTEM		
	W	lm	V	K	CRI	W	lm	lm/W	
	TUTTO SCHERMO FULL SCREEN								
	Br E5385-LBC	19,4W	2320	220-240V	3000	>90	22,4W	1287	57
	Ne E5386-LBC			(700mA)					
	Gr E5387-LBC								
	Br E5385-LBN	19,4W	2440	220-240V	4000	>90	22,4W	1585	71
	Ne E5386-LBN			(700mA)					
	Gr E5387-LBN								
	Br E5385-LBC-EM	19,4W	2320	220-240V	3000	>90	22,4W	1287	57
	Ne E5386-LBC-EM			(700mA)					
	Gr E5387-LBC-EM								
	Br E5385-LBN-EM	19,4W	2440	220-240V	3000	>90	22,4W	1585	71
	Ne E5386-LBN-EM			(700mA)					
	Gr E5387-LBN-EM								
Funzionamento in emergenza - Flusso 200 lumene - Autonomia 1h - Emergency mode - Lumen flux 200 - Operation time 1h									
	DOPPIA ACCENSIONE DOUBLE LIGHTING								
	Br E5393-LBC	19,4W	2320	220-240V	3000	>90	22,4W	1287	57
	Ne E5394-LBC	(18W)*	(1933)*	(700mA)					
	Gr E5395-LBC	(3W)**	(386)**						
*accensione 1 - lighting 1 **accensione 2 - lighting 2									
	Br E5393-LBN	19,4W	2440	220-240V	4000	>90	22,4W	1585	71
	Ne E5394-LBN	(18W)*	(2033)*	(700mA)					
	Gr E5395-LBN	(3W)**	(406)**						
*accensione 1 - lighting 1 **accensione 2 - lighting 2									
	Br E5390-LBC	19,4W	2320	220-240V	3000	>90	22,4W	839	37
	Ne E5391-LBC			(700mA)					
	Gr E5392-LBC								
	Br E5390-LBN	19,4W	2440	220-240V	4000	>90	22,4W	891	40
	Ne E5391-LBN			(700mA)					
	Gr E5392-LBN								
	Br E5390-LBC-EM	19,4W	2320	220-240V	3000	>90	22,4W	839	37
	Ne E5391-LBC-EM			(700mA)					
	Gr E5392-LBC-EM								
	Br E5390-LBN-EM	19,4W	2440	220-240V	4000	>90	22,4W	891	40
	Ne E5391-LBN-EM			(700mA)					
	Gr E5392-LBN-EM								
Funzionamento in emergenza - Flusso 200 lumene - Autonomia 1h - Emergency mode - Lumen flux 200 - Operation time 1h									
	DOPPIA ACCENSIONE DOUBLE LIGHTING								
	Br E5396-LBC	21W	2320	220-240V	3000	>90	22,4W	839	37
	Ne E5397-LBC	(18W)*	(1933)*	(700mA)					
	Gr E5398-LBC	(3W)**	(386)**						
*accensione 1 - lighting 1 **accensione 2 - lighting 2									
	Br E5396-LBN	21W	2440	220-240V	4000	>90	22,4W	891	37
	Ne E5397-LBN	(18W)*	(2033)*	(700mA)					
	Gr E5398-LBN	(3W)**	(406)**						
*accensione 1 - lighting 1 **accensione 2 - lighting 2									



outside

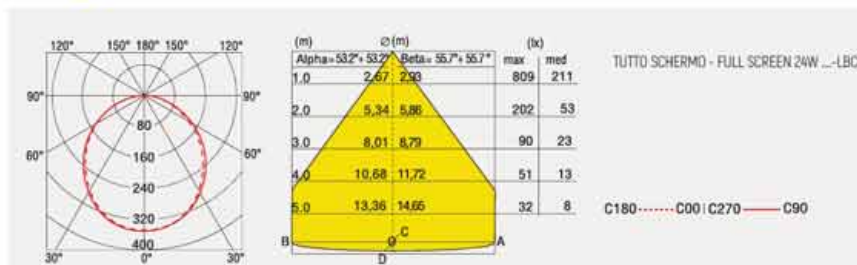

ALIMENTATORI-KIT RGB (se non in dotazione) da ordinare dalla sezione arancio - DRIVERS-RGB KITS (when not supplied) to be ordered from the section orange color

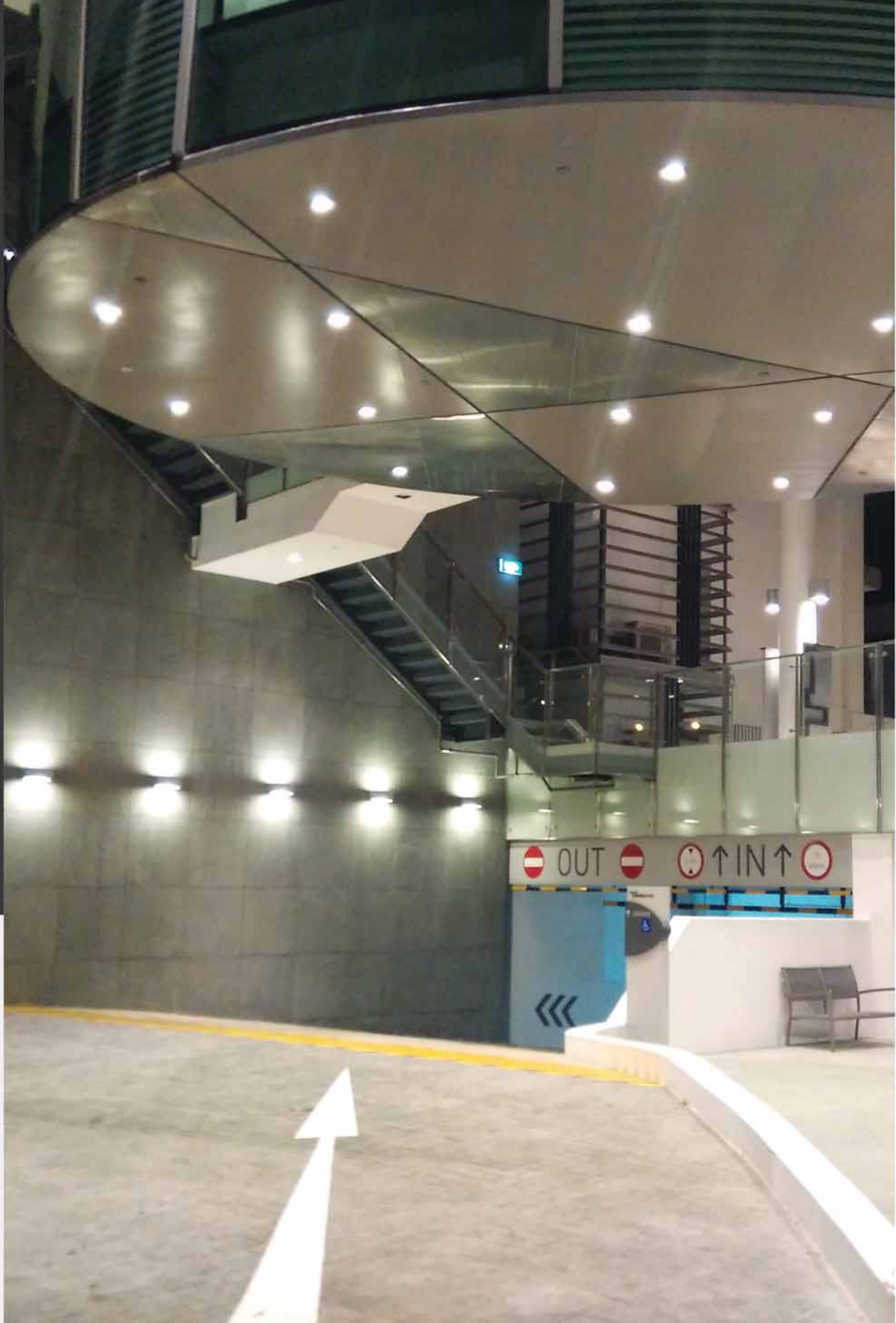

MINI MISTRAL LED



- Corpo in pressofusione di alluminio.
- Verniciatura in polveri di poliestere con trattamento speciale.
- Guarnizioni in gomma siliconica.
- Schermo vetro satinato temperato.
- Pressacavo in gomma siliconica PG11.
- Die-cast aluminium body.
- Specially treated polyester powder coating for exterior.
- Silicon rubber gaskets.
- Satined and tempered diffuser glass.
- Silicon rubber cable gland in PG11.



	LED					SISTEMA-SYSTEM		
	W	lm	V	K	CRI	W	lm	lm/W
MONO EMISSIONE- MONO EMISSION								
Br E8805-LBC	9W	1150	220-240V (400mA)	3000	>90	10W	611	61
Ne E8806-LBC								
Gr E8807-LBC								
Br E8805-LBN	9W	1250	220-240V (400mA)	4000	>90	10W	664	66
Ne E8806-LBN								
Gr E8807-LBN								
DOPPIA EMISSIONE- DOUBLE EMISSION								
Br E8800-LBC	2x9W	2300	220-240V (400mA)	3000	>90	19W	1216	64
Ne E8801-LBC								
Gr E8802-LBC								
Br E8800-LBN	2x9W	2500	220-240V (400mA)	4000	>90	19W	1321	69
Ne E8801-LBN								
Gr E8802-LBN								

A richiesta alimentazione separata doppia accensione
Separate power supply on request, double switch

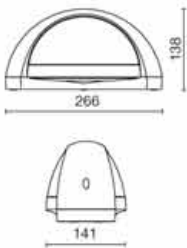

OP: A richiesta: versioni dimmerabili 1-10V/PUSH/DALI - On request: dimmable versions with 1-10V/PUSH/DALI

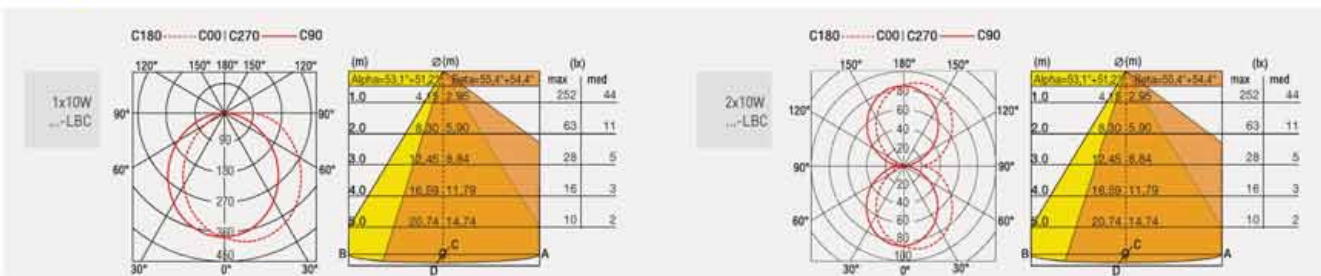

ALIMENTATORI-KIT RGB (se non in dotazione) da ordinare dalla sezione arancio - DRIVERS-RGB KITS (when not supplied) to be ordered from the section orange color



MISTRAL LED



- Corpo in pressofusione di alluminio.
- Verniciatura in polveri di poliestere con trattamento speciale per esterni (sabbatura, decappaggio, n.3 lavaggi, fluorozirconatura, fondo in polveri epossidiche, finitura di superficie in polvere poliestere).
- Guarnizioni in gomma siliconica.
- Schermo vetro satinato.
- Pressacavo in gomma siliconica PG11.

- Housing of die-cast aluminium.
- Specially treated polyester powder coating for exterior (Pickling, blasting, n3 washings, epoxy bottom, polyester powder surface finish).
- Silicon rubber gaskets.
- Satined diffuser glass.
- Cable gland in silicon rubber PG11.

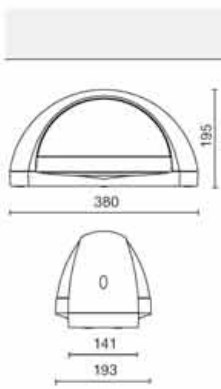

	LED					SYSTEM-SYSTEM		
	W	lm	V	K	CRI	W	lm	lm/W
MONO EMISSIONE- MONO EMISSION								
Br E8650-LBC								
Ne E8651-LBC	22W	2400	220-240V (500mA)	3000	>90	25W	1269	51
Gr E8652-LBC								
Br E8650-LBN								
Ne E8651-LBN	22W	2700	220-240V (500mA)	4000	>90	25W	1428	57
Gr E8652-LBN								
DOPPIA EMISSIONE- DOUBLE EMISSION								
Br E8600-LBC								
Ne E8601-LBC	2x22W	4800	220-240V (500mA)	3000	>90	48W	2540	53
Gr E8602-LBC								
Br E8600-LBN								
Ne E8601-LBN	2x22W	5400	220-240V (500mA)	4000	>90	48W	2858	59
Gr E8602-LBN								

A richiesta alimentazione separata doppia accensione
Separate power supply on request, double switch

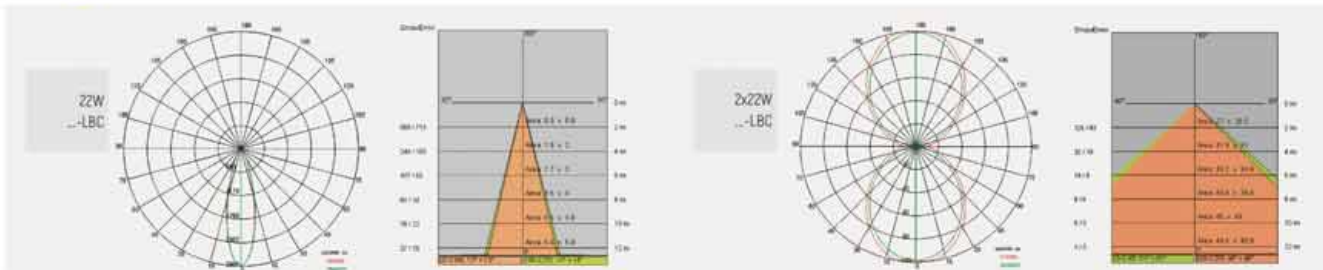

ALIMENTATORI-KIT RGB (se non in dotazione) da ordinare dalla sezione arancio - DRIVERS-RGB KITS (when not supplied) to be ordered from the section orange color





QUADRO CEILING

- Corpo e staffa di ancoraggio in alluminio pressofuso.
- Verniciatura in polveri con pretrattamento speciale per esterni.
- Viteria in acciaio inox.
- Vetro di protezione temperato.
- Gruppo di alimentazione inserito nell'apparecchio.
- Guarnizioni e pressacavo di tenuta in gomma siliconica.

- Body and ceiling bracket in die-cast aluminium.
- Powder coated with pretreatment for outdoor use.
- Inox steel screws.
- Tempered protection glass.
- Built-in driver.
- Silicon rubber gaskets and cable gland.



LED COB	15	40	60	LED					SYSTEM-SYSTEM				
				W	lm	V	K	CRI	W	lm	W		
Br	E5357-LBC-15	E5357-LBC-40	E5357-LBC-60										
Ne	E5358-LBC-15	E5358-LBC-40	E5358-LBC-60	37W	5300	220-240V [1050mA]	3000	>90	41W	5268	128	(16°)	
Gr	E5359-LBC-15	E5359-LBC-40	E5359-LBC-60							4215	103	(40°)	
										4659	114	(60°)	
Br	E5357-LBN-15	E5357-LBN-40	E5357-LBN-60										
Ne	E5358-LBN-15	E5358-LBN-40	E5358-LBN-60	37W	5670	220-240V [1050mA]	4000	>90	41W	5636	137	(16°)	
Gr	E5359-LBN-15	E5359-LBN-40	E5359-LBN-60							4509	110	(40°)	
										4984	122	(60°)	

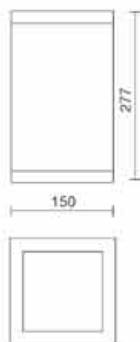

OP. A richiesta - On request disponibile - available

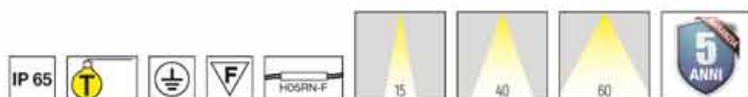

ALIMENTATORI-KIT RGB (se non in dotazione) da ordinare dalla sezione arancio - DRIVERS-RGB KITS (when not supplied) to be ordered from the section orange color



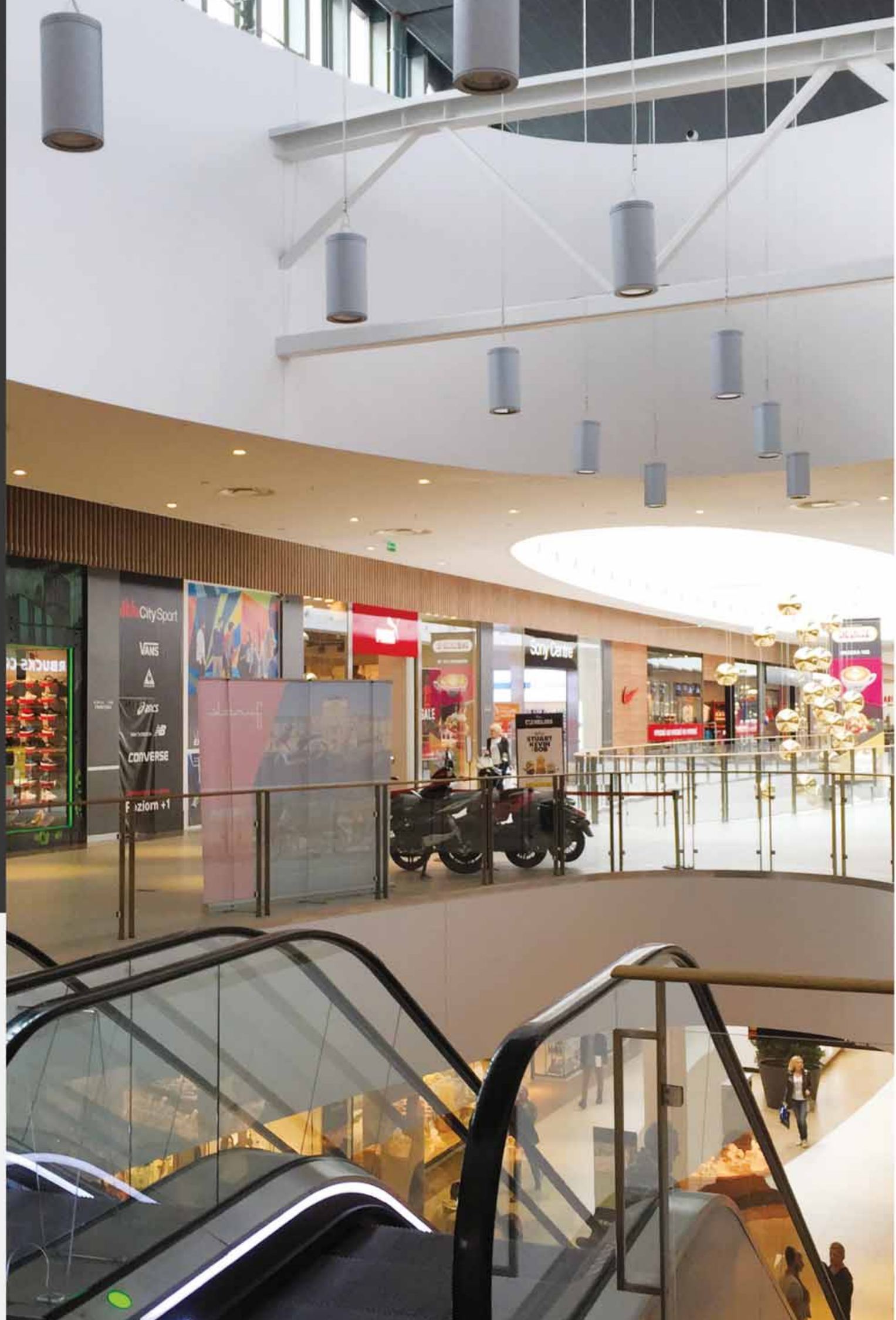



CEILING 105



- Corpo e staffa di ancoraggio in fusione di alluminio.
- Verniciatura in polveri con pre-trattamento speciale per esterni.
- Vetro di protezione temperato e viteria in acciaio inox.
- Guarnizioni in gomma siliconica.

- Body and hanging bracket in die-cast aluminium.
- Powder coating after special treatment for outdoor use.
- Tempered protection glass and stainless steel screws.
- Silicon rubber seals.

LED COB	15	24	40	LED					SYSTEM-SYSTEM				
				W	lm	V	K	CRI	W	lm	lm/W		
Br E5556C-LBC-15	E5556C-LBC-24	E5556C-LBC-40											
Ne E5557C-LBC-15	E5557C-LBC-24	E5557C-LBC-40		12,9W	1430	220-240V (350mA)	3000			12,9W	1206	81	[24°]
Gr E5558C-LBC-15	E5558C-LBC-24	E5558C-LBC-40			1310						1135	76	[36°]
Br E5556C-LBN-15	E5556C-LBN-24	E5556C-LBN-40			1120						962	65	[15°]
Ne E5557C-LBN-15	E5557C-LBN-24	E5557C-LBN-40		12,9W	1450	220-240V (350mA)	4000			12,9W	1223	82	[24°]
Gr E5558C-LBN-15	E5558C-LBN-24	E5558C-LBN-40			1430						1193	80	[36°]

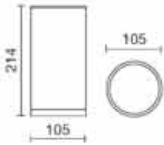

Kg
1,30

OP. **E...-LBL** = LED blu-blue
E...-600178 A richiesta - On request: versione con vetro di sicurezza a filo anello - flush glass version

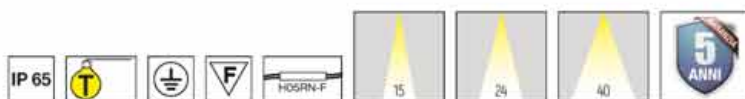

ALIMENTATORI-KIT RGB (se non in dotazione) da ordinare dalla sezione arancio - DRIVERS-RGB KITS (when not supplied) to be ordered from the section orange color





CEILING 140

- Corpo e staffa di ancoraggio in alluminio pressofuso.
- Verniciatura in polveri con pretrattamento speciale per esterni.
- Vetro di protezione temperato.
- Viteria in acciaio inox.
- Gruppo di alimentazione inserito nell'apparecchio.
- Guarnizioni e pressacavo di tenuta in gomma siliconica.

- Body and ceiling bracket in die-cast aluminium.
- Powder coated after pre-treatment for outdoor use.
- Tempered protection glass.
- Inox steel screws.
- Built-in driver.
- Silicon rubber gaskets and cable gland.



LED COB	16	24	40	LED					SISTEMA-SYSTEM			
				W	lm	V	K	°	W	lm	lm/W	
Br	E5596-LBC-16	E5596-LBC-24	E5596-LBC-40	17W	2650	220-240V [500mA]	3000	>90	20W	2175	109	[16°]
Ne	E5597-LBC-16	E5597-LBC-24	E5597-LBC-40							2082	104	[24°]
Gr	E5598-LBC-16	E5598-LBC-24	E5598-LBC-40							2121	106	[40°]
Br	E5596-LBN-16	E5596-LBN-24	E5596-LBN-40	17W	2439	220-240V [500mA]	4000	>90	20W	2002	100	[16°]
Ne	E5597-LBN-16	E5597-LBN-24	E5597-LBN-40							1916	96	[24°]
Gr	E5598-LBN-16	E5598-LBN-24	E5598-LBN-40							1952	98	[40°]

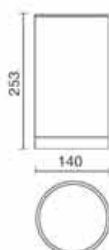

2,80
Kg

OP: **E...-600179** A richiesta - On request: versione con vetro di sicurezza a filo anello - flush glass version

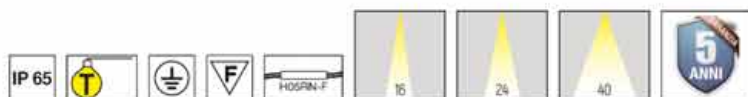

ALIMENTATORI-KIT RGB (se non in dotazione) da ordinare dalla sezione arancio - DRIVERS-RGB KITS (when not supplied) to be ordered from the section orange color

outside



CEILING 175



- Corpo e staffa di ancoraggio in alluminio pressofuso.
- Verniciatura in polveri con pretrattamento speciale per esterni.
- Vetro di protezione temperato.
- Viteria in acciaio inox.
- Gruppo di alimentazione inserito nell'apparecchio.
- Guarnizioni e pressacavo di tenuta in gomma siliconica.

- Body and ceiling bracket in die-cast aluminium.
- Powder coated after pre-treatment for outdoor use.
- Tempered protection glass.
- Inox steel screws.
- Built-in driver.
- Silicon rubber gaskets and cable gland.

LED COB	Br	Ne	Gr	15	25	40	LED				SYSTEM-SYSTEM					
							W	lm	V	K	CR	W	lm	lm/W		
	Br	E5686-LBC-16	E5686-LBC-25	E5686-LBC-40												
	Ne	E5687-LBC-16	E5687-LBC-25	E5687-LBC-40												
	Gr	E5688-LBC-16	E5688-LBC-25	E5688-LBC-40												
	Br	E5686-LBN-16	E5686-LBN-25	E5686-LBN-40												
	Ne	E5687-LBN-16	E5687-LBN-25	E5687-LBN-40												
	Gr	E5688-LBN-16	E5688-LBN-25	E5688-LBN-40												

OP. A richiesta - On request: **E...-600180** versione con vetro di sicurezza a filo anello - flush glass version
 disponibile - available

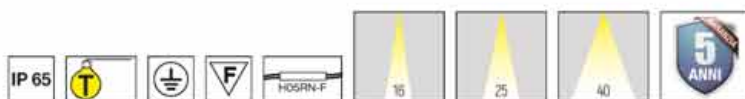

ALIMENTATORI-KIT RGB (se non in dotazione) da ordinare dalla sezione arancio - DRIVERS-RGB KITS (when not supplied) to be ordered from the section orange color







CEILING S 105



- Corpo in fusione di alluminio.
- Verniciatura in polveri con pretrattamento speciale per esterni.
- Vetro di protezione temperato.
- Viteria in acciaio inox.
- Guarnizioni e pressacavo di tenuta in gomma siliconica.
- Kit di sospensione con cavi in acciaio e cavo di alimentazione lunghezza 2 m. con rosone.

- Body made of die-cast aluminium.
- Powder coating after special treatment for outdoor use.
- Tempered protection glass.
- Stainless steel screws.
- Silicon rubber seals and cable gland.
- Complete with power cord and suspension cables 2 m. long with canopy.

	15	25	40	LED					SISTEMA-SYSTEM			
				W	lm	V	K	CRI	W	lm	lm/W	
Br	E5556C-LBC15S	E5556C-LBC24S	E5556C-LBC40S	12,9W	1040	220-240V	3000	>90	14,9W	894	60	[15°]
Ne	E5557C-LBC15S	E5557C-LBC24S	E5557C-LBC40S	14,30	1430	[350mA]			1206	81	[25°]	
Gr	E5558C-LBC15S	E5558C-LBC24S	E5558C-LBC40S	1310					1135	76	[36°]	
Br	E5556C-LBN15S	E5556C-LBN24S	E5556C-LBN40S	12,9W	1120	220-240V	4000	>90	14,9W	962	65	[15°]
Ne	E5557C-LBN15S	E5557C-LBN24S	E5557C-LBN40S	14,50	1450	[350mA]			1223	82	[25°]	
Gr	E5558C-LBN15S	E5558C-LBN24S	E5558C-LBN40S	1430					1193	80	[36°]	

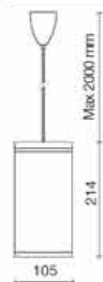

OP. **E...-LBL** = LED blu-blue
E...-600178 A richiesta - On request:
 versione con vetro di sicurezza a filo anello - flush glass version

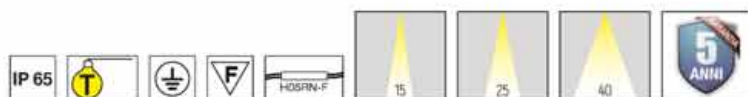

ALIMENTATORI-KIT RGB (se non in dotazione) da ordinare dalla sezione arancio - DRIVERS-RGB KITS (when not supplied) to be ordered from the section orange color





CEILING S 140

- Corpo e staffa di ancoraggio in alluminio pressofuso.
- Verniciatura in polveri con pretrattamento speciale per esterni.
- Vetro di protezione temperato.
- Viteria in acciaio inox.
- Gruppo di alimentazione inserito nell'apparecchio.
- Guarnizioni e pressacavo di tenuta in gomma siliconica.

- Body and hanging bracket in die-cast aluminium.
- Powder coated with pre-treatment for outdoor use.
- Tempered protection glass.
- Inox steel screws.
- Built-in driver.
- Silicon rubber gaskets and cable gland.



LED COB	Br	Ne	Gr	E5596-LBC-16S	E5597-LBC-16S	E5598-LBC-16S	E5596-LBC-24S	E5597-LBC-24S	E5598-LBC-24S	E5596-LBC-40S	E5597-LBC-40S	E5598-LBC-40S	LED					SISTEMA-SYSTEM									
													W	lm	V	K	°	CR	W	lm	W	°					
	Br			E5596-LBC-16S	E5597-LBC-16S	E5598-LBC-16S	E5596-LBC-24S	E5597-LBC-24S	E5598-LBC-24S	E5596-LBC-40S	E5597-LBC-40S	E5598-LBC-40S	7W	2650	220-240V (500mA)	3000	>90	20W	2175	109	16°	2082	104	24°	2121	106	40°
	Ne																										
	Gr																										
	Br			E5596-LBN-16S	E5597-LBN-16S	E5598-LBN-16S	E5596-LBN-24S	E5597-LBN-24S	E5598-LBN-24S	E5596-LBN-40S	E5597-LBN-40S	E5598-LBN-40S	7W	2439	220-240V (500mA)	4000	>90	20W	2002	100	16°	1916	96	24°	1952	98	40°
	Ne																										
	Gr																										

OP: E...-LBL = LED blu-blue

E...-600179 A richiesta - On request: versione con vetro di sicurezza a filo anello - flush glass version

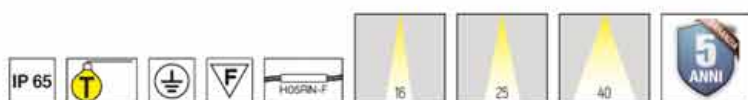

outside



- Corpo e staffa di ancoraggio in alluminio pressofuso.
- Verniciatura in polveri con pretrattamento speciale per esterni.
- Vetro di protezione temperato.
- Viteria in acciaio inox.
- Gruppo di alimentazione inserito nell'apparecchio.
- Guarnizioni e pressacavo di tenuta in gomma siliconica.

- Body and hanging bracket in die-cast aluminium.
- Powder coated with pre-treatment for outdoor use.
- Tempered protection glass.
- Inox steel screws.
- Built-in driver.
- Silicon rubber gaskets and cable gland.

CEILING S 175



LED COB	15	25	40	LED					SISTEMA-SYSTEM			
				W	lm	V	K	CRI	W	lm	lm/W	
Br E5686-LBC-16S	E5686-LBC-25S	E5686-LBC-40S		36W	4900	220-240V (1050mA)	3000	>90	40W	4446	111	[15°]
Ne E5687-LBC-16S	E5687-LBC-25S	E5687-LBC-40S	4414							110	[25°]	
Gr E5688-LBC-16S	E5688-LBC-25S	E5688-LBC-40S	4406							110	[36°]	
Br E5686-LBN-16S	E5686-LBN-25S	E5686-LBN-40S		36W	5280	220-240V (1050mA)	4000	>90	40W	4791	120	[15°]
Ne E5687-LBN-16S	E5687-LBN-25S	E5687-LBN-40S	4757							119	[25°]	
Gr E5688-LBN-16S	E5688-LBN-25S	E5688-LBN-40S	4748							119	[36°]	

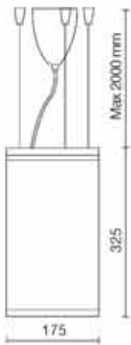

OP. E...-600180 A richiesta - On request: versione con vetro di sicurezza a filo anello - flush glass version
 disponibile - available

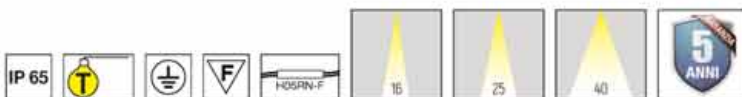

ALIMENTATORI-KIT RGB (se non in dotazione) da ordinare dalla sezione arancio - DRIVERS-RGB KITS (when not supplied) to be ordered from the section orange color



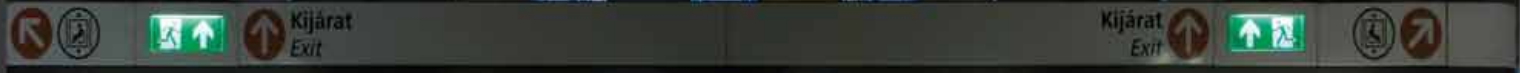

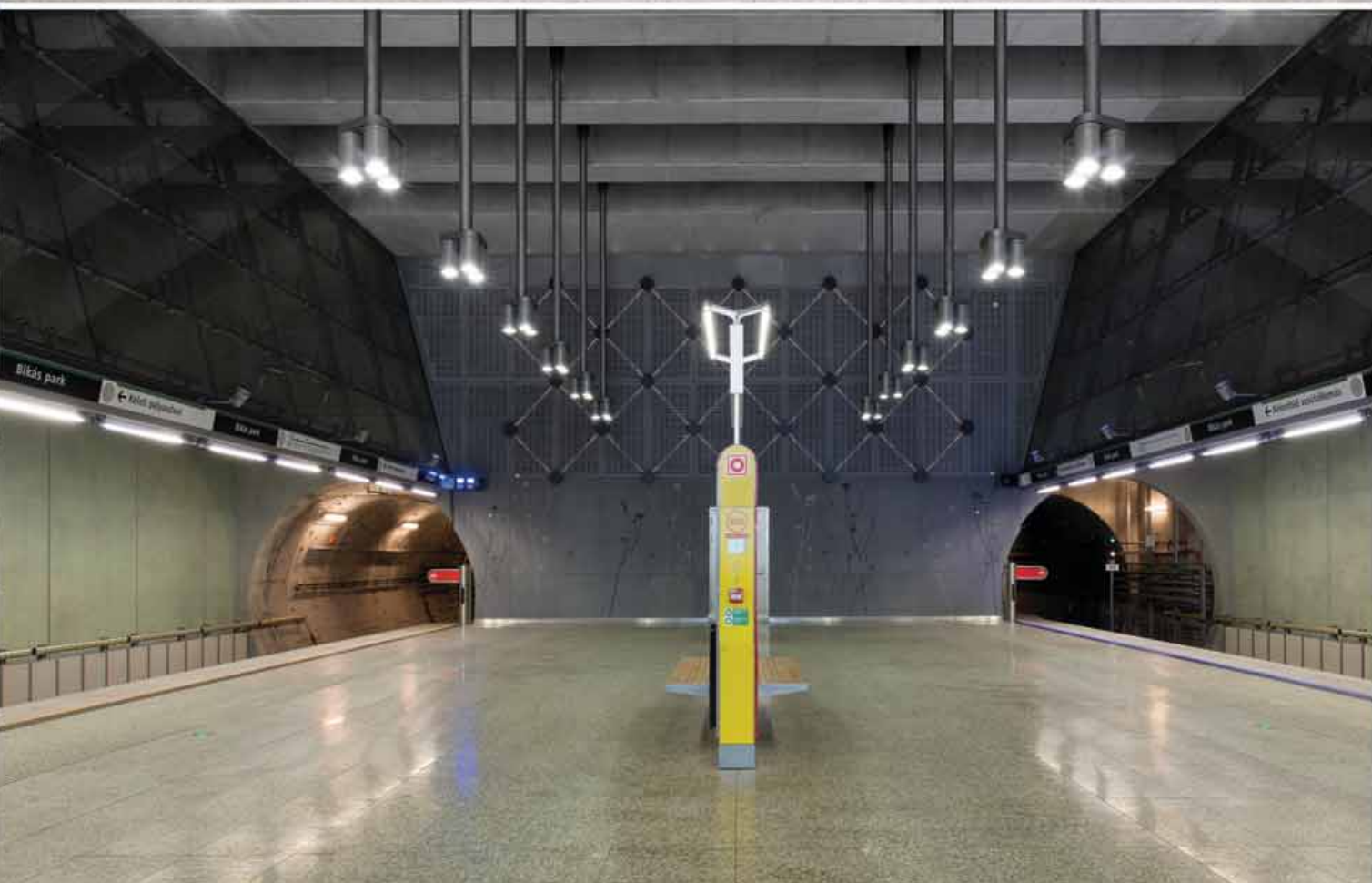
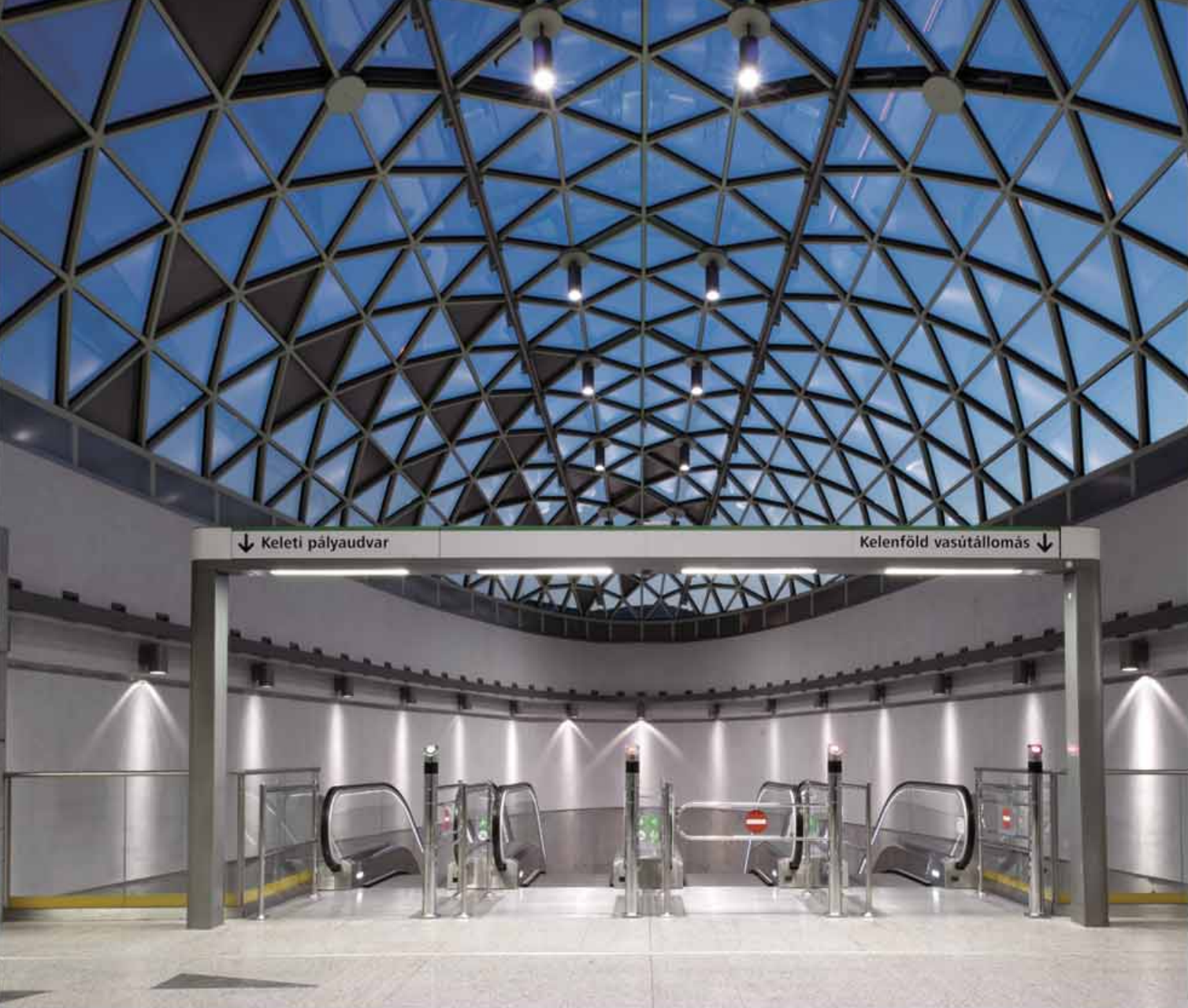



SOLARIS MINI

- Corpo in pressofusione di alluminio.
- Verniciatura in polveri epossidiche con trattamento speciale per esterni.
- Riflettore in alluminio purissimo, finitura PVD.
- Vetro di protezione chiaro serigrafato temprato.
- Guarnizioni e passacavo in gomma silconica.
- Led durata utile: 50.000 (h) L90 B20.
- Consistenza cromatica: 3 SDCM.



- Die-cast aluminium body.
- Epoxy powder coated painting after special treatment for outdoors.
- Pure aluminium reflector, PVD finish.
- Tempered clear protection glass.
- Silicon rubber gaskets and cable gland.
- Led life: 50.000 (h) L90 B20.
- Chromatic consistency: 3 SDCM.

			LED					SISTEMA-SYSTEM					
			W	lm	V	K	(CRI)	W	lm	(lm)			
PARETE ORIENTABILE - WALL ORIENTABLE	Br	67960-LBC	67966-LBC										
	Ne	67961-LBC	67967-LBC	12,4W	1510	220-240V (350mA)	3000	>90	14,4W	1121	78	SIM	
	Gr	67962-LBC	67968-LBC						1054	73	AS		
	Br	67960-LBN	67966-LBN										
	Ne	67961-LBN	67967-LBN	12,4W	1640	220-240V (350mA)	4000	>90	14,4W	1217	84	SIM	
	Gr	67962-LBN	67968-LBN						1145	80	AS		

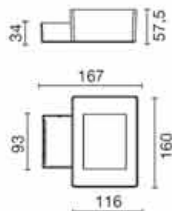

kg
2,00







- Corpo in pressofusione di alluminio.
- Verniciatura in polveri poliestere con trattamento speciale per esterni.
- Riflettore in alluminio purissimo, finitura PVD.
- Vetro di protezione chiaro serigrafato temprato.
- Guarnizioni e passacavo in gomma siliconica.
- Led durata utile: 50.000 (h) L90 B20.
- Consistenza cromatica: 3 SDCM.

- Die-cast aluminium body.
- Epoxy powder coated painting after special treatment for outdoors.
- Pure aluminium reflector, PVD finish.
- Tempered clear protection glass.
- Silicon rubber gaskets and cable gland.
- Led life: 50.000 (h) L90 B20.
- Chromatic consistency: 3 SDCM.

SOLARIS MINI FISSO

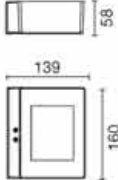

	AS	LED					SISTEMA-SYSTEM			
		W	lm	V	K	CR	W	lm	W	
PARETE FISSO - FIX WALL	  Kg 2,00	Br 67966-LBC-F	12,4W	1510	220-240V	3000	>90	14,4W	1054	73
		Ne 67967-LBC-F			[350mA]					
		Gr 67968-LBC-F								
		Br 67966-LBN-F	12,4W	1640	220-240V	4000	>90	14,4W	1145	80
		Ne 67967-LBN-F			[350mA]					
		Gr 67968-LBN-F								

OP: A richiesta - On request: versioni DALI disponibile con alimentatore remoto available version DALI with remote driver 





SOLARIS MCL

- Corpo in pressofusione di alluminio.
- Verniciatura in polveri epossidiche con trattamento speciale per esterni.
- Riflettore in alluminio purissimo, finitura PVD.
- Vetro di protezione chiaro serigrafato temprato.
- Guarnizioni e passacavo in gomma silconica.
- Led durata utile: 50.000 (h) L90 B20.
- Consistenza cromatica: 3 SDCM.

- Die-cast aluminium body.
- Epoxy powder coated painting after special treatment for outdoors.
- Pure aluminium reflector, PVD finish.
- Tempered clear protection glass.
- Silicon rubber gaskets and cable gland.
- Led life: 50.000 (h) L90 B20.
- Chromatic consistency: 3 SDCM.

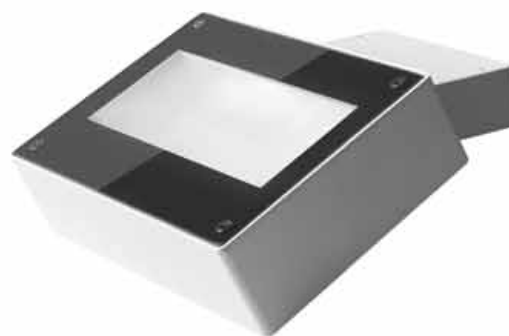

	LED	LED					SYSTEM-SYSTEM		
		W	lm	V	K	CRI	W	lm	lm
PARETE ORIENTABILE - WALL ORIENTABLE	Br 67950-LBC	40W	5540	220-240V [600mA]	3000	>90	44W	4998	114
	Ne 67951-LBC								
	Gr 67952-LBC								
PARETE ORIENTABILE - WALL ORIENTABLE	Br 67950-LBN	40W	5980	220-240V [600mA]	4000	>90	44W	5396	123
	Ne 67951-LBN								
	Gr 67952-LBN								
PARETE ORIENTABILE - WALL ORIENTABLE	Br 67950-LBC-DA	40W	5540	220-240V [600mA]	3000	>90	44W	4998	114
	Ne 67951-LBC-DA								
	Gr 67952-LBC-DA								
PARETE ORIENTABILE - WALL ORIENTABLE	Br 67950-LBN-DA	40W	5980	220-240V [600mA]	4000	>90	44W	5396	123
	Ne 67951-LBN-DA								
	Gr 67952-LBN-DA								

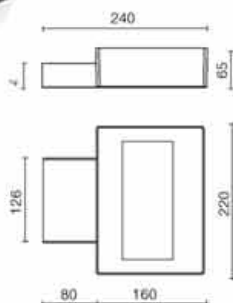

Br 67950-LBC-DA
Ne 67951-LBC-DA
Gr 67952-LBC-DA

Br 67950-LBN-DA
Ne 67951-LBN-DA
Gr 67952-LBN-DA

QR

A richiesta - On request: classe - class
disponibile - available DIM 1+ 10V

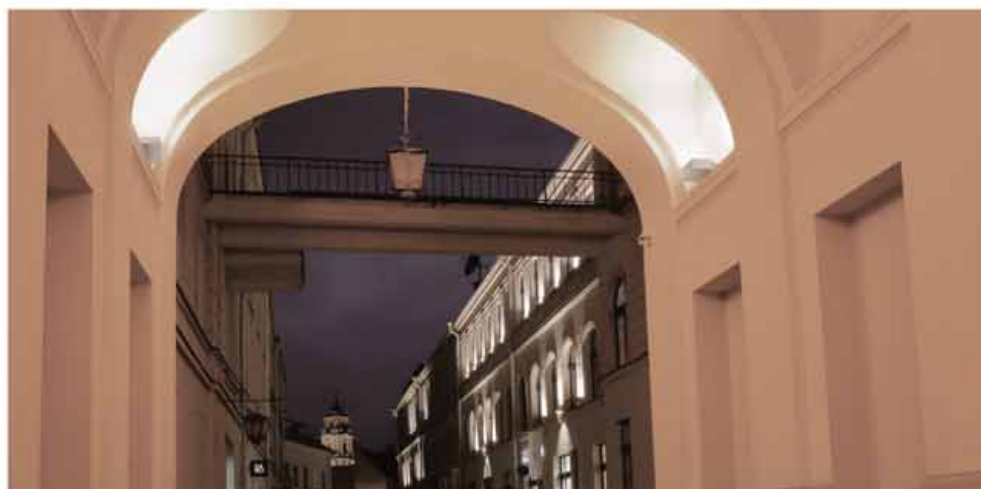
IP65
IK06

inside outside

C180 C00 | C270 — C90

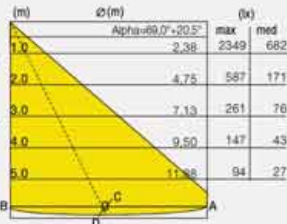
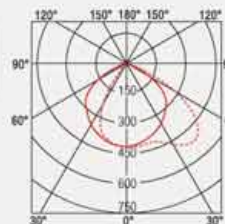
40W
...LBC
AS

ALIMENTATORI-KIT RGB (se non in dotazione) da ordinare dalla sezione arancio - DRIVERS-RGB KITS (when not supplied) to be ordered from the section orange color



SOLARIS MCL FISSO



- Corpo in pressofusione di alluminio.
 - Verniciatura in polveri poliestere con trattamento speciale per esterni.
 - Riflettore in alluminio purissimo, finitura PVD.
 - Vetro di protezione chiaro serigrafato temprato.
 - Guarnizioni e passacavo in gomma siliconica.
 - Led durata utile: 50.000 (h) L90 B20.
 - Consistenza cromatica: 3 SDCM.
- Die-cast aluminium body.
 - Epoxy powder coated painting after special treatment for outdoors.
 - Pure aluminium reflector, PVD finish.
 - Tempered clear protection glass.
 - Silicon rubber gaskets and cable gland.
 - Led life: 50.000 (h) L90 B20.
 - Chromatic consistency: 3 SDCM.

	AS	LED					SISTEMA-SYSTEM		
		W	lm	V	K	CRI	W	lm	lm/W
PARETE FISSO - FIX WALL	Br 67950-LBC-F	40W	5540	220-240V (600mA)	3000	>90	44W	4898	114
	Ne 67951-LBC-F								
	Gr 67952-LBC-F								
	Br 67950-LBN-F	40W	5980	220-240V (600mA)	4000	>90	44W	5396	123
	Ne 67951-LBN-F								
	Gr 67952-LBN-F								
	Br 67950-LBC-DA-F	40W	5540	220-240V (600mA)	3000	>90	44W	4898	114
	Ne 67951-LBC-DA-F								
	Gr 67952-LBC-DA-F								
	Br 67950-LBN-DA-F	40W	5980	220-240V (600mA)	4000	>90	44W	5396	123
	Ne 67951-LBN-DA-F								
	Gr 67952-LBN-DA-F								

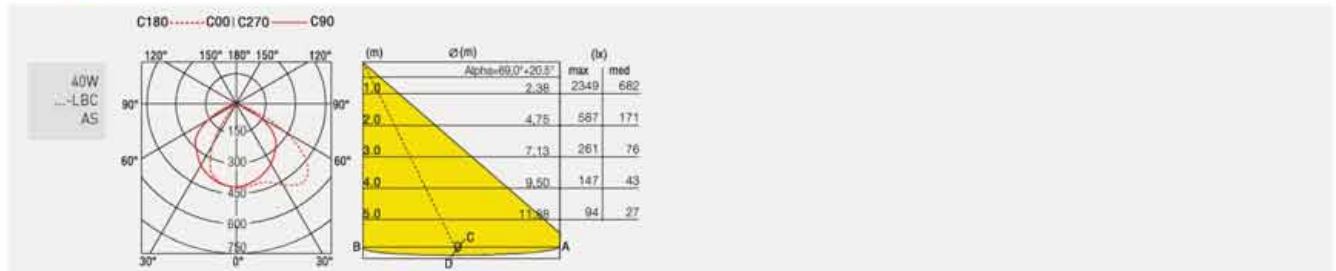

ALIMENTATORI-KIT RGB (se non in dotazione) da ordinare dalla sezione arancio - DRIVERS-RGB KITS (when not supplied) to be ordered from the section orange color





PROIETTORI DIFFONDENTI - LINEARI - SPOT FLOODLIGHTING - LINEAR - SPOT PROJECTORS

outside

• DIFFONDENTI - FLOODLIGHTING



AZIMUTH

559



DUNE

561



SD-HIGHBAY

563

• LINEARI - LINEAR



MINI LONGLIGHT
ST

564



LONGLIGHT
ST

565



LONGLIGHT
WALL

567



LONGLIGHT
ECO ST

568



LONGLIGHT
ECO WALL

569



NEW ACTIVA

571



FIN

573



MICRO LEDLINE
TONDO

575



MINI LEDLINE
TONDO

577

• SPOT



SPOT 4

579



SPOT 7

581



SPOT MCL

581

NEW



SPOT

583



MICRO REEF

589



MINI REEF

591



REEF

593





AZIMUTH



- Proiettore in pressofusione di alluminio.
- Vetro di protezione extrachiari temperato.
- Orientamento corpo proiettore 30÷150°.
- Cavo di alimentazione lunghezza 0,3 m.

- Spot made of die-cast aluminium.
- Extra clear tempered glass.
- Swivelling body 30÷150°.
- Power cable length 0,3 m.

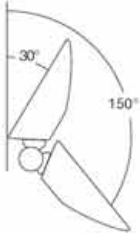

	LED	SISTEMA-SYSTEM		
		W	lm	lm/W
Br E1124-LBC Ne E1125-LBC Gr E1126-LBC	34W 3060 220-240V [650mA]	3000	>90	38W 2473 65
Br E1124-LBI Ne E1125-LBI Gr E1126-LBI	34W 3760 220-240V [650mA]	4000	>90	38W 3039 80

ALIMENTATORI CONSIGLIATI - RECOMMENDED DRIVERS				
645846	ON-OFF	27-50W	IP20	350-1050mA

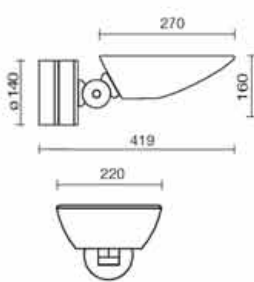

	LED	SISTEMA-SYSTEM		
		W	lm	lm/W
Br E1118-LBC Ne E1119-LBC Gr E1120-LBC	34W 3060 650mA	3000	>90	
Br E1118-LBI Ne E1119-LBI Gr E1120-LBI	34W 3760 650mA	4000	>90	
Br E1118-RGB Ne E1119-RGB Gr E1120-RGB	14W 624 350mA			

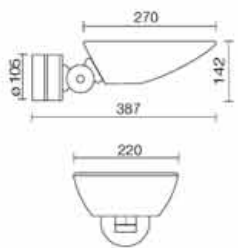

OP. *A richiesta: apertura fascio - On request: light beam 25 50 65

ACC. Per versione RGB - For RGB version
 645247 Alimentatore-Miscelatore - Driver-Mixer
 645246 Controller IR - IR controller
 645245 Telecomando - Remote

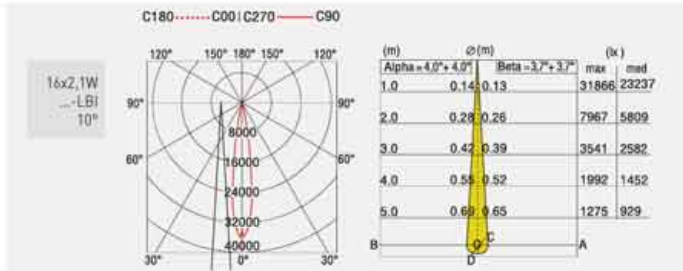

ALIMENTATORI-KIT RGB (se non in dotazione) da ordinare dalla sezione arancio - DRIVERS-RGB KITS (when not supplied) to be ordered from the section orange color



IP 65

outside

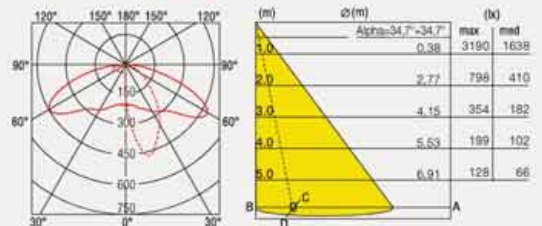
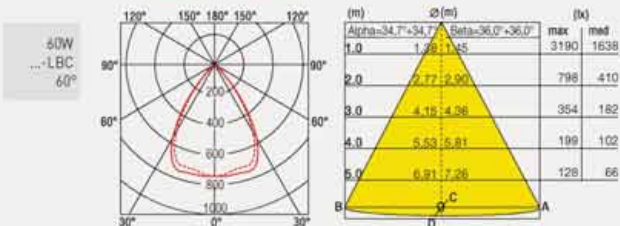
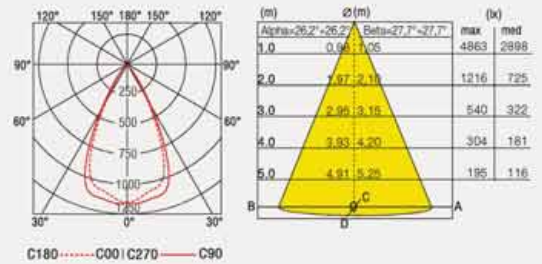
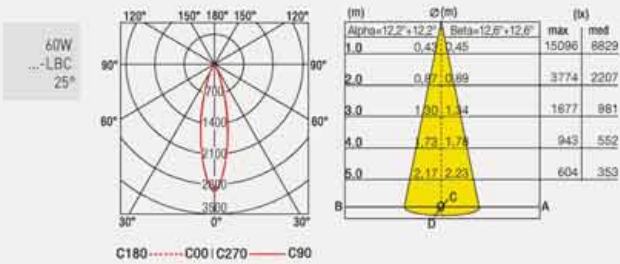

ALIMENTATORI-KIT RGB (se non in dotazione) da ordinare dalla sezione arancio - DRIVERS-RGB KITS (when not supplied) to be ordered from the section orange color



- Corpo e cornice in pressofusione di alluminio.
- Vernice in polveri con pretrattamento speciale per esterni.
- Vetro di protezione.
- Riflettore in alluminio purissimo.

- Die-cast aluminium housing and frame.
- Powder coated after special treatment for outdoor use.
- Protection glass.
- Reflector of very pure aluminium.

	E4010-LBC E4010-LBN	E4011-LBC E4011-LBN	LED				SYSTEM-SYSTEM			
			W	lm	V	K	CRI	W	lm	lm/W
	60W	5010 6180	220-240V [700mA]	3000 4000	>90	64W	4230 5223	66 81	[25°] [65°]	



DP: * A richiesta - On request: lenti per fascio asimmetrico - lenses for asymmetric beam

ACC.	Kit sostituzione sorgente tradizionale con modulo Led - Traditional source replacement with Led module kit			
Ne 699938-LBC	699942-LBC	Kit Led	50W	3000K
Ne 699938-LBN	699942-LBN	Kit Led	50W	4000K

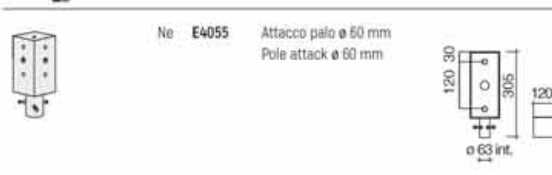
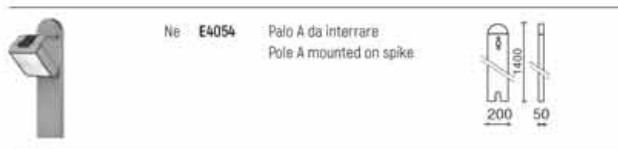
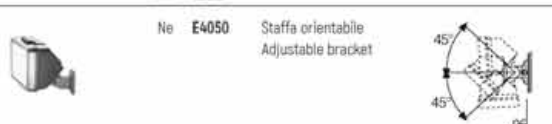
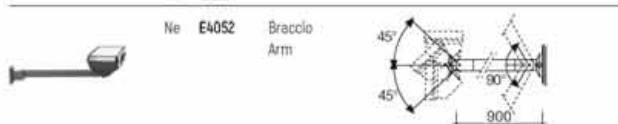



IP 65 IK 08 T 850° C 2m RG0 50 80 5 ANNI

outside

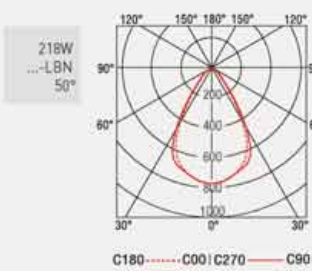

(m)	∅ (m)	(lx)
		max med
1.0	1.14 1.26	25246 13624
2.0	2.27 2.53	6311 3406
3.0	3.56 3.79	2805 1514
4.0	4.74 5.05	1578 852
5.0	5.93 6.32	1010 545

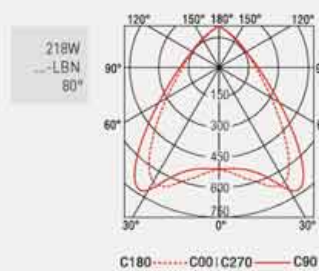

(m)	∅ (m)	(lx)
		max med
1.0	1.47 1.65	8996 8996
2.0	2.98 3.32	2249 2249
3.0	4.46 4.98	1000 1000
4.0	5.95 6.64	562 562
5.0	7.44 8.30	360 360

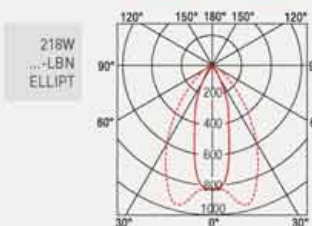

(m)	∅ (m)	(lx)
		max med
1.0	1.39 1.49	28439 18003
2.0	2.71 2.98	7110 4501
3.0	4.07 4.48	3160 2000
4.0	5.42 5.97	1777 1125
5.0	6.78 7.46	1138 720

ALIMENTATORI-KIT RGB (se non in dotazione) da ordinare dalla sezione arancio - DRIVERS-RGB KITS (when not supplied) to be ordered from the section orange color

SD-HIGHBAY



- Corpo in alluminio pressofuso con alette dissipanti integrate.
- Verniciatura con polveri di poliestere con trattamento speciale per esterni.
- Riflettore in alluminio purissimo.
- Vetro di protezione spessore 4 mm temperato extrachiaro.
- Connettore stagno IP68 presa/spina ad innesto rapido.
- Dispositivo di protezione sovratensioni 10 KV.
- Ta -25+40°C.
- Led durata utile: 85.000 (h) L80 B10.
- Consistenza cromatica: 2 SDCM.
- Fattore di potenza > 0,95.
- Lumen tipici aTp. 65°, Temperatura rilevata Tp 62°C.
- Utilizzabile con linee di emergenza ad alimentazione centralizzata.

- Die-cast aluminum body with integrated dissipating fins.
- Painting with polyester powders with special treatment for outdoor use.
- Reflector in pure aluminum.
- Clear tempered glass diffuser 4mm thick.
- IP68 quick plug and socket.
- 10 KV surge protection device (SPD).
- Working temperature: -25 +40°C.
- Led life: 85.000 (h) L80 B10.
- Chromatic consistency: 2 SDCM.
- Power factor > 0.95.
- Lumen typical values aTp. 65°, Temperature detected Tp 62°C.
- Usable with emergency lines with centralized power-supply.

	50	80	E	LED					SYSTEM-SYSTEM			
				W	lm	V	K	CRI	W	lm	lm	
SOSPENSIONE - SUSPENSION												
	GrA	E6000-LBN	E6005-LBN	E6010-LBN	218W	32640	220-240V [1050mA]	4000	>90	234W*	28530*	122
	GrA	E6001-LBN	E6006-LBN	E6011-LBN	148W	21720	220-240V [1050mA]	4000	>90	164W*	18219*	111
	GrA	E6003-LBN	E6007-LBN	E6009-LBN	82W	13560	220-240V [600mA]	4000	>90	92W*	11374*	124
DALI DIM-DALI/PUSH												
	GrA	E6000-LBN-DA	E6005-LBN-DA	E6010-LBN-DA	218W	32640	220-240V [1050mA]	4000	>90	234W*	28530*	122
	GrA	E6001-LBN-DA	E6006-LBN-DA	E6011-LBN-DA	148W	21720	220-240V [1050mA]	4000	>90	164W*	18219*	111
	GrA	E6003-LBN-DA	E6007-LBN-DA	E6009-LBN-DA	82W	13560	220-240V [600mA]	4000	>90	92W*	11374*	124
PARETE/PLAFONE - WALL/CEILING												
	GrA	E6000-LBN-P	E6005-LBN-P	E6010-LBN-P	218W	32640	220-240V [1050mA]	4000	>90	234W*	28530*	122
	GrA	E6001-LBN-P	E6006-LBN-P	E6011-LBN-P	148W	21720	220-240V [1050mA]	4000	>90	164W*	18219*	111
	GrA	E6003-LBN-P	E6007-LBN-P	E6009-LBN-P	82W	13560	220-240V [600mA]	4000	>90	92W*	11374*	124
DALI DIM-DALI/PUSH												
	GrA	E6000LBN-DA-P	E6005LBN-DA-P	E6010LBN-DA-P	218W	32640	220-240V [1050mA]	4000	>90	234W*	28530*	122
	GrA	E6001LBN-DA-P	E6006LBN-DA-P	E6011LBN-DA-P	148W	21720	220-240V [1050mA]	4000	>90	164W*	18219*	111
	GrA	E6003LBN-DA-P	E6007LBN-DA-P	E6009LBN-DA-P	82W	13560	220-240V [600mA]	4000	>90	92W*	11374*	124

OP. A richiesta - On request: griglia di protezione - protection grid

ACC. E6002 Paraluce - Lens hood

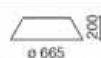

*Valori riferiti agli apparecchi con fascio luminoso da 80° - Value for fittings with beam angle 80°

MINI LONGLIGHT ST

- Corpo in estruso di alluminio anodizzato.
- Vano ottico: recuperatore di flusso in alluminio satinato.
- Vetro di protezione trasparente spessore 6 mm
- Pressacavo in ottone nichelato PG7.
- Cavo di alimentazione lunghezza 1 m.

- Body made of anodized aluminium extrusion.
- Optic: satin aluminium reflector.
- Transparent tempered glass protection thickness 6 mm.
- Cable gland of nickel plated brass PG7.
- Power cable length 1 m.



VS Vetro sabbato - Frosted Glass
 VT Vetro trasparente - Transparent Glass

	LED	LED					SISTEMA-SYSTEM						
		W	lm	V	K	CRI	T	W	lm	lm/W			
	0.23 kg T VT Inox	E9054-P-LBC		3,1W	300	220-240V	3000	>90	45°	4,5W	210	47	
		E9054-P-LBN		330	[350mA]	4000					230	51	
IP 20 Alimentatore remoto in dotazione Remote driver supplied IP 67 A richiesta codice 645311-67 On request code 645311-67													
VERSIONE CORTA - SHORT VERSION													
	1.00 kg T VS	E9051-P-LBC		tot. 1,5W	64	220-240V	3000	>70	30°	2,5W	51	20	
		E9051-P-LBN		78 LED SMD	65	12Vdc	4000				52	21	
	1.00 kg T VT	E9050-P-LBC		tot. 7W	550	220-240V	3000	>90	45°	8W	333	42	
		E9050-P-LBN		600	[350mA]	4000					363	45	
IP 20 Alimentatore remoto in dotazione Remote driver supplied IP 67 A richiesta codice 645311-67 On request code 645311-67													
	T VT	E9052-P-LBC		11,2W	1360	220-240V	3000	>90		13,2W	1001	76	
		E9052-P-LBN		1450	24Vdc	4000					1033	81	
VS Incox E9051-P-RGB tot. 3,5W 75 LED SMD 													
VERSIONE LUNGA - LONG VERSION													
	1.80 kg T VS	E9061-P-LBC		tot. 3W	128	220-240V	3000	>70	35°	4W	102	25	
		E9061-P-LBN		36 LED SMD	130	12Vdc	4000				104	26	
	1.80 kg T VT	E9060-P-LBC		tot. 14W	1100	220-240V	3000	>90	45°	16W	666	42	
		E9060-P-LBN		1200	[350mA]	4000					726	45	
IP 20 Alimentatore remoto in dotazione Remote driver supplied IP 67 A richiesta codice 645367 On request code 645367													
	T VT	E9062-P-LBC		22,4W	2720	220-240V	3000	>90		25,4W	2022	80	
		E9062-P-LBN		2900	24Vdc	4000					2156	85	
VS Incox E9061-P-RGB tot. 7W 30 LED SMD 													

OP. A richiesta - On request: staffe fisse per fissaggio a parete - fixed brackets for wall fixing

*Solo apparecchio - Only fitting



outside

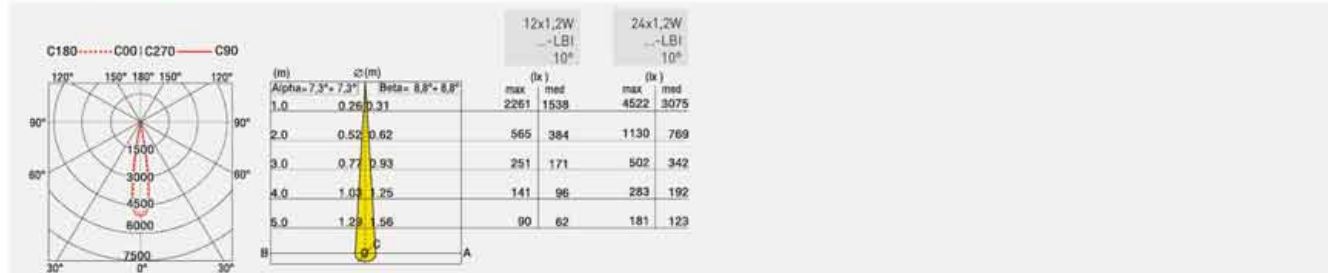

ALIMENTATORI-KIT RGB (se non in dotazione) da ordinare dalla sezione arancio - DRIVERS-RGB KITS (when not supplied) to be ordered from the section orange color



- Corpo in alluminio estruso con verniciatura previo trattamento speciale per esterni.
- Guarnizioni in gomma silconica.
- Testate in alluminio pressofuso fosfocromatate e verniciate.
- Vetro temperato trasparente di spessore 8 mm.
- Pressacavo PG9.
- Installazione e cablaggio senza apertura del vano ottico.
- Cavo di alimentazione lunghezza 1 m.

- Housing of aluminium extrusion painted after previous special pre-treatment for outdoor use.
- Silicon rubber gasket.
- End caps of die-cast aluminium, painted with phosphorchrome treatment
- Transparent tempered glass thickness 8 mm.
- PG9 cable gland.
- Installation and connection without openin.
- Power cable length 1 m.



L (mm)	LED	W	lm	V	K	CRI	T	SISTEMA-SYSTEM		
								W	lm	lm/W
399	Alis E8900-PS-LBC	tot. 1,5W	64	220-240V	3000	>70	32°	2,5W	46	18
	E8900-PS-LBN	18 LED SMD	65	12Vdc	4000	>70	32°			
399	Alis E8910-PS-LBC	tot. 3W	128	220-240V	3000	>70	35°	4W	92	23
	E8910-PS-LBN	36 LED SMD	129	12Vdc	4000	>70	35°			
960	Alis E8920-PS-LBC	tot. 4W	173	220-240V	3000	>70	38°	5W	125	25
	E8920-PS-LBN	48 LED SMD	176	12Vdc	4000	>70	38°			
960	Alis E8930-PS-LBC	tot. 8W	341	220-240V	3000	>70	42°	9W	246	27
	E8930-PS-LBN	96 LED SMD	346	12Vdc	4000	>70	42°			
399	Alis E8941-PS-LBC	12x1,2W	970	220-240V	3000	>90	38°	16W	873	54
	E8941-PS-LBN	1050	24Vdc	4000	>90	38°				
960	Alis E8951-PS-LBC	36x1,2W	2900	220-240V	3000	>90	42°	46W	2360	51
	E8951-PS-LBN	3150	24Vdc	4000	>90	42°				
1280	Alis E8957-PS-LBC	48x1,2W	3880	220-240V	3000	>90	42°	60W	3490	58
	E8957-PS-LBN	4200	24Vdc	4000	>90	42°				
1560	Alis E8958-PS-LBC	60x1,2W	4800	220-240V	3000	>90	42°	74W	4365	59
	E8958-PS-LBN	5250	24Vdc	4000	>90	42°				

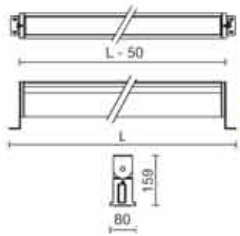

OP. A richiesta - On request: staffe fisse per fissaggio a parete - fixed brackets for wall fixing
apertura fascio - light beam

ACC. 646308 Connettore IP68 Ø da 7 a 12mm - IP68 connector Ø from 7 to 12mm

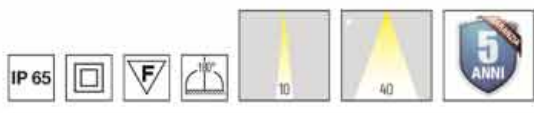

ALIMENTATORI-KIT RGB (se non in dotazione) da ordinare dalla sezione arancio - DRIVERS-RGB KITS (when not supplied) to be ordered from the section orange color





LONGLIGHT WALL

- Corpo in alluminio estruso con verniciatura per esterni previo trattamento di fosfocromatazione.
- Guarnizioni in gomma silicónica.
- Testate in alluminio pressofuso fosfocromatate e verniciate.
- Vetro temperato trasparente di spessore 8 mm.
- Installazione senza apertura del vano ottico.
- Possibilità di installazione a soffitto o parete.
- Cavo di alimentazione lunghezza 1 m.



- Extruded aluminium body with painting for outdoor, phosphochromated.
- Silicone gum gasket.
- Die-castend pieces aluminium painted and phosphochromated
- Transparent tempered glass thickness 8 mm.
- Installation and wiring without opening the seales optic.
- Possibility to be installed in the wall or in the ceiling.
- Power cable length 1 m.

L (mm)	LED							SYSTEM-SYSTEM			
	W	lm	V	K	CRI	T	W	lm	lm/W		
380	E8900-P-LBC		tot. 1,5W	64	220-240V	3000	>70	32°	2,5W	46	18
	E8900-P-LBN		18 LED SMD	65	12Vdc	4000			47	19	
380	E8910-P-LBC		tot. 3W	128	220-240V	3000	>70	35°	4W	92	23
	E8910-P-LBN		36 LED SMD	129	12Vdc	4000			93	23	
940	E8920-P-LBC		tot. 4W	173	220-240V	3000	>70	38°	5W	125	25
	E8920-P-LBN		48 LED SMD	176	12Vdc	4000			127	26	
940	E8930-P-LBC		tot. 8W	341	220-240V	3000	>70	42°	9W	246	27
	E8930-P-LBN		96 LED SMD	346	12Vdc	4000			253	28	
380	E8941-P-LBC		12x1,2W	970	220-240V	3000	>90	38°	16W	873	54
	E8941-P-LBN		1050	1050	24Vdc	4000			945	59	
940	E8951-P-LBC		36x1,2W	2900	220-240V	3000	>90	42°	46W	2360	51
	E8951-P-LBN		3150	3150	24Vdc	4000			2550	55	
1240	E8957-P-LBC		48x1,2W	3880	220-240V	3000	>90	42°	60W	3490	58
	E8957-P-LBN		4200	4200	24Vdc	4000			3780	63	
1540	E8958-P-LBC		60x1,2W	4800	220-240V	3000	>90	42°	74W	4364	59
	E8958-P-LBN		5250	5250	24Vdc	4000			4725	64	

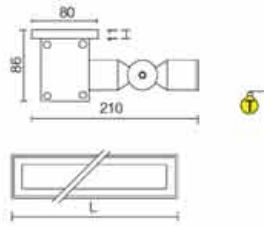

OP. *A richiesta - On request: apertura fascio - light beam

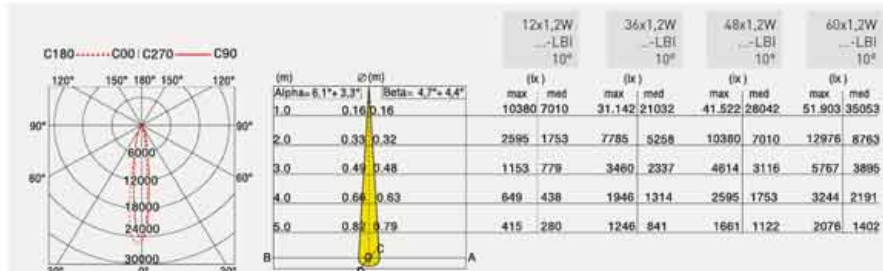
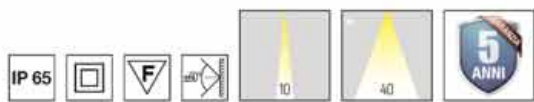

ALIMENTATORI-KIT RGB (se non in dotazione) da ordinare dalla sezione arancio - DRIVERS-RGB KITS (when not supplied) to be ordered from the section orange color

LONGLIGHT ECO ST



- Corpo in alluminio estruso con verniciatura previo trattamento speciale per esterni.
- Guarnizioni in gomma silconica.
- Testate in alluminio pressofuso fosfocromatate e verniciate.
- Vetro temperato trasparente di spessore 8 mm.
- Pressacavo PG9.
- Installazione e cablaggio senza apertura del vano ottico.
- Cavo di alimentazione lunghezza 1 m.

- Housing of aluminium extrusion painted after pre-treatment for outdoor use.
- Silicon rubber gasket.
- Die-cast aluminium end caps, painted with phosphorochrome treatment.
- Transparent tempered glass thickness 8 mm.
- PG9 cable gland.
- Installation and connection without opening the sealed optic.
- Power cable length 1 m.



	L (mm)	LED					SYSTEM-SYSTEM		
		W	lm	V	K	CRI	W	lm	lm/w
 1.80 Alu E8941-PS-LBC6 E8941-PS-LBN6	399	6x1,2W	480 520	220-240V [350mA]	3000 4000	>90	8W	438 472	55 59
	 4.30 Alu E8951PS-LBC18 E8951PS-LBN18	960	18x1,2W	1440 1560	220-240V [350mA]	3000 4000	>90	24W	1315 1420
 5.60 Alu E8957PS-LBC24 E8957PS-LBN24		1260	24x1,2W	1920 2080	220-240V [350mA]	3000 4000	>90	32W	1750 1890
	 7.00 Alu E8958PS-LBC30 E8958PS-LBN30	1560	30x1,2W	2400 2600	220-240V [350mA]	3000 4000	>90	39W	2186 2362

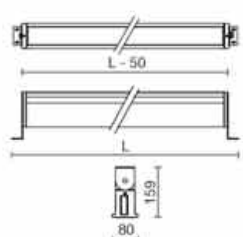

OP. *A richiesta - On request: apertura fascio - light beam disponibile - available



ACC. 646308 Connettore IP68 Ø da 7 a 12mm - IP68 connector Ø from 7 to 12mm



outside

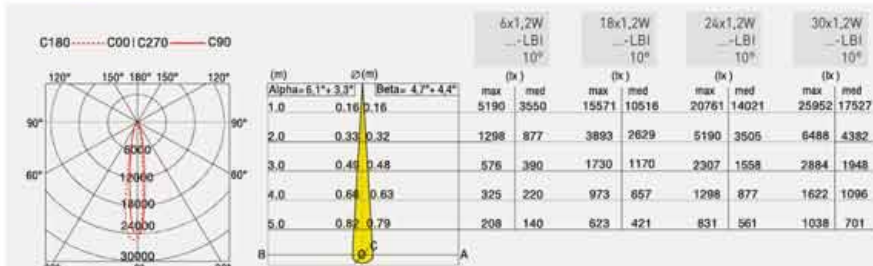

ALIMENTATORI-KIT RGB (se non in dotazione) da ordinare dalla sezione arancio - DRIVERS-RGB KITS (when not supplied) to be ordered from the section orange color



LONGLIGHT ECO WALL



- Corpo in alluminio estruso con verniciatura per esterni previo trattamento di fosfocromatazione.
 - Guarnizioni in gomma siliconica.
 - Testate in alluminio pressofuso fosfocromatate e verniciate.
 - Vetro temperato trasparente di spessore 8 mm.
 - Installazione senza apertura del vano ottico.
 - Possibilità di installazione a soffitto o parete.
 - Cavo di alimentazione lunghezza 1 m.
- Body in extruded aluminium after painting for outdoor, phosphochromated.
 - Silicone rubber gasket.
 - Die-cast aluminium end pieces painted and phosphochromated.
 - Transparent tempered glass thickness 8 mm.
 - Installation and wiring without opening the sealed optic.
 - Suitable for wall and ceiling installation.
 - Power cable length 1 m.

	L (mm)	LED					SISTEMA/SYSTEM		
		W	lm	V	K	CRI	W	lm	lm/W
	380	6x1,2W	480	220-240V (350mA)	3000	>90	8W	438	55
	Alt: E8941-P-LBC-6 E8941-P-LBN-6	520	4000			472	59		
	940	18x1,2W	1440	220-240V (350mA)	3000	>90	24W	1315	55
	Alt: E8951-P-LBC18 E8951-P-LBN18	1560	4000			1420	59		
	1240	24x1,2W	1920	220-240V (350mA)	3000	>90	32W	1750	55
	Alt: E8957-P-LBC24 E8957-P-LBN24	2080	4000			1890	59		
	1540	30x1,2W	2400	220-240V (350mA)	3000	>90	39W	2186	56
	Alt: E8958-P-LBC30 E8958-P-LBN30	2600	4000			2362	60		

OP. *A richiesta - On request: apertura fascio - light beam disponibile - available

ACC. **646308** Connettore IP68 Ø da 7 a 12mm - IP68 connector Ø from 7 to 12mm

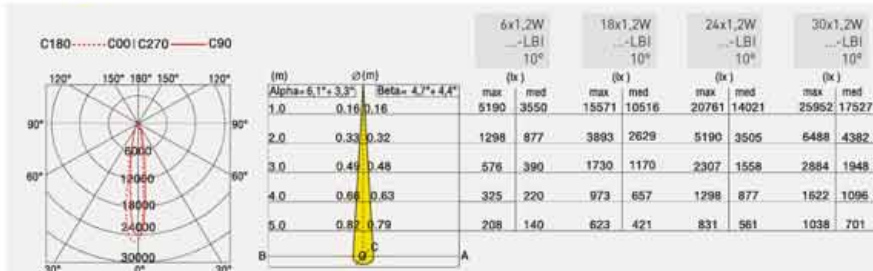

ALIMENTATORI-KIT RGB (se non in dotazione) da ordinare dalla sezione arancio - DRIVERS-RGB KITS (when not supplied) to be ordered from the section orange color



théâtres
parisiens
associés

THÉÂTRE MICHEL

MÊME SI TU M'AIMES

MISE EN SCÈNE
JULIEN BOISSELIER

ASSISTANTE À LA MISE EN SCÈNE
FABIENNE TOURNET

COMPOSITEUR MUSIQUE
JEAN-MICHEL BERNARD

CRÉATION LUMIÈRES
JEAN-PIERRE BOUVIER

DE
**MÉLISSA DRIGEARD
& VINCENT JUILLET**

AVEC
**PIERRE AZÉMA
MÉLISSA DRIGEARD
MORGAN PEREZ**

«Intelligent, drôle
et sensible» **Télérama (TT)**



«Juste magnifique.
Allez-y les yeux fermés !»
France Bleu

Représentations du mardi au samedi à 21h00,
matinées le samedi à 16h30 et le dimanche à 15h00

LOCATION 01 42 65 35 02 - www.theatre-michel.fr
100 rue Mathurins 75008 Paris - Métro Havre-Caumartin
01 42 68 35 62 (0.34 €/minute) - www.fnac.com



Conception et illustration : Paella, Nargis, HÉLÈNE 10 24 734



- Corpo in alluminio estruso.
- Staffe di fissaggio a muro regolabile.
- Cavo di alimentazione incluso da 1 m.
- Schermo in protezione in vetro extrachiario temperato.
- Viti in acciaio inox.

- Extruded aluminium body.
- Adjustable fixing brackets.
- Supplied with 1 m. cable.
- Extra transparent tempered glass.
- Inox screws.



	L [mm]	LED					SYSTEM-SYSTEM			
		W	lm	V	K	CRI	T	W	lm	W
	606	24x1,2W	2100	220-240V 24Vcc	6000	>90	38°	32W	1700	53
	936	36x1,2W	3130				42°	40W	2550	56
	1206	48x1,2W	4200				42°	60W	3780	63
	1506	60x1,2W	5250				42°	74W	4725	64

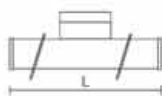

OP. A richiesta - On request: versioni ...-LBC

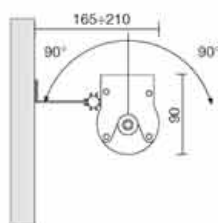
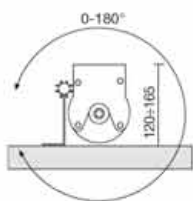

outside

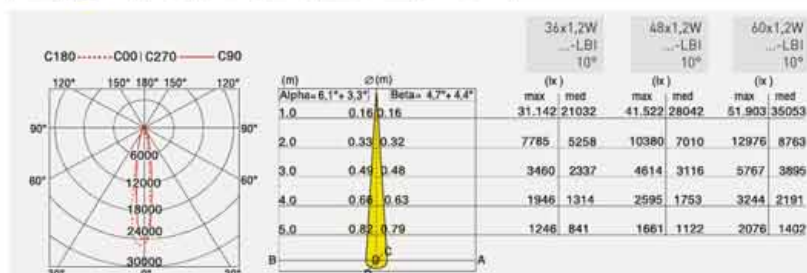

ALIMENTATORI-KIT RGB (se non in dotazione) da ordinare dalla sezione arancio - DRIVERS-RGB KITS (when not supplied) to be ordered from the section orange color





FIN

- Corpo in estruso di alluminio anodizzato.
- Lenti in metacrilato.
- Pressacavo ottone nichelato PG7.
- Cavo di alimentazione lunghezza 1 m.
- Driver in dotazione.

- Body made of extruded anodized aluminum
- Methacrylate lenses.
- Cable gland of nickel plated brass PG7.
- Power cable length 1 m.
- Driver supplied.



	Icone	LED					SISTEMA-SYSTEM							
		W	lm	V	K	CRI	W	lm	lm					
		Als. E9030-LBC-25	E9030-LBC-35	E9030-LBC-EL	-	8,5W	800	220-240V	5000	>90	9,5W	704	74	[25°]
		E9030-LBN-25	E9030-LBN-35	E9030-LBN-EL		950	950	[500mA]	4000		836	88	[35°]	
		Als. E9031-LBC-25	E9031-LBC-35	E9031-LBC-EL	con PALPEBBRA	8,5W	800	220-240V	5000	>90	9,5W	552	58	[25°]
		E9031-LBN-25	E9031-LBN-35	E9031-LBN-EL	with EYELID	950	950	[500mA]	4000		656	69	[35°]	

		Als. E9032-LBC-25	E9032-LBC-35	E9032-LBC-EL	-	17W	1600	220-240V	3000	>90	20W	1408	70	[25°]
		E9032-LBN-25	E9032-LBN-35	E9032-LBN-EL		1900	1900	[500mA]	4000		1672	84	[35°]	
		Als. E9033-LBC-25	E9033-LBC-35	E9033-LBC-EL	con PALPEBBRA	17W	1600	220-240V	3000	>90	20W	1104	55	[25°]
		E9033-LBN-25	E9033-LBN-35	E9033-LBN-EL	with EYELID	1900	1900	[500mA]	4000		1311	66	[35°]	

		Als. E9034-LBC-25	E9034-LBC-35	E9034-LBC-EL	-	25,5W	2400	220-240V	3000	>90	29,5W	2112	72	[25°]
		E9034-LBN-25	E9034-LBN-35	E9034-LBN-EL		2850	2850	[500mA]	4000		2508	85	[35°]	
		Als. E9035-LBC-25	E9035-LBC-35	E9035-LBC-EL	con PALPEBBRA	25,5W	2400	220-240V	3000	>90	29,5W	1656	56	[25°]
		E9035-LBN-25	E9035-LBN-35	E9035-LBN-EL	with EYELID	2850	2850	[500mA]	4000		1967	67	[35°]	

OP. Maggiori lunghezze a richiesta - Longer lengths on request



Kit di fissaggio n. 2 pezzi - Fixing kit n. 2 pieces

- 161 h 46 mm
- 162 h 90 mm
- 163 h 156 mm

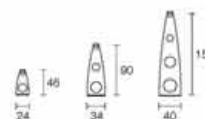

A richiesta connettori stagni IP68 per file continue max 30 apparecchi. codice _/FC (AD ESCLUSIONE DELLA VERSIONE 33.5 cm)
On request in and out IP68 connection for continuous line max 30 fittings. code _/FC (EXCLUDING THE 33.5 cm VERSION)

Esempio di ordinazione
Ordering example: E9032-LBC-25/FC



ALIMENTATORI-KIT RGB (se non in dotazione) da ordinare dalla sezione arancio - DRIVERS-RGB KITS (when not supplied) to be ordered from the section orange color







- Tubo in policarbonato trasparente.
- Dissipatore interno al tubo in alluminio anodizzato.
- Ottica orientabile.
- Staffe di fissaggio a muro in acciaio inox.
- Pressacavo in ottone nichelato.
- Lunghezza cavo 2 m.

- Transparent polycarbonate tube.
- Heatsink inside the tube made of anodized aluminium.
- Adjustable optic.
- Wall fixing brackets made of inox steel.
- Nickel brass cable gland.
- Cable lenght 2 m.

LINEARI - LINEAR
MICRO LEDLINE TONDO



			L [mm]	W	lm	V	K	CRI
VERSIONE ALTA EFFICIENZA - HIGHT EFFICIENCY VERSION								
		Als E961-LBC	1050	tot. 14,4W	1080	24Vdc	3000	>90
		E961-LBN		1170	4000			
		E961-LBI		1220	5000			
		Als E962-LBC	2050	tot. 28,8W	2160	24Vdc	3000	>90
		E962-LBN		2340	4000			
		E962-LBI		2440	5000			
		Als E963-LBC	3050	tot. 43,2W	3240	24Vdc	3000	>90
		E963-LBN		3510	4000			
		E963-LBI		3660	5000			

- OP. A richiesta disponibile 12 Vdc - On request available 12 Vdc
- A richiesta con tubo opale - On request with opal tube
- A richiesta con doppio pressacavo - On request with double cable gland

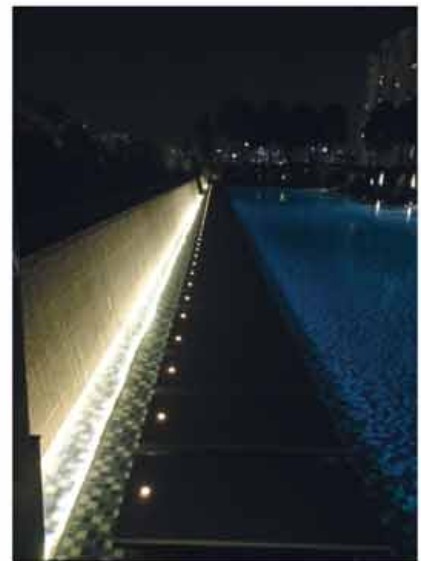

outside

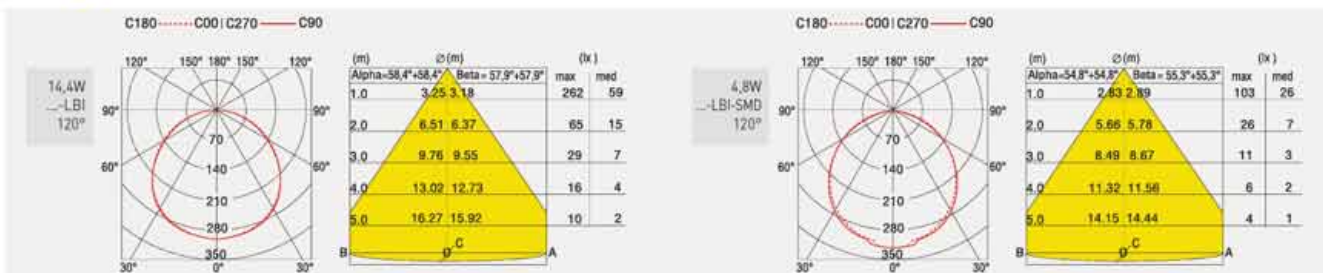

ALIMENTATORI-KIT RGB (se non in dotazione) da ordinare dalla sezione arancio - DRIVERS-RGB KITS (when not supplied) to be ordered from the section orange color





MINI LEDLINE TONDO

- Tubo in policarbonato.
- Dissipatore interno al tubo, corpo interno e testate in alluminio anodizzato.
- Ottica orientabile.
- Staffe di fissaggio a muro in acciaio inox.
- Pressacavo in ottone nichelato.
- Led durata utile: 25.000 (h) L80 B20.
- Cavo H05RN-F lunghezza. 2 mt.

- Polycarbonate tube.
- Internal body heatsink and heads made of anodized aluminium.
- Adjustable optic.
- Wall fixing brackets made of inox steel.
- Nickel brass cable gland.
- Cable H05RN-F length. 2 mt.
- Led life: 25.000 (h) L80 B20.



					L [mm]	W	lm	V	K	CRI
VERSIONE SMD CON SCHERMO TRASPARENTE - SMD VERSION WITH TRANSPARENT SCREEN										
		Als	E953-LBC		572	14,4W	1080	24Vdc	3000	>90
			E953-LBN				1170		4000	
			E953-LBI				1220		5000	
		Als	E954-LBC		1072	28,8W	2160	24Vdc	3000	>90
			E954-LBN				2946		4000	
			E954-LBI				2440		5000	
		Als	E955-LBC		1572	43,2W	3240	24Vdc	3000	>90
			E955-LBN				3510		4000	
			E955-LBI				3660		5000	
		Als	E956-LBC		2072	57,6W	4920	24Vdc	3000	>90
			E956-LBN				4620		4000	
			E956-LBI				4880		5000	
		Als	E922-RGB		572	9W	-	24Vdc		-
		Als	E924-RGB		572	9,4W	-	24Vdc		-
		Als	E926-RGB		1072	13,7W	-	24Vdc		-
		Als	E928-RGB		1572	18W	-	24Vdc		-
		Als	E930-RGB		2072	35,4W	-	24Vdc		-

OP. A richiesta - On request versione - version 12Vdc

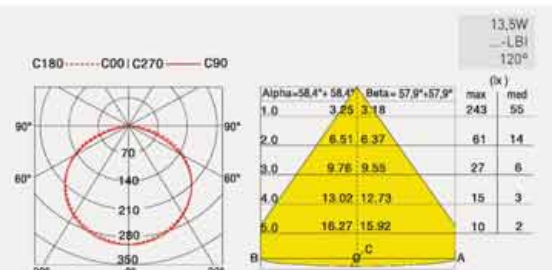
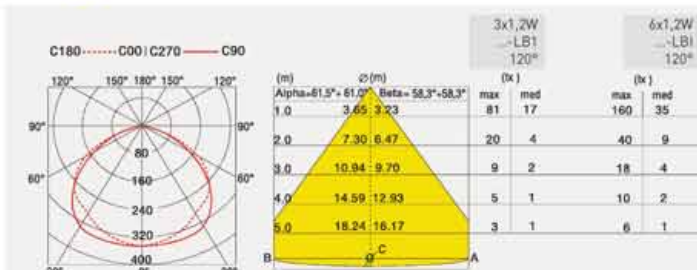

ALIMENTATORI-KIT RGB (se non in dotazione) da ordinare dalla sezione arancio - DRIVERS-RGB KITS (when not supplied) to be ordered from the section orange color

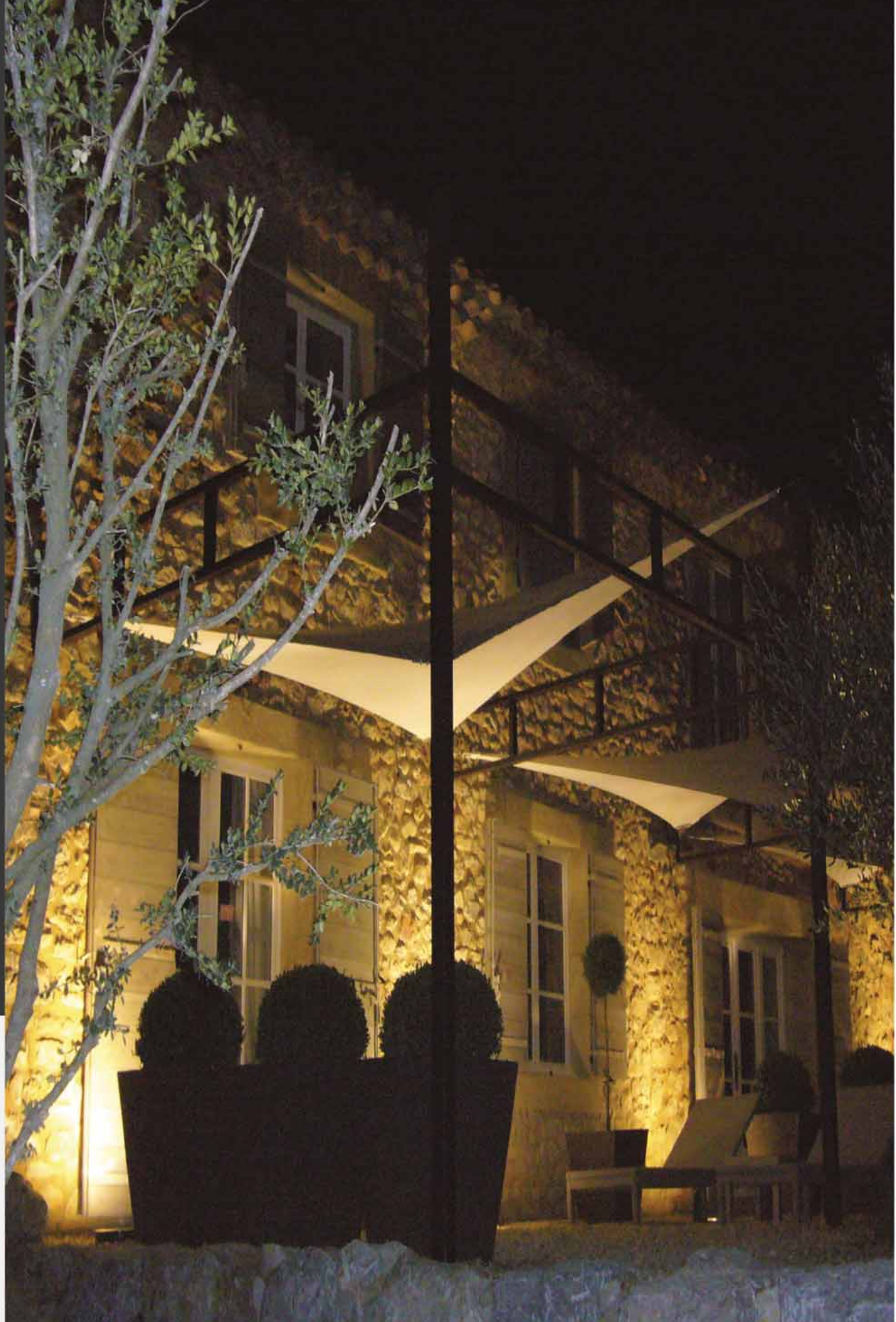

SPOT
SPOT 4



- Staffa in acciaio inox.
- Corpo in alluminio pressofuso.
- Vetro di protezione.
- Guarnizioni in gomma siliconica.
- Cavo di alimentazione lunghezza 1 m.
- Profondità d'installazione 1 m. max.

- Stainless steel inox bracket.
- Die-cast aluminium body.
- Protection glass.
- Silicon rubber gaskets.
- Power cable length 1 m.
- Max depth 1 m.



	Gr	E920-LBC E920-LBN E920-LBL	4x12W	420 465 -	350mA	3000 4000 470nm	>90

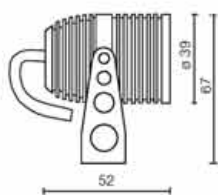

ALIMENTATORI CONSIGLIATI - RECOMMENDED DRIVERS

644758	ON-OFF	6W	IP20	350mA
644759-1	ON-OFF	15W	IP20	350mA
646258-67	ON-OFF	13W	IP20	350mA
644940	ON-OFF	12W	IP40	700mA
644936	ON-OFF	25W	IP40	700mA
644940-67	ON-OFF	12W	IP40	700mA
644936-67	ON-OFF	27W	IP40	700mA



OP. *A richiesta - On request: apertura fascio - light beam colorazioni bianco Br - nero Ne - cromato Cr - colour white Br - black Ne - chrome Cr disponibile - available

ACC. Baseplate con alimentatore - Base plate with transformer

E8005	350mA	IP65			
E8007	Picchetto da interrare in acciaio INOX - Stainless steel pike for ground installation a)				
E8004	Picchetto per baseplate - Pike for base plate b)				

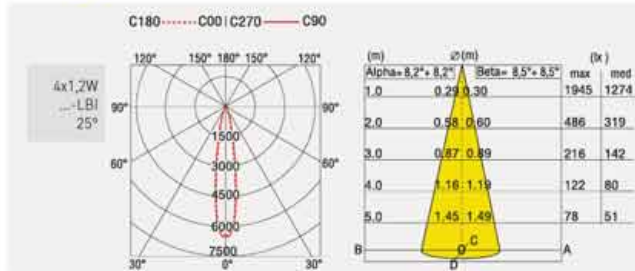

ALIMENTATORI-KIT RGB (se non in dotazione) da ordinare dalla sezione arancio - DRIVERS-RGB KITS (when not supplied) to be ordered from the section orange color



SPOT 7 - SPOT MCL



- Staffa in acciaio inox.
- Corpo in alluminio verniciato.
- Vetro di protezione.
- Guarnizioni in gomma silconica.
- Cavo di alimentazione lunghezza 1 m.
- Profondità d'installazione 1 m. max.
- Stainless steel inox bracket.
- Die-cast aluminium body.
- Protection glass.
- Silicon rubber gaskets.
- Power cable length 1 m.
- Max depth 1 m.



SPOT 7

SPOT MCL

	IP68	SPOT 7	LED					SISTEMA-SYSTEM		
			W	lm	V	K	CRI	W	lm	lm/W
		E921-LBC	7x1,2W	566	350mA	3000	>90	8W	464	58
		E921-LBI	630	6000	470nm	574	72			
		E921-LBL	-	-	-	-	-	-		
ALIMENTATORI CONSIGLIATI - RECOMMENDED DRIVERS										
644759-1	ON-OFF	15W	IP20	350mA						
646258-1	ON-OFF	13W	IP67	350mA						
OR: *A richiesta - On request; apertura fascio - light beam										
colorazioni bianco Br - nero Ne - cromato Cr - colour white Br - black Ne - chrome Cr										

	IP68	SPOT MCL	LED					SISTEMA-SYSTEM		
			W	lm	V	K	CRI	W	lm	lm/W
		E919-LBC-25	8,8W	1220	250mA	3000	>90	9,8W	1105	113
		E919-LBN-25	9W	900	500mA	4000	752	82		
		E919-LBC-40	8,8W	1220	250mA	3000	>90	9,8W	1120	115
		E919-LBN-40	9W	900	500mA	4000	825	83		
ALIMENTATORI CONSIGLIATI - RECOMMENDED DRIVERS										
645981	ON-OFF	9W	IP20	250mA						
646421	ON-OFF	10W	IP67	250mA						
645086	ON-OFF	20W	IP20	500mA						
645626-1	ON-OFF	20W	IP65	500mA						
OR: *A richiesta - On request; disponibile - available										



ACC. Basetta con alimentatore - Base plate with transformer

E8008 per SPOT 7 350mA IP65
E8009 per SPOT MCL 500mA IP65

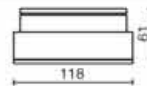

E8007 Picchetto da interrare in acciaio INOX - Stainless steel pike for ground installation a)
E8004 Picchetto per basetta - Pike for base plate b)

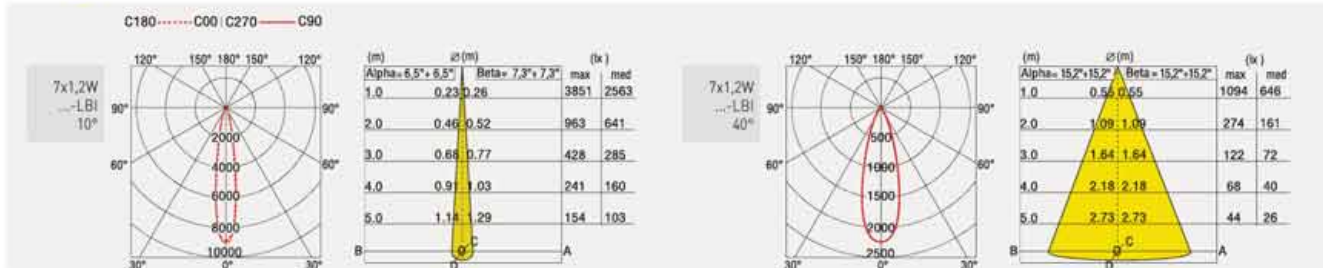
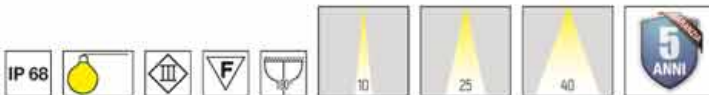
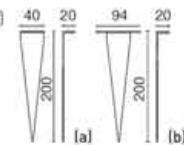

ALIMENTATORI-KIT RGB (se non in dotazione) da ordinare dalla sezione arancio - DRIVERS-RGB KITS (when not supplied) to be ordered from the section orange color



SPOT 35



- Corpo in alluminio.
- Verniciatura di polveri di poliestere con trattamento speciale per esterni.
- Staffa in acciaio Inox (AISI 316L) verniciato.
- Bloccacavo in acciaio inox.
- Cavo alimentazione 0,5m.
- Sorgente luminosa a Led 3SDCM.
- Vetro di protezione temprato extrachiaro serigrafato, resistente ai graffi e urti.
- Driver integrato.

- Aluminum body.
- Polyester powder painting with special treatment for outdoor use.
- Painted stainless steel (AISI 316L) bracket.
- Stainless steel bracket.
- Power supply cable 0.5m.
- 3SDCM Led light source.
- Extra clear serigraphy safety glass, resistant to scratches and bumps.
- Built-in driver.



	Gr	Ne	Bw	Ve	LED					SISTEMA-SYSTEM			
					W	lm	V	K	CRI	W	lm	lm	
	Gr	E67910-LBC-S	E67910-LBC-FL										
	Ne	E67911-LBC-S	E67911-LBC-FL										
	Bw	E67912-LBC-S	E67912-LBC-FL										
	Ve	E67913-LBC-S	E67913-LBC-FL										
	Gr	E67910-LBN-S	E67910-LBN-FL										
	Ne	E67911-LBN-S	E67911-LBN-FL										
	Bw	E67912-LBN-S	E67912-LBN-FL										
	Ve	E67913-LBN-S	E67913-LBN-FL										

ACC. 3137 Cinghia fissaggio ai rami - Fastening strap for three branch use



E1031 Picchetto da interrare - Spike for ground installation



3150-GR Asta con picchetto in acciaio inox - Rod with stainless steel spike
 3150-NE
 3150-BW
 3150-VE

L=600



3151-GR Asta con picchetto in acciaio inox - Rod with stainless steel spike
 3151-NE
 3151-BW
 3151-VE

L=1200







- Corpo in pressofusione di alluminio.
- Verniciatura di polveri di poliestere con trattamento speciale per esterni.
- Staffa in acciaio Inox (AISI 316L) verniciato.
- Bloccacavo in acciaio inox.
- Cavo alimentazione 0,5m.
- Sorgente luminosa a Led 3SDCM.
- Vetro di protezione temprato extrachiaro serigrafato, resistente ai graffi e urti.
- Driver integrato.

- Die-cast aluminum body.
- Polyester powder painting with special treatment for outdoor use.
- Painted stainless steel (AISI 316L) bracket.
- Brackets in stainless steel.
- Power supply cable 0.5m.
- 3SDCM Led light source.
- Extra clear serigraphy safety glass, resistant to scratches and bumps.
- Built-in driver.



	19	38	56	LED			SISTEMA-SYSTEM			
				W	Im	V	K	CRI	W	Im
Gr E67900-LBC-S	E67900-LBC-FL	E67900-LBC-WF	7W	827	220-240V [200mA]	3000	>90	8W	744	93
Ne E67901-LBC-S	E67901-LBC-FL	E67901-LBC-WF								
Bw E67902-LBC-S	E67902-LBC-FL	E67902-LBC-WF								
Ve E67903-LBC-S	E67903-LBC-FL	E67903-LBC-WF								
Gr E67900-LBN-S	E67900-LBN-FL	E67900-LBN-WF	7W	880	220-240V [200mA]	4000	>90	8W	792	99
Ne E67901-LBN-S	E67901-LBN-FL	E67901-LBN-WF								
Bw E67902-LBN-S	E67902-LBN-FL	E67902-LBN-WF								
Ve E67903-LBN-S	E67903-LBN-FL	E67903-LBN-WF								

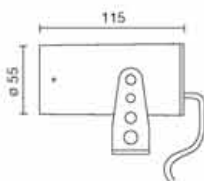

kg
0,475

ACC.	Gr	Descrizione	Immagine
	3147-GR	Cilindro di schermatura - Shielding cylinder	
	3147-NE		
	3147-BW		
	3147-VE		
	3148-GR	Cilindro di schermatura a 45° - 45° Shielding cylinder	
	3148-NE		
	3148-BW		
	3148-VE		
	3149-GR	Cornice porta accessori - Frame holder for accessory	
	3149-NE		
	3149-BW		
	3149-VE		
	3146	Griglia alveolare - Alveolar grid	
	3145	Lente ellittica - Elliptical lens	
	3144	Lente diffusiva - Wide flood	
	3137	Cinghia fissaggio ai rami - Fastening strap for three branch use	
	E1031	Picchetto da interrare - Pike for ground installation	
	3150-GR	Asta con picchetto in acciaio inox - Rod with stainless steel spike	
	3150-NE		
	3150-BW		
	3150-VE		
	3151-GR	Asta con picchetto in acciaio inox - Rod with stainless steel spike	
	3151-NE		
	3151-BW		
	3151-VE		

Ordinare anche la cornice porta accessori 3149-...
It is necessary also the frame holder 3149-...

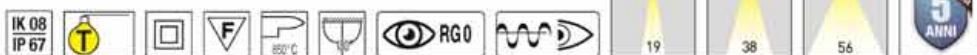

ALIMENTATORI-KIT RGB (se non in dotazione) da ordinare dalla sezione arancio - DRIVERS-RGB KITS (when not supplied) to be ordered from the section orange color



SPOT 70



- Corpo in pressofusione di alluminio.
- Verniciatura di polveri di poliestere con trattamento speciale per esterni.
- Staffa in acciaio Inox (AISI 316L) verniciato.
- Bloccacavo in acciaio inox.
- Cavo alimentazione 0,5m.
- Sorgente luminosa a Led 3SDCM.
- Vetro di protezione temprato extrachiario serigrafato, resistente ai graffi e urti.
- Driver integrato.



- Die-cast aluminum body.
- Polyester powder painting with special treatment for outdoor use.
- Painted stainless steel (AISI 316L) bracket.
- Brackets in stainless steel.
- Power supply cable 0.5m.
- 3SDCM Led light source.
- Extra clear serigraphy safety glass, resistant to scratches and bumps.
- Built-in driver.

	19	38	56	LED					SISTEMA-SYSTEM			
				W	lm	V	K	CRI	W	lm	W	
Gr E67886-LBC-S	E67886-LBC-FL	E67886-LBC-WF										
Ne E67887-LBC-S	E67887-LBC-FL	E67887-LBC-WF										
Bw E67888-LBC-S	E67888-LBC-FL	E67888-LBC-WF										
Ve E67889-LBC-S	E67889-LBC-FL	E67889-LBC-WF										
Gr E67886-LBN-S	E67886-LBN-FL	E67886-LBN-WF										
Ne E67887-LBN-S	E67887-LBN-FL	E67887-LBN-WF										
Bw E67888-LBN-S	E67888-LBN-FL	E67888-LBN-WF										
Ve E67889-LBN-S	E67889-LBN-FL	E67889-LBN-WF										

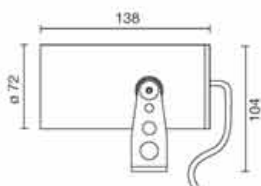

1,00 Kg

ACC.	Gr	3134-GR	Cilindro di schermatura - Shielding cylinder	
	Ne	3134-NE		
	Bw	3134-BW		
	Ve	3134-VE		
	Br	3133-GR	Cilindro di schermatura a 45° - 45° Shielding cylinder	
	Ne	3133-NE		
	Bw	3133-BW		
	Ve	3133-VE		
	Br	3136-GR	Cornice porta accessori - Frame holder for accessory	
	Ne	3136-NE		
	Bw	3136-BW		
	Ve	3136-VE		
	Ne	3131	Griglia alveolare - Alveolar grid	
		3129	Lente ellittica - Elliptical lens 22,00	
		3130	Lente diffondente - Wide flood	
		3137	Dinghia fissaggio ai rami - Fastening strap for three branch use	
	E1031		Picchetto da interrare - Pike for ground installation	
		3150-GR	Asta con picchetto in acciaio inox - Rod with stainless steel spike	L=600
		3150-NE		
		3150-BW		
		3150-VE		
		3151-GR	Asta con picchetto in acciaio inox - Rod with stainless steel spike	L=1200
		3151-NE		
		3151-BW		
		3151-VE		

IK 08
IP 67



outside



- Corpo in pressofusione di alluminio.
- Verniciatura di polveri di poliestere con trattamento speciale per esterni.
- Staffa in acciaio Inox (AISI 316L) verniciato.
- Bloccacavo in acciaio inox.
- Cavo alimentazione 0,5m.
- Sorgente luminosa a Led 3SDCM.
- Vetro di protezione temprato extrachiaro serigrafato, resistente ai graffi e urti.
- Driver integrato.

- Die-cast aluminum body.
- Polyester powder painting with special treatment for outdoor use.
- Painted stainless steel (AISI 316L) bracket.
- Brackets in stainless steel.
- Power supply cable 0.5m.
- 3SDCM Led light source.
- Extra clear serigraphy safety glass, resistant to scratches and bumps.
- Built-in driver.



	19	38	56	LED			SISTEMA-SYSTEM				
				W	lm	V	K	CRI	W	lm	lp
Gr E67895-LBC-S	E67895-LBC-FL	E67895-LBC-WF		25W	3179	220-240V (700mA)	3000	>90	29W	2861	99
Ne E67896-LBC-S	E67896-LBC-FL	E67896-LBC-WF									
Bw E67897-LBC-S	E67897-LBC-FL	E67897-LBC-WF									
Ve E67898-LBC-S	E67898-LBC-FL	E67898-LBC-WF									
Gr E67895-LBN-S	E67895-LBN-FL	E67895-LBN-WF		25W	3410	220-240V (700mA)	4000	>90	29W	3069	106
Ne E67896-LBN-S	E67896-LBN-FL	E67896-LBN-WF									
Bw E67897-LBN-S	E67897-LBN-FL	E67897-LBN-WF									
Ve E67898-LBN-S	E67898-LBN-FL	E67898-LBN-WF									

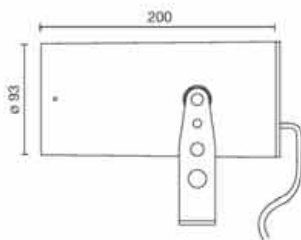

1kg
1750

OP. A richiesta - On request: disponibile - available

ACC. Gr 3141-GR Cilindro di schermatura - Shielding cylinder
Ne 3141-NE
Bw 3141-BW
Ve 3141-VE



Br 3142-GR Cilindro di schermatura a 45° - 45° Shielding cylinder
Ne 3142-NE
Bw 3142-BW
Ve 3142-VE



Br 3143-GR Cornice porta accessori - Frame holder for accessory
Ne 3143-NE
Bw 3143-BW
Ve 3143-VE



Ne 3140 Griglia alveolare - Alveolar grid



3139 Lente ellittica - Elliptical lens



3138 Lente diffondente - Wide flood



3137 Cinghia fissaggio ai rami - Fastening strap for three branch use



E1031 Picchetto da interrare - Pike for ground installation



Ordinare anche la cornice porta accessori 3143-...
It is necessary also the frame holder 3143-...





MICRO REEF MCL



- Corpo orientabile in pressofusione di alluminio.
 - Staffa regolabile verniciata.
 - Verniciatura in poliestere con pretrattamento speciale per esterni.
 - Vetro trasparente extrachiaro.
 - Bloccacavo in ottone nichelato PG7.
 - Guarnizioni in silicone resistente ad alte temperature.
 - Cavo di alimentazione lunghezza 1 m.
 - Led durata utile: 50.000 (h) L80 B10.
- Die-cast aluminium body.
 - Adjustable bracket painted.
 - Polyester painted after pre-treatment for outdoor use.
 - Transparent extra clear glass.
 - Cable gland of nickel plated brass PG7.
 - Silicon gasket high temperature resistant.
 - Power cable length 1 m.
 - Led life: 50.000 (h) L80 B10.

	Br	Ne	Gr	LED					SISTEMA-SYSTEM			
				W	lm	V	K	CRI	W	lm	lm	
	E1085-LBC-10	E1085-LBC-25		9W	850	220-240V (250mA)	3000	>90	10W	758	76	[10°]
	E1086-LBC-10	E1086-LBC-25								730	75	[25°]
	E1087-LBC-10	E1087-LBC-25										
	E1085-LBN-10	E1085-LBN-25		9W	900	220-240V (250mA)	4000	>90	10W	822	82	[10°]
	E1086-LBN-10	E1086-LBN-25								790	79	[25°]
	E1087-LBN-10	E1087-LBN-25										

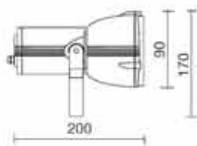

0,90 Kg

ACC.	Br	Ne	Gr	
	E1035	E1036	E1037	Palpebra - Eyelid
	E1031			Picchetto inox - Inox pike

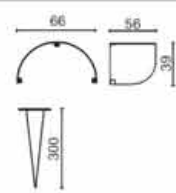

outside

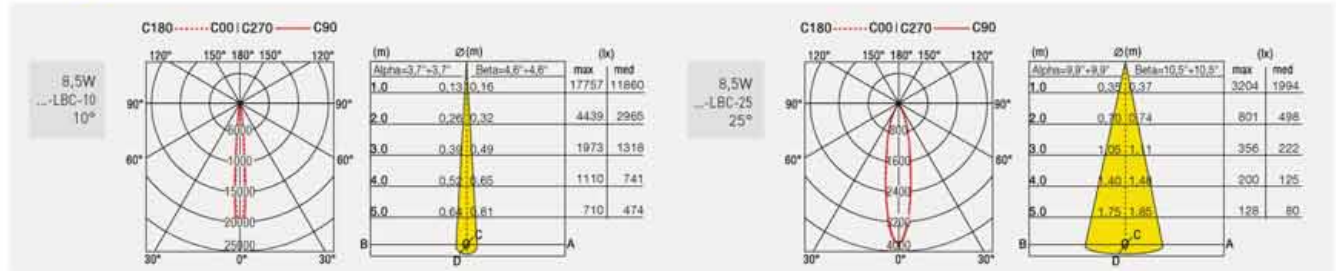

ALIMENTATORI-KIT RGB (se non in dotazione) da ordinare dalla sezione arancio - DRIVERS-RGB KITS (when not supplied) to be ordered from the section orange color



MINI REEF MCL



- Corpo orientabile in pressofusione di alluminio.
- Staffa regolabile verniciata.
- Verniciatura in poliestere con pretrattamento speciale per esterni.
- Vetro trasparente.
- Bloccacavo in ottone nichelato PG11.
- Guarnizioni in silicone resistente ad alte temperature.
- Cavo di alimentazione lunghezza 2 m.

- Die-cast aluminium body.
- Adjustable bracket painted.
- Polyester painted after pre-treatment for outdoor use.
- Transparent glass.
- Cable gland of nickel plated brass PG11.
- Silicon gasket high temperature resistant.
- Power cable length 2 m.

	15	30	90	LED			SYSTEM-SYSTEM					
				W	lm	V	K	CR1	W	lm	lp	
Br E1080-LBC	E1074-LBC	E1077-LBC		29W	3950	220-240V	3000	>90	33W	3235	98	(15°)
Ne E1081-LBC	E1075-LBC	E1078-LBC				(850mA)				2916	88	(30°)
Gr E1082-LBC	E1076-LBC	E1079-LBC								2970	90	(60°)
Br E1080-LBN	E1074-LBN	E1077-LBN		29W	4195	220-240V	4000	>90	33W	3418	104	(15°)
Ne E1081-LBN	E1075-LBN	E1078-LBN				(850mA)				3081	94	(30°)
Gr E1082-LBN	E1076-LBN	E1079-LBN								3140	95	(60°)

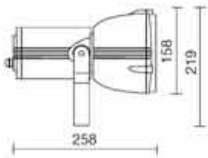

2,80 Kg

OP. A richiesta - On request. Led con temperatura di COLORE 2700K - Temperature Led COLOUR 2700K

ACC.

Br E1067			
Ne E1068	Palpebra - Eyelid		
Gr E1069			
E1031	Picchetto inox - Inox pike		
Br E1070			
Ne E1071	Aletta singola - Single flap		
Gr E1072			

Ne E1038 Kit attacco palo - Pole bracket kit

Gr E1039

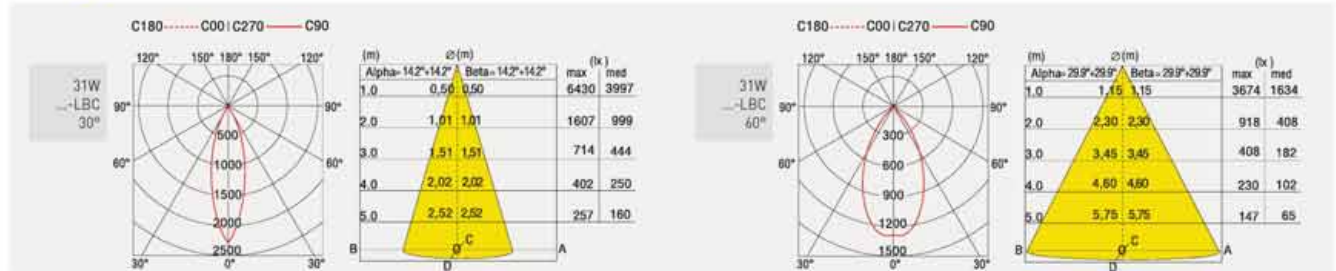

ALIMENTATORI-KIT RGB (se non in dotazione) da ordinare dalla sezione arancio - DRIVERS-RGB KITS (when not supplied) to be ordered from the section orange color



--	--	--	--	--	--	--	--	--	--	--

ALIMENTATORI-KIT RGB (se non in dotazione) da ordinare dalla sezione arancio - DRIVERS-RGB KITS (when not supplied) to be ordered from the section orange color





REEF MCL - REEF RGB

- Corpo orientabile in pressofusione di alluminio.
- Staffa regolabile verniciata.
- Verniciatura in poliestere con pretrattamento speciale per esterni.
- Vetro borosilicato trasparente.
- Bloccacavo in ottone nichelato PG13,5.
- Guarnizioni in silicone resistente ad alte temperature.
- Cavo di alimentazione lunghezza 2 m.

- Die-cast aluminium body.
- Adjustable bracket painted.
- Polyester painted after pre-treatment for outdoor use.
- Transparent borosilicate glass.
- Cable gland of nickel plated brass PG13,5.
- High temperature resistant silicon gasket.
- Power cable length 2 m.



	15	25	40	LED		V	K	CRI	SISTEMA-SYSTEM			
				W	lm				W	lm	IP	
REEF MCL												
Ne	E1027-LBC-15	E1027-LBC-25	E1027-LBC-40	40W	6000	220-240V (1750mA)	3000	>90	44W	5444	124	(15°)
Gr	E1028-LBC-15	E1028-LBC-25	E1028-LBC-40							5405	123	(25°)
Ne	E1027-LBN-15	E1027-LBN-25	E1027-LBN-40	40W	6250	220-240V (1750mA)	4000	>90	44W	5670	129	(15°)
Gr	E1028-LBN-15	E1028-LBN-25	E1028-LBN-40							5630	128	(25°)
OP.	*A richiesta: apertura fascio - On request: light beam disponibile - available								65			

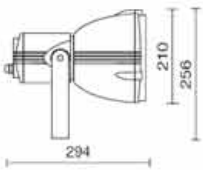

	10	30	45	W	lm	V	K	CRI
Ne	E1010-RGB-10	E1010-RGB-30	E1010-RGB-45	15x1,2W		350mA		
Gr	E1011-RGB-10	E1011-RGB-30	E1011-RGB-45					
ACC.	PER VERSIONE RGB - FOR RGB VERSION							
	644892-1	Alimentatore - Driver MASTER		IP20	7W	350mA		
	644892-4	Alimentatore - Driver SLAVE		IP20	7W	350mA		
	646375	Alimentatore - Driver		IP20	50W	350mA DMX		
	645262	Centralina DMX - DMX Control gear case		IP20		12Vac		

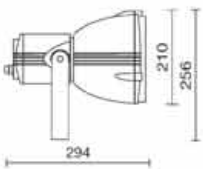

DP.	A RICHIESTA: VERSIONE RGBW POTENZA TOTALE 57,5W - ON REQUEST: RGBW VERSION TOTAL POWER 57,5W							
	E1010-RGBW-35	Apparecchio - Fitting						
	E1010-RGBW-20	Apparecchio - Fitting						
	646375	Alimentatore - Driver						
	645262	Centralina DMX - DMX Control gear case						

ESEMPIO ORDINAZIONE - ORDER EXAMPLING
E1010-RGBW-35 • 646375 • 645262

ACC.	Ne	E1020	Palpebra - Eyelid	
	Gr	E1021		
		E1030	Picchetto inox - Inox pike	
	Ne	E1025	Aletta singola - Single flap	
	Gr	E1026		
	Ne	E1038	Kit attacco palo - Pole bracket kit	
	Gr	E1039		

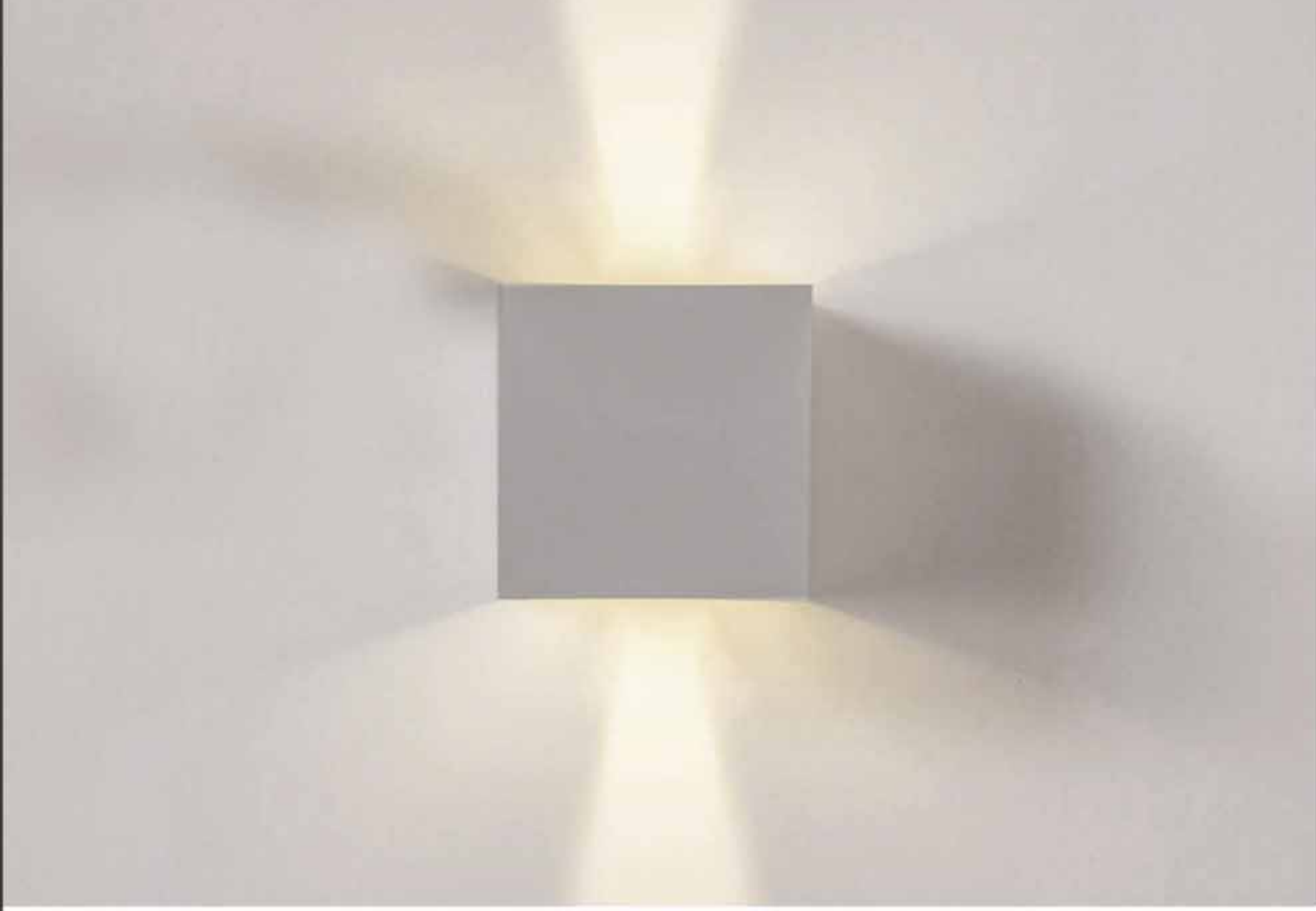



EFFETTI LUMINOSI LIGHT EFFECTS

outside



**SMALL-BLADE
ROUND**
596



**SMALL-BLADE
SQUARE**
597



**SMALL-BLADE
SQUARE LONG**
599



NEOS T
600



NEOS Q
602



LI-LED
605



LI-LED ST
607

SMALL-BLADE ROUND

- Modulo da incasso a muro per scatola elettrica tipo 503E in dotazione.
- Corpo in alluminio pressofuso.
- Verniciatura in polveri poliestere previo trattamento speciale per esterni.
- Viti in acciaio Inox.
- Corpo e dissipatore interno in ottone nichelato.
- Lente in metacrilato e guarnizioni in gomma silconica.
- Cavo di alimentazione 0,2 m. e connettori per cablaggi a tenuta stagna in dotazione.

- Wall recessed fitting for supplied electrical boxes type 503E.
- Die-cast aluminium body.
- Powder coated with pretreatment for outdoor use.
- Inox steel screws.
- Body and internal heatsink made of nichel plated brass.
- Methacrylate lens and gasket glands of silicone rubber.
- Power cable 0,2 m. long and connectors for watertight wiring supplied.

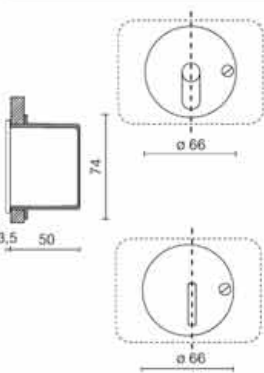

ALLOGGIAMENTO A PRESSIONE - PRESSURE FIXING							
Br	E909BR-LBC	E951BR-LBC	1x2W	145	500mA	5000	>80
Ne	E909NE-LBC	E951NE-LBC					
Gr	E909-LBC	E951-LBC					
ALLOGGIAMENTO CON VITI - SCREWS FIXING							
Br	E909BR-LBN	E951BR-LBN	1x2W	155	500mA	4000	>80
Ne	E909NE-LBN	E951NE-LBN					
Gr	E909-LBN	E951-LBN					
Br	E909BR-LBI	E951BR-LBI	1x2W	165	500mA	6000	>80
Ne	E909NE-LBI	E951NE-LBI					
Gr	E909-LBI	E951-LBI					
Br	E909BR-LBL	E951BR-LBL	1x2W	-	500mA	470nm	>80
Ne	E909NE-LBL	E951NE-LBL					
Gr	E909-LBL	E951-LBL					

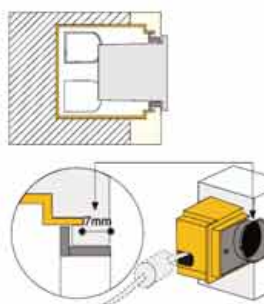

Br	E909BR-LBN-V	E951BR-LBN-V	1x2W	155	500mA	4000	>80	
Ne	E909NE-LBN-V	E951NE-LBN-V						
Gr	E909-LBN-V	E951-LBN-V						
Br	E909BR-LBI-V	E951BR-LBI-V	1x2W	165	500mA	6000	>80	
Ne	E909NE-LBI-V	E951NE-LBI-V						
Gr	E909-LBI-V	E951-LBI-V						
Br	E909BR-LBL-V	E951BR-LBL-V	1x2W	-	500mA	470nm	>80	105,00
Ne	E909NE-LBL-V	E951NE-LBL-V						
Gr	E909-LBL-V	E951-LBL-V						



OP. A richiesta colorazioni piastra secondo tabella RAL - Colour on request according to RAL table

Scatola da immersione tipo 503E + adattatore in dotazione
Wall box type 503E + adaptor included

ALIMENTATORI CONSIGLIATI - RECOMMENDED DRIVERS						
644758-5	ON-OFF	6W	IP20	700mA		27,30
645626-1	ON-OFF	20W	IP65	500mA		53,00

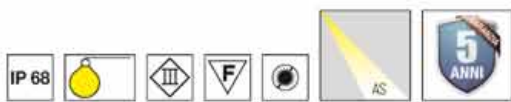

outside

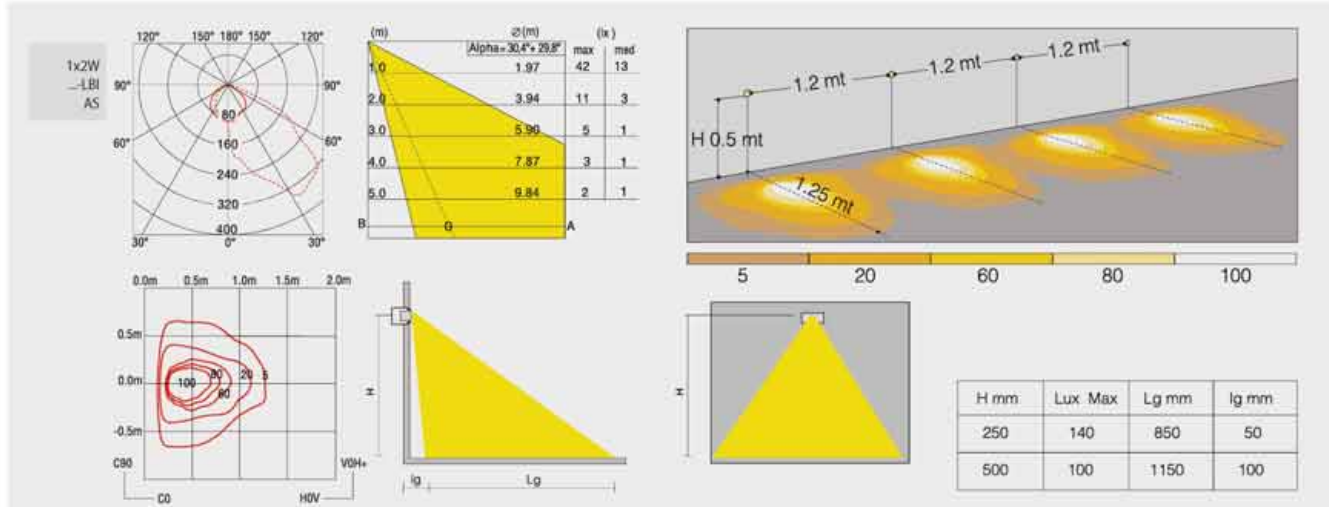



- Modulo da incasso a muro per scatola elettrica tipo 503E in dotazione.
- Corpo in alluminio pressofuso.
- Verniciatura in polveri poliestere previo trattamento speciale per esterni.
- Viti in acciaio Inox.
- Corpo e dissipatore interno in ottone nichelato.
- Lente in metacrilato e guarnizioni in gomma silconica.
- Cavo di alimentazione 0,2 m.e connettori per cablaggi a tenuta stagna in dotazione.



- Wall recessed fitting for supplied electrical boxes type 503E.
- Die-cast aluminium body.
- Powder coated with pretreatment for outdoor use.
- Inox steel screws.
- Body and internal heatsink made of nichel plated brass.
- Methacrylate lens and gasket glands of silicone rubber.
- Power cable 0.2 m. long and connectors for watertight wiring supplied.

		W	lm	V	K	CRI
ALLOGGIAMENTO A PRESSIONE - PRESSURE FIXING						
Br	E909BR-Q-LBC	E951BR-Q-LBC				
Ne	E909NE-Q-LBC	E951NE-Q-LBC	1x2W	145	500mA	3000
Gr	E909-Q-LBC	E951-Q-LBC				>80
ALLOGGIAMENTO CON VITI - SCREWS FIXING						
Br	E909BRQ-LBN-V	E951BRQ-LBN-V				
Ne	E909NEQ-LBN-V	E951NEQ-LBN-V	1x2W	155	500mA	4000
Gr	E909-Q-LBN-V	E951-Q-LBN-V				>80
Br	E909BRQ-LBI-V	E951BRQ-LBI-V				
Ne	E909NEQ-LBI-V	E951NEQ-LBI-V	1x2W	165	500mA	6000
Gr	E909-Q-LBI-V	E951-Q-LBI-V				>80
Br	E909BRQ-LBL-V	E951BRQ-LBL-V				
Ne	E909NEQ-LBL-V	E951NEQ-LBL-V	1x2W	-	500mA	470nm
Gr	E909-Q-LBL-V	E951-Q-LBL-V				>80

OR: A richiesta colorazioni piastra secondo tabella RAL - Colour on request according to RAL table

ALIMENTATORI CONSIGLIATI - RECOMMENDED DRIVERS					
644758-5	ON-OFF	6W	IP20	700mA	
645626-1	ON-OFF	20W	IP65	500mA	

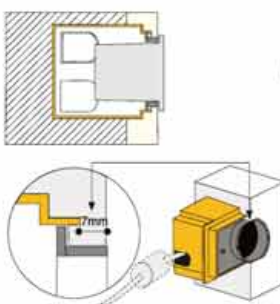
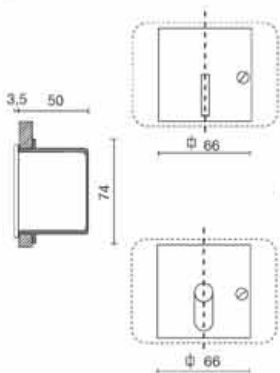

Scatola da immergere tipo 503E + adattatore in dotazione
 Wall box type 503E + adaptor included

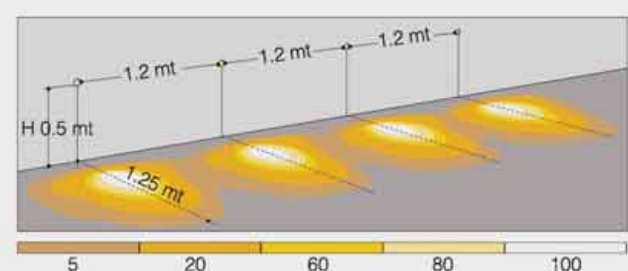
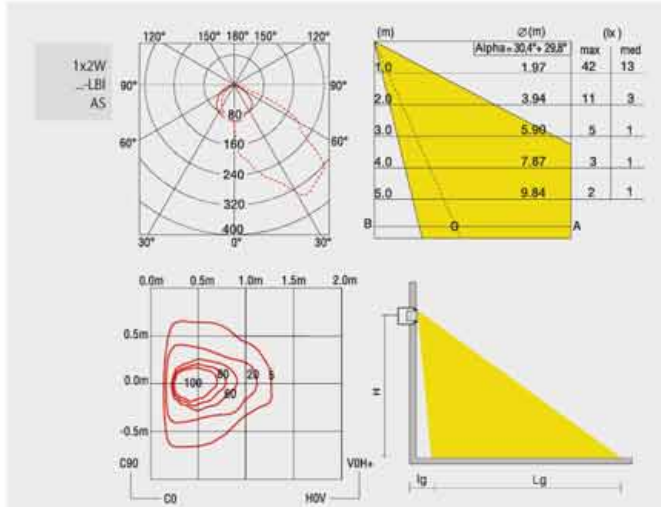

H mm	Lux Max	Lg mm	lg mm
250	140	850	50
500	100	1150	100

ALIMENTATORI-KIT RGB (se non in dotazione) da ordinare dalla sezione arancio - DRIVERS-RGB KITS (when not supplied) to be ordered from the section orange color



IP 68 apparecchi/fitting
IP 67 driver



outside

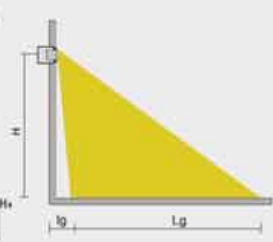
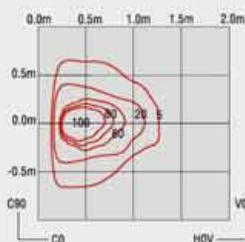
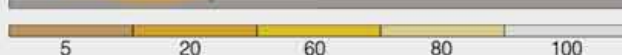
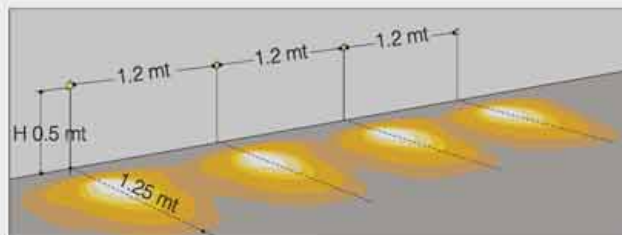
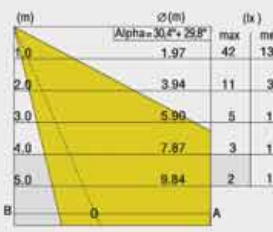
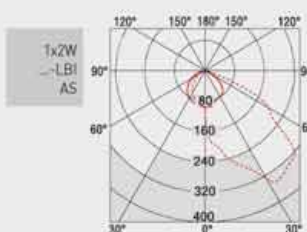

H mm	Lux Max	Lg mm	lg mm
250	140	850	60
500	100	1150	100

ALIMENTATORI-KIT RGB (se non in dotazione) da ordinare dalla sezione arancio - DRIVERS-RGB KITS (when not supplied) to be ordered from the section orange color



SMALL-BLADE SQUARE LONG

- Modulo da incasso a muro per scatola elettrica tipo 503E in dotazione.
- Corpo in alluminio pressofuso.
- Verniciatura in polveri poliestere previo trattamento speciale per esterni.
- Viti in acciaio Inox.
- Corpo e dissipatore interno in ottone nichelato.
- Lente in metacrilato e guarnizioni in gomma siliconica.
- Cavo di alimentazione 0,2 m. e connettori per cablaggi a tenuta stagna in dotazione.

- Wall recessed fitting for supplied electrical boxes type 503E.
- Die-cast aluminium body.
- Powder coated with pretreatment for outdoor use.
- Inox steel screws.
- Body and internal heatsink made of nichel plated brass.
- Methacrylate lens and gasket gland made of silicone rubber.
- Power cable 0,2 m. long and connectors for watertight wiring supplied.



			(W)	(lm)	(V)	(K)	(CRI)
Br	E909BR-L-LBC	E951BR-L-LBC	1x2W	145	220-240V (500mA)	3000	>80
Ne	E909NE-L-LBC	E951NE-L-LBC					
Gr	E909-L-LBC	E951-L-LBC					
Br	E909BR-L-LBN	E951BR-L-LBN	1x2W	155	220-240V (500mA)	4000	>80
Ne	E909NE-L-LBN	E951NE-L-LBN					
Gr	E909-L-LBN	E951-L-LBN					
Br	E909BR-L-LBI	E951BR-L-LBI	1x2W	165	220-240V (500mA)	6000	>80
Ne	E909NE-L-LBI	E951NE-L-LBI					
Gr	E909-L-LBI	E951-L-LBI					
Br	E909BR-L-LBL	E951BR-L-LBL	1x2W	-	220-240V (500mA)	470nm	>80
Ne	E909NE-L-LBL	E951NE-L-LBL					
Gr	E909-L-LBL	E951-L-LBL					

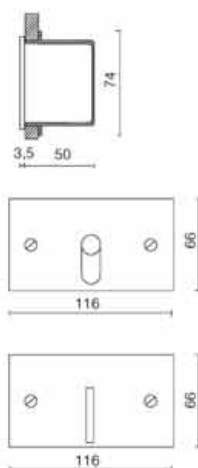

FRG 100



OP: A richiesta colorazioni piastra secondo tabella RAL - Plate colour on request according to RAL table

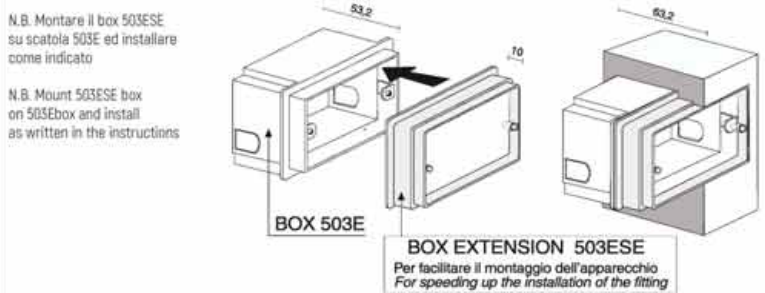
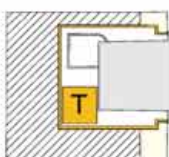

NEOS T

- Corpo e basetta in alluminio.
- Verniciatura in polveri poliestere previo trattamento speciale per esterni.
- Viteria in acciaio Inox.
- Vetri di sicurezza.
- Anelli di chiusura in acciaio Inox [AISI 316L].
- Guarnizioni e pressacavo di tenuta in gomma siliconica.
- Driver integrato.

- Body and base made of aluminium.
- Polyester powder coating with special treatment for outdoor use.
- Stainless steel screws.
- Safety glass.
- Stainless steel Inox AISI 316L caps.
- Seals and silicone rubber sealing gland.
- Build-in driver.



VERSIONE 2 LED - 2 LED VERSION							
Br	E5860T-LBC-10	E5860T-LBC-30	E5860T-LBC-45				
Ne	E5861T-LBC-10	E5861T-LBC-30	E5861T-LBC-45	2x2W	2X110	220-240V (500mA)	3000 >90
Gr	E5862T-LBC-10	E5862T-LBC-30	E5862T-LBC-45				
Bw	E5863T-LBC-10	E5863T-LBC-30	E5863T-LBC-45				
VERSIONE 2 LED - 2 LED VERSION							
Br	E5860T-LBN-10	E5860T-LBN-30	E5860T-LBN-45				
Ne	E5861T-LBN-10	E5861T-LBN-30	E5861T-LBN-45	2x2W	2X120	220-240V (500mA)	4000 >90
Gr	E5862T-LBN-10	E5862T-LBN-30	E5862T-LBN-45				
Bw	E5863T-LBN-10	E5863T-LBN-30	E5863T-LBN-45				
VERSIONE 2 LED - 2 LED VERSION							
Br	E5860T-LBL-10	E5860T-LBL-30	E5860T-LBL-45				
Ne	E5861T-LBL-10	E5861T-LBL-30	E5861T-LBL-45	2x2W	-	220-240V (500mA)	470nm >90
Gr	E5862T-LBL-10	E5862T-LBL-30	E5862T-LBL-45				
Bw	E5863T-LBL-10	E5863T-LBL-30	E5863T-LBL-45				
VERSIONE 3 LED - 3 LED VERSION							
Br	E5864T-LBC-10	E5864T-LBC-30	E5864T-LBC-45				
Ne	E5865T-LBC-10	E5865T-LBC-30	E5865T-LBC-45	3x2W	3X110	220-240V (500mA)	3000 >90
Gr	E5866T-LBC-10	E5866T-LBC-30	E5866T-LBC-45				
Bw	E5867T-LBC-10	E5867T-LBC-30	E5867T-LBC-45				
VERSIONE 3 LED - 3 LED VERSION							
Br	E5864T-LBN-10	E5864T-LBN-30	E5864T-LBN-45				
Ne	E5865T-LBN-10	E5865T-LBN-30	E5865T-LBN-45	3x2W	3X120	220-240V (500mA)	4000 >90
Gr	E5866T-LBN-10	E5866T-LBN-30	E5866T-LBN-45				
Bw	E5867T-LBN-10	E5867T-LBN-30	E5867T-LBN-45				
VERSIONE 3 LED - 3 LED VERSION							
Br	E5864T-LBL-10	E5864T-LBL-30	E5864T-LBL-45				
Ne	E5865T-LBL-10	E5865T-LBL-30	E5865T-LBL-45	3x2W	-	220-240V (500mA)	470nm >90
Gr	E5866T-LBL-10	E5866T-LBL-30	E5866T-LBL-45				
Bw	E5867T-LBL-10	E5867T-LBL-30	E5867T-LBL-45				

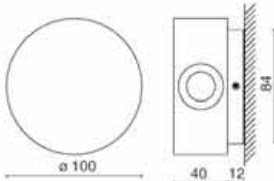

outside

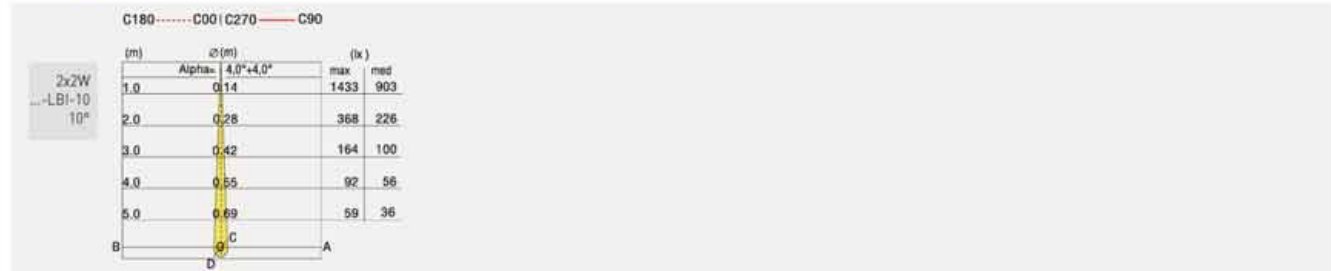

ALIMENTATORI-KIT RGB (se non in dotazione) da ordinare dalla sezione arancio - DRIVERS-RGB KITS (when not supplied) to be ordered from the section orange color

NEOS Q

- Corpo e basetta in alluminio.
- Verniciatura in polveri poliestere previo trattamento speciale per esterni.
- Viteria in acciaio Inox.
- Vetri di sicurezza.
- Anelli di chiusura in acciaio Inox [AISI 316L].
- Guarnizioni e pressacavo di tenuta in gomma siliconica.
- Driver integrato.

- Body and base made of aluminium.
- Polyester powder coating with special treatment for outdoor use.
- Stainless steel screws.
- Safety glass.
- Stainless steel Inox AISI 316L caps.
- Seals and silicone rubber sealing gland.
- Build-in driver.



				(W)	(lm)	(V)	(K)	(CRI)
VERSIONE 2 LED - 2 LED VERSION								
Br	E5860Q-LBC-10	E5860Q-LBC-30	E5860Q-LBC-45					
Ne	E5861Q-LBC-10	E5861Q-LBC-30	E5861Q-LBC-45	2x2W	2X110	220-240V (500mA)	3000	>90
Gr	E5862Q-LBC-10	E5862Q-LBC-30	E5862Q-LBC-45					
Bw	E5863Q-LBC-10	E5863Q-LBC-30	E5863Q-LBC-45					
VERSIONE 2 LED - 2 LED VERSION								
Br	E5860Q-LBN-10	E5860Q-LBN-30	E5860Q-LBN-45					
Ne	E5861Q-LBN-10	E5861Q-LBN-30	E5861Q-LBN-45	2x2W	2X120	220-240V (500mA)	6000	>90
Gr	E5862Q-LBN-10	E5862Q-LBN-30	E5862Q-LBN-45					
Bw	E5863Q-LBN-10	E5863Q-LBN-30	E5863Q-LBN-45					
VERSIONE 2 LED - 2 LED VERSION								
Br	E5860Q-LBL-10	E5860Q-LBL-30	E5860Q-LBL-45					
Ne	E5861Q-LBL-10	E5861Q-LBL-30	E5861Q-LBL-45	2x2W	-	220-240V (500mA)	470nm	>90
Gr	E5862Q-LBL-10	E5862Q-LBL-30	E5862Q-LBL-45					
Bw	E5863Q-LBL-10	E5863Q-LBL-30	E5863Q-LBL-45					
VERSIONE 3 LED - 3 LED VERSION								
Br	E5864Q-LBC-10	E5864Q-LBC-30	E5864Q-LBC-45					
Ne	E5865Q-LBC-10	E5865Q-LBC-30	E5865Q-LBC-45	3x2W	3X110	220-240V (500mA)	3000	>90
Gr	E5866Q-LBC-10	E5866Q-LBC-30	E5866Q-LBC-45					
Bw	E5867Q-LBC-10	E5867Q-LBC-30	E5867Q-LBC-45					
VERSIONE 3 LED - 3 LED VERSION								
Br	E5864Q-LBN-10	E5864Q-LBN-30	E5864Q-LBN-45					
Ne	E5865Q-LBN-10	E5865Q-LBN-30	E5865Q-LBN-45	3x2W	3X120	220-240V (500mA)	6000	>90
Gr	E5866Q-LBN-10	E5866Q-LBN-30	E5866Q-LBN-45					
Bw	E5867Q-LBN-10	E5867Q-LBN-30	E5867Q-LBN-45					
VERSIONE 3 LED - 3 LED VERSION								
Br	E5864Q-LBL-10	E5864Q-LBL-30	E5864Q-LBL-45					
Ne	E5865Q-LBL-10	E5865Q-LBL-30	E5865Q-LBL-45	3x2W	-	220-240V (500mA)	470nm	>90
Gr	E5866Q-LBL-10	E5866Q-LBL-30	E5866Q-LBL-45					
Bw	E5867Q-LBL-10	E5867Q-LBL-30	E5867Q-LBL-45					

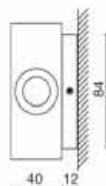

outside

C180 C00 | C270 — C90

(m)	∅(m)	Alpha 4,0°±4,0°	(lx)	
			max	med
1,0	0,14		1433	903
2,0	0,28		368	226
3,0	0,42		164	100
4,0	0,55		92	56
5,0	0,69		59	36



NEOS Q

- Corpo e basetta in alluminio.
- Verniciatura in polveri poliestere previo trattamento speciale per esterni.
- Viteria in acciaio Inox.
- Vetri di sicurezza.
- Anelli di chiusura in acciaio Inox (AISI 316L).
- Guarnizioni e pressacavo di tenuta in gomma siliconica.
- Driver integrato.

- Body and base made of aluminium.
- Polyester powder coating with special treatment for outdoor use.
- Stainless steel screws.
- Safety glass.
- Stainless steel Inox AISI 316L caps.
- Seals and silicone rubber sealing gland.
- Build-in driver.



(W)
(lm)
(V)
(K)
(CRI)



VERSIONE 4 LED - 4 LED VERSION

Br	E58680-LBC-10	E58680-LBC-30	E58680-LBC-45					
Ne	E58690-LBC-10	E58690-LBC-30	E58690-LBC-45	4x2W	4X110	220-240V (500mA)	3000	>90
Gr	E58700-LBC-10	E58700-LBC-30	E58700-LBC-45					
Bw	E58710-LBC-10	E58710-LBC-30	E58710-LBC-45					
Br	E58680-LBN-10	E58680-LBN-30	E58680-LBN-45					
Ne	E58690-LBN-10	E58690-LBN-30	E58690-LBN-45	4x2W	4X120	220-240V (500mA)	6000	>90
Gr	E58700-LBN-10	E58700-LBN-30	E58700-LBN-45					
Bw	E58710-LBN-10	E58710-LBN-30	E58710-LBN-45					
Br	E58680-LBL-10	E58680-LBL-30	E58680-LBL-45					
Ne	E58690-LBL-10	E58690-LBL-30	E58690-LBL-45	4x2W	-	220-240V (500mA)	470nm	>90
Gr	E58700-LBL-10	E58700-LBL-30	E58700-LBL-45					
Bw	E58710-LBL-10	E58710-LBL-30	E58710-LBL-45					

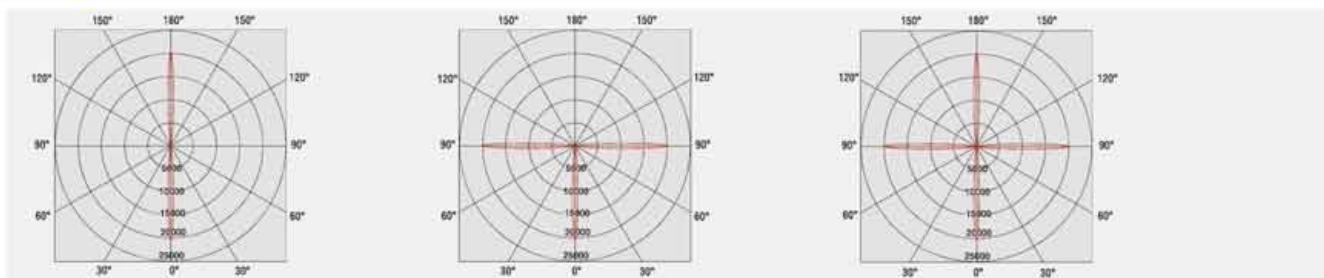
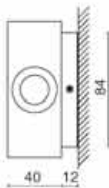

outside

ALIMENTATORI-KIT RGB (se non in dotazione) da ordinare dalla sezione arancio - DRIVERS-RGB KITS (when not supplied) to be ordered from the section orange color

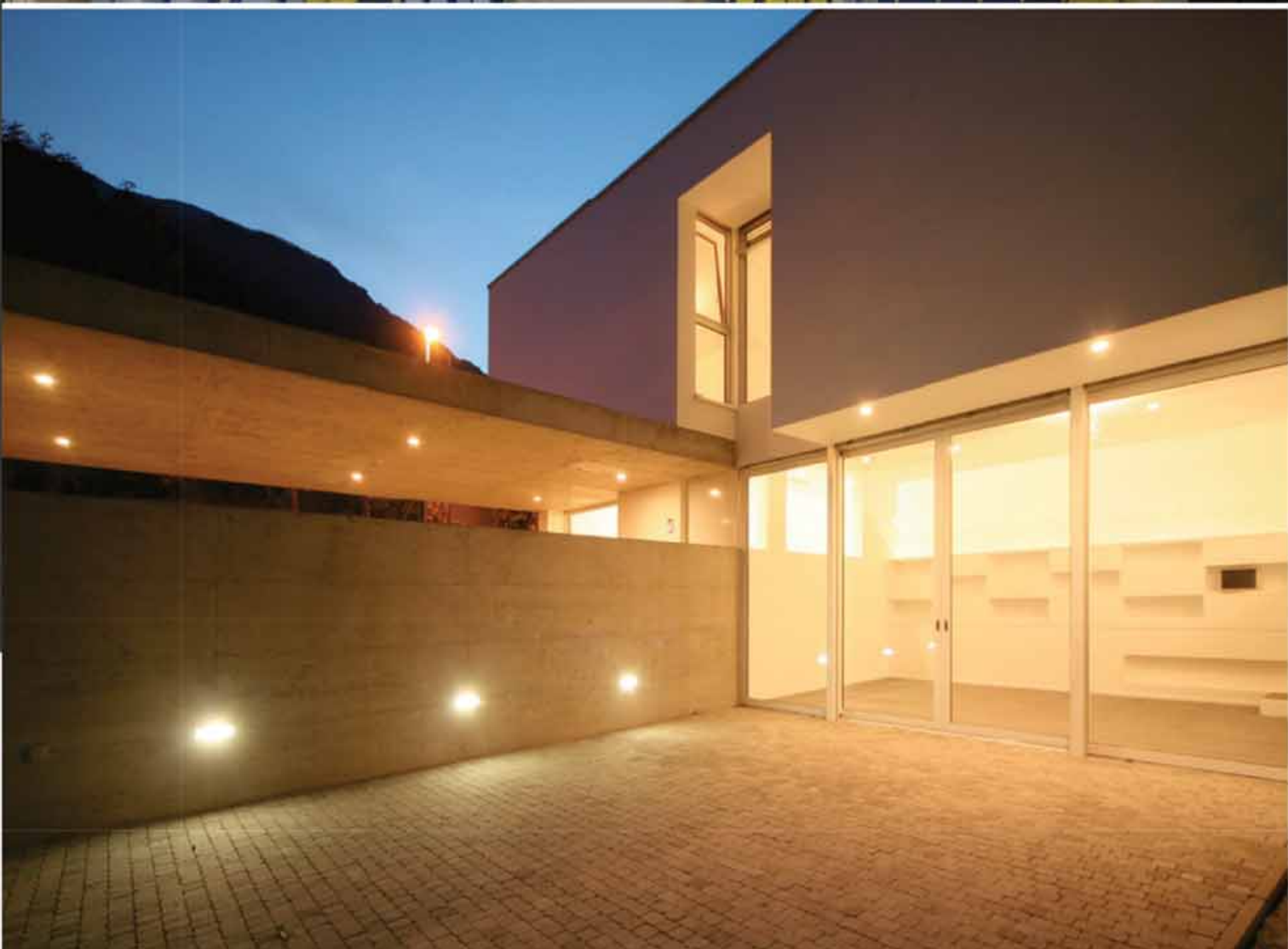



LI-LED



- Corpo in estruso di alluminio anodizzato.
 - Viti in acciaio Inox.
 - Guarnizioni in gomma silconica.
 - Vetro di protezione trasparente serigrafato spessore 8 mm.
 - Cavo di alimentazione 2x0,75 lunghezza 1 m.
 - Pressacavo in ottone nichelato PG7.
- Extruded aluminium body anodized.
 - Inox screws.
 - Silicon rubber gaskets.
 - Transparent glass protection with serigraphy thickness 8 mm.
 - Cable 2x0,75 length 1 m. supplied.
 - Cable gland of nickel plated brass PG7.

 128 37 125 41 80 0,45	Als E9053-LBC E9053-LBI E9053-LBL	1x3W 150 245 -	220-240V [350mA]	3000 6000 470nm	>80 57° - -					

*Solo apparecchio - Only fitting

Carico statico 500 kg
Static load 500 kg

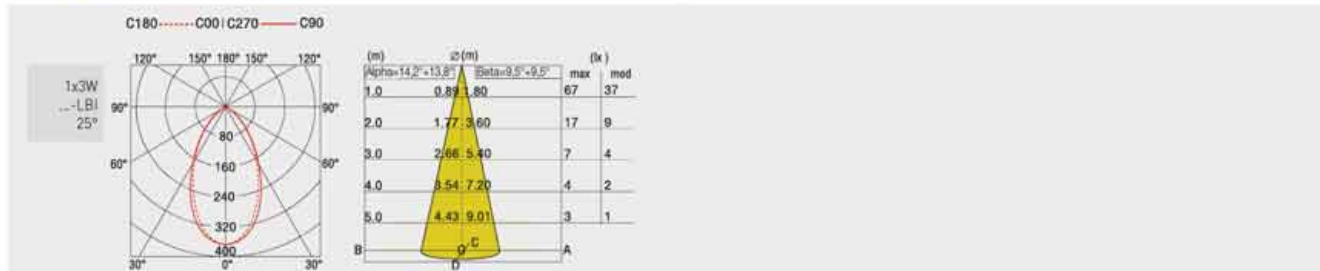

ALIMENTATORI-KIT RGB (se non in dotazione) da ordinare dalla sezione arancio - DRIVERS-RGB KITS (when not supplied) to be ordered from the section orange color





LI-LED ST



- Corpo in estruso di alluminio anodizzato nero.
 - Viti in acciaio Inox.
 - Guarnizioni in gomma siliconica.
 - Lente in PMMA.
 - Vetro di protezione trasparente serigrafato spessore 8 mm.
 - Pressacavo in ottone nichelato PG7.
 - Cavo di alimentazione 2x0,75 lunghezza 1 m.
- Extruded aluminium body anodized black.
 - Inox screws.
 - Silicon rubber gaskets.
 - PMMA lens.
 - Transparent glass protection with serigraphy thickness 8 mm.
 - Cable gland of nickel plated brass PG7.
 - Power cable 2x0,75 length 1 m.

	LED						SYSTEM-SYSTEM		
	W	lm	V	K	CRI	T	W	lm	W
	E9053-P-LBC E9053-P-LBI E9053-P-LBL								
	1x3W	150	220-240V	3000	>90	57°	4W	67	17
	-	245	[350mA]	6000	-	-	-	109	27

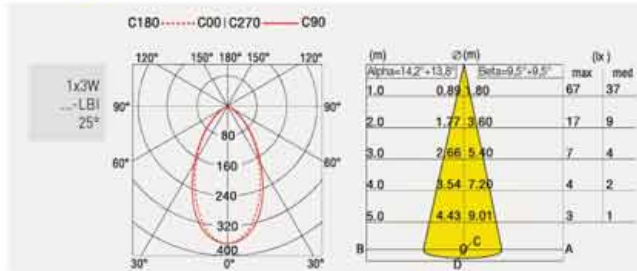

ALIMENTATORI-KIT RGB (se non in dotazione) da ordinare dalla sezione arancio - DRIVERS-RGB KITS (when not supplied) to be ordered from the section orange color





IMMERSIONE UNDERWATER

outside



MINI SUB

610



MINI TKF/TKT

614



PAR 56

617



SUBMARINER

620



SUBWATER

625







MINI SUB TKF

- Faro per fontana a 3 Led bianco.
- Consumo max: 8,4VA - 8W.
- Acciaio inox (AISI 316).
- Alimentazione 12Vac.
- Cavo lunghezza 4 m.
- Profondità d'installazione 3 m. max.

- White 3 Leds lamp for fountain.
- Max power consumption: 8,4VA - 8W.
- Inox steel (AISI 316).
- 12Vac power.
- 4 m. length cable.
- 3 m. max depth.



 Adatto per installazioni in acqua fino a 3 m. di profondità
Suitable for underwater applications max depth 3 m.

			(W)	(lm)	(V)	(K)	(CRI)
Inox E9604-LBI-30			10W	790	12Vac	5300	>80
Inox E9604-LBI-120			10W	790	12Vac	5300	>80

 100g

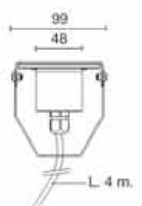
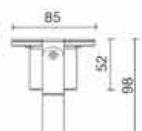

N.B. Apparecchio subacqueo per funzionamento solo in sommersione.
La temperatura dell'acqua non deve superare i 40°C.

N.B. Underwater fitting for underwater operation only.
The water temperature should not exceed 40° C.

ACC.	E101	Trasformatore 100VA - Transformer 100VA
	E102	Trasformatore 300VA - Transformer 300VA

IP 68



outside

MINI SUB COLOR TKT RGBW





- Lampada per fontana con sistema cambia colori RGBW a 4 Led a radio frequenza, con programmi preimpostati.
- Consumo max: 17VA - 15W.
- Acciaio inox (AISI 316).
- Alimentazione 12Vac.
- Cavo lunghezza 4 m.
- Profondità d'installazione 3 m. max.

- 4 Leds RGB colour changing projector for fountain with radio-frequence remote control pre-programmed effects.
- Max power consumption: 17VA - 15W.
- Inox steel (AISI 316).
- 12Vac power.
- 4 m. lenght cable.
- 3 m. max depth.

 Adatto per installazioni in acqua fino a 3 m. di profondità
Suitable for underwater applications max depth 3 m.

 Telecomando a radio frequenza - a richiesta cod. E100
Radio frequency remote control - on request code E100

			(W)	(lm)	(V)	(K)	
 1,00	Inox	E9608-RGB-30		15W	432	12Vac	
	Inox	E9608-RGB-120		15W	432	12Vac	
<p>N.B. Apparecchio subacqueo per funzionamento solo in sommersione. La temperatura dell'acqua non deve superare i 40°C.</p> <p>N.B. Underwater fitting for underwater operation only. The water temperature should not exceed 40° C.</p>							
ACC.	E100	Kit telecomando - Remote control kit					
	E101	Trasformatore 100VA - Transformer 100VA					
	E102	Trasformatore 300VA - Transformer 300VA					

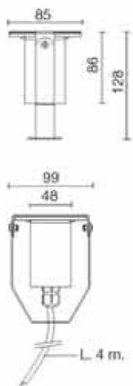

IP 68



ALIMENTATORI-KIT RGB (se non in dotazione) da ordinare dalla sezione arancio - DRIVERS-RGB KITS (when not supplied) to be ordered from the section orange color

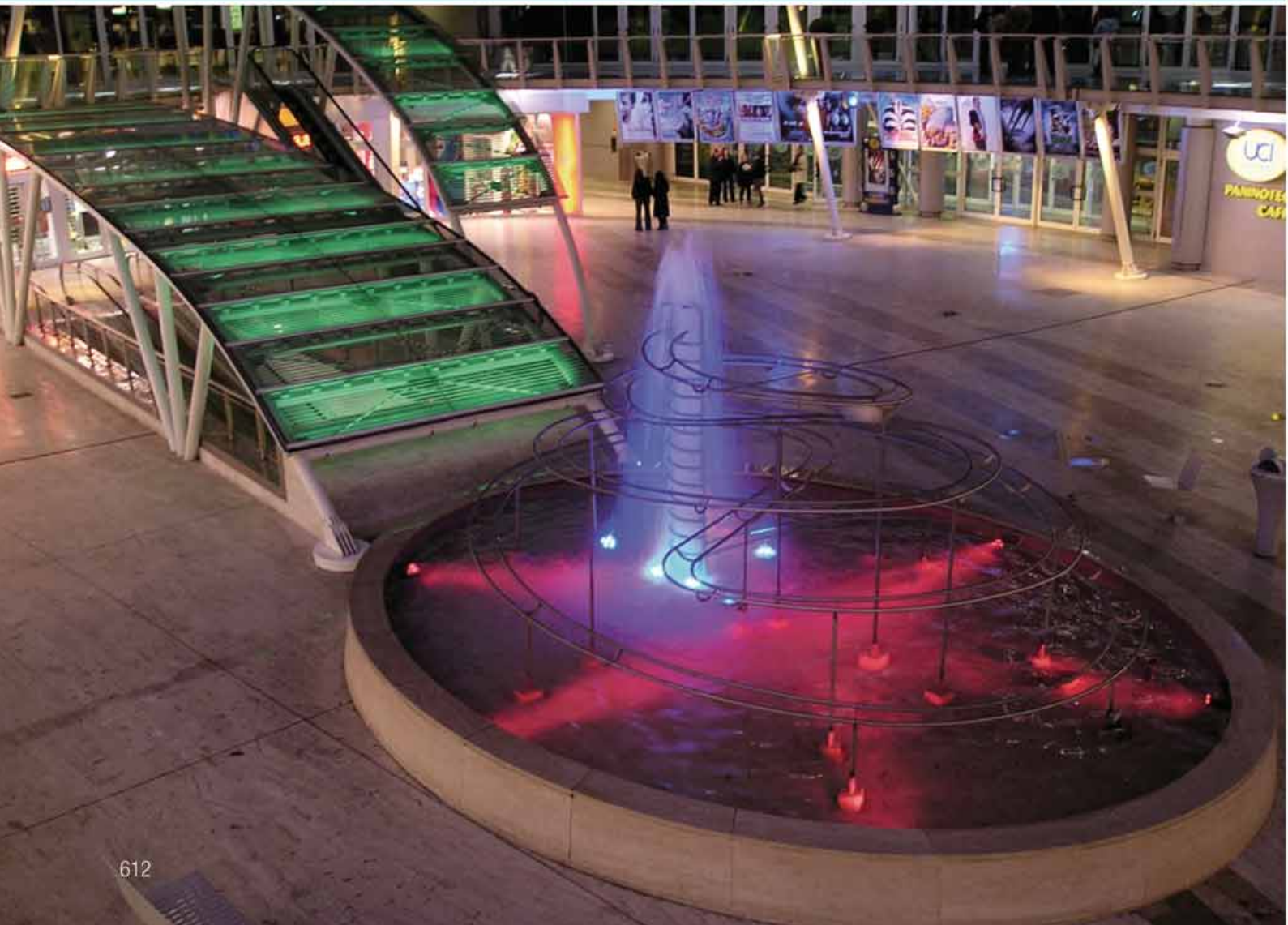

MINI SUB COLOR KIT IN RGBW



- Faro per fontana per incasso a pavimento, con sistema cambiachlori RGBW a 4 LED a radio frequenza, con programmi preimpostati.
- Acciaio inox (AISI 316).
- Alimentazione 12Vac.
- Consumo max: 17VA - 15W.
- Cavo lunghezza 4 m.
- Profondità d'installazione 3 m. max.

- 4 Leds RGB colour changing projector for fountain with radio-frequency remote control pre-programmed effects.
- Inox steel (AISI 316).
- Power 12Vac.
- Max power consumption: 17 VA - 15 W for underground installation.
- 4 m. lenght cable.
- 3 m. max depth.



Adatto per installazioni in acqua fino a 3 m. di profondità
Suitable for underwater applications max. depth 3 m.

Telecomando a radio frequenza - a richiesta cod. E100
Radio frequency remote control - on request code E100

	Inox E9601-RGB-30	15W	432	12Vac	
	Inox E9601-RGB-120	15W	432	12Vac	
<p>N.B. Apparecchio subacqueo per funzionamento solo in sommersione. La temperatura dell'acqua non deve superare i 40°C.</p> <p>N.B. Underwater fitting for underwater operation only. The water temperature should not exceed 40° C.</p>					

ACC.		
E100	Kit telecomando - Remote control kit	
E101	Trasformatore 100VA - Transformer 100VA	
E102	Trasformatore 300VA - Transformer 300VA	

IP 68



outside



MINI TKF M4-37W

- Lampada per fontana con 16 Led (4 multichip) bianca.
- Consumo max: 42VA - 37W.
- Acciaio inox (AISI 316).
- Alimentazione 12Vac.
- Cavo lunghezza 4 m.
- Profondità d'installazione 3 m. max.

- White 16 Leds (multichip) lamp for fountain.
- Max power consumption: 42VA - 37W.
- Inox steel (AISI 316).
- 12Vac power.
- 4 m. length cable.
- 3 m. max depth.



Adatto per installazioni in acqua fino a 3 m. di profondità
Suitable for underwater applications max depth 3 m.

			(W)	(lm)	(V)	(K)	(CRI)	
	Inox	E9603-LBI-21	21	37W	3880	12Vac	5300	>80
	Inox	E9603-LBI-45	45	37W	3880	12Vac	5300	>80
	Inox	E9603-LBI-65	65	37W	3880	12Vac	5300	>80
	Inox	E9603-LBI-120	120	37W	3880	12Vac	5300	>80
<p>N.B. Apparecchio subacqueo per funzionamento solo in sommersione. La temperatura dell'acqua non deve superare i 40°C.</p> <p>N.B. Underwater fitting for underwater operation only. The water temperature should not exceed 40° C.</p>								
<p>ACC. E101 Trasformatore 100VA - Transformer 100VA E102 Trasformatore 300VA - Transformer 300VA</p>								

IP 68





MINI COLOR TKT RGBW

- Lampada per fontana con sistema cambia colori RGBW a 12 Led, con programmi preimpostati.
- Consumo max: 29VA - 26W.
- Acciaio inox (AISI 316).
- Alimentazione 12Vac.
- Cavo lunghezza 4 m.
- Profondità d'installazione 3 m. max.

- 12 Leds RGBW colour changer projector with guided waves for fountain, pre-programmed effects.
- Max power consumption: 29VA - 26W.
- Inox steel (AISI 316).
- 12Vac power.
- 4 m. lenght cable.
- 3 m. max depth.



Adatto per installazioni in acqua fino a 3 m. di profondità
Suitable for underwater applications max depth 3 m.

Telecomando a radio frequenza - a richiesta cod. E100
Radio frequency remote control - on request code E100

			W	lm	V	K	
	Inox	E9607-RGB-15	15	26W	948	12Vac	
	Inox	E9607-RGB-35	35	26W	948	12Vac	
	Inox	E9607-RGB-80	80	26W	948	12Vac	
	Inox	E9607-RGB-120	120	26W	948	12Vac	
<p>N.B. Apparecchio subacqueo per funzionamento solo in sommersione. La temperatura dell'acqua non deve superare i 40°C.</p> <p>N.B. Underwater fitting for underwater operation only. The water temperature should not exceed 40° C.</p>							
ACC.	E100	Kit telecomando - Remote control kit					
	E101	Trasformatore 100VA - Transformer 100VA					
	E102	Trasformatore 300VA - Transformer 300VA					

IP 68



outside

ALIMENTATORI-KIT RGB (se non in dotazione) da ordinare dalla sezione arancio - DRIVERS-RGB KITS (when not supplied) to be ordered from the section orange color



PAR 56 TKF POWER



- Lampada per fontana a 36 Led bianca.
- Alimentazione 12 Vac.
- Consumo max: 70VA - 65W.
- Acciaio inox (AISI 316).
- Cavo lunghezza 4 m.
- Profondità d'installazione 3 m. max.

- White 36 Leds lamp for fountain.
- 12Vac power.
- Max power consumption: 70VA - 65W.
- Inox steel (AISI 316).
- 4 m. lenght cable.
- 3 m. max depth.

Adatto per installazioni in acqua fino a 3 m. di profondità
Suitable for underwater applications max depth 3 m.

			(W)	(lm)	(V)	(K)	(CRI)
Inox	E9602-LBI-15		65W	5040	12Vac	5300	>80
Inox	E9602-LBI-18		65W	5040	12Vac	5300	>80
Inox	E9602-LBI-80		65W	5040	12Vac	5300	>80
Inox	E9602-LBI-120		65W	5040	12Vac	5300	>80

N.B. Apparecchio subacqueo per funzionamento solo in sommersione.
La temperatura dell'acqua non deve superare i 40°C.

N.B. Underwater fitting for underwater operation only.
The water temperature should not exceed 40° C.

ACC. **E101** Trasformatore 100VA - Transformer 100VA
E102 Trasformatore 300VA - Transformer 300VA

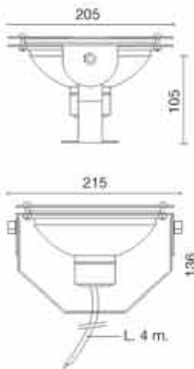

ALIMENTATORI-KIT RGB (se non in dotazione) da ordinare della sezione arancio - DRIVERS-RGB KITS (when not supplied) to be ordered from the section orange color



PAR 56 COLOR TKT RGBW POWER

- Lampada per fontana con sistema cambia colori RGBW a 36 Led, elettronica con programmi preimpostati.
 - Consumo max: 83VA - 73W.
 - Acciaio Inox (AISI 316).
 - Alimentazione 12Vac.
 - Cavo lunghezza 4 m.
 - Profondità d'installazione 3 m. max.
-
- 36 Leds RGBW color changer lamp for fountain, pre-programmed effects.
 - Max power consumption: 83VA - 73W.
 - Inox steel (AISI 316).
 - 12Vac power.
 - 4 m. length cable.
 - 3 m. max depth.



Adatto per installazioni in acqua fino a 3 m. di profondità
Suitable for underwater applications max depth 3 m.

Telecomando a radio frequenza - a richiesta cod. E100
Radio frequency remote control - on request code E100

			(W)	(lm)	(V)	(K)
	Inox	E9605-RGB-15	73W	2844	12Vac	
	Inox	E9605-RGB-18	73W	2844	12Vac	
	Inox	E9605-RGB-80	73W	2844	12Vac	
	Inox	E9605-RGB-120	73W	2844	12Vac	
<p>N.B. Apparecchio subacqueo per funzionamento solo in immersione. La temperatura dell'acqua non deve superare i 40°C.</p> <p>N.B. Underwater fitting for underwater operation only. The water temperature should not exceed 40° C.</p>						
ACC.	E100	Kit telecomando - Remote control kit				
	E101	Trasformatore 100VA - Transformer 100VA				
	E102	Trasformatore 300VA - Transformer 300VA				

IP 68



PAR 56 COLOR TKT RGBW PLUS



- Lampada per fontana con sistema cambia colori RGB a 24 Led, elettronica con programmi preimpostati.
- Consumo max: 58VA - 51W.
- Acciaio inox (AISI 316).
- Alimentazione 12Vac.
- Cavo lunghezza 4 m.
- Profondità d'installazione 3 m. max.

- 24 Leds RGB color changer lamp for fountain, pre-programmed effects.
- Max power consumption: 58VA - 51W.
- Inox steel (AISI 316).
- 12Vac power.
- 4 m. lenght cable.
- 3 m. max depth.

Adatto per installazioni in acqua fino a 3 m. di profondità
Suitable for underwater applications max depth 3 m.

Telecomando a radio frequenza - a richiesta cod. E100
Radio frequency remote control - on request code E100

			(W)	(Im)	(V)	(K)	
	Inox	E9606-RGB-15	15	51W	1896	12Vac	
	Inox	E9606-RGB-35	35	51W	1896	12Vac	
	Inox	E9606-RGB-80	80	51W	1896	12Vac	
	Inox	E9606-RGB-120	120	51W	1896	12Vac	

N.B. Apparecchio subacqueo per funzionamento solo in sommersione. La temperatura dell'acqua non deve superare i 40°C.
N.B. Underwater fitting for underwater operation only. The water temperature should not exceed 40° C.

- ACC.
- E100 Kit telecomando - Remote control kit
 - E101 Trasformatore 100VA - Transformer 100VA
 - E102 Trasformatore 300VA - Transformer 300VA

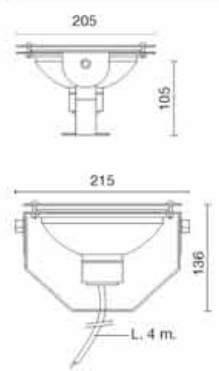

ALIMENTATORI-KIT RGB (se non in dotazione) da ordinare dalla sezione arancio - DRIVERS-RGB KITS (when not supplied) to be ordered from the section orange color



SUBMARINER 140



- Proiettore a tenuta stagna.
 - Corpo e staffa regolabile in acciaio inox anticorrosione (AISI 316) satinato e rivestito con layer di protezione contro l'aggressione della salsedine.
 - Vetro temperato ad alto spessore.
 - N.B. L'apparecchio non è adatto all'immersione in acqua marina.
- Waterproof floodlights.
 - Housing and adjustable bracket made of satin finished corrosion resistant stainless steel (AISI 316) and coated with a protective layer to prevent corrosion by salt in the air.
 - Extra thick, tempered glass.
 - N.B. The floodlight is not suitable for immersion in sea water.



Adatto per installazioni in acqua fino a 3 m. di profondità
Suitable for underwater applications max depth 3 m.

	LED	SISTEMA-SYSTEM						
		W	lm	lm/W				
	W	lm	V	K	CRI	W	lm	lm/W
Inox E8246-RGB	3x12W	-	350mA		-	-	-	-

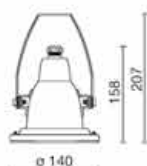

LED COB	LED	SISTEMA-SYSTEM							
		W	lm	lm/W					
	W	lm	V	K	△	CRI	W	lm	lm/W
Inox E8246C-LBC-15	12,3W	1040				>90	12,3W	885	72
Inox E8246C-LBC-24	12,9W	1430	12Vcd	3000		>80	12,9W	1245	97
Inox E8246C-LBC-40	12,9W	1360				>80	12,9W	1140	88
Inox E8246C-LBN-15	12,3W	1120				>90	12,3W	950	77
Inox E8246C-LBN-24	12,9W	1510	12Vcd	4000		>80	12,3W	1310	102
Inox E8246C-LBN-40	12,9W	1430				>80	12,3W	1219	94

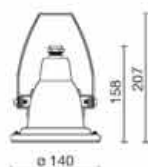

OP. Apparecchi forniti completi di vetro satinato - Fitting supplied complete with frosted glass

E...A Vetro satinato - Frosted glass

Apparecchi con griglia di protezione - Light fitting with protection grid



ALIMENTATORI-KIT RGB (se non in dotazione) da ordinare dalla sezione arancio - DRIVERS-RGB KITS (when not supplied) to be ordered from the section orange color

SUBMARINER 175



- Proiettore a tenuta stagna.
- Corpo e staffa regolabile in acciaio inox anticorrosione (AISI 316) satinato e rivestito con layer di protezione contro l'aggressione della salsedine.
- Vetro temperato ad alto spessore.
- N.B. L'apparecchio non è adatto all'immersione in acqua marina.
- Waterproof floodlights.
- Housing and adjustable bracket made of satin finished corrosion resistant stainless steel (AISI 316) and coated with a protective layer to prevent corrosion by salt in the air.
- Extra thick, tempered glass.
- N.B. The floodlight is not suitable for immersion in sea water.

Adatto per installazioni in acqua fino a 3 m. di profondità
Suitable for underwater applications max. depth 3 m.

		LED					SISTEMA-SYSTEM		
		W	lm	V	K	CRI	W	lm	lm/W
Inox	E8239-LBC-12	12W	1780	12Vdc	3000	>80	15W	1538	102
	E8239-LBN-12		1850					4000	1600
Inox	E8239-LBC-55	12W	1780	12Vdc	3000	>80	15W	1350	90
	E8239-LBN-55		1850					4000	1405
Inox	E8242-RGB	5x3,6W	-	350mA		-	-	-	-

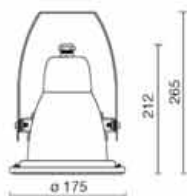

DP. Apparecchi forniti completi di vetro satinato - Fitting supplied complete with frosted glass
E...-A Vetro satinato - Frosted glass

Apparecchi con griglia di protezione - Light fitting with protection grid



ALIMENTATORI-KIT RGB (se non in dotazione) da ordinare dalla sezione arancio - DRIVERS-RGB KITS (when not supplied) to be ordered from the section orange color





SUBMARINER 240



- Proiettore a tenuta stagna.
 - Corpo e staffa regolabile in acciaio inox anticorrosione (AISI 316) satinato e rivestito con layer di protezione contro l'aggressione della salsedine.
 - Vetro temperato ad alto spessore.
 - N.B. L'apparecchio non è adatto all'immersione in acqua marina.
-
- Waterproof floodlights.
 - Housing and adjustable bracket made of satin finished corrosion resistant stainless steel (AISI 316) and coated with a protective layer to prevent corrosion by salt in the air.
 - Extra thick, tempered glass.
 - N.B. The floodlight is not suitable for immersion in sea water.

Adatto per installazioni in acqua fino a 3 m. di profondità
 Suitable for underwater applications max depth 3 m.

		LED					SISTEMA-SYSTEM		
		W	lm	V	K	CRI	W	lm	lm/W
E8249-LBC E8249-LBN	Inox	12W	1780 1850	12Vdc	3000 4000	>80	15W	1602 1660	107 110
	Inox	15x1,2W	-	350mA		-	-	-	-



55

T

3,60

55

DP: Apparecchi forniti completi di vetro satinato - Fitting supplied complete with frosted glass
 E...-A Vetro satinato - Frosted glass





Apparecchi con griglia di protezione - Light fitting with protection grid



ALIMENTATORI-KIT RGB (se non in dotazione) da ordinare dalla sezione arancio - DRIVERS-RGB KITS (when not supplied) to be ordered from the section orange color





IP 68         

ALIMENTATORI-KIT RGB (se non in dotazione) da ordinare dalla sezione arancio - DRIVERS-RGB KITS (when not supplied) to be ordered from the section orange color

**SUBWATER 140**

LED COB



- Adatto per illuminazione di vasche, fontane, piscine.
 - Profondità di installazione 3 m. max.
 - Cavo di alimentazione lunghezza 5 m. collegato.
 - Manutenzione senza svuotamento della vasca.
 - Corpo e cassaforma in acciaio Inox anticorrosione (AISI 316) satinato e rivestito con layer di protezione contro l'ossidazione.
 - Vetro temperato ad alto spessore.
 - N.B. L'apparecchio non è adatto all'immersione in acqua marina.
- Suitable for pools, fountain, tanks.
 - Installation depth max 3 m.
 - Power cable length 5 m. connected.
 - Maintenance without emptying the water.
 - Body and housing made of satin finished corrosion resistant stainless steel (AISI 316) and coated with a protective layer to prevent corrosion by oxidation.
 - Extra thick, tempered glass.
 - N.B. The fitting is not suitable for immersion in sea water.

Adatto per installazioni in acqua fino a 10 m. di profondità
Suitable for underwater applications max depth 10 m.

	LED	SISTEMA-SYSTEM		
		W	lm	W
	W Im V K CRI	W	lm	W
	3x1,2W - 350mA	-	-	-

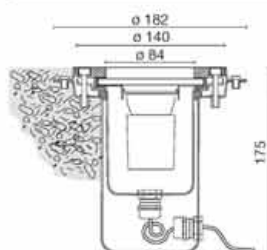

Esempio di installazione in vasche con guaina in PVC
Example of installation in tanks with PVC sheath

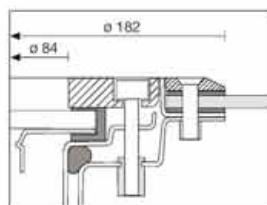

LED COB	LED	SISTEMA-SYSTEM		
		W	lm	W
	W Im V K CRI T	W	lm	W
Inox E8253C-LBC-15	12,3W 1040	14,3W	896	62
Inox E8253C-LBC-24	12,9W 1430	14,9W	1207	81
Inox E8253C-LBC-40	12,9W 1340	14,9W	1136	76
	W Im V K CRI T	W	lm	W
Inox E8253C-LBN-15	12,3W 1120	14,3W	965	67
Inox E8253C-LBN-24	12,9W 1510	14,9W	1274	86
Inox E8253C-LBN-40	12,9W 1430	14,9W	1194	80

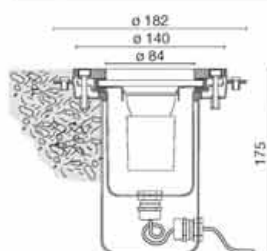

Esempio di installazione in vasche con guaina in PVC
Example of installation in tanks with PVC sheath

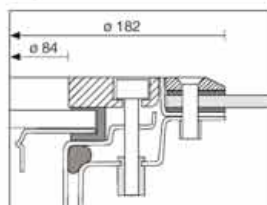

ACC. **E8261** Flangia per vasche con guaina in PVC
Flange for tanks with PVC sheath

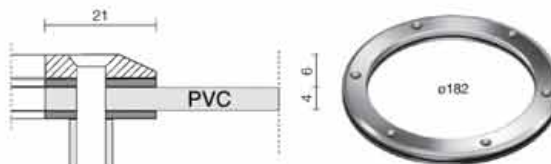





SUBWATER 175

- Adatto per illuminazione di vasche, fontane, piscine.
 - Profondità di installazione 3 m. max.
 - Cavo di alimentazione lunghezza 5 m. collegato.
 - Manutenzione senza svuotamento della vasca.
 - Corpo e cassaforma in acciaio Inox anticorrosione (AISI 316) satinato e rivestito con layer di protezione contro l'ossidazione.
 - Vetro temperato ad alto spessore.
 - N.B. L'apparecchio non è adatto all'immersione in acqua marina.
-
- Suitable for pools, fountain, tanks.
 - Installation depth max 3 m.
 - Power cable length 5 m. connected.
 - Maintenance without emptying the water.
 - Body and housing made of satin finished corrosion resistant stainless steel (AISI 316) and coated with a protective layer to prevent corrosion by oxidation.
 - Extra thick, tempered glass.
 - N.B. The fitting is not suitable for immersion in sea water.

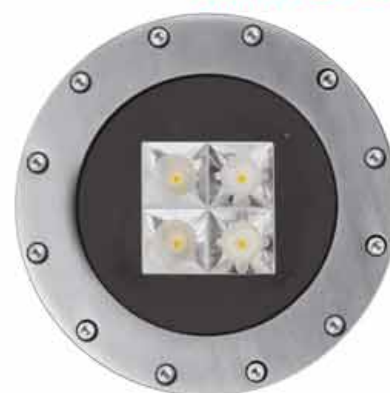

Adatto per installazioni in acqua fino a 3 m. di profondità
Suitable for underwater applications max depth 3 m.

	LED					SISTEMA-SYSTEM		
	W	lm	V	K	CRI	W	lm	lm/W
Inox E8263-LBC-12 E8263-LBN-12	12W	1780 1850	12Vdc	3000 4000	>80	15W	1538 1600	102 107
Inox E8263-LBC-55 E8263-LBN-55	12W	1780 1850	12Vdc	3000 4000	>80	15W	1350 1405	90 94
Inox E8254-RGB	5x3,6W	-	350mA		-	-	-	-

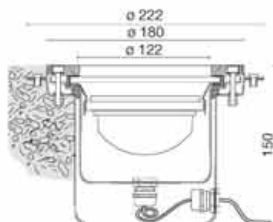

Esempio di installazione in vasche con guaina in PVC
Example of installation in tanks with PVC sheath

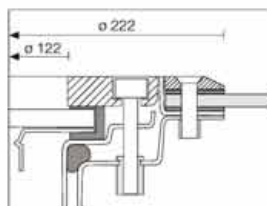

ACC. **E8262** Flangia per vasche con guaina in PVC
Flange for tanks with PVC sheath

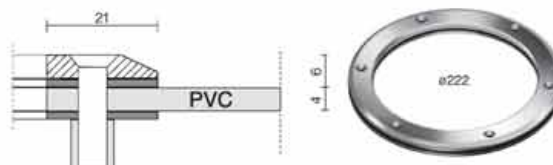

ALIMENTATORI-KIT RGB (se non in dotazione) da ordinare dalla sezione arancio - DRIVERS-RGB KITS (when not supplied) to be ordered from the section orange color

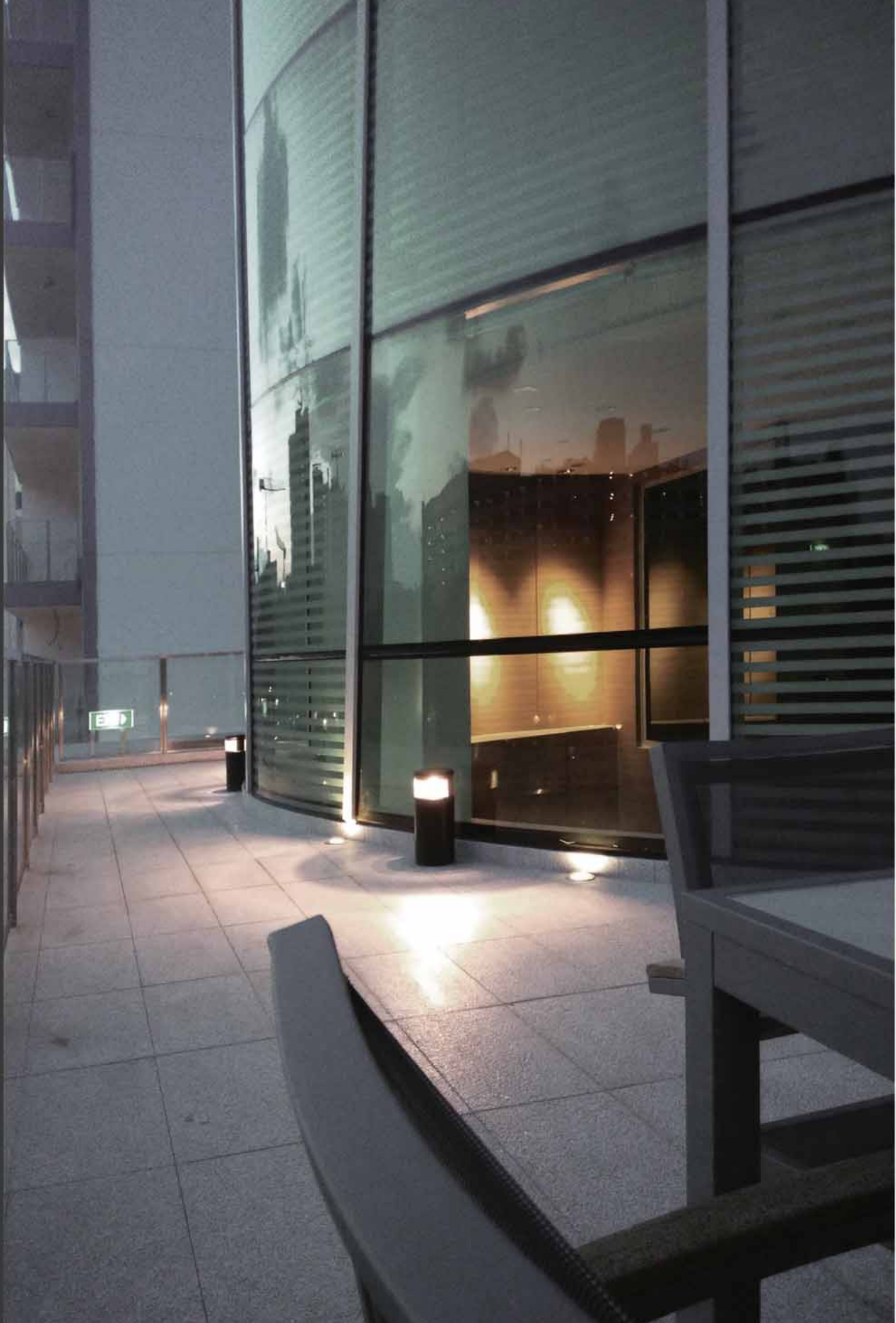



RESIDENZIALE URBANO - BOLLARDS URBAN & RESIDENTIAL LUMINAIRES - BOLLARDS

outside

• PALI - POST



TESTA PALO
SINGOLO
630



TESTA PALO
DOPPIO
631



ATTACCO PALO
632



ATTACCO PALO
DOPPIO
633



PALO QUADRO
635

• BOLLARDS



LITTLE ROK
637



ROK
639



Q8
641

NEW



VERSO
643



FRISBEE
647



FRISBEE MAXI
649



ELLE
651

Anticorrosione per tutti gli apparecchi da esterno [1000 ore in nebbia salina secondo norma CEI EN 60068-2-11]
Anti-corrosion for all outdoor fittings [1000 hours in salt spray according to standard CEI EN 60068-2-11]





TESTA PALO SINGOLO - SINGLE POLE HEAD

- Testa-palo Ø 60 mm per apparecchio singolo.
- Corpo e staffa di ancoraggio in alluminio pressofuso.
- Verniciatura in polveri con pretrattamento speciale per esterni.
- Viteria in acciaio Inox.
- N.B.: da ordinare unitamente all'apparecchio.

- Pole head Ø 60 mm for single fixture.
- Body and hanging bracket in die-cast aluminium.
- Powder coated with pre-treatment for outdoor use.
- Inox steel screws.
- Note: to be ordered with the fitting.

Per pali Ø 60 mm - For pole Ø 60 mm



TESTA PALO PER APPARECCHIO SINGOLO - POLE HEAD FOR SINGLE FIXTURE

Br E8755
Ne E8756
Gr E8757

1,70 kg

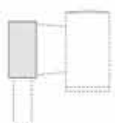

Ø 60

ESEMPIO ORDINAZIONE - ORDER EXAMPLING

1 Apparecchio Monolight + 1 Testa palo Ø 60 mm
1 Monolight fixtures + 1 Pole head Ø 60 mm =



Adatto per - Available for:



MONOLIGHT
175



DOUBLELIGHT
175



QUADRO MONO
MCL



QUADRO
DOUBLE

**TESTA PALO DOPPIO - DOUBLE POLE HEAD**

Per pali Ø 60 mm - For pole Ø 60 mm

- Testa-palo Ø 60 mm per apparecchio doppio.
- Corpo e staffa di ancoraggio in alluminio pressofuso.
- Verniciatura in polveri con pretrattamento speciale per esterni.
- Viteria in acciaio Inox.
- N.B.: da ordinare unitamente all'apparecchio.

- Pole head Ø 60 mm for single or double fixture.
- Body and hanging bracket in die-cast aluminium.
- Powder coated with pre-treatment for outdoor use.
- Inox steel screws.
- Note: to be ordered with the fitting.



TESTA PALO PER APPARECCHIO DOPPIO - POLE HEAD FOR DOUBLE FIXTURE

Br	E8758
Ne	E8759
Gr	E8760

Esempio ordinazione - Order exampling

2 Apparecchi Doublelight	+	1 Testa palo Ø 60 mm	=	
2 Doublelight fixtures		1 Pole head Ø 60 mm		

Adatto per - Available for:

**MONOLIGHT**
175**DOUBLELIGHT**
175**QUADRO MONO**
MCL**QUADRO**
DOUBLE



Ø 60 mm - Ø 120 mm

ATTACCO PALO SINGOLO - ADAPTUR SINGLE POLE

- Corpo e staffa di ancoraggio in alluminio pressofuso.
- Verniciatura in polveri con pretrattamento speciale per esterni.
- Viteria in acciaio Inox.
- N.B.: da ordinare unitamente all'apparecchio.

- Body and hanging bracket in die-cast aluminium.
- Powder coated with pre-treatment for outdoor use.
- Inox steel screws.
- Note: to be ordered with the fixture.

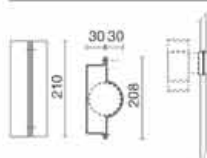

ATTACCO PER PALO Ø 60 mm - POLE BRACKET Ø 60 mm

Bl E5191
Ne E5192
Gr E5193

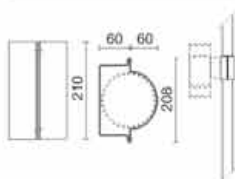

ATTACCO PER PALO Ø 120 mm - POLE BRACKET Ø 120 mm

Bl E5195
Ne E5196
Gr E5197

Esempio ordinazione - Order exempling

1 Apparecchio + 1 Attacco per palo Ø 60 o Ø 120 mm
1 Fixture + 1 Pole bracket Ø 60 or Ø 120 mm



Adatto per - Available for:



MONOLIGHT
175



DOUBLELIGHT
175



QUADRO
MONO MCL



QUADRO
DOUBLE

**ATTACCO PALO DOPPIO - ADAPTUR DOUBLE POLE**

Ø 60 mm - Ø 120 mm

- Corpo e staffa di ancoraggio in alluminio pressofuso.
- Verniciatura in polveri con pretrattamento speciale per esterni.
- Viteria in acciaio Inox.
- N.B.: da ordinare unitamente all'apparecchio.

- Body and hanging bracket in die-cast aluminium.
- Powder coated with pre-treatment for outdoor use.
- Inox steel screws.
- Note: to be ordered with the fixture.

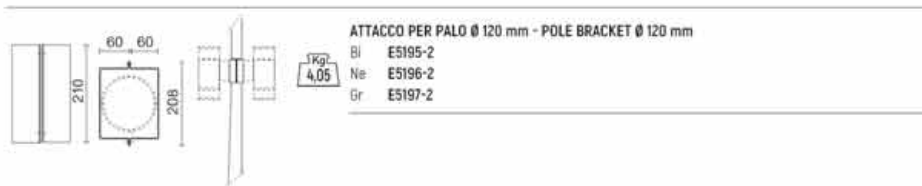

Esempio ordinazione - Order exampling

2 Apparecchi + 1 Attacco per palo Ø 60 o Ø 120 mm
 2 Fixtures + 1 Pole bracket Ø 60 or Ø 120 mm

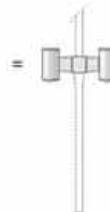

Adatto per - Available for:

**MONOLIGHT
175****DOUBLELIGHT
175****QUADRO
MONO MCL****QUADRO
DOUBLE**



**PALO QUADRO - SQUARE POLE**Palo \square 100 mm - Pole \square 100 mm

- Palo per apparecchio singolo.
- Corpo e staffa di ancoraggio in alluminio pressofuso.
- Verniciatura in polveri con pretrattamento speciale per esterni.
- Viteria in acciaio inox.
- N.B.: da ordinare unitamente all'apparecchio.

- Pole head for single fixture.
- Body and hanging bracket in die-cast aluminium.
- Powder coated with pre-treatment for outdoor use.
- Inox steel screws.
- Note: to be ordered with the fixture.

5kg
27**PALO H 3 m - POLE H 3 m**

Ne E4056-3



Esempio ordinazione - Order exempling

1 Apparecchio Quadro Mono + E4056-3 =

1 Quadro Mono fixture

5kg
54**PALO H 6 m - POLE H 6 m**

Ne E4056-6

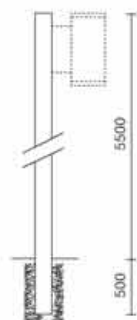

Esempio ordinazione - Order exempling

1 Apparecchio Quadro Mono + E4056-6 =

1 Quadro Mono fixture



100 mm

OP. A richiesta colorazioni bianco - grigio - On request colour white - grey



N.B. da ordinare unitamente all'apparecchio; specificare il n. apparecchi.
Il palo è predisposto solo per n. 1 apparecchio. A richiesta per max. 2 pz. (solo per lati opposti)

Note: to be ordered with the fixture; specify the n. of fittings.
The pole is studied only for n. 1 fitting. On request for max 2 pcs. (only for opposite side)

Adatto per - Available for:

**QUADRO
MONO****DUNE**

Adatto per tutte le versioni Quadro Mono tranne Quadro Mono MCL.
Suitable for all version Quadro Mono not for Quadro Mono MCL.





- Corpo: costituito da elementi in alluminio verniciati in polvere con pretrattamento speciale per esterni.
 - Settori di copertura del vetro per mono emissione.
 - Guarnizioni: gomma siliconica.
 - Montaggio tramite viti su materiali concreti. Pozzetto con piastra di raccordo per montaggio sulle superfici friabili.
 - Doppio pressacavo in ottone nichelato PG13,5.
- Housing: consists of elements made of aluminium, painted with special pre-treatment for outdoor use.
 - Covering glass sectors for mono emission.
 - Gasket: silicone rubber.
 - Installation by means of screws on concrete material. External housing with connection plate for installation on fragile surfaces.
 - PG13,5 double nichel brass cable gland.

	LED	LED					SISTEMA-SYSTEM		
		W	lm	V	K	CRI	W	lm	lm/W
		MONODIREZIONALE UNIDIRECTIONAL							
		Ne E8468-LBC	26,8W	2400	220-240V [600mA]	3000	>90	30,8W	361
	Gr E8469-LBC								
	Ne E8468-LBN	26,8W	2500	220-240V [600mA]	4000	>90	30,8W	379	12
	Gr E8469-LBN								
	Ne E8468-LBI	26,8W	2540	220-240V [600mA]	5000	>90	30,8W	384	13
Gr E8469-LBI									
		OMNIDIREZIONALE OMNIDIRECTIONAL							
		Ne E8470-LBC	26,8W	2400	220-240V [600mA]	3000	>90	30,8W	723
	Gr E8471-LBC								
	Ne E8470-LBN	26,8W	2500	220-240V [600mA]	4000	>90	30,8W	752	24
	Gr E8471-LBN								
	Ne E8470-LBI	26,8W	2540	220-240V [600mA]	5000	>90	30,8W	763	25
Gr E8471-LBI									



ACC. 898 Pozzetto per fissaggio interrato
Pit for ground attachment

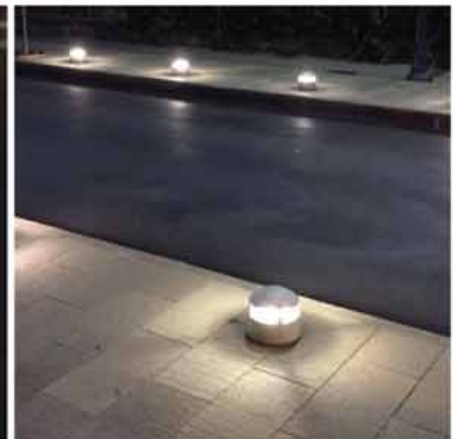

outside

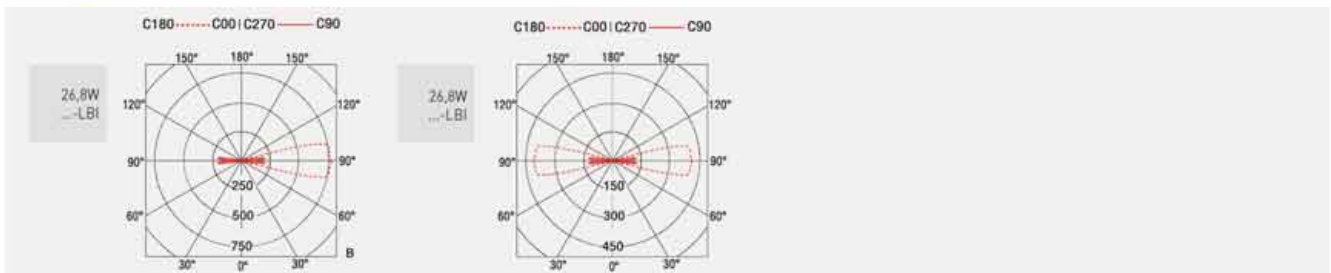

ALIMENTATORI-KIT RGB (se non in dotazione) da ordinare dalla sezione arancio - DRIVERS-RGB KITS (when not supplied) to be ordered from the section orange color





- Corpo: costituito da quattro elementi in alluminio verniciati in polvere con pretrattamento speciale per esterni.
- Settori di copertura del vetro per emissioni bi ed omnidirezionali.
- Guarnizioni: gomma siliconica.
- Montaggio: tramite piastra inox di fissaggio a quattro viti su materiali concreti. Pozzetto con raccordo per montaggio sulle superfici friabili.
- Doppio pressacavo in ottone nichelato PG13,5.

- Housing: consists of four aluminium elements, painted after special pre-treatment for outdoor use.
- Covering glass sectors for bi and omnidirectional emissions.
- Gasket: silicone rubber
- Installation: by means of a fixing inox plate with 4 screws on concrete material. External housing with connection plate for installation on fragile surfaces.
- PG13,5 double nichel brass cable gland.

	LED	LED					SISTEMA-SYSTEM			
		W	lm	V	K	CRI	W	lm	W	
		MONODIREZIONALE UNIDIRECTIONAL								
		Ne E8404-LBC	26,8W	2400	220-240V	3000	>90	30,8W	340	11
		Gr E8405-LBC			[600mA]					
		Ne E8404-LBN	26,8W	2500	220-240V	4000	>90	30,8W	354	11
		Gr E8405-LBN			[600mA]					
		Ne E8404-LBI	26,8W	2540	220-240V	5000	>90	30,8W	359	12
Gr E8405-LBI			[600mA]							
		BIDIREZIONALE BIDIRECTIONAL								
		Ne E8406-LBC	26,8W	2400	220-240V	3000	>90	30,8W	636	21
		Gr E8407-LBC			[600mA]					
		Ne E8406-LBN	26,8W	2500	220-240V	4000	>90	30,8W	662	22
		Gr E8407-LBN			[600mA]					
		Ne E8406-LBI	26,8W	2540	220-240V	5000	>90	30,8W	672	22
Gr E8407-LBI			[600mA]							
		OMNIDIREZIONALE OMNIDIRECTIONAL								
		Ne E8408-LBC	26,8W	2400	220-240V	3000	>90	30,8W	636	21
		Gr E8409-LBC			[600mA]					
		Ne E8408-LBN	26,8W	2500	220-240V	4000	>90	30,8W	662	22
		Gr E8409-LBN			[600mA]					
		Ne E8408-LBI	26,8W	2540	220-240V	5000	>90	30,8W	672	22
Gr E8409-LBI			[600mA]							



ACC. 646308 Connettore IP68 ø da 7 a 12mm - IP68 connector ø from 7 to 12mm



PER FISSAGGIO INTERRATO - FOR BURIED INSTALLATION
898 Pozzetto per fissaggio interrato - Pit for ground attachment
880 Pozzetto - Piastra per torretta - Housing - Plate for turret

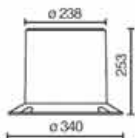

PER FISSAGGIO A PAVIMENTO - FOR FLOOR INSTALLATION
Ne 888 Torretta - Turret
Gr 889

IP 67
IK 06



outside

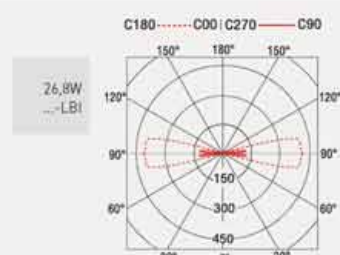
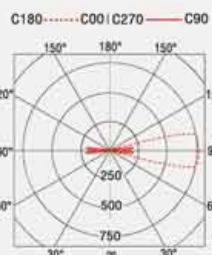

ALIMENTATORI-KIT RGB (se non in dotazione) da ordinare dalla sezione arancio - DRIVERS-RGB KITS (when not supplied) to be ordered from the section orange color

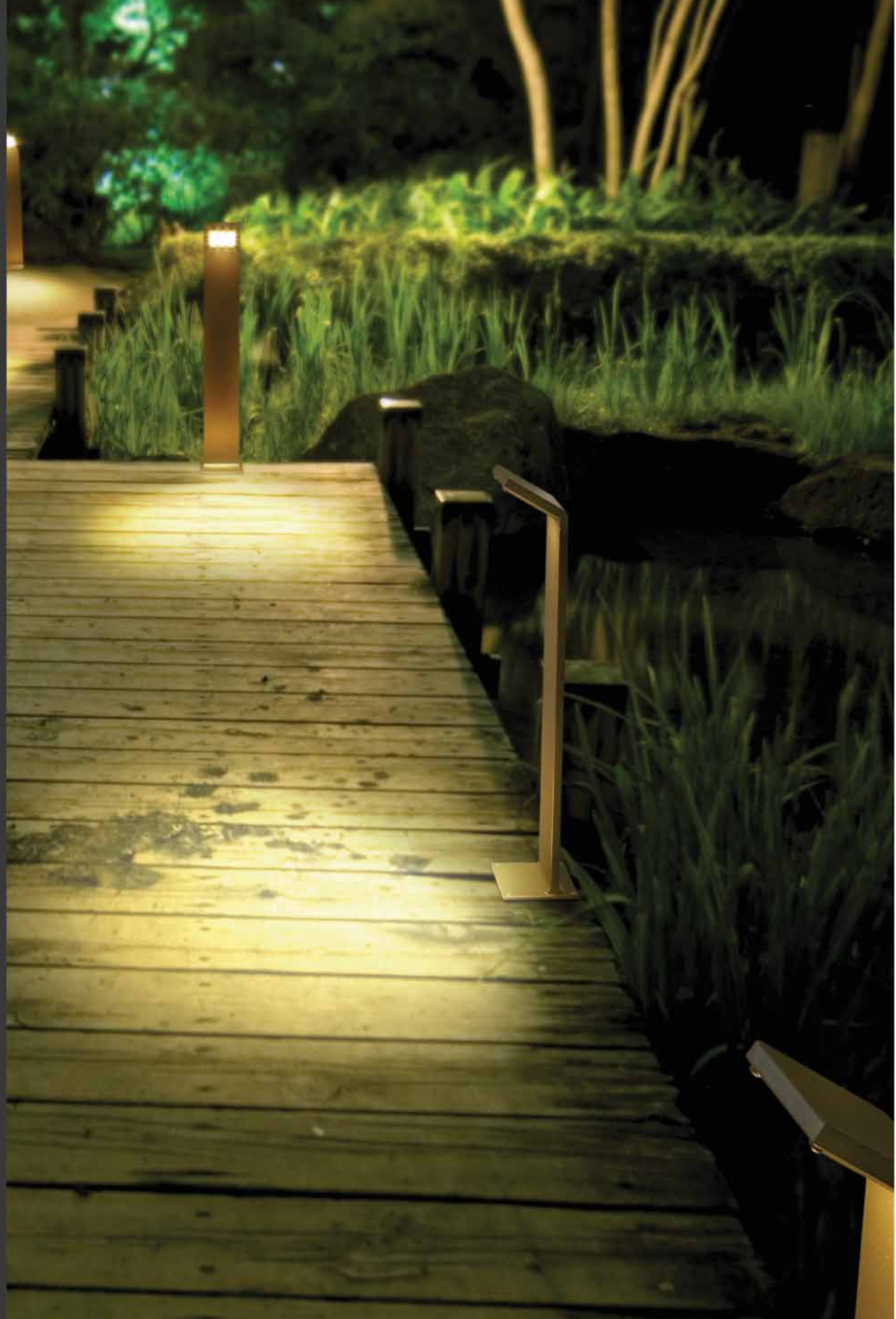



Q8

- Proiettore in pressofusione di alluminio, verniciato in polveri con pretrattamento speciale per esterni. In alternativa cromato.
- Base in acciaio Inox (AISI 316L).
- Guarnizione in silicone.
- Gruppo di alimentazione incorporato.

- Cast aluminium projector, powder coated with pre-treatment for outdoor use. Alternatively chrome.
- Base in stainless steel (AISI 316L).
- Silicon gasket.
- Built-in power supply unit.



		L (mm)	W	lm	V	K	CR0
	Bw D2040	400 mm	9x1,2W	950	220-240V (500mA)	3000	>90
	Bw D2041	700 mm	9x1,2W	950	220-240V (500mA)	3000	>90

	Bw D2040-P	400 mm	9x1,2W	580	220-240V (350mA)	3000	>90
	Bw D2041-P	700 mm	9x1,2W	580	220-240V (350mA)	3000	>90

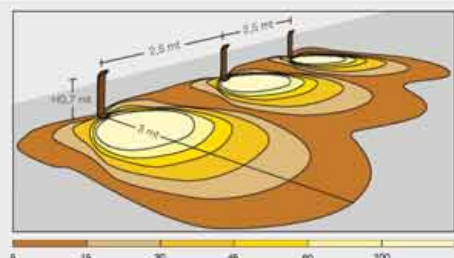
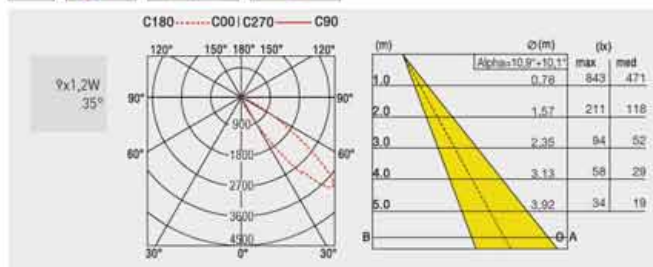
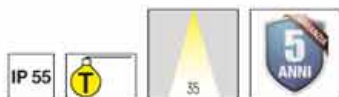

outside

ALIMENTATORI-KIT RGB (se non in dotazione) da ordinare dalla sezione arancio - DRIVERS-RGB KITS (when not supplied) to be ordered from the section orange color





- Corpo in estruso di alluminio lavorato.
 - Verniciatura in polveri di poliestere con trattamento speciale per esterni.
 - Schermo in policarbonato trasparente stabilizzato ai raggi UV.
 - Guarnizioni in gomma silconica.
 - Cavo alimentazione.
 - Pressacavo PG 7 in ottone nichelato.
 - Led durata utile: 50.000 (h) L90 B50.
 - Costanza cromatica: 3 SDCM.
- Extruded aluminum body.
 - Polyester powder painting with special treatment for outdoor.
 - UV-stabilized transparent polycarbonate screen.
 - Silicone rubber seals.
 - Power cable.
 - PG 7 cable gland in nickel-plated brass.
 - LED Life: 50.000 (h) L90 B50.
 - Chromatic constancy: 3 SDCM.



Ø 90

			LED					SISTEMA-SYSTEM		
	W	lm	V	K	CRI	W	lm	RA		
OMNIDIREZIONALE - OMNIDIRECTIONAL										
Br	LBC	E5911	9W	1520	220-240V (500mA)	3000	>90	11W	1050	95
Ne	BC	E5911								
GrA	LBC	E5912								
Bw	E5903-LBC	E5913-LBC								
MONODIREZIONALE - UNIDIRECTIONAL										
Br	LBN	E5911	9W	1640	220-240V (500mA)	4000	>90	11W	1150	104
Ne	BN	E5911								
GrA	BN	E5912								
Bw	E5903-LBN	E5913-LBN								
MONODIREZIONALE - UNIDIRECTIONAL										
Br	E5905-LBC	E5915-LBC	9W	1520	220-240V (500mA)	3000	>90	11W	760	70
Ne	E5906-LBC	E5916-LBC								
GrA	E5907-LBC	E5917-LBC								
Bw	E5908-LBC	E5918-LBC								
MONODIREZIONALE - UNIDIRECTIONAL										
Br	E5905-LBN	E5915-LBN	9W	1640	220-240V (500mA)	4000	>90	11W	820	74
Ne	E5906-LBN	E5916-LBN								
GrA	E5907-LBN	E5917-LBN								
Bw	E5908-LBN	E5918-LBN								

- ACC.**
- 3127** Anello in acciaio inox AISI 316 L per copertura base Ø 160 mm.
AISI 316 L stainless steel ring for base cover Ø 160 mm.
 - 894** Pozzetto per fissaggio a terra - Pit for ground fixing
 - 646308** Connettore IP68 Ø da 7 a 10mm
IP68 connector Ø from 7 to 10mm
 - 646636** Connettore IP68 a "T" Ø da 7 a 10mm per file continue
T-shaped IP68 connector to Ø from 7 to 10mm for continuous line
 - 4073** Piastra tirafondi in acciaio zincato
Galvanized steel fixing plate with anchor belts

OP. A richiesta - On request: sensore di movimento PIR - motion sensor PIR

IP 65
IK 10



outside

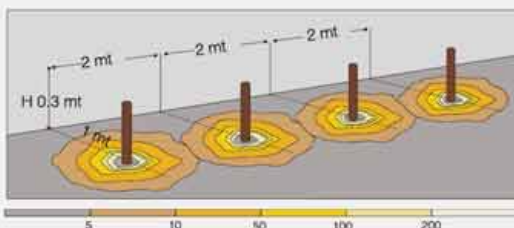

VERSO 90

ALIMENTATORI-KIT RGB (se non in dotazione) da ordinare dalla sezione arancio - DRIVERS-RGB KITS (when not supplied) to be ordered from the section orange color





- Corpo in estruso di alluminio lavorato.
- Verniciatura in polveri di poliestere con trattamento speciale per esterni.
- Schermo in policarbonato trasparente stabilizzato ai raggi UV.
- Guarnizioni in gomma siliconica.
- Cavo alimentazione.
- Pressacavo PG 13,5 in ottone nichelato.
- Led durata utile: 50.000 (h) L90 B50.
- Costanza cromatica: 3 SDCM.

- Extruded aluminum body.
- Polyester powder painting with special treatment for outdoor.
- UV-stabilized transparent polycarbonate screen.
- Silicone rubber seals.
- Power cable.
- PG 13,5 cable gland in nickel-plated brass.
- LED Life: 50.000 (h) L90 B50.
- Chromatic constancy: 3 SDCM.

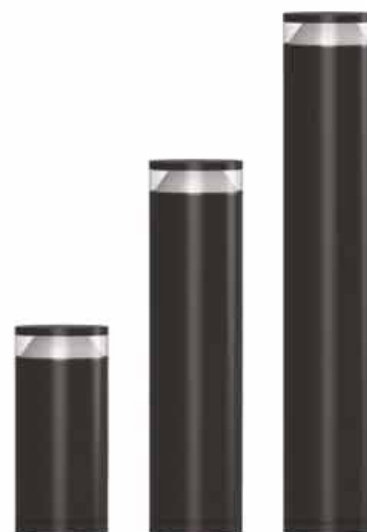

ø 175

			LED					SISTEMA-SYSTEM			
			W	lm	V	K	CRI	W	lm	lm/W	
OMNIDIREZIONALE - OMNIDIRECTIONAL											
Br	E5920-LBC	E5925-LBC	E5930-LBC								
Ne	E5921-LBC	E5926-LBC	E5931-LBC	16W	2750	220-240V (500mA)	3000	>90	20W	1900	95
GrA	E5922-LBC	E5927-LBC	E5932-LBC								
Bw	E5923-LBC	E5928-LBC	E5933-LBC								
MONODIREZIONALE - UNIDIRECTIONAL											
Br	E5940-LBC	E5945-LBC	E5950-LBC								
Ne	E5941-LBC	E5946-LBC	E5951-LBC	16W	2750	220-240V (500mA)	3000	>90	20W	1370	68
GrA	E5942-LBC	E5947-LBC	E5952-LBC								
Bw	E5943-LBC	E5948-LBC	E5953-LBC								
ACC.											
899	Pozzetto per fissaggio a terra - Pit for ground fixing										
646308	Connettore IP68 ø da 7 a 12mm IP68 connector ø from 7 to 12mm										
646636	Connettore IP68 a "T" ø da 7 a 10mm per file continue T-shaped IP68 connector to ø from 7 to 10mm for continuous line										
4074	Piastra tirafondi in acciaio zincato Galvanized steel fixing plate with anchor belts										



H=400mm	4,00
H=700mm	6,00
H=1000mm	8,00

OP. A richiesta - On request: sensore di movimento PIR - motion sensor PIR

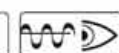

outside

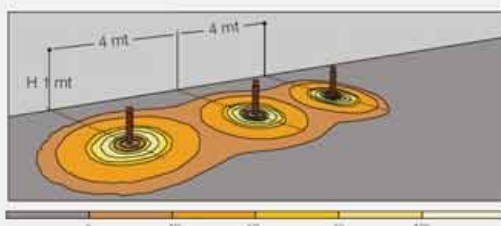

VERSO 175

ALIMENTATORI-KIT RGB (se non in dotazione) da ordinare dalla sezione arancio - DRIVERS-RGB KITS (when not supplied) to be ordered from the section orange color



outside

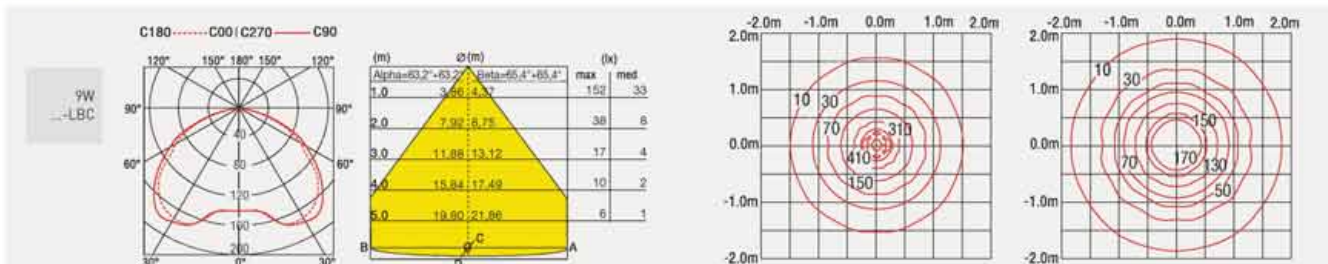

ALIMENTATORI-KIT RGB (se non in dotazione) da ordinare dalla sezione arancio - DRIVERS-RGB KITS (when not supplied) to be ordered from the section orange color



- Corpo e vano ottico in alluminio verniciato in polveri con pretrattamento speciale per esterni.
- Palo da pavimento in acciaio zincato e verniciato con polveri poliestere.
- Schermo in policarbonato trasparente. Viteria in acciaio inox.
- Cavo di alimentazione tipo H - lunghezza 2 m.
- Ottica omnidirezionale.

- Body made in die-cast aluminium with pre-treatment powder coating for outdoor installations.
- Pole with fixing plate made of powder coated galvanised steel.
- Transparent polycarbonate diffuser UV stabilized. Inox screws.
- Power cable H type - 2 m. length.
- Omnidirectional emission.



	LED					SISTEMA-SYSTEM		
	W	lm	V	K	CRI	W	lm	lm/W
A	VANO OTTICO - OPTICAL COMPARTMENT							
Br	E5676-LBC							
Ne	E5677-LBC							
Gr	E5678-LBC							
Bw	E5679-LBC							
	14W	1400	220-240V (500mA)	3000	>90	16W	850	53
Br	E5676-LBN							
Ne	E5677-LBN							
Gr	E5678-LBN							
Bw	E5679-LBN							
	14W	1400	220-240V (500mA)	4000	>90	16W	850	53

	PALO DA PAVIMENTO H 600 mm - POLE WITH FIXING PLATE H 600 mm			
Br	E5652			
Ne	E5653			
Gr	E5654			
Bw	E5655			

	PALO DA PAVIMENTO H 900 mm - POLE WITH FIXING PLATE H 900 mm			
Br	E5656			
Ne	E5657			
Gr	E5658			
Bw	E5659			

	COPRIBASE INOX - STAINLESS STEEL BASE COVER	
ACC.	894	Pozzetto per fissaggio interrato - Anclorage unit for ground fixing
	646308	Connettore IP68 Ø da 7 a 12mm IP68 connector Ø from 7 to 12mm
Ne	406407	Adattatore per palo ø 76/60 - Adaptor for pole ø 76/60
Gr	406419	
Bw	406408	

ESEMPIO ORDINE - ORDER EXAMPLE



ALIMENTATORI-KIT RGB (se non in dotazione) da ordinare della sezione arancio - DRIVERS-RGB KITS (when not supplied) to be ordered from the section orange color



IP 65
IK 08



outside

88W
-LBC

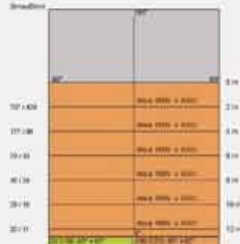
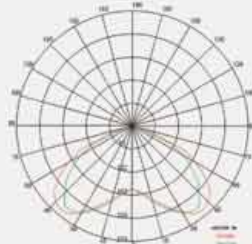

ALIMENTATORI-KIT RGB (se non in dotazione) da ordinare dalla sezione arancio - DRIVERS-RGB KITS (when not supplied) to be ordered from the section orange color



FRISBEE MAXI



- Corpo e vano ottico in alluminio verniciato in polveri con pretrattamento speciale per esterni.
- Schermo diffusore in policarbonato opale.
- Cavo di alimentazione H07RN-F 2x1,5mmq. - (DALI CAVO 5x1mmq.)
- Pressacavo in poliammide PG 13,5.
- Led durata utile: 50.000 (h) L80 B20.

- Body made in die-cast aluminium with pre-treatment powder coating for outdoor.
- Polycarbonate opal screen diffuser.
- Supply cable H07RN-F 2x1,5mmq. - (DALI CAVO 5x1mmq.)
- Cable gland in polyamide PG 13,5.
- Led life: 50.000 (h) L80 B20.

	LED	LED			SISTEMA-SYSTEM				
		W	lm	V	K	CRI	W	lm	IP
Ne E5690-LBC GrA E5691-LBC Gr E5692-LBC Bw E5693-LBC		88W	11700	220-240V (400mA)	3000	>90	81W	8775	96
Ne E5690-LBN GrA E5691-LBN Gr E5692-LBN Bw E5693-LBN		88W	12060	220-240V (400mA)	4000	>90	81W	9045	99
Ne E5690-LBC-DA GrA E5691-LBC-DA Gr E5692-LBC-DA Bw E5693-LBC-DA		88W	11700	220-240V (400mA)	3000	>90	81W	8775	96
Ne E5690-LBN-DA GrA E5691-LBN-DA Gr E5692-LBN-DA Bw E5693-LBN-DA		88W	12060	220-240V (400mA)	4000	>90	81W	9045	99

5kg
6,50

OP. A richiesta - On request

ACC. Ne **406207**
 Gr **406219** Palo da pavimento acciaio zincato verniciato - Ø 60 mm, spessore 2 mm. - H 3 m.
 GrA **406259** Painted galvanized steel floor pole - Ø 60 mm, thickness 2 mm. - H 3 m.
 Bw **406208**

Ne **406307**
 Gr **406319** Base palo da pavimento Ø 60 mm.
 GrA **406359** Base for floor pole Ø 60 mm.
 Bw **406308**

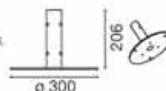

Ne **406407**
 Gr **406419** Riduzione attacco palo acciaio zincato verniciato Ø 76/60 mm.
 GrA **406459** Adaptor for pole Ø 76/60 mm.
 Bw **406408**

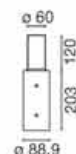

4071 Piastra tirafondi acciaio zincato verniciato
 Painted galvanized steel fixing plate with anchor belts

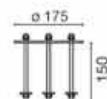

895 Pozzetto per fissaggio interrato
 Housing for ground fixing

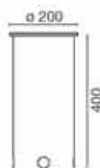





ELLE XS

- Corpo in pressofusione di alluminio.
- Verniciatura in polveri epossidiche con trattamento speciale per esterni.
- Guarnizioni in gomma silconica.
- Vetro di protezione temperato.
- Pressacavo in gomma silconica PG11.

- Body made of die-cast aluminum.
- Epoxy powder coated with special treatment for outdoor use.
- Silicone rubber gaskets
- Tempered protection glass.
- Cable gland PG11 silicone rubber.



H=500mm	H=900mm	LED					SISTEMA-SYSTEM		
		W	lm	V	K	CRI	W	lm	W
<p>LUCE SIMMETRICA CON BASETTA DA PAVIMENTO SYMMETRIC LIGHT WITH BASE FOR GROUND</p>									
<p>Gr E4071-LBC E4074-LBC Ne E4072-LBC E4075-LBC Bw E4073-LBC E4076-LBC</p>		12W	2000	220-240V (350mA)	3000	>90	14W	1870	173
<p>Gr E4071-LBN E4074-LBN Ne E4072-LBN E4075-LBN Bw E4073-LBN E4076-LBN</p>		12W	2100	220-240V (350mA)	4000	>90	14W	1943	139
<p>LUCE ASIMMETRICA CON BASETTA DA PAVIMENTO ASYMMETRIC LIGHT WITH BASE FOR GROUND</p>									
<p>Gr E4071AS-LBC E4074AS-LBC Ne E4072AS-LBC E4075AS-LBC Bw E4073AS-LBC E4076AS-LBC</p>		12W	2020	220-240V (350mA)	3000	>90	14W	1860	133
<p>Gr E4071AS-LBN E4074AS-LBN Ne E4072AS-LBN E4075AS-LBN Bw E4073AS-LBN E4076AS-LBN</p>		12W	2100	220-240V (350mA)	4000	>90	14W	1930	138

H=900mm	LED					SISTEMA-SYSTEM			
	W	lm	V	K	CRI	W	lm	W	
<p>LUCE SIMMETRICA CON PALO DA INTERRARE SYMMETRIC LIGHT WITH POLE FOR GROUND</p>									
<p>Gr E4068-LBC Ne E4069-LBC Bw E4070-LBC</p>		12W	2020	220-240V (350mA)	3000	>90	14W	1870	173
<p>Gr E4068-LBN Ne E4069-LBN Bw E4070-LBN</p>		12W	2100	220-240V (350mA)	4000	>90	14W	1943	139
<p>LUCE ASIMMETRICA CON PALO DA INTERRARE ASYMMETRIC LIGHT WITH POLE FOR GROUND</p>									
<p>Gr E4068AS-LBC Ne E4069AS-LBC Bw E4070AS-LBC</p>		12W	2020	220-240V (350mA)	3000	>90	14W	1960	133
<p>Gr E4068AS-LBN Ne E4069AS-LBN Bw E4070AS-LBN</p>		12W	2100	220-240V (350mA)	4000	>90	14W	1930	138

IP 65



outside

ALIMENTATORI-KIT RGB (se non in dotazione) da ordinare dalla sezione arancio - DRIVERS-RGB KITS (when not supplied) to be ordered from the section orange color





- Corpo in pressofusione di alluminio.
- Verniciatura in polveri epossidiche con trattamento speciale per esterni.
- Guarnizioni in gomma siliconica.
- Vetro di protezione temperato.
- Pressacavo in gomma siliconica PG11.

- Body made of die-cast aluminum.
- Epoxy powder coated with special treatment for outdoor use.
- Silicone rubber gaskets
- Tempered protection glass.
- Cable gland PG11 silicone rubber.



AS

	LED					SYSTEM-SYSTEM		
	W	lm	V	K	CRI	W	lm	lm/W
CON PALO DA INTERRARE WITH POLE TO BURY								
Gr E4100-LBC								
Ne E4101-LBC	60W	8450	220-240V (850mA)	3000	>90	64W	7450	116
Bw E4102-LBC								
Gr E4100-LBN								
Ne E4101-LBN	60W	8780	220-240V (850mA)	4000	>90	64W	7741	121
Bw E4102-LBN								

Palo disponibile fino ad una lunghezza di 6 m, total
Pole available till a maximum length of 6 m.

ACC. **PER FISSAGGIO A PAVIMENTO - FOR FLOOR INSTALLATION**

Gr P410-P
Ne P411-P Base palo - Pole base
Bw P412-P

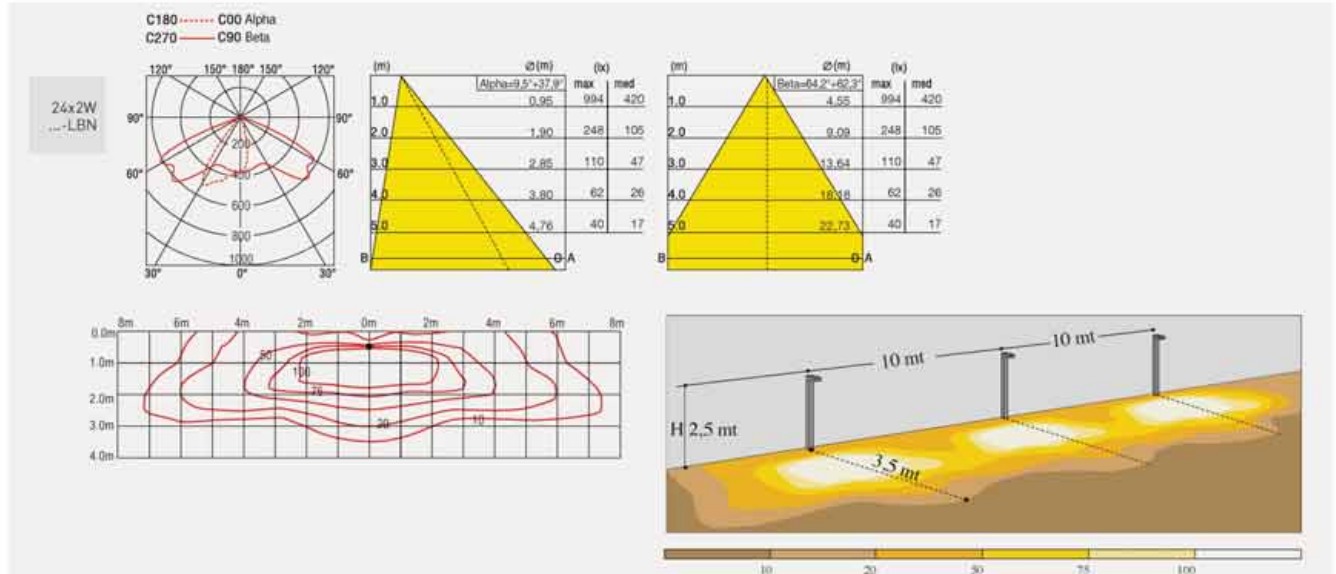
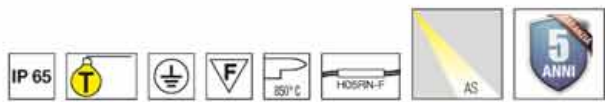

ALIMENTATORI-KIT RGB (se non in dotazione) da ordinare della sezione arancio - DRIVERS-RGB KITS (when not supplied) to be ordered from the section orange color

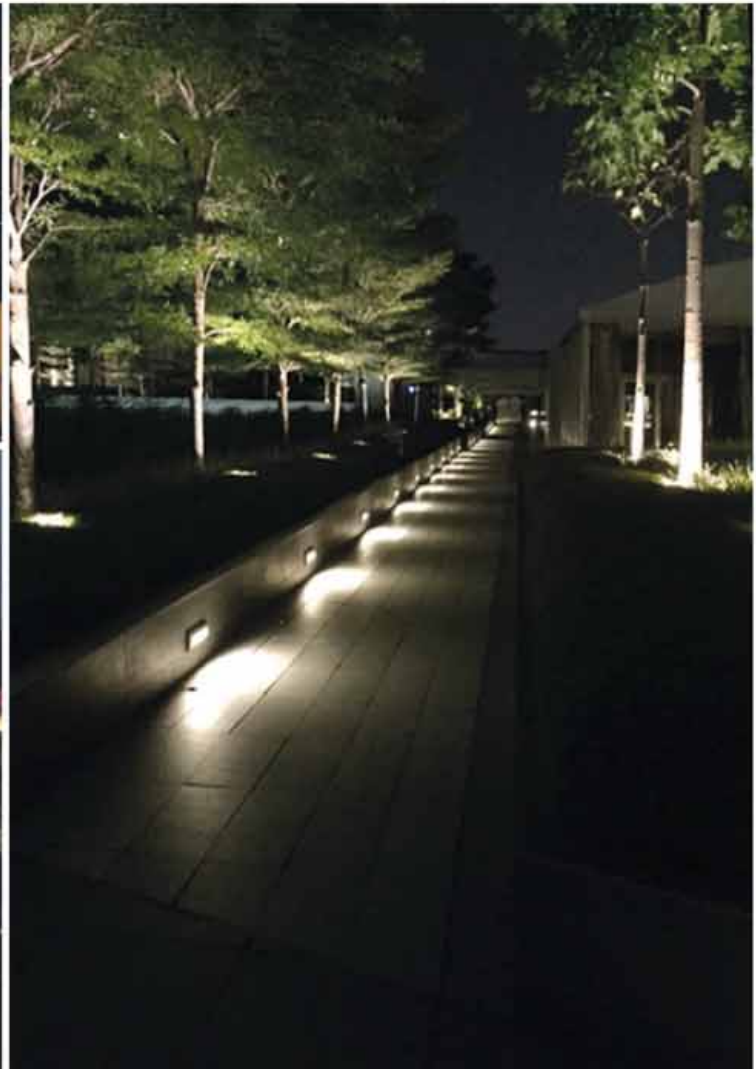

ALIMENTATORI - ACCESSORI DRIVERS - ACCESSORIES









- 656 ALIMENTATORI
DRIVERS
- 662 KIT ALIMENTATORI-MISCELATORI RGB
MIXER KITS-RGB DRIVERS
- 668 ACCESSORI
ACCESSORIES

ON-OFF (mA)

ALIMENTATORI · DRIVERS

		WATT	IP	ENTRATA INPUT	USCITA OUTPUT	CODICE CODE
ALIMENTATORI REMOTI PER POWERLED - POWERLED REMOTE TRANSFORMER						
<p>A=40 - B=62 - C=23</p>		8W	IP20	220-240Vac	200mA	646312
		8W	IP20	100-240Vac	350mA	644758
<p>A=31 - B=51 - C=21</p>		9W	IP20	220-240Vac 50/60Hz	250mA	645981
<p>A=35 - B=715 - C=20</p>		15W	IP20	120-240Vac 50/60Hz	350mA	644759-1
<p>A=92 - B=102 - C=23</p>		17W	IP67	90-264Vac 50/60Hz	350mA	645673
		14W	IP67	220-240Vac	350mA	646364
		10,5-15W	IP20	220-240Vac 50/60Hz	350mA	645984
<p>A=94 - B=190 - C=75</p>		13W	IP67	220-240Vac	350mA	646258-67
		15W	IP68	220-240Vac 50/60Hz	350mA	J350-68-LED
<p>A=40 - B=140 - C=30</p>		20W	IP20	190-250Vac 50/60Hz	500mA	645086
		14+28W	IP67	220-240Vac 50/60Hz	500mA	645626-1
<p>A=36 - B=120 - C=24,5</p>		6W	IP20	100-240Vac 50/60Hz	500mA	644758-5
<p>A=31 - B=51 - C=21</p>		12W	IP40	190-250Vac 50/60Hz	700mA	644940
<p>A=50 - B=117 - C=30</p>		12W	IP67	100-240Vac 50/60Hz	700mA	644940-67
<p>A=40 - B=110 - C=25</p>		25W	IP40	190-250Vac 50/60Hz	700mA	644936
<p>A=40 - B=140 - C=30</p>		25W	IP67	190-250Vac 50/60Hz	700mA	644936-67
<p>A=80 - B=250 - C=50</p>		10W	IP68	190-250Vac 50/60Hz	700mA	J700-68-LED
<p>A=94 - B=190 - C=75</p>		15W 24W 32W	IP20	110-240Vac 50/60Hz	350mA 500mA 700mA	645588
<p>A=67 - B=103 - C=21</p>		21W 25W 27W 30W	IP20	220-240Vac 50/60Hz	500mA 600mA 650mA 700mA	646349-1
<p>A=43 - B=145 - C=29,5</p>		34W 38W 40W 44W	IP20	220-240Vac 50/60Hz	800mA 900mA 950mA 1050mA	646168-1
<p>A=52 - B=110 - C=22</p>		22-30W	IP20	220-240Vac 50/60Hz	700mA	645688
<p>A=83 - B=155 - C=35</p>		39W 42W 44W 46W 51W	IP20	220-240Vac 50/60Hz	900mA 950mA 1000mA 1050mA 1200mA	645764
<p>A=52 - B=110 - C=22</p>		10W	IP40	100-240Vac 50/60Hz	500mA	645496
<p>A=43 - B=131 - C=30</p>		6W 10W 15W 20W 20W	IP20	220-240Vac 50/60Hz	150mA 250mA 350mA 500mA 700mA	645906
<p>A=35 - B=70 - C=21,5</p>		6W	IP20	220-240Vac 50/60Hz	150mA	646209

ALIMENTATORI REMOTI PER POWERLED - POWERLED REMOTE TRANSFORMER

	WATT	IP	ENTRATA INPUT	USCITA OUTPUT	CODICE CODE
NB Pulsante a rilascio max 10 alimentatori Parallel connection for max10 driver controlled by the same push-button  A=75 - B=147 - C=30 $t_a = -10^{\circ}\text{--}45^{\circ}$ $t_c = 75^{\circ}$	27W	IP40	190-260Vac 50/60Hz	350mA	644973
 A=40 - B=140 - C=30 $t_a = 40^{\circ}$ $t_c = 75^{\circ}$	17W	IP40	100-250Vac 50/60Hz	700mA	644973-1
 A=67 - B=103 - C=21 $t_a = -20^{\circ}\text{--}50^{\circ}$ $t_c = 75^{\circ}$ 1-10V	15W 22W 25W 9W 10W 20W	IP20	220-240Vac 50/60Hz	350mA 500mA 700mA 10Vdc 12Vdc 24Vdc	644757
ACC. Cavetto 945384-1 per sincronizzare max 10 alimentatori in serie Synchronization cable for max 10 drivers supplies 945384-1  A=80 - B=124 - C=22 $t_a = -20^{\circ}\text{--}45^{\circ}$ $t_c = 75^{\circ}$ ACC. Cavetto 945384-1 per sincronizzare max 10 alimentatori in serie Synchronization cable for max 10 drivers supplies 945384-1	25W 35W 50W 60W 60W 50W	IP20	200-240Vac 50/60Hz	350mA 500mA 700mA 900mA 1050mA 48Vdc	645384
DIMMERABILE TAGLIO DI FASE PHASE CUT DIMMABLE  A=51 - B=102 - C=29,5 $t_a = -25^{\circ}\text{--}50^{\circ}$ $t_c = 75^{\circ}$	15W	-	220-240Vac 50/60Hz	500mA	645833
DIMMERABILE TAGLIO DI FASE PHASE CUT DIMMABLE  A=53 - B=119 - C=30 $t_a = -20^{\circ}\text{--}50^{\circ}$	25W	-	220-240Vac 50/60Hz	700mA	645837-1
DIMMERABILE TAGLIO DI FASE PHASE CUT DIMMABLE  A=54 - B=153 - C=36 $t_a = -20^{\circ}\text{--}45^{\circ}$ $t_c = 75^{\circ}$	35W	-	220-240V 50/60Hz	700mA	645838-1
PUSH  1-10V A=52 - B=110 - C=22 $t_a = -25^{\circ}\text{--}20^{\circ}$ $t_c = 80^{\circ}$	15W 20W 20W 20W 20W	IP20	220-240Vac 50/60Hz	350mA 500mA 550mA 700mA 850mA 900mA	645938

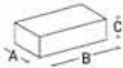

ALIMENTATORI REMOTI PER LED DI LUMINANZA 48V - LUMINANCE DIODES REMOTE TRANSFORMER 48V



	WATT	IP	ENTRATA INPUT	USCITA OUTPUT	LED MAX	CODICE CODE
 A=60 - B=225 - C=36 $t_a = -40^{\circ}\text{--}45^{\circ}\text{C}$ $t_c = 70^{\circ}$	50W	IP20	220-240Vac 50/60Hz	48Vdc		646433
 A=52 - B=180 - C=30 $t_a = -15^{\circ}\text{--}45^{\circ}\text{C}$ $t_c = 85^{\circ}$	75W	IP20	220-240Vac 50/60Hz	48Vdc		646434
 A=40 - B=300 - C=30 $t_a = -15^{\circ}\text{--}45^{\circ}\text{C}$ $t_c = 80^{\circ}$	120W	IP20	220-240Vac 50/60Hz	48Vdc		646435

		WATT	IP	ENTRATA INPUT	USCITA OUTPUT	LED MAX	CODICE CODE
ALIMENTATORI REMOTI PER LED DI LUMINANZA 24V - LUMINANCE DIODES REMOTE TRANSFORMER 24V							
A=34 - B=115 - C=20		10W	IP20	95-240Vac 50/60Hz	24Vdc		644599
A=53 - B=270 - C=41		20W	IP20	120-240Vac 50/60Hz	24Vdc		645606
A=53 - B=270 - C=41		96W	IP20	120-240Vac 50/60Hz	24Vdc		645178
A=53 - B=270 - C=41		150W	IP20	120-240Vac 50/60Hz	24Vdc		645179
A=55 - B=268 - C=51		150W	IP67	230-240Vac 50/60Hz	24Vdc		645177
A=45 - B=254 - C=35		60W	IP20	120-240Vac 50/60Hz	24Vdc		645038
A=90 - B=237 - C=34		100W	IP67	120-240Vac 50/60Hz	24Vdc		645216
A=45 - B=178 - C=38		20W	IP67	220-240Vac 50/60Hz	24Vdc		645489
A=52 - B=243 - C=32		75W	IP67	120-240Vac 50/60Hz	24Vdc		645490
A=37.5 - B=244 - C=71		250W	IP67	100-305Vac 50/60Hz	24Vdc		646371

ALIMENTATORI REMOTI PER LED DI LUMINANZA 12V - LUMINANCE DIODES REMOTE TRANSFORMER 12V							
A=48 - B=95 - C=30		10W	IP20	230Vac 50Hz	12Vdc		644888
A=40 - B=185 - C=25		20W	IP20	220-240Vac 50/60Hz	12Vdc		645469
A=45 - B=254 - C=35		50W	IP20	120-240Vac 50/60Hz	12Vdc		644889
A=63 - B=270 - C=41		100W	IP20	120-240Vac 50/60Hz	12Vdc		645474
A=65 - B=270 - C=41		150W	IP20	120-240Vac 50/60Hz	12Vdc		645567
A=50 - B=248 - C=49		70W	IP67	230-240V 50/60Hz	12Vdc		645176
A=90 - B=237 - C=34		100W	IP67	120-240Vac 50/60Hz	12Vdc		645475
DIMMERABILE TAGLIO DI FASE PHASE CUT DIMMABLE		60W	IP67	220-240Vac 50/60Hz	12Vdc		645544
DIMMERABILE 1-10V DIMMABLE 1-10V		120W	IP67	220-240Vac 50/60Hz	12Vdc		645746
DIMMERABILE 1-10V DIMMABLE 1-10V		70W	IP20	230-240Vac 50Hz	12Vac		645586

ALIMENTATORI E CONVERTITORI DIMMER • DRIVER AND CONVERTER DIMMER (V)

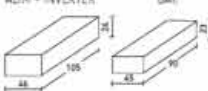
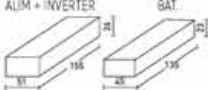
ALIMENTATORI REMOTI DI EMERGENZA - SAFETY REMOTE TRANSFORMER

 <p>ALIM + INVERTER BAT</p>	<p>Alimentatore con inverter integrato + batteria 1h Driver with built-in inverter + battery 1h</p>	5W	IP20	230Vac 50Hz	350mA	max 4 LED	INV 1051
 <p>ALIM + INVERTER BAT</p>	<p>Solo inverter + batteria Alimentatore max 15W - (da ordinare a parte) Only inverter + battery Driver max 15W - (to be ordered)</p>		IP20	220-240Vac 50/60Hz	350mA	max 12 LED	645408
 <p>A=120 - B=250 - C=90</p>	<p>Emergenza - emergency kit 1h Emergenza - emergency kit 3h</p>		IP20	220-240Vac 50/60Hz		LED COB	INV 1052 INV 1052-3

CENTRALINA DI CONTROLLO RGB - RGB CONTROL GEAR CASE

	<p>Centralina di controllo DMX per scatola da incasso tipo 503 DMX Control gear case for box 503</p>		IP20		12Vac		645262
---	--	--	------	--	-------	--	--------

ALIMENTATORI REMOTI PER POWERLED - POWERLED REMOTE TRANSFORMER

	WATT	IP	ENTRATA INPUT	USCITA OUTPUT	CODICE CODE
 <p>A=40 - B=50 - C=21</p>	4W	IP20	Vdc = 9-24 Vac = 9-18 Hz = 0-60	350mA	645062
 <p>A=31 - B=51 - C=21</p>	27W	IP20	12-24Vdc	500mA	645382
 <p>A=31 - B=51 - C=21</p>	28W	IP20	12-24Vdc	700mA	645383
 <p>A=39 - B=53 - C=25</p>	22W	IP20	12-24Vdc	3x350mA	645399
 <p>A=10 - B=45 - C=10</p>	7W	IP20	12-24Vdc	350mA	645393

ALIMENTATORI REMOTI PER POWERLED - POWERLED REMOTE TRANSFORMER

	WATT	IP	ENTRATA INPUT	USCITA OUTPUT	DIMMER	CODICE CODE
 <p>A=44 - B=44 - C=25</p>	120-240-480W	IP20	12-24-48Vdc	1x max 8A	Pot. 22K Anal. 0-10V 0-10V	645739-010
 <p>A=44 - B=44 - C=25</p>	120-240-480W	IP20	12-24-48Vdc	1x max 8A	Pulsante N.A.	645739-BTN
 <p>A=44 - B=44 - C=25</p>	120-240-480W	IP20	12-24-48Vdc	1x max 8A	PWM 200-400Hz	645739-BTR
 <p>A=44 - B=44 - C=25</p>	120-240-480W	IP20	12-24-48Vdc	1x max 8A	PWM max 250Hz * Pulsante N.A.	645739-DALI
 <p>A=44 - B=44 - C=25</p>	120-240-480W	IP20	12-24-48Vdc	1x max 8A	PWM max 250Hz * Pulsante N.A.	645739-DMX

* IN CASO DI ASSENZA DEL SEGNALE DIGITALE - IN CASE OF ABSENCE OF THE DIGITAL SIGNAL

SCHEMI DI COLLEGAMENTO PER DIMMER LED DI LUMINANZA - LUMINANCE DIODES DIMMABLE CONNECTING LAYOUT

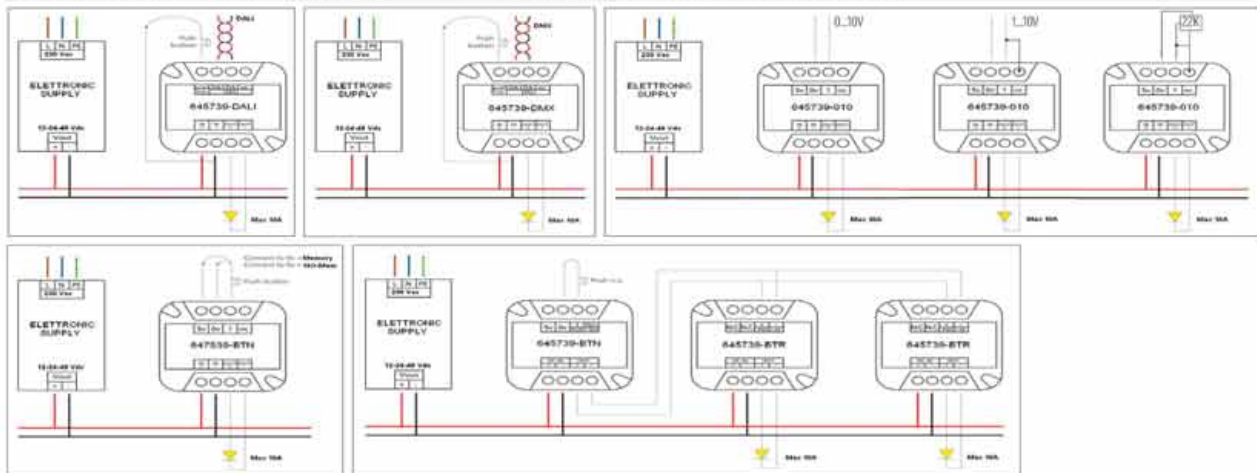

			WATT	IP	ENTRATA INPUT	USCITA OUTPUT	LED MAX	USCITA OUTPUT	LED MAX	CODICE CODE
ALIMENTATORI ELETTRONICI DIMMERABILE DALI - ELECTRONIC DIMMABLE DALI BALLAST										
A=79 - B=139 - C=33			60W	IP20	220-240Vac 50/60Hz	1050mA	-	DALI PUSH	INDIP. CL I	645683-I
		$t_a = -20^{\circ}\text{C}$ $t_c = 80^{\circ}$								
A=47 - B=220 - C=44			80W	IP20	220-240Vac 50/60Hz	24Vdc	-	DALI touch Dim	INDIP. CL II	645686
		$t_a = -20^{\circ}\text{C}$ $t_c = 75^{\circ}$								
A=77 - B=133 - C=48			50W	IP20	220-240Vac 50/60Hz	24Vdc	-	DALI STEP DIM, Astro DIM	INDIP. CL II	645687
		$t_a = -25^{\circ}\text{C}$ $t_c = 75^{\circ}$								
A=42 - B=207 - C=31			30W	IP20	220-240Vac 50/60Hz	700mA	12	DALI DSI	INDIP. CL II	645688-DA
		$t_a = -25^{\circ}\text{C}$ $t_c = 90^{\circ}$								
A=67 - B=103 - C=29,5			29W	IP20	220-240Vac 50/60Hz	700mA	10	DALI touch Dim	DIP. CL II	645839
		$t_a = -20^{\circ}\text{C}$ $t_c = 75^{\circ}$								
A=67 - B=103 - C=29,5			35W	IP20	220-240Vac 50/60Hz	1050mA	-	DALI touch DIM	DIP. CL II	645840
		$t_a = -20^{\circ}\text{C}$ $t_c = 75^{\circ}$								
A=67 - B=103 - C=21			12W 15W 24W 32W 10W 20W	IP20	220-240Vac 50/60Hz	250mA 350mA 500mA 700mA 12Vdc 24Vdc	12 12 12 12 - -	DALI	INDIP. CL II	644757-DA
		$t_a = -25^{\circ}\text{C}$ $t_c = 75^{\circ}$								
A=79 - B=124,5 - C=22			29W 35W 50W 60W 60W	IP20	220-240Vac 50/60Hz	350mA 500mA 700mA 900mA 1050mA	20 20 20 18 14	DALI PUSH 1-10V	INDIP. CL II	645384-DA
		$t_a = -25^{\circ}\text{C}$ $t_c = 85^{\circ}$								
A=30 - B=280 - C=21			75W	IP20	220-240Vac 50/60Hz	350mA	Min 37 Max 70	DALI - DSI Switch DIM	DIP. CL I	645538
		$t_a = -20^{\circ}\text{C}$ $t_c = 70^{\circ}$								
A=30 - B=280 - C=21			35W	IP20	220-240Vac 50/60Hz	350mA	Min 20 Max 40	DALI - DSI Switch DIM	DIP. CL I	645658
		$t_a = -20^{\circ}\text{C}$ $t_c = 75^{\circ}$								
A=79 - B=129 - C=33			60W	IP20	220-240Vac 50/60Hz	1050mA	-	DALI PUSH	DIP. CL I	645683
		$t_a = -20^{\circ}\text{C}$ $t_c = 80^{\circ}$								
A=67 - B=138 - C=29,5			29W	IP20	220-240Vac 50/60Hz	700mA	-	DALI	INDIP.	645839-I
		$t_a = -20^{\circ}\text{C}$ $t_c = 65^{\circ}$								
A=67 - B=138 - C=29,5			35W	IP20	220-240Vac 50/60Hz	1050mA	-	DALI	INDIP.	645840-I
		$t_a = -20^{\circ}\text{C}$ $t_c = 75^{\circ}$								
Cavetto per sincronizzare max 10 alimentatori in serie Synchronization cable for max 10 driver supplies								1 mt 4 mt	645384-1 645384-4	



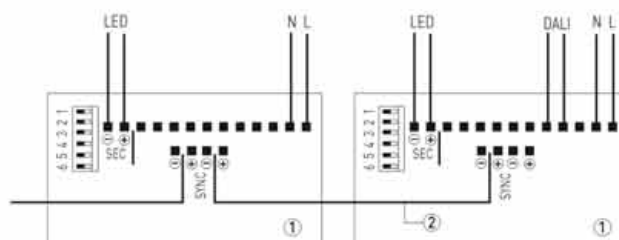

Schema di collegamento con segnale DALI
Wiring with DALI signal

- 644757-DA
645384-DA
- 645384-1
645384-4



Max. 10 alimentatori in serie
Max. 10 drivers in looping connection

	WATT	IP	ENTRATA INPUT	USCITA OUTPUT	LED MAX	USCITA OUTPUT	LED MAX	CODICE CODE
ALIMENTATORI DIMMERABILI DALI-DSI-SWITCH DIM - DIMMABLE DALI-DSI-SWITCH-DIM DRIVER								
* Funzione Switch DIM con pulsante M.A. - Function Switch DIM with button N.O. ** Consider FUNCTION in abbinamento a rilevatori di presenza Consider FUNCTION combined to motion detector. Dimming range 1 - 100%	8W				150mA		12	
	13W				250mA		12	
	18W				350mA		12	
	21W				400mA		12	
	23W	IP20	220-240Vac		450mA	DALI	10	645939
	25W		50/60Hz		500mA		9	
	25W				550mA		9	
	25W				600mA		8	
	25W			700mA		6		
A=52 - B=110 - C=22							ta = -25°-45° tc = 75°	
 	45W				1050mA		-	
	52W				1200mA		-	
	55W	IP20	220-240Vac		1400mA	DALI	-	645845
	55W		50/60Hz		1600mA		-	
	55W				1750mA		-	
	55W				2100mA		-	
A=75 - B=129 - C=30							ta = -25°-50° tc = 85°	

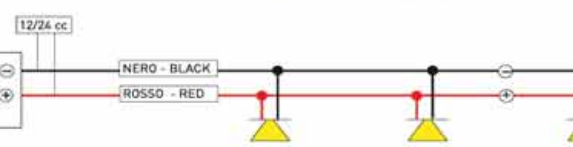
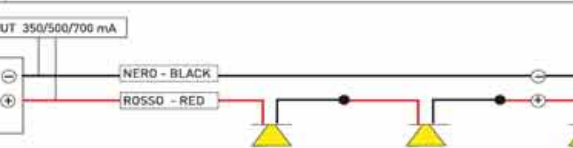
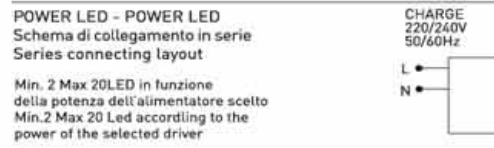
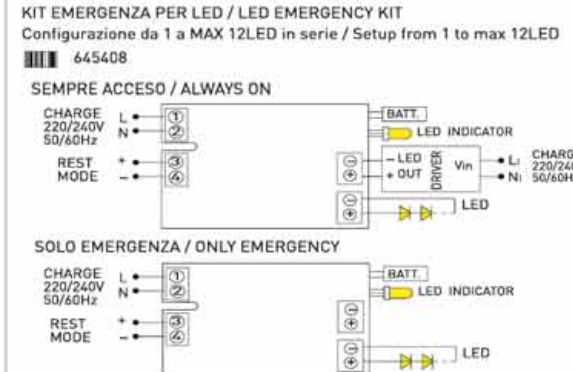
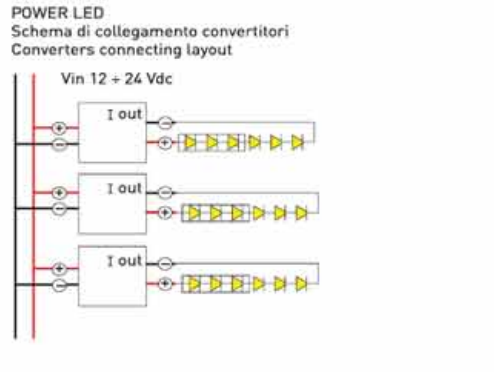
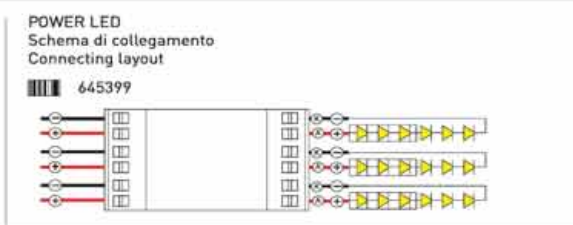
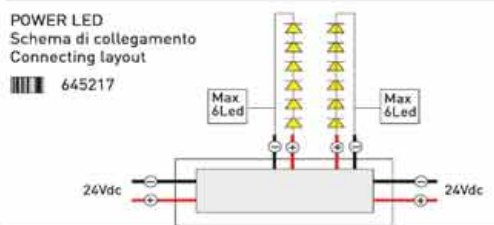

POWER LED RGB

KIT ALIMENTATORI-MISCELATORI RGB · RGB POWER SUPPLIES-MIXER KITS

ALIMENTATORE POWER SUPPLY	MISCELATORE COLOR MIXER	MISCELATORE COLOR MIXER	IP	LED/W MAX	ENTRATA INPUT	USCITA OUTPUT	CODICE CODE	
KIT POWER LED 350mA								
				IP20	max 6 sorgenti RGB sources RGB	230V-240V 50-60HZ	24Vdc	646372-1

COLLEGAMENTO - WIRING

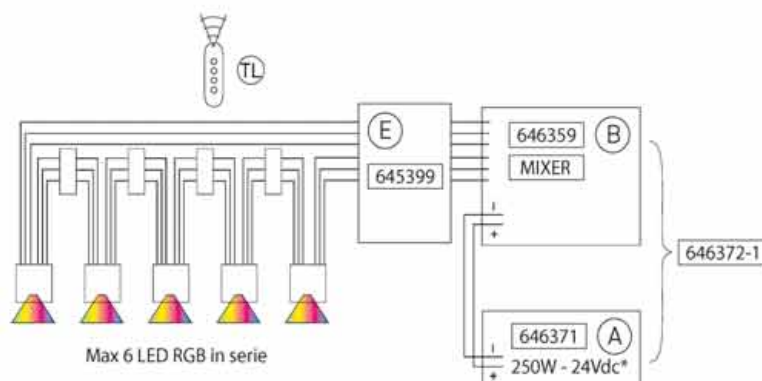
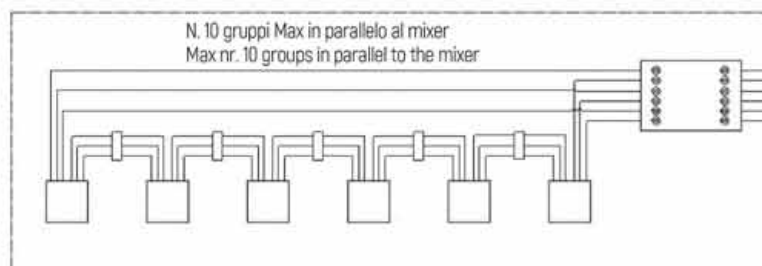

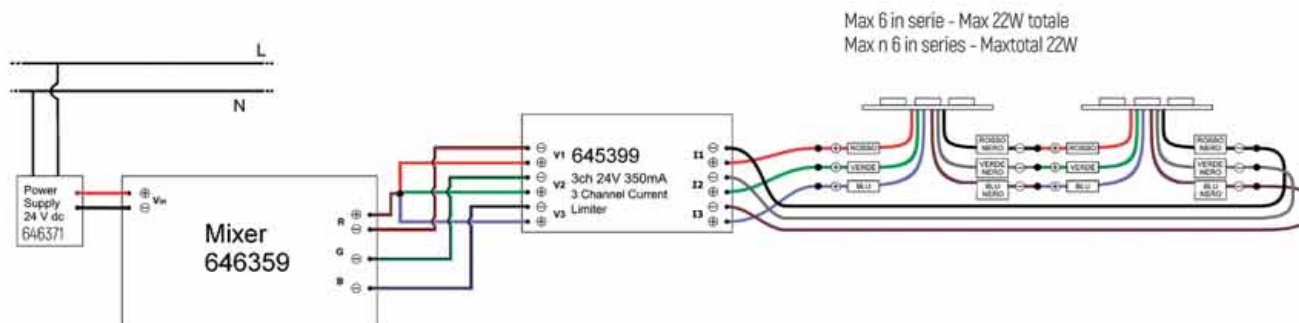

(A) ALIMENTATORE - CONTROL GEAR	646371	(TL) TELECOMANDO - REMOTE CONTROL
(B) MIXER	646359	
(E) CONVERTITTORE - CONVERTER	645399	

* NB. Il codice dell'alimentatore è riferito alla massima potenza gestita dal mixer.
Dimensionare alimentatore in funzione della potenza degli apparecchi.
The control gear code refers to the maximum power managed by the mixer.
Select the control gear according to the total power of the fittings.



ATTENZIONE: per il collegamento vedere lo schema elettrico in allegato all'apparecchio
ATTENTION: for connection see the circuit diagram supplied with the fitting

APPARECCHI DI RIFERIMENTO - REFERENCE LIGHTING FITTING

- 
MATRIX MINI
- 
CO-LIGHT MINI
- 
JOCKER 3 LED
- 
SUBMARINER 140
- 
MONOLIGHT105
- 
DOUBLE LIGHT 105
- 
CEILING 105
- 
CEILING/S 105
- 
EYES B-1
- 
EYES
- 
OLODUM MICRO
- 
OLODUM MICRO PASS
- 
OLODUM MINI QUADRO
- 
OLODUM MIDI
1 APPARECCHIO - 6W4892/1
- 
SUBMARINER 175
1 APPARECCHIO - 6W4892/1
- 
SUBWATER 175
1 APPARECCHIO - 6W4892/1
- 
CIELO
- 
CIELO FLOOR

POWER LED RGB

KIT ALIMENTATORI-MISCELATORI RGB · RGB POWER SUPPLIES-MIXER KITS

ALIMENTATORE POWER SUPPLY		MISCELATORE COLOR MIXER		IP	LED/Watt MAX	ENTRATA INPUT	USCITA OUTPUT	CODICE CODE
LED 24Vcc								
				IP20	72W max per canale for channel	220V-240V 60HZ	24V dc	646372-3

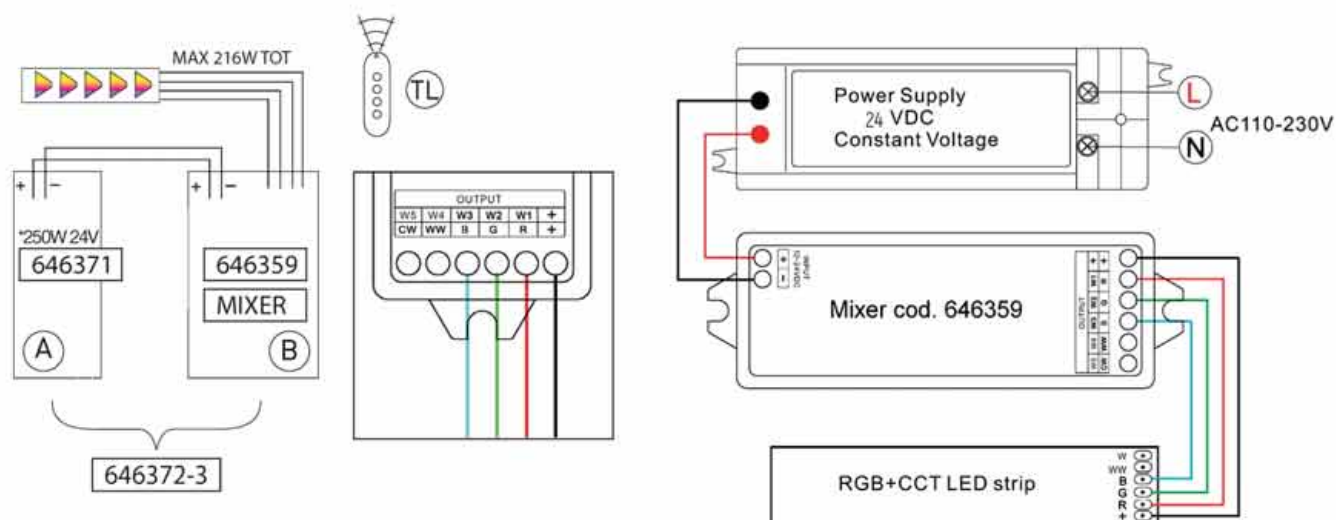

(A) ALIMENTATORE - CONTROL GEAR	646371	(TL) TELECOMANDO - REMOTE CONTROL
(B) MIXER	646359	

* NB. Il codice dell'alimentatore è riferito alla massima potenza gestita dal mixer.
Dimensionare alimentatore in funzione della potenza degli apparecchi.
The control gear code refers to the maximum power managed by the mixer.
Select the control gear according to the total power of the fittings.

APPARECCHI DI RIFERIMENTO - REFERENCE LIGHTING FITTING

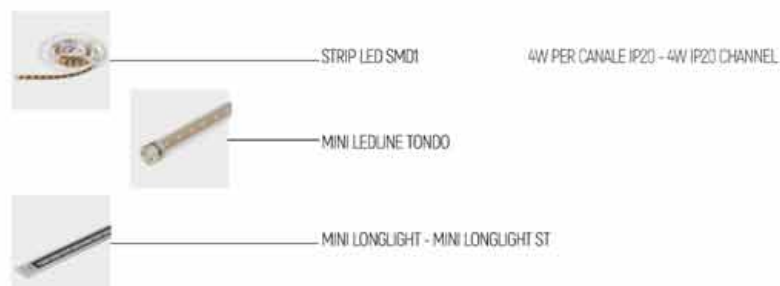

ATTENZIONE: per il collegamento vedere lo schema elettrico in allegato all'apparecchio
ATTENTION: for connection see the circuit diagram supplied with the fitting

ALIMENTATORE POWER SUPPLY		MISCELATORE COLOR MIXER		IP	LED/Watt MAX	ENTRATA INPUT	USCITA OUTPUT	CODICE CODE
LED 12Vcc								
				IP20	36W max per canale for channel	220V-240V 60HZ	12V dc	646372-2

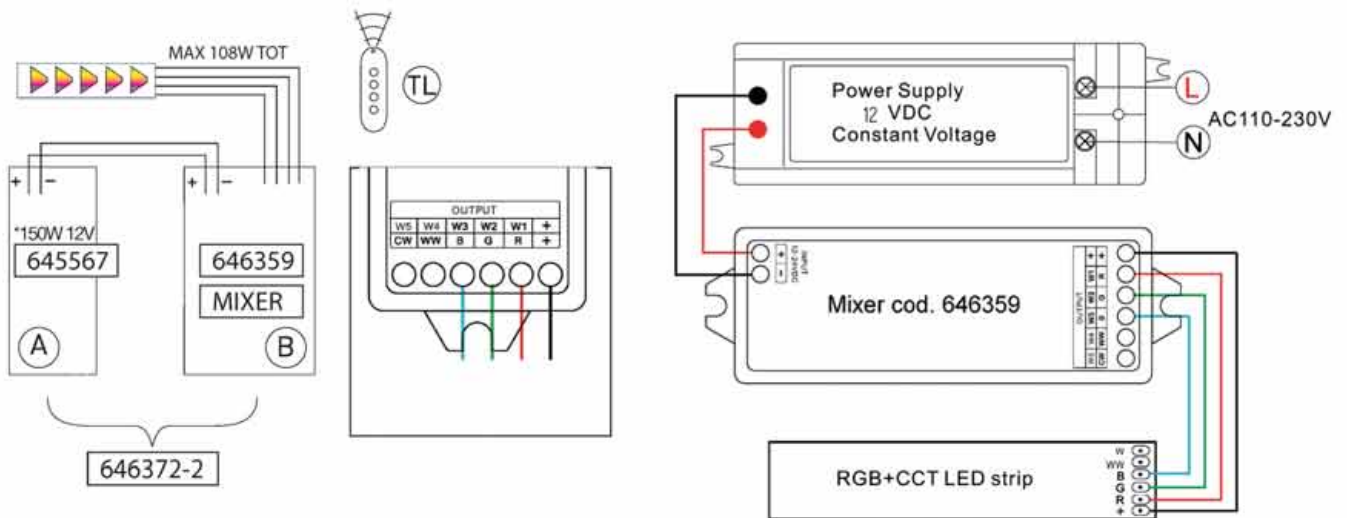

(A) ALIMENTATORE - CONTROL GEAR	645567	(TL) TELECOMANDO - REMOTE CONTROL
(B) MIXER	646359	

* NB. Il codice dell'alimentatore è riferito alla massima potenza gestita dal mixer.
Dimensionare alimentatore in funzione della potenza degli apparecchi.
The control gear code refers to the maximum power managed by the mixer.
Select the control gear according to the total power of the fittings.









APPARECCHI DI RIFERIMENTO - REFERENCE LIGHTING FITTING

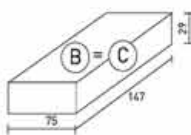

ATTENZIONE: per il collegamento vedere lo schema elettrico in allegato all'apparecchio
ATTENTION: for connection see the circuit diagram supplied with the fitting

LED SMD RGB

KIT ALIMENTATORI-MISCELATORI RGB · RGB POWER SUPPLIES-MIXER KITS

ALIMENTATORE POWER SUPPLY		IP	LED/W MAX	ENTRATA INPUT	USCITA OUTPUT	CODICE CODE	
POWER LED 350mA							
			IP40	10W max per canale for channel	190/265V 50/60HZ	350mA	645247
		TELECOMANDO - REMOTE CONTROL				645245	
		SENSORE - SENSOR				645246	
		CAVETTO MULTIPOLARE - MULTIPOLAR CABLE				645280	

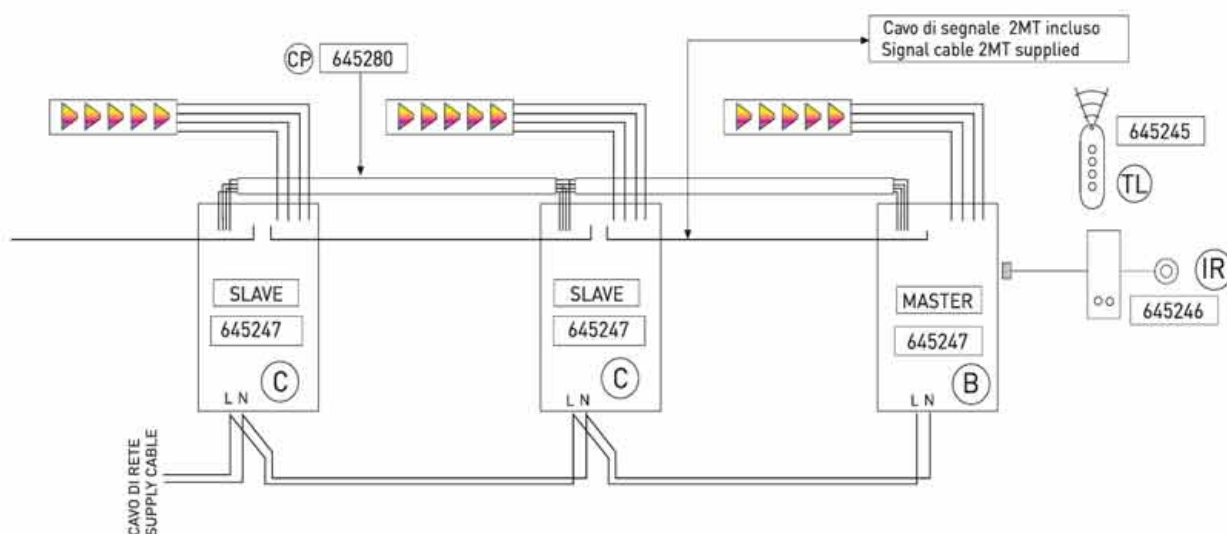

MASTER	SLAVE	645247		TELECOMANDO - REMOTE CONTROL	645245
	CAVETTO MULTIPOLARE MULTIPOLAR CABLE	645280		SENSORE - SENSOR	645246

N.B. In fase di installazione si raccomanda di attenersi rigorosamente alle istruzioni allegate ai kit di alimentazione
N.B. During installation please observe strictly the power supplies kit instructions

APPARECCHI DI RIFERIMENTO - REFERENCE LIGHTING FITTING



WATT	IP	ENTRATA INPUT	USCITA OUTPUT	CODICE CODE
------	----	---------------	---------------	-------------

POWER LED

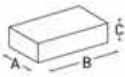

A=76 - B=153 - C=30,5

ta = -20°-50°C tc = 85°

50W	IP20	120-250Vac 50/60Hz	350mA	646375
-----	------	-----------------------	-------	--------

SCHEMA CABLAGGIO POWER LED RGB CON GESTIONE DMX/RDM - WIRING POWER LED RGB CONTROL BY DMX/RDM

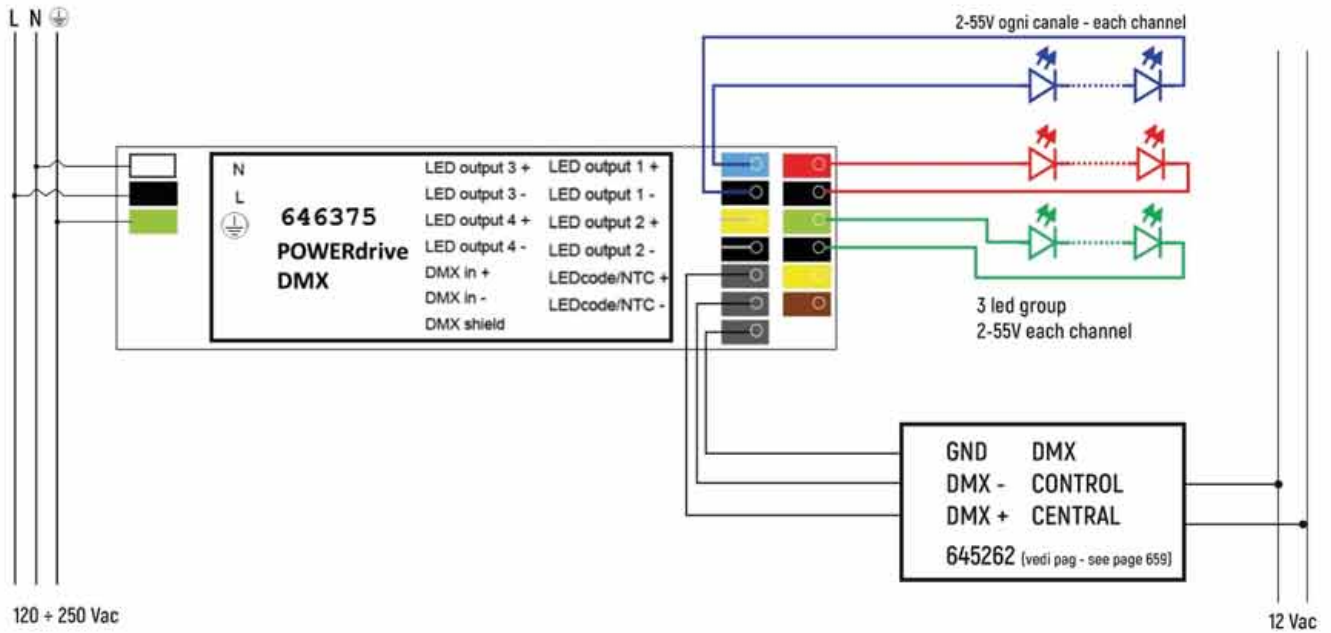

LAMPADINE LED - LED LAMP

Marca Brand	Codice Code	Watt	Volt mA	Fascio Beam	Lumen	CRI	Kelvin
AR 111 	646338-930	26W	700mA	15°	2350	>90	3000K
	646338-940	26W	700mA	15°	2500	>90	4000K
	646339-930	26W	700mA	24°	2250	>90	3000K
	646339-940	26W	700mA	24°	2400	>90	4000K
	646340-930	26W	700mA	40°	2150	>90	3000K
	646340-940	26W	700mA	40°	2300	>90	4000K
	646347-930	37W	1050mA	24°	2450	>90	3000K
	646347-940	37W	1050mA	24°	3800	>90	4000K
	646348-930	37W	1050mA	40°	3350	>90	3000K
	646348-940	37W	1050mA	40°	3550	>90	4000K

Marca Brand	Codice Code	Watt	Volt mA	Fascio Beam	Lumen	CRI	Kelvin
COIN 50 	646401-830	13W	350mA	24°	1400	>80	3000K
	646401-840	13W	350mA	24°	1500	>80	4000K
	646402-830	13W	350mA	40°	1350	>80	3000K
	646402-840	13W	350mA	40°	1400	>80	4000K
	646399-930	13W	350mA	15°	1050	>90	3000K
	646399-940	13W	350mA	15°	1100	>90	4000K
	646401-930	13W	350mA	24°	1050	>90	3000K
	646401-940	13W	350mA	24°	1100	>90	4000K
	646402-930	13W	350mA	40°	1050	>90	3000K
	646402-940	13W	350mA	40°	1100	>90	4000K

Marca Brand	Codice Code	Watt	Volt mA	Fascio Beam	Lumen	CRI	Kelvin
COIN 35 	646688-930	6W	350mA	24°	520	>90	3000K
	646688-940	6W	350mA	24°	550	>90	4000K
	646689-930	6W	350mA	36°	550	>90	3000K
	646689-940	6W	350mA	36°	600	>90	4000K

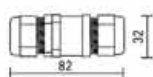
CODICE
CODE

Connettore IP68 per cavo diametro 7-12 mm
IP68 Socket for cable 7-12mm

646308

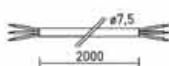

Cavo di alimentazione collegato 2 m
Power cable 2 m length

645229



Ventosa
Glass remover

E960



Basetta plafone per adattatore elettrico
Ceiling base for electric adaptor

Bl 990925
Ne 990926



Adattatore per incasso basetta
Recessed base adaptor

Bl 990930
Ne 990931

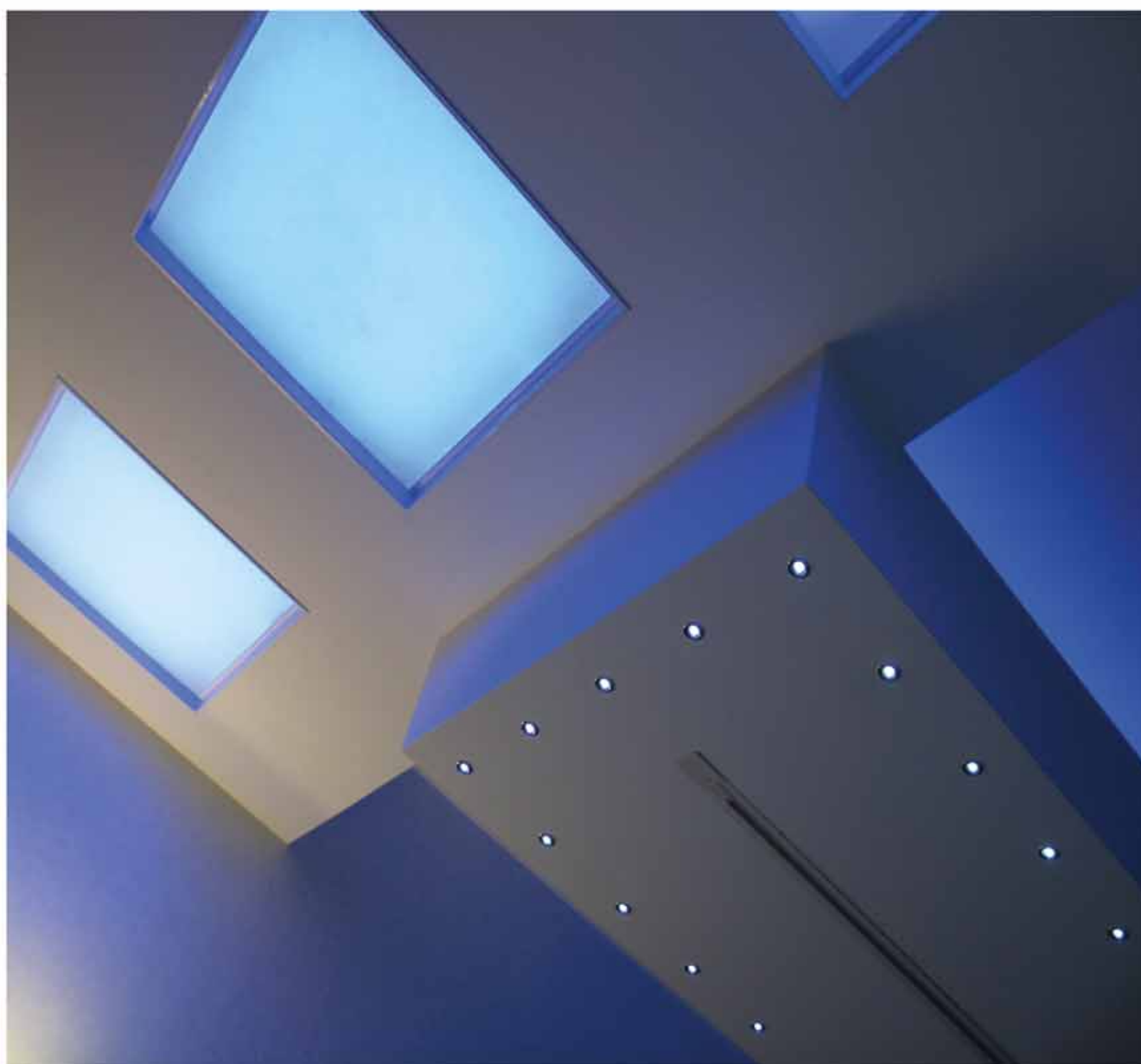

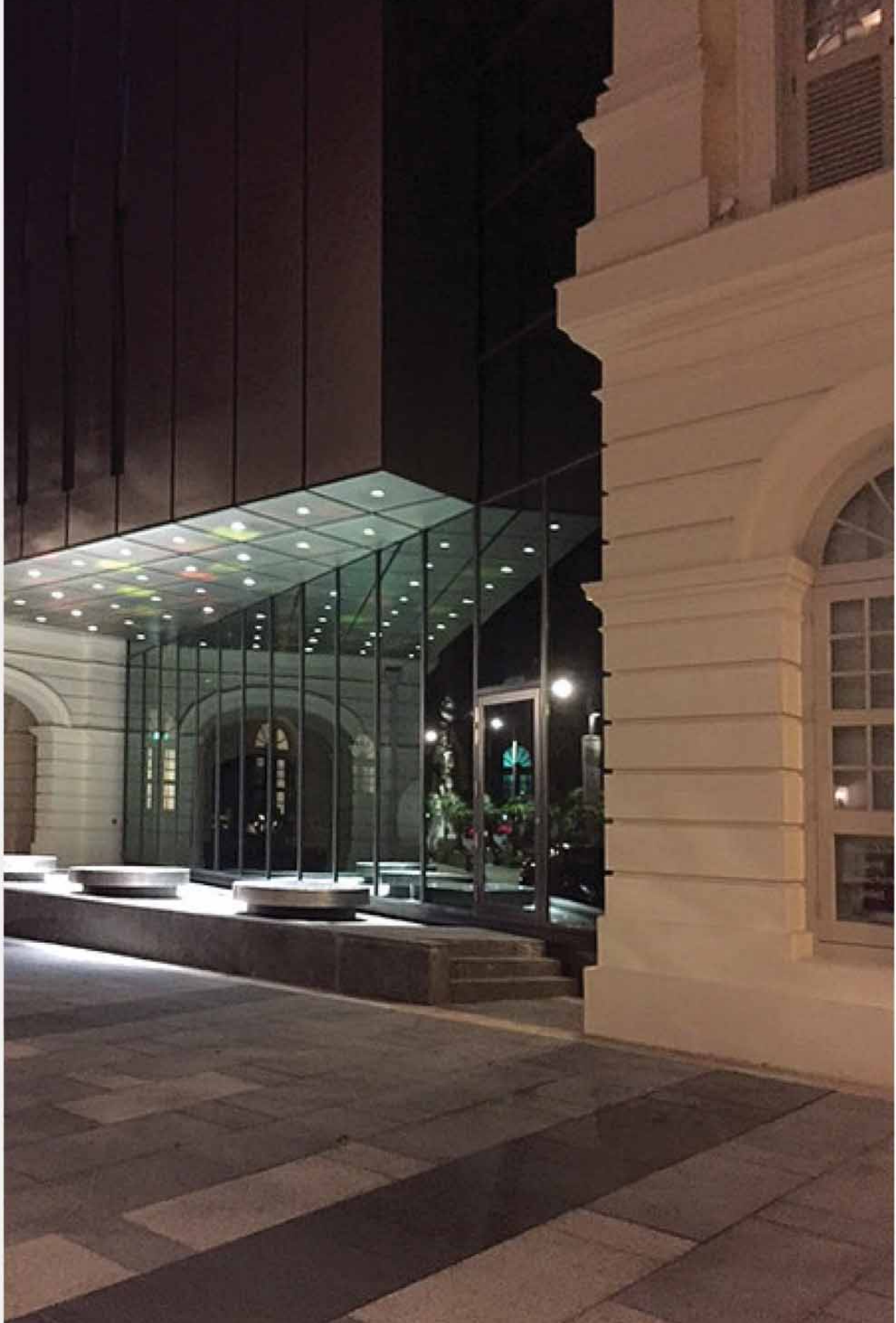

GRADO DI PROTEZIONE
PROTECTION DEGREE

IP ---

Prima cifra caratteristica / First characteristic numeral
Seconda cifra caratteristica / Second characteristic numeral
Resistenza meccanica / Shock resistance

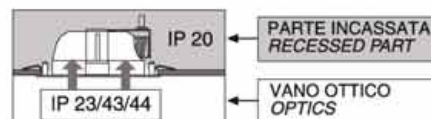

PRIMA CIFRA - FIRST NUMERAL			SECONDA CIFRA - SECOND NUMERAL			RESISTENZA AGLI URTI MECCANICI SHOCK RESISTANCE		
PROTEZIONE CONTRO LA PENETRAZIONE DI CORPI SOLIDI PROTECTION AGAINST PENETRATION OF SOLID OBJECTS			PROTEZIONE CONTRO LA PENETRAZIONE DI CORPI LIQUIDI PROTECTION AGAINST PENETRATION OF WATER					
0		Non protetto Non protected	0	–	Non protetto Not protected	0	Non protetto Not protected	Peso Weight h. caduta h. fall down
1	–	Protetto contro corpi solidi sup. a 50 mm Protected against solid objects greater than 50 mm	1		Protetto contro la caduta verticale di gocce d'acqua Protected against dripping water	1	Energia d'urto Shock resistance	0,025 150 g joule 15 cm
2	–	Protetto contro corpi solidi sup. a 12 mm Protected against solid objects greater than 12 mm	2	–	Protetto contro la caduta di gocce d'acqua con involucro inclinato max di 15° Protected against dripping water when tilted up to 15°	2	–	–
3	–	A prova di penetrazione di sonda con Ø 2,5 mm Protected against solid objects with Ø 2,5 mm	3		Protetto contro la pioggia Protected against spraying water	3	Energia d'urto Shock resistance	0,5 250 g joule 15 cm
4	–	A prova di penetrazione di sonda con Ø 1 mm Protected against solid objects with Ø 1 mm	4		Protetto contro spruzzi d'acqua Protected against splashing	4	–	–
5		Protetto contro la polvere / Dust-protected	5		Protetto contro i getti d'acqua Protected against water jets	5	Energia d'urto Shock resistance	2 500 g joule 40 cm
6		Stagno alla polvere / Dust-tight	6	–	Protetto contro le ondate Protected against heavy seas	6	–	–
			7		Stagno all'immersione Protected against the effects of immersion	7	Energia d'urto Shock resistance	6 1500 g joule 40 cm
			8		Stagno alla sommersione Protected against submersion	8	–	–
			9			9	Energia d'urto Shock resistance	20 5000 g joule 40 cm

GRADO DI PROTEZIONE DEGLI INVOLUCRI PER APPARECCHIATURE ELETTRICHE CONTRO IMPATTI MECCANICI ESTERNI (CODICE IK)
DEGREES OF PROTECTION PROVIDED BY ENCLOSURES FOR ELECTRICAL EQUIPMENT AGAINST EXTERNAL MECHANICAL IMPACTS (IK CODE)

RELAZIONE TRA IL CODICE IK E L'ENERGIA D'IMPATTO / RELATION BETWEEN IK CODE AND IMPACT ENERGY

CODICE IK IK CODE	IK00	IK01	IK02	IK03	IK04	IK05	IK06	IK07	IK08	IK09	IK10
ENERGIA DI IMPATTO IN JOULE IMPACT ENERGY JOULE	*	0,15	0,2	0,35	0,5	0,7	1	2	5	10	20

* NON PROTETTO SECONDO LA PRESENTE NORMA / NOT PROTECTED ACCORDING TO THIS STANDARD

ALTEZZA DI CADUTA / HEIGHT OF FALL

ENERGIA ENERGY	J	0,14	0,2	(0,3)	0,35	(0,4)	0,5	0,7	1	2	5	10	20		
MASSA EQUIVALENTE EQUIVALENT MASS	Kg	0,25	(0,2)	0,25	(0,2)	0,25	(0,2)	(0,2)	0,25	0,25	0,25	0,5	1,7	5	5
ALTEZZA DI CADUTA HEIGHT OF FALL	mm ± 1%	56	(100)	80	(150)	140	(200)	(250)	200	280	400	400	300	200	400

COMPOSTO CHIMICO - CHEMICAL AGENT	PMMA	PC	PA	PVC	AL	AISI
Acetone - Acetone	😞	😞	😞	😞	😄	😄
Acido arsenico al 20% - Arsenic acid 20%	😄	😄		😄	😞	😞
Acido citrico al 20% - Citric acid 20%	😄	😄	😄	😄	😞	😞
Acido acetico al 10% - Acetic acid 10%	😄	😄	😞	😄	😞	😞
Acido cloridrico - Hydrochloric acid	😄	😄	😞	😄	😞	😞
Acido cromico - Chromic acid	😞	😞	😞	😄	😞	😞
Acido formico fino al 30% - Formic acid up to 30%	😞	😞	😄	😄	😞	😞
Acido nitrico al 20% - Nitric acid 20%	😞	😞	😞	😄	😞	😞
Acido solforico fino al 30% - Sulphuric acid up to 30%	😄	😄	😞	😄	😞	😞
Acqua di mare - Sea water	😄	😄	😞	😞	😞	😄
Alcool etilico - Ethyl alcohol	😞	😄	😄	😄	😄	😄
Alcool isopropilico - Isopropyl alcohol	😞	😞	😄		😞	😄
Anilina - Aniline	😞	😞	😞	😞	😄	😄
Ammoniaca - Ammonia	😄	😞	😄	😞	😄	😞
Benzina - Petrol	😄	😄	😄	😄	😄	😄
Benzina super - High octane petrol	😄	😞	😞	😞	😄	😄
Benzolo - Benzol	😞	😞	😞	😞	😞	😄
Bevande alcoliche - Alcoholic beverages	😄	😄	😄	😄	😄	😄
Bromo - Bromine	😞	😞		😞	😞	😄
Calce bianca - White lime	😞	😞	😞	😞	😞	😄
Carburanti diesel - Diesel petrol	😞	😞	😞	😄	😄	😄
Clima marino - Sea atmosphere	😄	😄	😄	😄	😞	😞
Cloroformio - Chloroform	😞	😞	😞	😞	😄	😄
Cloro liquido (vapori) - Liquid chlorine (vapors)	😞	😞		😞	😄	😞
Cloruro di calcio - Calcium chloride	😄	😄	😄	😄	😄	😞
Cloruro di ferro - Iron chloride	😄	😞	😄	😄	😞	😞
Esano - Hexane	😄	😞	😄	😄	😄	😄

COMPOSTO CHIMICO - CHEMICAL AGENT	PMMA	PC	PA	PVC	AL	AISI
Etilere - Ethylether	😊	😞	😊	😞	😊	😊
Fenoli - Phenol	😞	😞	😞		😞	😊
Glicerina - Glycerine	😊	😞	😊	😊	😊	😊
Idrocarburi - Hydrocarbons	😞	😞			😊	😊
Metanolo - Methanol	😞	😞	😞	😊	😞	😊
Oli minerali - Mineral oils	😊	😞	😊	😊	😊	😊
Olio di silicone - Silicone oil	😞	😊	😊	😊	😊	😊
Olio diesel-nafta - Diesel oil - naphtha	😊	😞	😊	😊	😊	😊
Olio e grassi alimentari - Food fat-oil	😊	😞	😊	😊	😊	😊
Ozono - Ozone	😊	😞	😞	😞	😊	😞
Permanganato di potassio - Potassium permanganate	😊	😊	😊	😊	😞	😊
PVC con plastificanti - PVC with plasticizers	😞				😊	😊
Soda - Soda	😊	😞	😊	😊	😞	😞
Solfato acquoso di zinco - Watery zinc sulphate	😊	😊	😊	😊	😊	😊
Solfato di alluminio - Aluminium sulphate	😊	😊	😊	😊	😊	😊
Solfato di rame - Copper sulphate	😊	😊	😊	😊	😊	😞
Tetracloruro di carbonio - Carbon tetrachloride	😞	😞	😊	😞	😊	😊
Toluolo - Toluol	😞	😞	😞	😞	😊	😊
Tricloroetilene - Trichlorinethylene	😞	😞	😊		😊	😊

LEGENDA - LEGEND

PMMA
polimetilmetacrilato - polymethylmethacrylate

PC
policarbonato - polycarbonate

PA
poliammide - polyamide

PVC
cloruro di polivinile - polyvinyl chloride

AL
alluminio - aluminium

AISI
acciaio inossidabile - stainless steel

😊 resiste - resistant

😞 resiste relativamente - slight resistant

😞 non resiste - not resistant

Attenzione: i prodotti chimici della tabella sono una minima parte di quelli esistenti nelle diverse composizioni. Verificare la compatibilità tra i materiali componenti e l'ambiente d'installazione. Possono esserci delle variazioni nella compatibilità tra materiale e prodotto chimico in funzione della concentrazione e della temperatura.

Attention: the chemicals listed in the table are just a few of those which exist in various compositions. Check the compatibility between the material of the lighting fittings and the environment in which they have to be installed. There may be variations in the compatibility between the material and the chemical according to its concentration and temperature.

TIPOLOGIA DI INSTALLAZIONE - TYPES OF INSTALLATION

INCASSI
RECESSEDBINARIO
TRACKPLAFONE
CEILINGPARETE
WALLSOSPENSIONI
SUSPENSIONSINCASSI TERRA
INGROUNDIMMERSIONE
UNDERWATERPROIETTORI
PROJECTORSPALI
POSTS

BORDER

FASCI LUMINOSI - LIGHT BEAMS

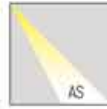
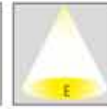
GRADO DI AMPIEZZA FASCIO
DEGREE OF WIDE BEAMSIMMETRICO - ASIMMETRICO
SYMMETRICAL - ASYMMETRICALELLITTICO
ELLIPTICALLAMA DI LUCE
BLADE OF LIGHT

SPOT



FLOOD

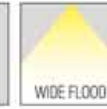

WIDE FLOOD

MONODIREZIONALE
UNIDIRECTIONALBIDIREZIONALE
BIDIRECTIONALOMNIDIREZIONALE
OMNIDIRECTIONALRADIALE MONODIREZIONALE
RADIAL MONODIRECTIONALRADIALE OMNIDIREZIONALE
RADIAL DIRECTIONAL

TIPOLOGIA DI FASCIO - BEAM TYPES

SIMMETRICO
SYMMETRICALASIMMETRICO
ASYMMETRICALORIENTABILE
ADJUSTABLEMONO - BIDIREZIONALE
MONO - BIDIRECTIONALLAMA DI LUCE
BLADE OF LIGHT

Codice apparecchio - Light fitting code

Colore finitura apparecchio - Source-fitting colour

Fornito senza sorgente luminosa, senza alimentatore - Supplied without lighting source, without driver

Fornito con sorgente luminosa, senza alimentatore - Supplied with lighting source, without driver

Fornito senza sorgente luminosa, con alimentatore remoto - Supplied without lighting source, with remote driver

Fornito con sorgente luminosa, con alimentatore remoto - Supplied with lighting source, with built-in driver

Fornito senza sorgente luminosa, con alimentatore - Supplied without lighting source, with built-in driver

Fornito con sorgente luminosa, con alimentatore - Supplied with lighting source, with built-in driver

Potenza max lampada - Max lamp watt

Tensione/corrente nominale di alimentazione - Nominal supply voltage/current

Temperatura di colore - Color temperature

Lumen (flusso luminoso) - Lumen (luminous flux)

Rendimento totale apparecchio - System efficiency

Resa cromatica - Color rendering index

Tipo di sorgente luminosa - Lighting source type

Sigla Ilcos - Ilcos classification

Tipo di attacco - Socket type

 Temperatura di contatto: Ta (temperatura ambiente) = 25°C (per installazioni all'esterno Ta = 15°C)
Surface temperature: Ta (ambient temperature) = 25°C (for outdoor installation Ta = 15°C)

Prezzo in Euro - Price in Euro

Prezzo a richiesta - Price on request

Calpestabilità - Walk on

Carrabilità - Drive on

Contro inquinamento luminoso - Against light pollution

 Anticorrosione per tutti gli apparecchi da esterno (1000 ore in nebbia salina secondo norma CEI EN 60068-2-11)
Anti-corrosion for all outdoor fittings (1000 hours in salt spray according to standard CEI EN 60068-2-11)VALORI DI VITA DEI MODULI LED
LIFE VALUE OF LED MODULE

valore "L" definisce la percentuale di flusso luminoso del modulo LED rispetto a quello iniziale in funzione delle ore di funzionamento utili (50000).

valore "B" definisce la quantità in percentuale di moduli LED che sono al di sotto dello specifico valore L, ovvero che NON mantengono il flusso dichiarato.

es. 50000 (h) L90 B10 significa che dopo le ore di funzionamento indicate il 10% dei moduli hanno un flusso luminoso inferiore al 90% di quello iniziale.

Value L: it defines the percentage of luminous flux of the LED module with respect of the initial one in function of the operating hours (50000)

Value B: it defines the percentage of LED modules that are below the specific value L, and that don't maintain the declared flux.

i.e. 50000 (h) L90 B10 means that, after the indicated operating hours, 10% of the modules have the luminous flux lower than 90% of the beginning one.

GRUPPI DI RISCHIO - RISK GROUPS



L'illuminazione a LED è classificata secondo la norma IEC/TR 62778.

Gli apparecchi SIDE rientrano nella categoria "Exempt Group" (assenza di pericoli legati all'infrarosso, alla luce blu e alla radiazione UV) garantendo il rispetto dei requisiti di sicurezza imposti dalla norma stessa (gruppo di rischio 0-1).









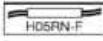

The LED lighting is classified according to the IEC/TR 62778 standard.

SIDE appliances belong to the category of "Exempt Group" (absence of dangers of infrared, blue light and UV radiation) ensuring the compliance with the safety regulations imposed by the above specification (risk group 0-1).

0 ESENTE nessun rischio fotobiologico.
FREE no photobiological risk.

1 RISCHIO BASSO nessun rischio fotobiologico nelle normali condizioni di impiego.
LOW RISK no photobiological hazard under normal conditions of use.

2 RISCHIO MODERATO non presenta rischio in condizioni di riflesso naturale di avversione alla luce o effetti termici.
MODERATE RISK it has no risk in case of natural reflex, light aversion or thermic effects.

	Rotazione asse verticale - Vertical axis rotation
	Rotazione-movimento asse orizzontale - Horizontal axis rotation-adjustability
	Orientamento - Orientation
	Dimensioni fori d'incasso in mm. - Cut-out dimensions in mm.
	Distanza minima tra lampada e oggetto illuminato Minimum distance between lamp and lightened object
	Spessore del controsoffitto - Thickness of false-ceiling
... (h) L. B.	Valori di vita dei moduli Led - Life value of Led module
SDCM	Deviazione standard della corrispondenza colore - Standard deviation of colour matching
	Cavo di alimentazione per collegamento elettrico - Power cable for electrical connection
	Gruppo di rischio fotobiologico - (rischio esente) - Photobiological risks group (risk free)
	Flicker free: Effetto di flickering minore o uguale al 3% - Flickering less or equal 3%
	Tecnologia per alimenti - Food technology
	Valore UGR con interdistanza di default 0,25 (tabelle CIE dell'indice unificato di abbagliamento) UGR value with default inter distance 0.25 (dazzle unified index CIE tables)
	Apparecchi non idonei ad essere ricoperti da materiale termicamente isolante Luminaires not suitable for covering with thermally insulating material
	Peso lordo - Gross weight
	Ampiezza fascio luminoso - Light beam wide
	Apparecchio in Classe I con terminale di messa a terra - Class I luminaire with earth terminal block
	Apparecchio in Classe II - Class II luminaire
	Apparecchio in Classe III - Class III luminaire
	Apparecchio che può essere installato su superfici infiammabili - Luminaire which can be mounted on inflammable surfaces
	Accenditore esterno - External ignitor
	Attenzione apparecchi sensibili alla elettrostaticità - Attention when handling led electrostatic sensitive devices
	Polipropilene - Polypropylene
	Filo incandescente a 850° C - Glowing wire 850° C
ACC.	Accessorio - Accessory
OP.	Opzionale - Optional
Se	Solo emergenza - Emergency only
Sa	Sempre acceso - Always on
	Equipaggiato con alimentazione di emergenza - Emergency equipped
	Alimentatore elettronico - Electronic driver
	Alimentatore dimmerabile - Dimmable driver
	Alimentatore elettromeccanico - Electromechanical driver
	Alimentatore protetto termicamente (max 100°C) - Thermal protected driver (max 100°C)
	Alimentatore installabile su mobili con caratteristiche d'infiammabilità non conosciute - Ballast can be installed on furniture with features of flash unknow
	Alimentatore indipendente installabile senza copertura aggiuntiva - Independent ballast can be installed without additional coverage
	Alimentatore protetto contro corti circuiti - Driver protected against short circuit
	Marchi di qualità - Quality marks
CE	Conformità con le seguenti leggi - Conformity with the following norms: CE 89/336 - CEE 93/68-73/23 CEE
	Adatto per installazioni in acqua fino a 3 m. di profondità Suitable for underwater applications max. depth 3 m.



Un sistema di gestione è un insieme di regole e di procedure, definito in una norma riconosciuta a livello internazionale, che un'organizzazione può applicare allo scopo di raggiungere obiettivi definiti quali, ad esempio, la soddisfazione del cliente ed il miglioramento continuo delle prestazioni. La certificazione dei sistemi di gestione è il riconoscimento delle capacità imprenditoriali di un'azienda che ha saputo ottimizzare la propria organizzazione dotandosi di una gestione efficiente, di strutture idonee e di competenze adeguate, ma è anche una garanzia di affidabilità per clienti, fornitori, dipendenti e collaboratori, tanto più valida tanto più è prestigioso l'ente che ha rilasciato la certificazione. CSQ è un marchio che identifica la conformità del Sistema di Gestione per la Qualità di un'organizzazione alle prescrizioni della normativa UNI EN ISO 9001:2000.

A management system is a set of rules and procedures, defined by an internationally recognized standard that a company may apply in order to reach defined objectives like, for example, the customer satisfaction and the continuous improvement of its performances. The management systems certification is the recognition of the entrepreneurial skills of a company that has been able to optimize its organization with an efficient management, suitable facilities and appropriate competences. It is also a reliability guarantee for the customers, the suppliers, the employees and the collaborators and of course its recognition depends on how prestigious the Entity that issues it. CSQ is a brand that identifies the conformity of the Management System for the Quality of an organization to the prescriptions of the UNI EN ISO 9001:2000 standard.



03
IQNet è il più grande network mondiale di organismi di certificazione operanti nel campo della certificazione dei sistemi di gestione per la qualità, ambiente, sicurezza e responsabilità sociale. Fondato nel 1990, vi aderiscono attualmente 38 organismi di certificazione operanti in più di 150 paesi con più di 350.000 certificati emessi in tutto il mondo. Lo scopo sociale di IQNet si sintetizza nel contribuire all'affermazione internazionale dei suoi membri che devono essere i leader nel mondo in termini di reputazione, credibilità e capacità di fornire servizi certificativi in ogni parte del globo. ICIM grazie a IQNet è in grado di garantire una certificazione con riconoscibilità in tutte le nazioni aderenti al network.

IQNet is the biggest world network of certification organizations operating in the field of the certification of the management system for the quality, the environment, the safety and the social responsibility. It was founded in 1990 and is composed of 38 certification organizations operating in more than 150 countries, with more than 350,000 certifications issued all over the world. IQNet social aim is to contribute to the international diffusion of its members that are world leaders as for reputation, credibility and capacity of giving certification services all over the world. ICIM, thanks to IQNet, is able to guarantee a certification recognizable in all nations adhering to the network.



Laboratorio per prove IP (Ingress Protection)
Camera climatizzata per prove termiche di esercizio degli apparecchi e prove di durata.

Apparecchiatura per prove IK (Grado di protezione delle custodie contro i danni meccanici).

Test Lab IP (Ingress Protection)
Heating Chamber to test the exercise temperature and the duration of the equipment.

Equipment for IK testing. (Case protection degree against mechanical damages).



COMUNICAZIONE IMPORTANTE

I lumen (lm) indicati nel catalogo sono valori "tipici" dei moduli LED, pertanto potrebbero subire variazioni dovute alla continua evoluzione della tecnologia.

Per dati sempre aggiornati vi invitiamo a visitarci su www.sidespa.it



Anticorrosione per tutti gli apparecchi da esterno (1000 ore in nebbia salina secondo norma CEI EN 60068-2-11).

Pressofusione in alluminio EN AB 47100.

IMPORTANT NOTICE

The lumen (lm) listed in the catalog are "typical" values of LED modules and may be subject to change due to the continuous evolving technology. For up-to-date informations, please visit us on www.sidespa.it

Anti-corrosion for all outdoor fittings (1000 hours in salt spray according to standard CEI EN 60068-2-11).

Die-cast aluminium EN AB 47100.



Le esportazioni dei beni verso la Russia, Kazakistan, Bielorussia, i paesi che nel 2010 si sono costituiti nella cosiddetta Unione Doganale Eurasiatica, devono rispondere ai requisiti dei nuovi Regolamenti tecnici, che definiscono gli standard di sicurezza dei prodotti per ottenere la certificazione EAC [Eurasian Certification].

The exports of products to Russia, Kazakhstan, Belorussia, countries that in 2010 constituted the so called Eurasian Customs Union, must meet the requirements of the new technical Regulations, that define the products safety standards to get EAC certification [Eurasian Certification].



Marchio che attesta l'adesione al programma di licenza Philips (Philips LED Luminaires and Retrofit Bulbs Licensing Program) e la possibilità di SIDE di utilizzare i brevetti Philips nell'ambito dell'illuminazione LED.

Brand that certifies the adhesion to Philips license program (Philips LED Luminaires and Retrofit Bulbs Licensing Program) and SIDE possibility to use Philips patents in the field of the LED lightning.



Su articoli selezionati disponibili per il mercato canadese e USA.
On selected items available for Canadian and Us market.



CERTIFICATO DI ORIGINE

La società SIDE S.p.A. - Via C. Cattaneo, 90 - Lissone (MB) dichiara sotto la propria responsabilità che tutta la propria gamma di apparecchi di illuminazione ed accessori sono sviluppati e prodotti nel proprio stabilimento di Lissone (MB) Italy

The company SIDE S.p.A. - Via C. Cattaneo, 90 - Lissone (MB) declares under his owner responsibility that its entire range of lighting fixtures and accessories are developed and produced at its plant in Lissone (MB) Italy

SIDE®

SIDE S.p.A. - Via C. Cattaneo, 90 - 20851 LISSONE (MB) - Italy - Tel. 039 2449001 r.a. - Fax 039 2459338
Sede legale: 20900 Monza (MI) - Via Italia 29 - Cap. Soc. int. Vers. 3.000.000 - Reg. Soc. Trib. di Monza n. 22545 - C.C.I.A.A. n. 1102034



LIGHTING MADE IN ITALY

COLORI SORGENTI LUMINOSE LED - LED LIGHTING SOURCE COLORS



LBI

Bianco freddo - Cool white (6000K)



LBC

Bianco caldo - Warm white (3000K)



LBN

Bianco neutro - Neutral white (4000K)



RGB

Multicolore - Multicolor



LBL

Blu - Blue



VT

Vetro trasparente - Transparent Glass



VS

Vetro Sabbiato - Frosted Glass



COLORI DI FINITURA - FINISHING COLOURS

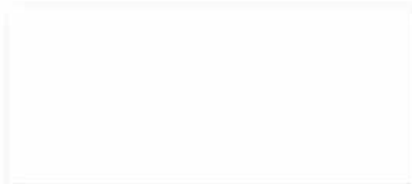

Br
RAL9010
Bianco raggrinzante - Rough white

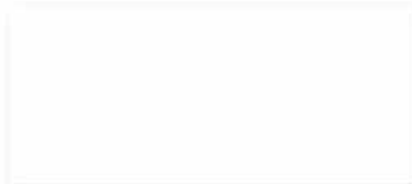

Bi
RAL9010
Bianco - White

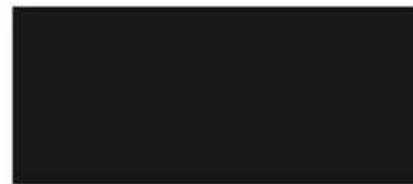

Ne
RAL 9005
Nero - Black

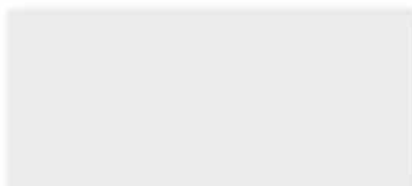

Ga-Gr
RAL 9006
Grigio raggrinzante - Rough grey



GrA
RAL 7016
Grigio Antracite - Grey anthracite



Bw
Marrone - Brown
AKZO NOBEL SAP 19805 SW 208G



Cr
Cromato - Chrome



Cm
Cromo - Matt chrome



Al
Alluminio - Aluminium



Als
Alluminio satinato - Satin aluminium



Inox
Acciaio Inox - Stainless steel Inox



Corten
Ruggine - Rusty
AKZO NOBEL YX355F



Ve
Verde - Green

PERSONALIZZAZIONE - CUSTOMIZATION



SIDE realizza le proprie linee di prodotto con 3 colorazioni standard; bianco, nero e grigio. Oltre a questi colori è possibile personalizzare i nostri prodotti con colorazioni dedicate in base alle diverse esigenze estetiche e progettuali. Grazie ai nostri processi di verniciatura con polveri epossidiche, siamo in grado di offrire una gamma colore che comprende tutti i codici della tabella RAL con una semplice richiesta scritta. SIDE, produce anche binari elettrificati verniciabili con i medesimi codici RAL.

SIDE realizes its lines of products in 3 standard colors: white, black and grey. Beside these colors, it is possible to customize our products according to the esthetical and design requests. Thanks to our painting processes with epoxy powders, we can offer a range of colors that includes all the codes of the RAL table, with a simple written request. SIDE produces also electrified rails that can be painted with the same RAL codes.

LOMBARDIA

SIMA LUCE SNC
Viale Borri, 57 - 21052 Busto Arsizio (VA)
Tel. +39 0331 673755
e-mail: info@simaluce.it

VENETO - TRENTINO - FRIULI V.G.

A.R.M.EL SNC Agenzia di rappresentanze
Via Fonderia, 8 - 31100 Treviso
Tel. +39 0422 1871772
e-mail: info@armelsnc.it
www.armelsnc.it

LIGURIA - PIEMONTE - VALLE D'AOSTA

SORIT COOP s.r.l.
Via Alberto Nota, 7 - 10122 Torino
Tel. +39 011 7397824
email: info@agsoritilluminaazione.com

EMILIA ROMAGNA - REPUBBLICA DI SAN MARINO

BATTAGLIOLI s.r.l.
Via Montecassino, 32/42 - 40050 Fano di Argelato (BO)
Tel. +39 051 860336 - Fax. +39 051 664640
e-mail: info@battaglioli.it

MARCHE - UMBRIA - ABRUZZO - MOLISE

R-INSIDE Light Solution Partner
Sede - Uffici e Show Room
Via D. Tramontani, 5 - 06135 Ponte San Giovanni (PG)
Tel. +39 075 396229 - Fax. +39 075 5990073
e-mail: rinside@relagenzia.com

TOSCANA

REL 2 SICUREZZA SNC
Via dei Ceramisti, 6/A - 50055 Lastra a Signa (FI)
Tel. +39 055 7224314
e-mail: rel2agenzia@rel2agenzia.com

LAZIO

UFFICIO di ROMA
Marco Di Censi - cell. +39 392 3153365
e-mail: marco.dicensi@sidespa.it

CAMPANIA - POTENZA e PROVINCIA

MAURO ETTARI
Via A. Omodei, 104 - 80128 Napoli
Tel. +39 335 6676558
e-mail: mauro@ettari.it

CALABRIA

SANTISE A. & C. SAS
Via Carcara, 9 - 88068 Soverato (CZ)
Tel. +39 0967 521483 - +39 0967 521421 - Fax +39 0967 819571
e-mail: agenzia@santiserappresentanze.it

PUGLIA - MATERA e PROVINCIA

Saverio Menolascina - cell. +39 370 3638282
Via G. De Marinis, 95 - 70131 Bari
e-mail: saverio.menolascina@sidespa.it

SICILIA ORIENTALE

Massimiliano Fiorentino - cell. +39 335 6552140
Via Nazionale 32 - 95020 Cannizzaro (CT)
Tel. +39 095 274008
e-mail: fiorentino.agenzia@libero.it
Consulenza illuminotecnica: Massimiliano Fiorentino

SICILIA OCCIDENTALE

ELETTROPROMOZIONI
di Giuseppe Basile - cell. +39 348 6705054
Via Gaetano Maria Pernice, 5 - 90149 Palermo
Tel. +39 091 6701076
e-mail: elettropromozioni@elettropromozioni.it
e-mail: giuseppebasile@elettropromozioni.it

SARDEGNA

Marco Di Censi - cell. +39 392 3153365
e-mail: marco.dicensi@sidespa.it



Via Cattaneo 90 - 20851 Lissone (MB)
 Tel. +39 039 2449001 - Fax. +39 039 2459338
 e-mail: info@sidespa.it - www.sidespa.it

Promotore tecnico

Luca Marzocchi
 Tel. +39 340 7258966
 e-mail: luca.marzocchi@battaglioli.it

SIDE Roma

Via dell'Industria snc - 00054 Fiumicino Roma
 Tel. +39 039 2449001 - Fax. +39 039 2459338
 e-mail: side.roma@sidespa.it

Responsabile per il Centro Sud Italia

Marco Di Censi - cell. +39 392 3153365
 e-mail: marco.dicensi@sidespa.it

KAM per il Sud Italia

Saverio Menolascina - cell. +39 370 3638282
 Via G. De Marinis, 95 - 70131 Bari
 e-mail: saverio.menolascina@sidespa.it

Art. 1. Prodotti

- 1.1 SIDE S.p.A. si riserva la facoltà di apportare, in qualunque momento e senza preavviso, modifiche nella costruzione degli apparecchi luminosi e degli accessori.

Art. 2. Dichiarazioni dell'acquirente

- 2.1 Ai fini di quanto previsto dall'art. 25 della Legge 06-02-1996 n° 52 di recepimento della direttiva CE n° 93-1993, relativa alle clausole vessatorie, l'acquirente dichiara che provvederà all'acquisto dei prodotti di SIDE S.p.A. agendo esclusivamente per fini che rientrano nella sua specifica attività professionale imprenditoriale e quindi dichiara di essere a conoscenza dei prodotti, servizi e prezzi offerti al momento della consegna.

Art. 3. Consegna

- 3.1 Il termine di consegna fissato convenzionalmente è soltanto indicativo e decorre, dall'invio da parte di SIDE S.p.A., della conferma d'ordine a condizione che l'acquirente abbia fornito tutti i dati tecnici e tutti i documenti necessari, abbia adempiuto a tutte le obbligazioni contrattuali ed abbia versato l'acconto eventualmente richiesto. La consegna, così come previsto dall'art. 13.1, si intende effettuata alla data di partenza franco spedizioniere.
- 3.2 SIDE S.p.A. produce e fornisce i prodotti su commessa senza vincolo di osservanza di termini di consegna tassativi. I termini di consegna pattuiti al momento degli ordini hanno valore puramente indicativo e gli eventuali ritardi non danno all'acquirente il diritto di chiedere l'annullamento, la rescissione o la risoluzione del contratto, né di rifiutare la merce, né di reclamare il risarcimento dei danni, salva preventiva diffida ad adempiere ai sensi e per gli effetti dell'art. 1454 c.c.
- 3.3 SIDE S.p.A. è liberata da ogni impegno e responsabilità relativo al termine di consegna e si riserva di risolvere il contratto, senza riconoscere danno alcuno, indennizzo, risarcimento all'acquirente, in caso di forza maggiore e di eventi al di fuori del ragionevole controllo di SIDE S.p.A. quali, a mero titolo esemplificativo e non esaustivo, lockout, epidemie, guerre, requisizioni, fuoco, incendi alle attrezzature, atti di nemici pubblici, sabotaggio, tumulti o sommosse civili, scioperi, serrate, controversie di lavoro, riduzione e/o interruzione totale o parziale dell'attività di SIDE S.p.A., embarghi o ritardi nei trasporti, mancanza o carenza di materiali, di fornitori o equipaggiamenti, inadempienze di fornitori, atti o regolamenti o provvedimenti di qualsiasi governo, sue branche o agenzie. SIDE S.p.A. informerà l'acquirente dei fatti ed avvenimenti sopra elencati.

Art. 4. Contestazioni

- 4.1 Il Foro di Monza è esclusivamente competente a decidere qualunque controversia dovesse insorgere tra le parti e in particolare quelle relative alle trattative contrattuali, alla conclusione, esecuzione, interpretazione, o risoluzione di tutti i contratti intervenuti ed alla relativa garanzia.

Art. 5. Esecuzioni speciali

- 5.1 È possibile ottenere colori fuori standard ed esecuzioni speciali in alcune serie di prodotti. Il prezzo, le quantità minime dei prodotti e i tempi di consegna verranno concordati su richiesta.

Art. 6. Garanzia

- 6.1 Ogni apparecchio viene garantito integralmente per la durata di 24 mesi con decorrenza dalla data di consegna per tutti i possibili difetti di fabbricazione, di materiale e per tutti i guasti non imputabili al cliente.
- 6.2 Sono esclusi dalla garanzia tutti i guasti dovuti a cause di forza maggiore (fulmine, incendio, etc.) nonché tutti i danni causati da un uso improprio dell'apparecchiatura. Sono altresì escluse dalla garanzia le batterie e gli accumulatori.
- 6.3 LA GARANZIA DECADE INDEROGABILMENTE IN CASO DI MANOMISSIONI DEGLI APPARECCHI DA PARTE DI PERSONE O TECNICI NON ESPRESSAMENTE AUTORIZZATI DALLA SIDE S.p.A.

Art. 7. Offerte

- 7.1 Il prezzo e le caratteristiche dei prodotti menzionati nei cataloghi, prospetti, documenti pubblicitari e le spese non vincolano SIDE S.p.A., la quale si riserva il diritto di apporvi, in qualsiasi momento, delle modifiche. Tutte le offerte si intendono non vincolanti; le condizioni economiche applicabili al rapporto saranno, pertanto, quelle risultanti dai listini di SIDE S.p.A. al momento della conclusione del contratto relativo alla fornitura dei beni all'acquirente.
- 7.2 Le offerte, gli allegati, i campioni, i disegni tecnici e le descrizioni rimangono di proprietà di SIDE S.p.A., non potranno essere utilizzate dal potenziale acquirente e dovranno essere immediatamente restituite a SIDE S.p.A. in caso di mancata stipulazione del contratto tra le parti e-o di incarico ad un altro soggetto diverso da SIDE S.p.A.
- 7.3 Poiché le caratteristiche dei prodotti venduti sono in continua evoluzione e perfezionamento, gli stessi sono suscettibili di essere modificati o ritirati dal commercio in qualsiasi momento e senza preavviso.
- 7.4 Gli agenti o preposti di SIDE S.p.A. non hanno il potere di vincolare quest'ultima, salvo conferma espressa per iscritto.

Art. 8. Ordini

- 8.1 Gli ordini dell'acquirente devono essere effettuati per iscritto e, se trattasi di persona giuridica, devono essere sottoscritti da persona all'uopo autorizzata ad impegnare la stessa. In ogni caso l'esistenza del potere di rappresentanza del sottoscrittore si presume a favore di SIDE S.p.A.
- 8.2 Ogni eventuale ordine telefonico dovrà essere confermato per iscritto. In difetto l'ordine si ritiene non pervenuto.
- 8.3 SIDE S.p.A. si riserva, in ogni caso, il diritto di richiedere, al momento dell'ordine da parte dell'acquirente, un acconto oppure il pagamento integrale anticipato della fornitura.
- 8.4 La conferma d'ordine dovrà essere effettuata per iscritto e dovrà pervenire direttamente a SIDE S.p.A. In ogni caso l'esecuzione dell'ordine da parte di SIDE S.p.A. equivale, ai sensi dell'art. 1327 c.c., ad accettazione.
- 8.5 L'ordinazione viene assunta SALVO APPROVAZIONE DELLA CASA ed è conferita irrevocabilmente per la durata di mesi uno data ordine (art. 1329 C.C.), nonché con richiesta di esecuzione senza preventiva risposta (art. 1327 C.C.).
- 8.6 Le ordinazioni dei nostri prodotti si intendono sempre accettate ai prezzi ed alle condizioni di vendita in vigore all'epoca della consegna della merce. A fronte di eventuale variazioni di listino e quindi di prezzi e condizioni, l'acquirente avrà la facoltà di annullare gli ordini in atto con lettera raccomandata entro 8 giorni dalla nostra comunicazione di variazioni.
- 8.7 Le ordinazioni, anche se raccolte tramite il nostro personale di vendita, si intendono subordinate alla accettazione di SIDE S.p.A., che può essere anche parziale.

Art. 9. Pagamento

- 9.1 Il pagamento deve essere effettuato entro il termine convenuto nel modo e col mezzo indicato nell'ordine e al domicilio del venditore (SIDE S.p.A.) e ciò anche nei casi di ritardo nell'arrivo della merce, o di avarie o perdite totali o parziali verificatesi durante il trasporto, nonché nel caso in cui le merci messe a disposizione dell'acquirente mediante consegna allo spedizioniere, non vengano dall'acquirente stesso ritirate.
- 9.2 La eventuale accettazione, da parte della venditrice, di tratte o di altri effetti di commercio si intenderà avvenuta con la clausola "salvo buon fine".

- 9.3** Sui pagamenti differiti anche cambiali, da SIDE S.p.A. preventivamente accettati, è in ogni caso dovuto l'interesse decorrente dalla data della fattura, secondo il tasso praticato dalle banche sugli scoperti di conto corrente vigente alla data di pagamento.
- 9.4** Eventuali sconti di cassa, nonché abbuoni o premi di qualsiasi natura saranno accordati a condizione che il cliente non abbia pagamenti in sospeso e si intenderanno automaticamente decaduti e revocati in caso di mancato pagamento.
- 9.5** In caso di ritardato pagamento alle scadenze prestabilite, verranno riconosciuti alla Società venditrice SIDE S.p.A. gli interessi bancari correnti PRIME RATE aumentati di 3 punti. L'inadempienza nei pagamenti relativi a più rate, od anche ad una sola che superi l'ottava parte del prezzo, farà decadere il compratore dal beneficio del termine rateale e darà diritto alla venditrice di richiedere subito il residuo saldo del prezzo, oppure di ritenere senz'altro risolto il contratto con restituzione immediata della merce ed acquisizione, a titolo di indennizzo, delle rate pagate, salvo, comunque, il risarcimento dei danni.
- 9.6** Per patto espresso tra le parti, qualunque contestazione fosse sollevata dalla parte acquirente o dovesse comunque sorgere tra le parti, non potrà sospendere l'obbligo dell'acquirente di provvedere al pagamento entro il termine pattuito.
- 9.7** La perdita delle apparecchiature e dei relativi accessori per causa non imputabile a SIDE S.p.A., non libera l'acquirente dall'obbligo del pagamento ancorché la merce non gli sia stata consegnata.

Art. 10. Riserva di proprietà

- 10.1** Le apparecchiature indicate in ordine ed i relativi accessori sono venduti con RISERVA DI PROPRIETA' a favore della venditrice SIDE S.p.A. e, quindi, il compratore ne acquisterà la proprietà soltanto al pagamento dell'ultima rata di prezzo, ma ne assume i rischi al momento della consegna (art. 1523 C.C.).
- 10.2** Qualora per opera di terzi venisse operato per opera di terzi un sequestro o un pignoramento, l'acquirente si impegna a far inserire, nel relativo verbale di esecuzione redatto dal precedente, la dichiarazione che proprietà in virtù di riservato dominio è SIDE S.p.A., e ad informare immediatamente la stessa perché possa agire in sede di opposizione di terzo a rituale rivendica, con diritto di rivalsa per tutte le spese relative.

Art. 11. Prezzi ed oneri fiscali

- 11.1** Sugli ordini verranno applicati i prezzi al pubblico riportati nel "listino prezzi", eventuali condizioni particolari dovranno essere pattuite ed autorizzate dalla SIDE S.p.A. in maniera scritta.
- 11.2** I prezzi applicati sono suscettibili di essere modificati sino alla conferma dell'ordine da parte di SIDE S.p.A. La modifica avviene in relazione alla variazione del rapporto di cambio, dei costi delle materie prime nonché di eventuali tasse o imposte applicabili al contratto.
- 11.3** Il prezzo definitivo, al netto delle tasse e/o imposte è quello riportato sulla conferma d'ordine di SIDE S.p.A. e si intende per merce resa franco spedizioniere.
- 11.4** I prezzi riportati nelle offerte e nel listino di SIDE S.p.A. non sono comprensivi di IVA, del costo di installazione e del costo delle lampadine. Eventuali altri costi, oneri o spese relative agli articoli offerti e non espressamente indicati nell'offerta o nel listino di SIDE S.p.A. sono comunque a carico dell'acquirente richiesti a parte. In relazione alla complessità della fornitura il servizio tecnico-commerciale di SIDE S.p.A. è a disposizione dell'acquirente per la definizione di costi e modalità.
- 11.5** Valgono inoltre le seguenti condizioni:
consegne franco fabbrica per ordini al valore netto inferiore a € 500 per l'Italia;
consegne franco destino per l'Italia per ordini di valore netto superiori a € 500 per l'Italia;
consegne EX-Works per l'estero.
- 11.6** Valore minimo fatturabile: € 150,00.

Art. 12. Reclami

- 12.1** Eventuali reclami per vizi o difetti della merce ci vanno comunicati con lettera raccomandata entro e non oltre 8 giorni dalla scoperta del difetto, sotto pena di decadenza di ogni azione di garanzia.
- 12.2** I prodotti difettosi, sempre che la relativa denuncia sia fatta tempestivamente, possono esserci restituiti, previa autorizzazione scritta, per effettuare le opportune riparazioni o sostituzioni escluso ogni altro nostro onere od obbligo o responsabilità.
- 12.3** Gli eventuali ritorni dovranno essere resi franchi in ogni spesa al nostro stabilimento di Lissone (MI); in ogni caso verrà accreditato un importo pari del valore della merce resa.

Art. 13. Trasporti

- 13.1** La merce viaggia sempre a rischio e pericolo dell'acquirente.
- 13.2** Qualora SIDE S.p.A. provveda a stipulare il contratto di trasporto con il vettore, agirà sempre per conto e con spese a carico dell'acquirente, con le conseguenze di cui all'art. 13.1. In tal caso, il prezzo dei prodotti sarà comprensivo dei costi del trasporto.
- 13.3** SIDE S.p.A. non è tenuta a concludere alcun contratto di assicurazione contro i rischi di trasporto.
- 13.4** In caso di avarie, rotture, furti o manomissioni della merce durante il trasporto o nel caso di ritardi di consegna imputabili allo spedizioniere e/o al vettore, l'acquirente potrà rivalersi nei confronti dello spedizioniere e/o del vettore incaricato, essendo esclusa qualsivoglia responsabilità di SIDE S.p.A. al riguardo.
- 13.5** Il cliente deve accertare peso e condizioni della merce all'atto della consegna.
- 13.6** SIDE S.p.A. si riserva la scelta del mezzo di trasporto, salvo pattuizione scritta contraria.

Art. 14. Vendita

- 14.1** La vendita, compresa la fase delle trattative, è regolata dal diritto italiano.

Art. 15. Conclusioni

- 15.1** Le presenti condizioni generali di vendita sono le sole applicabili nei rapporti tra SIDE S.p.A. e l'acquirente; in particolare è esclusa l'applicazione delle condizioni generali o particolari di contratto dell'acquirente, a meno che SIDE S.p.A. non le abbia accettate per iscritto.
- 15.2** Le parti espressamente dichiarano di escludere la applicazione della Convenzione di Vienna del 11-04-1980 (ratificata dallo Stato italiano con L. 11-12-1985 n° 765) in conformità a quanto previsto dall'art. 6 della stessa.
- 15.3** Per tutto quanto non previsto dalle presenti condizioni si applicano, ai singoli contratti, le norme sui contratti in generale (art. 1321 e ss.) e sul contratto di compravendita in particolare (art. 1470 e ss.) contemplate dal codice civile italiano.

**Non ci assumiamo responsabilità per errori di stampa.
La società si riserva il diritto di apportare modifiche sui prodotti qui illustrati, in qualsiasi momento, senza preavviso.
Sono vietate riproduzioni o copie senza autorizzazione.**

**We are not responsible for printing errors, wrong dimensions.
The company reserves the right to amend all products herein detailed, any time and without prior notice.
Unauthorized reproductions and copies are prohibited.**

COD.	PAG.	COD.	PAG.	COD.	PAG.	COD.	PAG.
0021COB	25	148-Q	103	26401	183	2820C-LBN-24	43
0021COB-54	25	152	85	26401-BUS	187	2820C-LBN-40	43
0021COB-Q	25	161	573	26402	183	2820-MLBC-25	45
0022COB	25	162	573	26402	183	2820-MLBC-40	45
0022COB-54	25	163	573	26402-BUS	187	2820-MLBI-25	45
0022COB-Q	25	170	359	26403	183	2820-MLBI-40	45
0023COB	25	171	359	26403	183	2820-MLBN-25	45
0023COB-54	25	173	266	26403-BUS	187	2820-MLBN-40	45
0023COB-Q	25	178	267	2815C-LBC-15	29	2820-RGB-10	43
0024COB	25	185	383	2815C-LBC-24	29	2820-RGB-30	43
0024COB-Q	25	185-C	381	2815C-LBC-40	29	2820-RGB-45	43
0025COB	25	186-3	439	2815C-LBN-15	29	2821C-LBC-15	43
0025COB-Q	25	186-5	451	2815C-LBN-24	29	2821C-LBC-24	43
116	29	186-5	457	2815C-LBN-40	29	2821C-LBC-40	43
117	29	186-6	379	2815-MLBC-25	33	2821C-LBN-15	43
119-06	495	186-7	379	2815-MLBC-40	33	2821C-LBN-24	43
119-07	495	189	448	2815-MLBN-25	33	2821C-LBN-40	43
119-19	495	25101	180	2815-MLBN-40	33	2821-MLBC-25	45
120	25	25101-BUS	184	2816C-LBC-15	29	2821-MLBC-40	45
120-CR	25	25102	180	2816C-LBC-24	29	2821-MLBI-25	45
122	69	25102-BUS	184	2816C-LBC-40	29	2821-MLBI-40	45
122	91	25103	180	2816C-LBN-15	29	2821-MLBN-25	45
1220-LBC	20	25103-BUS	184	2816C-LBN-24	29	2821-MLBN-40	45
1220-LBN	20	25201	180	2816C-LBN-40	29	2821-RGB-10	43
1220-Q-LBC	23	25201-BUS	184	2816-MLBC-25	33	2821-RGB-30	43
1220-Q-LBN	23	25202	180	2816-MLBC-40	33	2821-RGB-45	43
1221-LBC	20	25202-BUS	184	2816-MLBN-25	33	2825C-LBC-15	29
1221-LBN	20	25203	180	2816-MLBN-40	33	2825C-LBC-24	29
1221-Q-LBC	23	25203-BUS	184	2817C-LBC-15	29	2825C-LBC-40	29
1221-Q-LBN	23	25301	180	2817C-LBC-24	29	2825C-LBN-15	29
1222-LBC	20	25301-BUS	184	2817C-LBC-40	29	2825C-LBN-24	29
1222-LBN	20	25302	180	2817C-LBN-15	29	2825C-LBN-40	29
1222-Q-LBC	23	25302-BUS	183	2817C-LBN-24	29	2825-JLBC-25	35
1222-Q-LBN	23	25302-BUS	184	2817C-LBN-40	29	2825-JLBC-25K	35
1223-LBC	20	25303	180	2817-MLBC-25	33	2825-JLBC-40	35
1223-LBN	20	25303-BUS	184	2817-MLBC-40	33	2825-JLBC-40K	35
1223-Q-LBC	23	25401	180	2817-MLBN-25	33	2825-JLBN-25	35
1223-Q-LBN	23	25401-BUS	184	2817-MLBN-40	33	2825-JLBN-40	35
1224-LBC	20	25402	180	2818C-LBC-15	29	2825-MLBC-25	33
1224-LBN	20	25402-BUS	184	2818C-LBC-24	29	2825-MLBC-40	33
1224-Q-LBC	23	25403-BUS	184	2818C-LBC-40	29	2825-MLBN-25	33
1224-Q-LBN	23	25403	180	2818C-LBN-15	29	2825-MLBN-40	33
1225-LBC	20	26101	183	2818C-LBN-24	29	2825-RGB-10	31
1225-LBN	20	26101	183	2818C-LBN-40	29	2825-RGB-30	31
1225-Q-LBC	23	26102	183	2818-MLBC-25	33	2825-RGB-45	31
1225-Q-LBN	23	26102	183	2818-MLBC-40	33	2826C-LBC-15	29
1226-LBC	20	26103	183	2818-MLBN-25	33	2826C-LBC-24	29
1226-LBN	20	26103	183	2818-MLBN-40	33	2826C-LBC-40	29
1226-Q-LBC	23	26201	183	2819C-LBC-15	43	2826C-LBN-15	29
1226-Q-LBN	23	26201	183	2819C-LBC-24	43	2826C-LBN-24	29
1227-LBC	20	26201-BUS	187	2819C-LBC-40	43	2826C-LBN-40	29
1227-LBN	20	26202	183	2819C-LBN-15	43	2826-JLBC-25	35
1227-Q-LBC	23	26202	183	2819C-LBN-24	43	2826-JLBC-25K	35
1227-Q-LBN	23	26202-BUS	187	2819C-LBN-40	43	2826-JLBC-40	35
1228-LBC	21	26203	183	2819-MLBC-25	45	2826-JLBC-40K	35
1228-LBN	21	26203	183	2819-MLBC-40	45	2826-JLBN-25	35
1229-LBC	21	26203-BUS	187	2819-MLBI-25	45	2826-JLBN-40	35
1229-LBN	21	26301	183	2819-MLBI-40	45	2826-MLBC-25	33
1230-LBC	21	26301	183	2819-MLBN-25	45	2826-MLBC-40	33
1230-LBN	21	26301-BUS	187	2819-MLBN-40	45	2826-MLBN-25	33
1231-LBC	21	26302	183	2819-RGB-10	43	2826-MLBN-40	33
1231-LBN	21	26302	183	2819-RGB-30	43	2826-RGB-10	31
125	87	26302-BUS	187	2819-RGB-45	43	2826-RGB-30	31
126	87	26303	183	2820C-LBC-15	43	2826-RGB-45	31
130	283	26303	183	2820C-LBC-24	43	2827C-LBC-15	29
145	43	26303-BUS	187	2820C-LBC-40	43	2827C-LBC-24	29
148	468	26401	183	2820C-LBN-15	43	2827C-LBC-40	29

COD.	PAG.	COD.	PAG.	COD.	PAG.	COD.	PAG.
2827C-LBN-15	29	2880-LBN	47	2987-LBN	71	3143-BW	587
2827C-LBN-24	29	2880-LBN-P	214	2988-LBC	71	3143-GR	587
2827C-LBN-40	29	2881-LBC	47	2988-LBN	71	3143-NE	587
2827-MLBC-25	33	2881-LBC-P	214	2989-LBC	71	3143-VE	587
2827-MLBC-40	33	2881-LBN	47	2989-LBN	71	3144	585
2827-MLBN-25	33	2881-LBN-P	214	2990-LBC	71	3145	585
2827-MLBN-40	33	2885-LBC	49	2990-LBN	71	3146	585
2827-RGB-10	31	2885-LBC-P	215	2991-LBC	71	3147-BW	585
2827-RGB-30	31	2885-LBN	49	2991-LBN	71	3147-GR	585
2827-RGB-45	31	2885-LBN-P	215	2992-LBC	71	3147-NE	585
2828C-LBC-15	29	2886-LBC	49	2992-LBN	71	3147-VE	585
2828C-LBC-24	29	2886-LBC-P	215	2993-LBC	71	3148-BW	585
2828C-LBC-40	29	2886-LBN	49	2993-LBN	71	3148-GR	585
2828C-LBN-15	29	2886-LBN-P	215	3010	137	3148-NE	585
2828C-LBN-24	29	2887-LBC	49	3014-BR	136	3148-VE	585
2828C-LBN-40	29	2887-LBC-P	215	3014-NE	136	3149-BW	585
2828-MLBC-25	33	2887-LBN	49	3031-BR	137	3149-GR	585
2828-MLBC-40	33	2887-LBN-P	215	3031-BR	151	3149-NE	585
2828-MLBN-25	33	2890-LBC	51	3031-GA	137	3149-VE	585
2828-MLBN-40	33	2890-LBN	51	3031-NE	137	3150-BW	583
2828-RGB-10	31	2891C-LBC-15	41	3031-NE	354	3150-GR	583
2828-RGB-30	31	2891C-LBC-24	41	3035	121	3150-NE	583
2828-RGB-45	31	2891C-LBC-40	41	3036	121	3150-VE	583
2845-S	27	2891C-LBN-15	41	3079	136	3151-BW	583
2846-S	27	2891C-LBN-24	41	3079	353	3151-GR	583
2847-S	27	2891C-LBN-40	41	3079-1	136	3151-NE	583
2848-S	27	2892C-LBC-15	41	3079-2	136	3151-VE	583
2855-S	27	2892C-LBC-24	41	3112	156	3190-LBC	299
2856-S	27	2892C-LBC-40	41	3113	156	3190-LBC	303
2857-S	27	2892C-LBN-15	41	3114	76	3190-LBN	299
2858-S	27	2892C-LBN-24	41	3115	76	3191	303
2860-LBC	103	2892C-LBN-40	41	3116	156	3193	299
2860-LBC-P	197	2893C-LBC-15	41	3117	76	3194	299
2860-LBN	103	2893C-LBC-24	41	3118	156	320000	497
2860-LBN-P	197	2893C-LBC-40	41	3119	76	320001	495
2861-LBC	103	2893C-LBN-15	41	3120	156	3350-LBC-D14	310
2861-LBC-P	197	2893C-LBN-24	41	3121	76	3350-LBC-D19	310
2861-LBN	103	2893C-LBN-40	41	3122	156	3350-LBC-D28	310
2861-LBN-P	197	2929C-FH-FL	349	3123	76	3350-LBC-D9	310
2862-LBC	103	2929C-FH-S	349	3127	643	3350-LBC-DE14	311
2862-LBC-P	197	2929C-FH-WF	349	3129	586	3350-LBC-DE19	311
2862-LBN	103	2929C-FM-FL	349	3130	586	3350-LBC-DE28	311
2862-LBN-P	197	2929C-FM-S	349	3131	586	3350-LBC-DE9	311
2865-LBC	85	2929C-FM-WF	349	3133-BW	586	3350-LBN-D14	310
2865-LBN	85	2929C-FV-FL	349	3133-GR	586	3350-LBN-D19	310
2866-LBC	85	2929C-FV-S	349	3133-NE	586	3350-LBN-D28	310
2866-LBN	85	2929C-FV-WF	349	3133-VE	586	3350-LBN-D9	310
2868-LBC	102	2929C-GD-FL	349	3134-BW	586	3350-LBN-DE14	311
2868-LBC-P	195	2929C-GDP-FL	349	3134-GR	586	3350-LBN-DE19	311
2868-LBN	102	2929C-GDP-S	349	3134-NE	586	3350-LBN-DE28	311
2868-LBN-P	195	2929C-GDP-WF	349	3134-VE	586	3350-LBN-DE9	311
2869-LBC	102	2929C-GD-S	349	3136-BW	586	3351-LBC-D14	310
2869-LBC-P	195	2929C-GD-WF	349	3136-GR	586	3351-LBC-D19	310
2869-LBN	102	2929C-LBC-FL	69	3136-NE	586	3351-LBC-D28	310
2869-LBN-P	195	2929C-LBC-S	69	3136-VE	586	3351-LBC-D9	310
2870-LBC	102	2929C-LBC-WF	69	3137	583	3351-LBC-DE14	311
2870-LBC-P	195	2929C-LBN-FL	69	3138	587	3351-LBC-DE19	311
2870-LBN	102	2929C-LBN-S	69	3139	587	3351-LBC-DE28	311
2870-LBN-P	195	2929C-LBN-WF	69	3140	587	3351-LBC-DE9	311
2875-LBC	105	2929C-MT-FL	349	3141-BW	587	3351-LBN-D14	310
2875-LBN	105	2929C-MT-S	349	3141-GR	587	3351-LBN-D19	310
2876-LBC	105	2929C-MT-WF	349	3141-NE	587	3351-LBN-D28	310
2876-LBN	105	2985-LBC	71	3141-VE	587	3351-LBN-D9	310
2877-LBC	105	2985-LBN	71	3142-BW	587	3351-LBN-DE14	311
2877-LBN	105	2986-LBC	71	3142-GR	587	3351-LBN-DE19	311
2880-LBC	47	2986-LBN	71	3142-NE	587	3351-LBN-DE28	311
2880-LBC-P	214	2987-LBC	71	3142-VE	587	3351-LBN-DE9	311

COD.	PAG.	COD.	PAG.	COD.	PAG.	COD.	PAG.
3352-LBC-D14	310	3360-LBC-D9	314	3363-LBC-DE28	316	3380-LBN-D28	320
3352-LBC-D19	310	3360-LBC-DE14	316	3363-LBC-DE9	316	3380-LBN-D28B	320
3352-LBC-D28	310	3360-LBC-DE19	316	3363-LBN-D14	315	3380-LBN-D9	318
3352-LBC-D9	310	3360-LBC-DE28	316	3363-LBN-D19	315	3380-LBN-D9B	318
3352-LBC-DE14	311	3360-LBC-DE9	316	3363-LBN-D28	315	3380-LBN-DE14	321
3352-LBC-DE19	311	3360-LBN-D14	315	3363-LBN-D9	314	3380-LBN-DE19	321
3352-LBC-DE28	311	3360-LBN-D19	315	3363-LBN-DE14	316	3380-LBN-DE19	321
3352-LBC-DE9	311	3360-LBN-D28	315	3363-LBN-DE19	316	3380-LBN-DE28	321
3352-LBN-D14	310	3360-LBN-D9	314	3363-LBN-DE28	316	3380-LBN-DE9	321
3352-LBN-D19	310	3360-LBN-DE14	316	3363-LBN-DE9	316	3381BCD14-AS	319
3352-LBN-D28	310	3360-LBN-DE19	316	3364-LBC-A	317	3381BCD14AS-D	319
3352-LBN-D9	310	3360-LBN-DE28	316	3364LBCA-DA	317	3381BCD14B-DA	319
3352-LBN-DE14	311	3360-LBN-DE9	316	3364-LBC-AM	317	3381BCD19-AS	319
3352-LBN-DE19	311	3361BCD14-AS	315	3364LBCAM-DA	317	3381BCD19AS-D	319
3352-LBN-DE28	311	3361BCD14AS-D	315	3364-LBN-A	317	3381BCD19B-DA	319
3352-LBN-DE9	311	3361BCD19-AS	315	3364LBNA-DA	317	3381BCD28-AS	320
3353-LBC-D14	310	3361BCD19AS-D	315	3364-LBN-AM	317	3381BCD28AS-D	320
3353-LBC-D19	310	3361BCD28-AS	315	3364LBNAM-DA	317	3381BCD28B-DA	320
3353-LBC-D28	310	3361BCD28AS-D	315	3365-LBC-A	317	3381BCD9-AS	318
3353-LBC-D9	310	3361BCD9-AS	314	3365LBCA-DA	317	3381BCD9AS-D	318
3353-LBC-DE14	311	3361BCD9AS-D	314	3365-LBC-AM	317	3381BCD9B-DA	318
3353-LBC-DE19	311	3361BND14-AS	315	3365LBCAM-DA	317	3381BND14-AS	319
3353-LBC-DE28	311	3361BND14AS-D	315	3365-LBN-A	317	3381BND14AS-D	319
3353-LBC-DE9	311	3361BND19-AS	315	3365LBN-DA	317	3381BND14B-DA	319
3353-LBN-D14	310	3361BND19AS-D	315	3365-LBN-AM	317	3381BND19-AS	319
3353-LBN-D19	310	3361BND28-AS	315	3365LBNAM-DA	317	3381BND19AS-D	319
3353-LBN-D28	310	3361BND28AS-D	315	3380BCD14-AS	319	3381BND19B-DA	319
3353-LBN-D9	310	3361BND9-AS	314	3380BCD14AS-D	319	3381BND28-AS	320
3353-LBN-DE14	311	3361BND9AS-D	314	3380BCD14B-DA	319	3381BND28AS-D	320
3353-LBN-DE19	311	3361-LBC-D14	315	3380BCD19-AS	319	3381BND28B-DA	320
3353-LBN-DE28	311	3361-LBC-D19	315	3380BCD19AS-D	319	3381BND9-AS	318
3353-LBN-DE9	311	3361-LBC-D28	315	3380BCD19B-DA	319	3381BND9AS-D	318
3354-LBC-A	313	3361-LBC-D9	314	3380BCD28-AS	320	3381BND9B-DA	318
3354LBCA-DA	313	3361-LBC-DE14	316	3380BCD28AS-D	320	3381-LBC-D14	319
3354-LBC-AM	313	3361-LBC-DE19	316	3380BCD28B-DA	320	3381-LBC-D14B	319
3354LBCAM-DA	313	3361-LBC-DE28	316	3380BCD9-AS	318	3381-LBC-D19	319
3354-LBN-A	313	3361-LBC-DE9	316	3380BCD9AS-D	318	3381-LBC-D19B	319
3354LBNA-DA	313	3361-LBN-D14	315	3380BCD9B-DA	318	3381-LBC-D28	320
3354-LBN-AM	313	3361-LBN-D19	315	3380BND14-AS	319	3381-LBC-D28B	320
3354LBNAM-DA	313	3361-LBN-D28	315	3380BND14AS-D	319	3381-LBC-D9	318
3355-LBC-A	313	3361-LBN-D9	314	3380BND14B-DA	319	3381-LBC-D9B	318
3355LBCA-DA	313	3361-LBN-DE14	316	3380BND19-AS	319	3381-LBC-DE14	321
3355-LBC-AM	313	3361-LBN-DE19	316	3380BND19AS-D	319	3381-LBC-DE19	321
3355LBCAM-DA	313	3361-LBN-DE28	316	3380BND19B-DA	319	3381-LBC-DE19	321
3355-LBN-A	313	3361-LBN-DE9	316	3380BND28-AS	320	3381-LBC-DE28	321
3355LBNA-DA	313	3362-LBC-D14	315	3380BND28AS-D	320	3381-LBC-DE9	321
3355-LBN-AM	313	3362-LBC-D19	315	3380BND28B-DA	320	3381-LBN-D14	319
3355LBNAM-DA	313	3362-LBC-D28	315	3380BND9-AS	318	3381-LBN-D14B	319
3360BCD14-AS	315	3362-LBC-D9	314	3380BND9AS-D	318	3381-LBN-D19	319
3360BCD14AS-D	315	3362-LBC-DE14	316	3380BND9B-DA	318	3381-LBN-D19B	319
3360BCD19-AS	315	3362-LBC-DE19	316	3380-LBC-D14	319	3381-LBN-D28	320
3360BCD19AS-D	315	3362-LBC-DE28	316	3380-LBC-D14B	319	3381-LBN-D28B	320
3360BCD28-AS	315	3362-LBC-DE9	316	3380-LBC-D19	319	3381-LBN-D9	318
3360BCD28AS-D	315	3362-LBN-D14	315	3380-LBC-D19B	319	3381-LBN-D9B	318
3360BCD9-AS	314	3362-LBN-D19	315	3380-LBC-D28	320	3381-LBN-DE14	321
3360BCD9AS-D	314	3362-LBN-D28	315	3380-LBC-D28B	320	3381-LBN-DE19	321
3360BND14-AS	315	3362-LBN-D9	314	3380-LBC-D9	318	3381-LBN-DE19	321
3360BND14AS-D	315	3362-LBN-DE14	316	3380-LBC-D9B	318	3381-LBN-DE28	321
3360BND19-AS	315	3362-LBN-DE19	316	3380-LBC-DE14	321	3381-LBN-DE9	321
3360BND19AS-D	315	3362-LBN-DE28	316	3380-LBC-DE19	321	3382-LBC-D14	319
3360BND28-AS	315	3362-LBN-DE9	316	3380-LBC-DE19	321	3382-LBC-D19	319
3360BND28AS-D	315	3363-LBC-D14	315	3380-LBC-DE28	321	3382-LBC-D28	320
3360BND9-AS	314	3363-LBC-D19	315	3380-LBC-DE9	321	3382-LBC-D9	318
3360BND9AS-D	314	3363-LBC-D28	315	3380-LBN-D14	319	3382-LBC-DE14	321
3360-LBC-D14	315	3363-LBC-D9	314	3380-LBN-D14B	319	3382-LBC-DE28	321
3360-LBC-D19	315	3363-LBC-DE14	316	3380-LBN-D19	319	3382-LBC-DE9	321
3360-LBC-D28	315	3363-LBC-DE19	316	3380-LBN-D19B	319	3382-LBN-D14	319

INDICE CODICE PRODOTTI - PRODUCTS CODES INDEX

COD.	PAG.	COD.	PAG.	COD.	PAG.	COD.	PAG.
3382-LBN-D19	319	3417-840-DA	280	3730-LBN-P-DA	299	4152-LBC	109
3382-LBN-D28	320	3419-830	281	3730-LBN-S	303	4152-LBN	109
3382-LBN-D9	318	3419-830-DA	281	3730-LBN-S-DA	303	4162-LBC	109
3382-LBN-DE14	321	3419-840	281	3733-LBC-P	299	4162-LBN	109
3382-LBN-DE28	321	3419-840-DA	281	3733-LBC-P-DA	299	4194	107
3382-LBN-DE9	321	3420-830	281	3733-LBC-S	303	4195	107
3383-LBC-D14	319	3420-830-DA	281	3733-LBC-S-DA	303	4196	107
3383-LBC-D19	319	3420-840	281	3733-LBC-S-DA	303	4197	107
3383-LBC-D28	320	3420-840-DA	281	3733-LBN-P	299	4198	107
3383-LBC-D9	318	3421-830	281	3733-LBN-P-DA	299	4199	107
3383-LBC-DE14	321	3421-830-DA	281	3733-LBN-S	303	4200	107
3383-LBC-DE28	321	3421-840	281	3736-LBC-P	299	4201	107
3383-LBC-DE9	321	3421-840-DA	281	3736-LBC-P-DA	299	4430-LBC	296
3383-LBN-D14	319	3422-830	281	3736-LBC-S	303	4430-LBN	296
3383-LBN-D19	319	3422-830-DA	281	3736-LBC-S-DA	303	4432-LBC	296
3383-LBN-D28	320	3422-840	281	3736-LBN-P	299	4432-LBN	296
3383-LBN-D9	318	3422-840-DA	281	3736-LBN-P-DA	299	4433-LBC	296
3383-LBN-DE14	321	3424-830	279	3736-LBN-S	303	4433-LBN	296
3383-LBN-DE28	321	3424-830-DA	279	3736-LBN-S-DA	303	4434-LBC	296
3383-LBN-DE9	321	3424-840	279	3740-LBC-P	300	4434-LBN	296
3384-LBC-A	323	3424-840-DA	279	3740-LBC-P-DA	300	4435-LBC	296
3384-LBCA-DA	323	3425-830	279	3740-LBC-S	304	4435-LBN	296
3384-LBC-AM	323	3425-830-DA	279	3740-LBC-S-DA	304	4439-LBC	296
3384-LBCAM-DA	323	3425-840	279	3740-LBN-P	300	4439-LBN	296
3384-LBN-A	323	3425-840-DA	279	3740-LBN-P-DA	300	4440-LBC	296
3384-LBNA-DA	323	3426-830	279	3740-LBN-S	304	4440-LBN	296
3384-LBN-AM	323	3426-830-DA	279	3740-LBN-S-DA	304	4441-LBC	296
3384-LBNAM-DA	323	3426-840	279	3743-LBC-P	301	4441-LBN	296
3385-LBC-A	323	3426-840-DA	279	3743-LBC-P-DA	301	4442	296
3385-LBCA-DA	323	3427-830	279	3743-LBC-S	304	4444	296
3385-LBC-AM	323	3427-830-DA	279	3743-LBC-S-DA	304	4445-LBC	167
3385-LBCAM-DA	323	3427-840	279	3743-LBN-P	301	4445-LBC-DA	167
3385-LBN-A	323	3427-840-DA	279	3743-LBN-P-DA	301	4445-LBN	167
3385-LBNA-DA	323	3429-830	279	3743-LBN-S	304	4445-LBN-DA	167
3385-LBN-AM	323	3429-830-DA	279	3743-LBN-S-DA	304	4446-LBC	167
3385-LBNAM-DA	323	3429-840	279	3746-LBC-P	301	4446-LBC-DA	167
3409-830	280	3429-840-DA	279	3746-LBC-P-DA	301	4446-LBN	167
3409-830-DA	280	3430-830	279	3746-LBC-S	305	4446-LBN-DA	167
3409-840	280	3430-830-DA	279	3746-LBC-S-DA	305	4447-LBC	167
3409-840-DA	280	3430-840	279	3746-LBN-P	301	4447-LBC-DA	167
3410-830	280	3430-840-DA	279	3746-LBN-P-DA	301	4447-LBN	167
3410-830-DA	280	3431-830	279	3746-LBN-S	305	4447-LBN-DA	167
3410-840	280	3431-830-DA	279	3746-LBN-S-DA	305	4448-LBC	167
3410-840-DA	280	3431-840	279	406207	649	4448-LBC-DA	167
3411-830	280	3431-840-DA	279	406208	649	4448-LBN	167
3411-830-DA	280	3432-830	279	406219	649	4448-LBN-DA	167
3411-840	280	3432-830-DA	279	406259	649	4449-LBC	167
3411-840-DA	280	3432-840	279	406307	649	4449-LBC-DA	167
3412-830	280	3432-840-DA	279	406308	649	4449-LBN	167
3412-830-DA	280	3443	337	406319	649	4449-LBN-DA	167
3412-840	280	3444	337	406359	649	4450-LBC	167
3412-840-DA	280	359100	183	406407	647	4450-LBC-DA	167
3414-830	280	3710-LBC	117	406407	649	4450-LBN	167
3414-830-DA	280	3710-LBN	117	406408	647	4450-LBN-DA	167
3414-840	280	3716-LBC	117	406408	649	4451-LBC	167
3414-840-DA	280	3716-LBN	117	406419	647	4451-LBC-DA	167
3415-830	280	3719-LBC	117	406419	649	4451-LBN	167
3415-830-DA	280	3719-LBN	117	406459	649	4451-LBN-DA	167
3415-840	280	3722-LBC	117	4071	649	4452-LBC	167
3415-840-DA	280	3722-LBN	117	4073	643	4452-LBC-DA	167
3416-830	280	3725-LBC	117	4074	645	4452-LBN	167
3416-830-DA	280	3725-LBN	117	409500	230	4452-LBN-DA	167
3416-840	280	3730-LBC-P	299	409600	163	4455-LBC	115
3416-840-DA	280	3730-LBC-P-DA	299	409700	229	4455-LBC-DA	115
3417-830	280	3730-LBC-S	303	409800	231	4455-LBC-EM	115
3417-830-DA	280	3730-LBC-S-DA	303	409900	233	4455-LBN	115
3417-840	280	3730-LBN-P	299	409995	243	4455-LBN-DA	115

COD.	PAG.	COD.	PAG.	COD.	PAG.	COD.	PAG.
4455-LBN-EM	115	4469-LBC	273	4482-LBC-DA	275	5404-LBN	263
4456-LBC	115	4469-LBC-DA	273	4482-LBC-EM	275	5404-LBN-DA	263
4456-LBC-DA	115	4469-LBC-EM	273	4482-LBN	275	5405-LBC	263
4456-LBC-EM	115	4469-LBN	273	4482-LBN-DA	275	5405-LBC-DA	263
4456-LBN	115	4469-LBN-DA	273	4482-LBN-EM	275	5405-LBN	263
4456-LBN-DA	115	4469-LBN-EM	273	5401-FH-30	363	5405-LBN-DA	263
4456-LBN-EM	115	4470-LBC	273	5401-FH-60	363	5406-LBC	263
4457-LBC	115	4470-LBC-DA	273	5401-FM-30	363	5406-LBC-DA	263
4457-LBC-DA	115	4470-LBC-EM	273	5401-FM-60	363	5406-LBN	263
4457-LBC-EM	115	4470-LBN	273	5401-FV-30	363	5406-LBN-DA	263
4457-LBN	115	4470-LBN-DA	273	5401-FV-60	363	5407-FH	365
4457-LBN-DA	115	4470-LBN-EM	273	5401-GD-30	363	5407-FM	365
4457-LBN-EM	115	4471-LBC	273	5401-GD-60	363	5407-FV	365
4458-LBC	115	4471-LBC-DA	273	5401-GDP-30	363	5407-GD	365
4458-LBC-DA	115	4471-LBC-EM	273	5401-GDP-60	363	5407-GDP	365
4458-LBC-EM	115	4471-LBN	273	5401-LBC-30	261	5407-LBC	263
4458-LBN	115	4471-LBN-DA	273	5401LBC30-DA	261	5407-LBC-DA	263
4458-LBN-DA	115	4471-LBN-EM	273	5401-LBC-60	261	5407-LBN	263
4458-LBN-EM	115	4472-LBC	273	5401LBC60-DA	261	5407-LBN-DA	263
4459-LBC	115	4472-LBC-DA	273	5401-LBN-30	261	5407-MT	365
4459-LBC-DA	115	4472-LBC-EM	273	5401LBN30-DA	261	5408-FH	365
4459-LBC-EM	115	4472-LBN	273	5401-LBN-60	261	5408-FM	365
4459-LBN	115	4472-LBN-DA	273	5401LBN60-DA	261	5408-FV	365
4459-LBN-DA	115	4472-LBN-EM	273	5401-MT-30	363	5408-GD	365
4459-LBN-EM	115	4475-LBC	275	5401-MT-60	363	5408-GDP	365
4460-LBC	115	4475-LBC-DA	275	5402-FH-30	363	5408-LBC	263
4460-LBC-DA	115	4475-LBC-EM	275	5402-FH-60	363	5408-LBC-DA	263
4460-LBC-EM	115	4475-LBN	275	5402-FM-30	363	5408-LBN	263
4460-LBN	115	4475-LBN-DA	275	5402-FM-60	363	5408-LBN-DA	263
4460-LBN-DA	115	4475-LBN-EM	275	5402-FV-30	363	5408-MT	365
4460-LBN-EM	115	4476-LBC	275	5402-FV-60	363	5409-FH	365
4461-LBC	115	4476-LBC-DA	275	5402-GD-30	363	5409-FM	365
4461-LBC-DA	115	4476-LBC-EM	275	5402-GD-60	363	5409-FV	365
4461-LBC-EM	115	4476-LBN	275	5402-GDP-30	363	5409-GD	365
4461-LBN	115	4476-LBN-DA	275	5402-GDP-60	363	5409-GDP	365
4461-LBN-DA	115	4476-LBN-EM	275	5402-LBC-30	261	5409-LBC	263
4461-LBN-EM	115	4477-LBC	275	5402LBC30-DA	261	5409-LBC-DA	263
4462-LBC	115	4477-LBC-DA	275	5402-LBC-60	261	5409-LBN	263
4462-LBC-DA	115	4477-LBC-EM	275	5402LBC60-DA	261	5409-LBN-DA	263
4462-LBC-EM	115	4477-LBN	275	5402-LBN-30	261	5409-MT	365
4462-LBN	115	4477-LBN-DA	275	5402LBN30-DA	261	5413-FH	361
4462-LBN-DA	115	4477-LBN-EM	275	5402-LBN-60	261	5413-FM	361
4462-LBN-EM	115	4478-LBC	275	5402LBN60-DA	261	5413-FV	361
4465-LBC	273	4478-LBC-DA	275	5402-MT-30	363	5413-GD	361
4465-LBC-DA	273	4478-LBC-EM	275	5402-MT-60	363	5413-GDP	361
4465-LBC-EM	273	4478-LBN	275	5403-FH-30	363	5413-LBC	267
4465-LBN	273	4478-LBN-DA	275	5403-FH-60	363	5413-LBN	267
4465-LBN-DA	273	4478-LBN-EM	275	5403-FM-30	363	5413-MT	361
4465-LBN-EM	273	4479-LBC	275	5403-FM-60	363	5445-FH	360
4466-LBC	273	4479-LBC-DA	275	5403-FV-30	363	5445-FM	360
4466-LBC-DA	273	4479-LBC-EM	275	5403-FV-60	363	5445-FV	360
4466-LBC-EM	273	4479-LBN	275	5403-GD-30	363	5445-GD	360
4466-LBN	273	4479-LBN-DA	275	5403-GD-60	363	5445-LBC	266
4466-LBN-DA	273	4479-LBN-EM	275	5403-GDP-30	363	5445-LBI	266
4466-LBN-EM	273	4480-LBC	275	5403-GDP-60	363	5445-MT	360
4467-LBC	273	4480-LBC-DA	275	5403-LBC-30	261	5485-LBC	236
4467-LBC-DA	273	4480-LBC-EM	275	5403LBC30-DA	261	5485-LBC-DA	237
4467-LBC-EM	273	4480-LBN	275	5403-LBC-60	261	5485-LBC-DIM	236
4467-LBN	273	4480-LBN-DA	275	5403LBC60-DA	261	5485-LBC-EM1	236
4467-LBN-DA	273	4480-LBN-EM	275	5403-LBN-30	261	5485-LBN	236
4467-LBN-EM	273	4481-LBC	275	5403LBN30-DA	261	5485-LBN-DA	237
4468-LBC	273	4481-LBC-DA	275	5403-LBN-60	261	5485-LBN-DIM	236
4468-LBC-DA	273	4481-LBC-EM	275	5403LBN60-DA	261	5485-LBN-EM1	236
4468-LBC-EM	273	4481-LBN	275	5403-MT-30	363	5485P-LBC	230
4468-LBN	273	4481-LBN-DA	275	5403-MT-60	363	5485P-LBC-DA	230
4468-LBN-DA	273	4481-LBN-EM	275	5404-LBC	263	5485P-LBC-DIM	230
4468-LBN-EM	273	4482-LBC	275	5404-LBC-DA	263		

INDICE CODICE PRODOTTI · PRODUCTS CODES INDEX

■■■■ COD.	PAG.	■■■■ COD.	PAG.	■■■■ COD.	PAG.	■■■■ COD.	PAG.
5485P-LBC-EM1	230	5491P-LBN	231	5498-LBC-DA	241	5505P-LBC-DIM	228
5485P-LBN	230	5491P-LBN-DIM	231	5498-LBC-EM1	240	5505P-LBC-EM1	228
5485P-LBN-DA	230	5491P-LBN-EM1	231	5498-LBN	240	5505P-LBN	228
5485P-LBN-DIM	230	5491P-LBN-DA	231	5498-LBN-DA	241	5505P-LBN-DA	228
5485P-LBN-EM1	230	5492-LBC	238	5498-LBN-EM1	240	5505P-LBN-DIM	228
5486-LBC	236	5492-LBC-DA	239	5498P-LBC	233	5505P-LBN-EM1	228
5486-LBC-DA	237	5492-LBC-DIM	238	5498P-LBC-DA	233	5506EU-LBC	163
5486-LBC-DIM	236	5492-LBC-EM1 1H	238	5498P-LBC-EM1	233	5506EU-LBN	163
5486-LBC-EM1	236	5492-LBN	238	5498P-LBN	233	5506-LBC	234
5486-LBN	236	5492-LBN-DA	239	5498P-LBN-DA	233	5506-LBC-DA	234
5486-LBN-DA	237	5492-LBN-DIM	238	5498P-LBN-EM1	233	5506-LBC-DIM	234
5486-LBN-DIM	236	5492-LBN-EM1 1H	238	5499-LBC	240	5506-LBC-EM1	234
5486-LBN-EM1	236	5492P-LBC	231	5499-LBC-DA	241	5506-LBN	234
5486P-LBC	230	5492P-LBC-DIM	231	5499-LBC-EM1	240	5506-LBN-DA	234
5486P-LBC-DA	230	5492P-LBC-DA	231	5499-LBN	240	5506-LBN-DIM	234
5486P-LBC-DIM	230	5492P-LBC-EM1	231	5499-LBN-DA	241	5506-LBN-EM1	234
5486P-LBC-EM1	230	5492P-LBN	231	5499-LBN-EM1	240	5506P-LBC	228
5486P-LBN	230	5492P-LBN-DIM	231	5499P-LBC	233	5506P-LBC-DA	228
5486P-LBN-DA	230	5492P-LBN-DA	231	5499P-LBC-DA	233	5506P-LBC-DIM	228
5486P-LBN-DIM	230	5492P-LBN-EM1	231	5499P-LBC-EM1	233	5506P-LBC-EM1	228
5486P-LBN-EM1	230	5493-LBC	238	5499P-LBN	233	5506P-LBN	228
5487-LBC	236	5493-LBC-DA	239	5499P-LBN-DA	233	5506P-LBN-DA	228
5487-LBC-DA	237	5493-LBC-DIM	238	5499P-LBN-EM1	233	5506P-LBN-DIM	228
5487-LBC-DIM	236	5493-LBC-EM1	238	5500-LBC	240	5506P-LBN-EM1	228
5487-LBC-EM1	236	5493-LBN	238	5500-LBC-DA	241	5507EU-LBC	163
5487-LBN	236	5493-LBN-DA	239	5500-LBN	240	5507EU-LBN	163
5487-LBN-DA	237	5493-LBN-EM1	238	5500-LBN-DA	241	5507-LBC	234
5487-LBN-DIM	236	5493P-LBC	231	5501-LBC	240	5507-LBC-DA	234
5487-LBN-EM1	236	5493P-LBC-DIM	231	5501-LBC-DA	241	5507-LBC-DIM	234
5487P-LBC	230	5493P-LBC-DA	231	5501-LBN	240	5507-LBC-EM1	234
5487P-LBC-DA	230	5493P-LBC-EM1	231	5501-LBN-DA	241	5507-LBN	234
5487P-LBC-DIM	230	5493P-LBN	231	5502-LBC	240	5507-LBN-DA	234
5487P-LBC-EM1	230	5493P-LBN-DIM	231	5502-LBC-DA	241	5507-LBN-DIM	234
5487P-LBN	230	5493P-LBN-EM1	231	5502-LBN	240	5507-LBN-EM1	234
5487P-LBN-DA	230	5494-LBC	238	5502-LBN-DA	241	5507P-LBC	228
5487P-LBN-DIM	230	5494-LBC-DA	239	5503-LBC	97	5507P-LBC-DA	228
5487P-LBN-EM1	230	5494-LBC-DIM	238	5503-LBC-DA	97	5507P-LBC-DIM	228
5488-LBC	236	5494-LBN	238	5503-LBC-DIM	97	5507P-LBC-EM1	228
5488-LBC-DA	237	5494-LBN-DA	239	5503-LBC-EM1	97	5507P-LBN	228
5488-LBC-DIM	236	5494-LBN-EM1	238	5503-LBC-EM3	97	5507P-LBN-DA	228
5488-LBN	236	5495-LBC	238	5503-LBN	97	5507P-LBN-DIM	228
5488-LBN-DA	237	5495-LBC-DA	239	5503-LBN-DA	97	5507P-LBN-EM1	228
5488-LBN-DIM	236	5495-LBC-DIM	238	5503-LBN-DIM	97	5508-LBC	99
5488-LBN-EM1	236	5495-LBN	238	5503-LBN-EM1	97	5508-LBC-DA	99
5488-LBN-EM1	236	5495-LBN-DA	239	5503-LBN-EM3	97	5508-LBC-DIM	99
5489-LBC	236	5495-LBN-DIM	238	5504-LBC	97	5508-LBC-EM1	99
5489-LBC-DA	237	5496-LBC	238	5504-LBC-DA	97	5508-LBC-EM3	99
5489-LBC-DIM	236	5496-LBC-DA	239	5504-LBC-DIM	97	5508-LBN	99
5489-LBN	236	5496-LBC-DIM	238	5504-LBC-EM1	97	5508-LBN-DA	99
5489-LBN-DA	237	5496-LBN	238	5504-LBC-EM3	97	5508-LBN-DIM	99
5489-LBN-DIM	236	5496-LBN-DA	239	5504-LBN	97	5508-LBN-EM1	99
5490-LBC	236	5496-LBN-DIM	238	5504-LBN-DA	97	5508-LBN-EM3	99
5490-LBC-DA	237	5497-LBC	240	5504-LBN-DIM	97	5513EU-LBC	163
5490-LBC-DIM	236	5497-LBC-DA	241	5504-LBN-EM1	97	5513EU-LBN	163
5490-LBN	236	5497-LBC-EM1	240	5504-LBN-EM3	97	5513-LBC	235
5490-LBN-DA	237	5497-LBN	240	5505EU-LBC	163	5513-LBC-DA	235
5490-LBN-DIM	236	5497-LBN-DA	241	5505EU-LBN	163	5513-LBC-DIM	235
5491-LBC	238	5497-LBN-EM1	240	5505-LBC	234	5513-LBC-EM1	235
5491-LBC-DA	239	5497P-LBC	233	5505-LBC-DA	234	5513-LBN	235
5491-LBC-DIM	238	5497P-LBC-DA	233	5505-LBC-DIM	234	5513-LBN-DA	235
5491-LBC-EM1	238	5497P-LBC-EM1	233	5505-LBN	234	5513-LBN-DIM	235
5491-LBN	238	5497P-LBN	233	5505-LBN-DA	234	5513-LBN-EM1	235
5491-LBN-DA	239	5497P-LBN-DA	233	5505-LBN-DIM	234	5513P-LBC	229
5491-LBN-DIM	238	5497P-LBN-EM1	233	5505-LBN-EM1	234	5513P-LBC-DA	229
5491-LBN-EM1	238	5497P-LBN-EM1	233	5505P-LBC	228	5513P-LBC-DIM	229
5491P-LBC	231	5498-LBC	240	5505P-LBC-DA	228	5513P-LBC-EM1	229
5491P-LBC-DA	231					5513P-LBN	229
5491P-LBC-DIM	231						
5491P-LBC-EM1	231						

COD.	PAG.	COD.	PAG.	COD.	PAG.	COD.	PAG.
5513P-LBN-DA	229	5526-LBN	243	555212132	184	5565-LBC-DA-S	247
5513P-LBN-DIM	229	5526-LBN-DA	243	555212141	184	5565-LBC-DIM	243
5513P-LBN-EM1	229	5526-LBN-DA-S	247	555212142	184	5565LBC-DIM-S	247
5514EU-LBC	163	5526-LBN-DIM	243	555212151	184	5565-LBC-S	247
5514EU-LBN	163	5526-LBN-DIM-S	247	555212152	184	5565-LBN	243
5514-LBC	235	5526-LBN-S	247	555212161	184	5565-LBN-DA	243
5514-LBC-DA	235	5527-LBC	243	555212162	184	5565-LBN-DA-S	247
5514-LBC-DIM	235	5527-LBC-DA	243	555232011	187	5565-LBN-DIM	243
5514-LBC-EM1	235	5527-LBC-DA-S	247	555232012	187	5565LBN-DIM-S	247
5514-LBN	235	5527-LBC-DIM	243	555232021	187	5565-LBN-S	247
5514-LBN-DA	235	5527-LBC-DIM-S	247	555232022	187	5566-LBC	243
5514-LBN-DIM	235	5527-LBC-S	247	555232061	187	5566-LBC-DA	243
5514-LBN-EM1	235	5527-LBN	243	555232062	187	5566-LBC-DA-S	247
5514P-LBC	229	5527-LBN-DA	243	555232091	187	5566-LBC-DIM	243
5514P-LBC-DA	229	5527-LBN-DA-S	247	555232092	187	5566LBC-DIM-S	247
5514P-LBC-DIM	229	5527-LBN-DIM	243	555232101	187	5566-LBC-S	247
5514P-LBC-EM1	229	5527-LBN-DIM-S	247	555232102	187	5566-LBN	243
5514P-LBN	229	5527-LBN-S	247	555232121	187	5566-LBN-DA	243
5514P-LBN-DA	229	5535-LBC	244	555232122	187	5566-LBN-DA-S	247
5514P-LBN-DIM	229	5535-LBC-DA	244	555232131	187	5566-LBN-DIM	243
5514P-LBN-EM1	229	5535-LBC-DA-S	248	555232132	187	5566LBN-DIM-S	247
5515EU-LBC	163	5535-LBC-DIM	244	555232141	187	5566-LBN-S	247
5515EU-LBN	163	5535LBC-DIM-S	248	555232142	187	5567-LBC	243
5515-LBC	235	5535-LBC-S	248	555232151	187	5567-LBC-DA	243
5515-LBC-DA	235	5535-LBN	244	555232152	187	5567-LBC-DA-S	247
5515-LBC-DIM	235	5535-LBN-DA	244	555232161	187	5567-LBC-DIM	243
5515-LBC-EM1	235	5535-LBN-DA-S	248	555232162	187	5567LBC-DIM-S	247
5515-LBN	235	5535-LBN-DIM	244	555252031	187	5567-LBC-S	247
5515-LBN-DA	235	5535LBN-DIM-S	248	555255032	187	5567-LBN	243
5515-LBN-DIM	235	5535-LBN-S	248	5555-LBC	245	5567-LBN-DA	243
5515-LBN-EM1	235	5536-LBC	244	5555-LBC-DA	245	5567-LBN-DA-S	247
5515P-LBC	229	5536-LBC-DA	244	5555-LBC-DA-S	249	5567-LBN-DIM	243
5515P-LBC-DA	229	5536-LBC-DA-S	248	5555-LBC-DIM	245	5567LBN-DIM-S	247
5515P-LBC-DIM	229	5536-LBC-DIM	244	5555LBC-DIM-S	249	5567-LBN-S	247
5515P-LBC-EM1	229	5536LBC-DIM-S	248	5555-LBC-S	249	5583-FH	359
5515P-LBN	229	5536-LBC-S	248	5555-LBN	245	5583-FM	359
5515P-LBN-DA	229	5536-LBN	244	5555-LBN-DA	245	5583-FV	359
5515P-LBN-DIM	229	5536-LBN-DA	244	5555-LBN-DA-S	249	5583-GD	359
5515P-LBN-EM1	229	5536-LBN-DA-S	248	5555-LBN-DIM	245	5583-GDP	359
5516-LBC	99	5536-LBN-DIM	244	5555LBN-DIM-S	249	5583-MT	359
5516-LBC-DA	99	5536LBN-DIM-S	248	5555-LBN-S	249	5585-FH	359
5516-LBC-DIM	99	5536-LBN-S	248	5556-LBC	245	5585-FM	359
5516-LBC-EM1	99	5537-LBC	244	5556-LBC-DA	245	5585-FV	359
5516-LBC-EM3	99	5537-LBC-DA	244	5556-LBC-DA-S	249	5585-GD	359
5516-LBN	99	5537-LBC-DA-S	248	5556-LBC-DIM	245	5585-GDP	359
5516-LBN-DA	99	5537-LBC-DIM	244	5556LBC-DIM-S	249	5585-MT	359
5516-LBN-DIM	99	5537LBC-DIM-S	248	5556-LBC-S	249	5600-LBC2	251
5516-LBN-EM1	99	5537-LBC-S	248	5556-LBN	245	5600-LBC-DA2	251
5516-LBN-EM3	99	5537-LBN	244	5556-LBN-DA	245	5600-LBC-DIM2	251
5525-LBC	243	5537-LBN-DA	244	5556-LBN-DA-S	249	5600-LBC-EM2	251
5525-LBC-S	247	5537-LBN-DA-S	248	5556-LBN-DIM	245	5600-LBN2	251
5525-LBC-DA	243	5537-LBN-DIM	244	5556LBN-DIM-S	249	5600-LBN-DA2	251
5525-LBC-DA-S	247	5537LBN-DIM-S	248	5556-LBN-S	249	5600-LBN-DIM2	251
5525-LBC-DIM	243	5537-LBN-S	248	5557-LBC	245	5600-LBN-EM2	251
5525-LBC-DIM-S	247	555212011	184	5557-LBC-DA	245	5601-LBC2	251
5525-LBN	243	555212012	184	5557-LBC-DA-S	249	5601-LBC-DA2	251
5525-LBN-DA	243	555212021	184	5557-LBC-DIM	245	5601-LBC-DIM2	251
5525-LBN-DA-S	247	555212022	184	5557LBC-DIM-S	249	5601-LBC-EM2	251
5525-LBN-DIM	243	555212061	184	5557-LBC-S	249	5601-LBN2	251
5525-LBN-DIM-S	247	555212062	184	5557-LBN	245	5601-LBN-DA2	251
5525-LBN-S	247	555212091	184	5557-LBN-DA	245	5601-LBN-DIM2	251
5526-LBC	243	555212092	184	5557-LBN-DA-S	249	5601-LBN-EM2	251
5526-LBC-DA	243	555212101	184	5557-LBN-DIM	245	5602-LBC2	251
5526-LBC-DA-S	247	555212102	184	5557LBN-DIM-S	249	5602-LBC-DA2	251
5526-LBC-DIM	243	555212121	184	5557-LBN-S	249	5602-LBC-DIM2	251
5526-LBC-DIM-S	247	555212122	184	5565-LBC	243	5602-LBC-EM2	251
5526-LBC-S	247	555212131	184	5565-LBC-DA	243	5602-LBN2	251

■■■■ COD.	PAG.	■■■■ COD.	PAG.	■■■■ COD.	PAG.	■■■■ COD.	PAG.
5602-LBN-DA2	251	5620-LBN-DA4	257	57165C-LBC-24	203	57169C-LBC-15	203
5602-LBN-DIM2	251	5620-LBN-DIM4	257	57165C-LBC-40	203	57169C-LBC-24	203
5602-LBN-EM2	251	5621-LBC4	257	57165C-LBN-15	203	57169C-LBC-40	203
5605-LBC2	253	5621-LBC-DA4	257	57165C-LBN-24	203	57169C-LBN-15	203
5605-LBC-DA2	253	5621-LBC-DIM4	257	57165C-LBN-40	203	57169C-LBN-24	203
5605-LBC-DIM2	253	5621-LBN4	257	57165-LBC-10	199	57169C-LBN-40	203
5605-LBC-EM2	253	5621-LBN-DA4	257	57165-LBC-30	199	57169-LBC-10	199
5605-LBN2	253	5621-LBN-DIM4	257	57165-LBC-36	201	57169-LBC-30	199
5605-LBN-DA2	253	5622-LBC4	257	57165-LBC-45	199	57169-LBC-36	201
5605-LBN-DIM2	253	5622-LBC-DA4	257	57165-LBC-60	201	57169-LBC-45	199
5605-LBN-EM2	253	5622-LBC-DIM4	257	57165-LBI-10	199	57169-LBC-60	201
5606-LBC2	253	5622-LBN4	257	57165-LBI-30	199	57169-LBI-10	199
5606-LBC-DA2	253	5622-LBN-DA4	257	57165-LBI-45	199	57169-LBI-30	199
5606-LBC-DIM2	253	5622-LBN-DIM4	257	57165-LBN-36	201	57169-LBI-45	199
5606-LBC-EM2	253	5625-LBC	258	57165-LBN-60	201	57169-LBN-36	201
5606-LBN2	253	5625-LBC-DA	258	57165-RGBW-45	201	57169-LBN-60	201
5606-LBN-DA2	253	5625-LBN	258	57166C-LBC-15	203	57169-RGBW-45	201
5606-LBN-DIM2	253	5625-LBN-DA	258	57166C-LBC-24	203	57170C-LBC-15	203
5606-LBN-EM2	253	5626-LBC	258	57166C-LBC-40	203	57170C-LBC-24	203
5607-LBC2	253	5626-LBC-DA	258	57166C-LBN-15	203	57170C-LBC-40	203
5607-LBC-DA2	253	5626-LBN	258	57166C-LBN-24	203	57170C-LBN-15	203
5607-LBC-DIM2	253	5626-LBN-DA	258	57166C-LBN-40	203	57170C-LBN-24	203
5607-LBC-EM2	253	5627-LBC	258	57166-LBC-10	199	57170C-LBN-40	203
5607-LBN2	253	5627-LBC-DA	258	57166-LBC-30	199	57170-LBC-10	199
5607-LBN-DA2	253	5627-LBN	258	57166-LBC-36	201	57170-LBC-30	199
5607-LBN-DIM2	253	5627-LBN-DA	258	57166-LBC-45	199	57170-LBC-36	201
5607-LBN-EM2	253	5630-LBC	258	57166-LBC-60	201	57170-LBC-45	199
5610-LBC3	255	5630-LBC-DA	258	57166-LBI-10	199	57170-LBC-60	201
5610-LBC-DA3	255	5630-LBN	258	57166-LBI-30	199	57170-LBI-10	199
5610-LBC-DIM3	255	5630-LBN-DA	258	57166-LBI-45	199	57170-LBI-30	199
5610-LBN3	255	5631-LBC	258	57166-LBN-36	201	57170-LBI-45	199
5610-LBN-DA3	255	5631-LBC-DA	258	57166-LBN-60	201	57170-LBN-36	201
5610-LBN-DIM3	255	5631-LBN	258	57166-RGBW-45	201	57170-LBN-60	201
5611-LBC3	255	5631-LBN-DA	258	57167C-LBC-15	203	57170-RGBW-45	201
5611-LBC-DA3	255	5632-LBC	258	57167C-LBC-24	203	57171C-LBC-15	202
5611-LBC-DIM3	255	5632-LBC-DA	258	57167C-LBC-40	203	57171C-LBC-24	202
5611-LBN3	255	5632-LBN	258	57167C-LBN-15	203	57171C-LBC-40	202
5611-LBN-DA3	255	5632-LBN-DA	258	57167C-LBN-24	203	57171C-LBN-15	202
5611-LBN-DIM3	255	5635-LBC	259	57167C-LBN-40	203	57171C-LBN-24	202
5612-LBC3	255	5635-LBC-DA	259	57167-LBC-10	199	57171C-LBN-40	202
5612-LBC-DA3	255	5635-LBN	259	57167-LBC-30	199	57171-LBC-10	198
5612-LBC-DIM3	255	5635-LBN-DA	259	57167-LBC-36	201	57171-LBC-30	198
5612-LBN3	255	5636-LBC	259	57167-LBC-45	199	57171-LBC-36	200
5612-LBN-DA3	255	5636-LBC-DA	259	57167-LBC-60	201	57171-LBC-45	198
5612-LBN-DIM3	255	5636-LBN	259	57167-LBI-10	199	57171-LBC-60	200
5615-LBC4	257	5636-LBN-DA	259	57167-LBI-30	199	57171-LBI-10	198
5615-LBC-DA4	257	5637-LBC	259	57167-LBI-45	199	57171-LBI-30	198
5615-LBC-DIM4	257	5637-LBC-DA	259	57167-LBN-36	201	57171-LBI-45	198
5615-LBN4	257	5637-LBN	259	57167-LBN-60	201	57171-LBN-36	200
5615-LBN-DA4	257	5637-LBN-DA	259	57167-RGBW-45	201	57171-LBN-60	200
5615-LBN-DIM4	257	5640-LBC	259	57168C-LBC-15	203	57171-RGBW-45	200
5616-LBC4	257	5640-LBC-DA	259	57168C-LBC-24	203	57172C-LBC-15	202
5616-LBC-DA4	257	5640-LBN	259	57168C-LBC-40	203	57172C-LBC-24	202
5616-LBC-DIM4	257	5640-LBN-DA	259	57168C-LBN-15	203	57172C-LBC-40	202
5616-LBN4	257	5641-LBC	259	57168C-LBN-24	203	57172C-LBN-15	202
5616-LBN-DA4	257	5641-LBC-DA	259	57168C-LBN-40	203	57172C-LBN-24	202
5616-LBN-DIM4	257	5641-LBN	259	57168-LBC-10	199	57172C-LBN-40	202
5617-LBC4	257	5641-LBN-DA	259	57168-LBC-30	199	57172-LBC-10	198
5617-LBC-DA4	257	5642-LBC	259	57168-LBC-36	201	57172-LBC-30	198
5617-LBC-DIM4	257	5642-LBC-DA	259	57168-LBC-45	199	57172-LBC-36	200
5617-LBN4	257	5642-LBN	259	57168-LBC-60	201	57172-LBC-45	198
5617-LBN-DA4	257	5642-LBN-DA	259	57168-LBI-10	199	57172-LBC-60	200
5617-LBN-DIM4	257	5695-MLBC-25	95	57168-LBI-30	199	57172-LBI-10	198
5620-LBC4	257	5695-MLBC-40	95	57168-LBI-45	199	57172-LBI-30	198
5620-LBC-DA4	257	5695-MLBN-25	95	57168-LBN-36	201	57172-LBI-45	198
5620-LBC-DIM4	257	5695-MLBN-40	95	57168-LBN-60	201	57172-LBN-36	200
5620-LBN4	257	57165C-LBC-15	203	57168-RGBW-45	201	57172-LBN-60	200

COD.	PAG.	COD.	PAG.	COD.	PAG.	COD.	PAG.
57172-RGBW-45	200	57176-LBN-60	200	57552-LBI-60	53	57558-LBC-25	89
57173C-LBC-15	202	57176-RGBW-45	200	57552LBI60-DA	53	57558-LBC-40	89
57173C-LBC-24	202	57420-LBC	86	57552LBI-DA	53	57558-LBN-12	89
57173C-LBC-40	202	57420-LBN	86	57552R-LBC	59	57558-LBN-25	89
57173C-LBN-15	202	57420-LBC-DA	86	57552R-LBC-60	59	57558-LBN-40	89
57173C-LBN-24	202	57420-LBN-DA	86	57552RLBC60-DA	59	57558-MT	341
57173C-LBN-40	202	57421-LBC	86	57552RLBC-DA	59	57559-BC12-DA	89
57173-LBC-10	198	57421-LBN	86	57552R-LBI	59	57559-BC25-DA	89
57173-LBC-30	198	57421-LBC-DA	86	57552R-LBI-60	59	57559-BC40-DA	89
57173-LBC-36	200	57421-LBN-DA	86	57552RLBI60-DA	59	57559-BN12-DA	89
57173-LBC-45	198	57437-LBC	87	57552RLBI-DA	59	57559-BN25-DA	89
57173-LBC-60	200	57437-LBC-DA	87	57553AS-LBC	57	57559-BN40-DA	89
57173-LBI-10	198	57437-LBC-UGR	87	57553ASLBC-DA	57	57559-LBC-12	89
57173-LBI-30	198	57437-LBC-UGR-DA	87	57553AS-LBI	57	57559-LBC-25	89
57173-LBI-45	198	57437-LBN	87	57553ASLBI-DA	57	57559-LBC-40	89
57173-LBN-36	200	57437-LBN-DA	87	57553-LBC	53	57559-LBN-12	89
57173-LBN-60	200	57437-LBN-UGR	87	57553-LBC-60	53	57559-LBN-25	89
57173-RGBW-45	200	57437-LBN-UGR-DA	87	57553LBC60-DA	53	57559-LBN-40	89
57174C-LBC-15	202	57438-LBC	87	57553LBC-DA	53	57560-LBC	91
57174C-LBC-24	202	57438-LBC-DA	87	57553-LBI	53	57560-LBC-DA	91
57174C-LBC-40	202	57438-LBC-UGR	87	57553-LBI-60	53	57560-LBI	91
57174C-LBN-15	202	57438-LBC-UGR-DA	87	57553LBI60-DA	53	57560-LBI-DA	91
57174C-LBN-24	202	57438-LBN	87	57553LBI-DA	53	57561-LBC	91
57174C-LBN-40	202	57438-LBN-DA	87	57554-LBC-30	55	57561-LBC-DA	91
57174-LBC-10	198	57438-LBN-UGR	87	57554LBC30-DA	55	57561-LBI	91
57174-LBC-30	198	57438-LBN-UGR-DA	87	57554-LBC-60	55	57561-LBI-DA	91
57174-LBC-36	200	57550AS-LBC	57	57554LBC60-DA	55	57562-LBC	91
57174-LBC-45	198	57550ASLBC-DA	57	57554-LBI-30	55	57562-LBC-DA	91
57174-LBC-60	200	57550AS-LBI	57	57554LBI30-DA	55	57562-LBI	91
57174-LBI-10	198	57550ASLBI-DA	57	57554-LBI-60	55	57562-LBI-DA	91
57174-LBI-30	198	57550-LBC	53	57554LBI60-DA	55	57563-LBC	91
57174-LBI-45	198	57550-LBC-60	53	57555-LBC-30	55	57563-LBC-DA	91
57174-LBN-36	200	57550LBC60-DA	53	57555LBC30-DA	55	57563-LBI	91
57174-LBN-60	200	57550LBC-DA	53	57555-LBC-60	55	57563-LBI-DA	91
57174-RGBW-45	200	57550-LBI	53	57555LBC60-DA	55	57564-LBC	91
57175C-LBC-15	202	57550-LBI-60	53	57555-LBI-30	55	57564-LBC-DA	91
57175C-LBC-24	202	57550LBI60-DA	53	57555LBI30-DA	55	57564-LBI	91
57175C-LBC-40	202	57550LBI-DA	53	57555-LBI-60	55	57564-LBI-DA	91
57175C-LBN-15	202	57550R-LBC	59	57555LBI60-DA	55	57565-LBC	91
57175C-LBN-24	202	57550R-LBC-60	59	57556-LBC-30	55	57565-LBC-DA	91
57175C-LBN-40	202	57550RLBC60-DA	59	57556LBC30-DA	55	57565-LBI	91
57175-LBC-10	198	57550RLBC-DA	59	57556-LBC-60	55	57565-LBI-DA	91
57175-LBC-30	198	57550R-LBI	59	57556LBC60-DA	55	57566-FH	342
57175-LBC-36	200	57550R-LBI-60	59	57556-LBI-30	55	57566-FM	342
57175-LBC-45	198	57550RLBI60-DA	59	57556LBI30-DA	55	57566-FV	342
57175-LBC-60	200	57550RLBI-DA	59	57556-LBI-60	55	57566-GD	342
57175-LBI-10	198	57551AS-LBC	57	57556LBI60-DA	55	57566-GDP	342
57175-LBI-30	198	57551ASLBC-DA	57	57557-LBC-30	55	57566-LBC	91
57175-LBI-45	198	57551AS-LBI	57	57557LBC30-DA	55	57566-LBC-DA	91
57175-LBN-36	200	57551ASLBI-DA	57	57557-LBC-60	55	57566-LBI	91
57175-LBN-60	200	57551-LBC	53	57557LBC60-DA	55	57566-LBI-DA	91
57175-RGBW-45	200	57551-LBC-60	53	57557-LBI-30	55	57566-MT	342
57176C-LBC-15	202	57551LBC60-DA	53	57557LBI30-DA	55	57567-LBC	91
57176C-LBC-24	202	57551LBC-DA	53	57557-LBI-60	55	57567-LBC-DA	91
57176C-LBC-40	202	57551-LBI	53	57557LBI60-DA	55	57567-LBI	91
57176C-LBN-15	202	57551-LBI-60	53	57558-BC12-DA	89	57567-LBI-DA	91
57176C-LBN-24	202	57551LBI60-DA	53	57558-BC25-DA	89	57570-LBC	93
57176C-LBN-40	202	57551LBI-DA	53	57558-BC40-DA	89	57570-LBC-DA	93
57176-LBC-10	198	57552AS-LBC	57	57558-BN12-DA	89	57570-LBI	93
57176-LBC-30	198	57552ASLBC-DA	57	57558-BN25-DA	89	57570-LBI-DA	93
57176-LBC-36	200	57552AS-LBI	57	57558-BN40-DA	89	57571-LBC	93
57176-LBC-45	198	57552ASLBI-DA	57	57558-FH	341	57571-LBC-DA	93
57176-LBC-60	200	57552-LBC	53	57558-FM	341	57571-LBI	93
57176-LBI-10	198	57552-LBC-60	53	57558-FV	341	57571-LBI-DA	93
57176-LBI-30	198	57552LBC60-DA	53	57558-GD	341	57572-LBC	93
57176-LBI-45	198	57552LBC-DA	53	57558-GDP	341	57572-LBC-DA	93
57176-LBN-36	200	57552-LBI	53	57558-LBC-12	89	57572-LBI	93

INDICE CODICE PRODOTTI - PRODUCTS CODES INDEX

■■■■ COD.	PAG.	■■■■ COD.	PAG.	■■■■ COD.	PAG.	■■■■ COD.	PAG.
57572-LBI-DA	93	57585-GDP-60	345	6040-830	288	620-9090-LBN-OP	327
57573-LBC	93	57585-LBC-30	55	6040-840	288	630-100-LBC-OP	329
57573-LBC-DA	93	57585LBC30-DA	55	6041-827	288	630-100-LBN-OP	329
57573-LBI	93	57585-LBC-60	55	6041-830	288	630-200-LBC-OP	329
57573-LBI-DA	93	57585LBC60-DA	55	6041-840	288	630-200-LBN-OP	329
57575-FH	343	57585-LBI-30	55	6042-827	288	630-300-LBC-OP	329
57575-FM	343	57585LBI30-DA	55	6042-840	288	630-300-LBN-OP	329
57575-FV	343	57585-LBI-60	55	6042-840	288	63056-LBC-30	216
57575-GD	343	57585LBI60-DA	55	6043-827	288	63056-LBC-30S	217
57575-GDP	343	57585-MT-60	345	6043-830	288	63056-LBC-60	216
57575-LBC	93	57586-LBC-30	55	6043-840	288	63056-LBC-60S	217
57575-LBC-DA	93	57586LBC30-DA	55	6044-827	288	63056-LBI-30	216
57575-LBI	93	57586-LBC-60	55	6044-830	288	63056-LBI-30S	217
57575-LBI-DA	93	57586LBC60-DA	55	6044-840	288	63056-LBI-60	216
57575-MT	343	57586-LBI-30	55	6045-827	288	63056-LBI-60S	217
57576-LBC	93	57586LBI30-DA	55	6045-830	288	63057-LBC-30	216
57576-LBC-DA	93	57586-LBI-60	55	6045-840	288	63057-LBC-30S	217
57576-LBI	93	57586LBI60-DA	55	6046-827	288	63057-LBC-60	216
57576-LBI-DA	93	5798-LBC	95	6046-830	288	63057-LBC-60S	217
57580AS-LBC	57	5798-LBN	95	6046-840	288	63057-LBI-30	216
57580ASLBC-DA	57	588123	181	6047-827	288	63057-LBI-30S	217
57580AS-LBI	57	588223	181	6047-830	288	63057-LBI-60	216
57580ASLBI-DA	57	6011	327	6047-840	288	63057-LBI-60S	217
57580-FH-60	344	60110-LBC	113	6048-827	288	63058-LBC-30	216
57580-FM-60	344	60110-LBN	113	6048-830	288	63058-LBC-30S	217
57580-FV-60	344	60111-LBC	113	6048-840	288	63058-LBC-60	216
57580-GD-60	344	60111-LBN	113	6049-827	288	63058-LBC-60S	217
57580-GDP-60	344	6017	297	6049-830	288	63058-LBI-30	216
57580-LBC-30	53	6018	297	6049-840	288	63058-LBI-30S	217
57580LBC30-DA	53	6019	297	6050-827	289	63058-LBI-60	216
57580-LBC-60	53	6020	297	6050-830	289	63058-LBI-60S	217
57580LBC60-DA	53	6022	297	6050-840	289	63059-LBC-30	216
57580-LBI-30	53	6023	297	6051-827	289	63059-LBC-30S	217
57580LBI30-DA	53	6028	297	6051-830	289	63059-LBC-60	216
57580-LBI-60	53	6029	296	6051-840	289	63059-LBC-60S	217
57580LBI60-DA	53	6029-3	296	6052-827	289	63059-LBI-30	216
57580-MT-60	344	6030-827	288	6052-830	289	63059-LBI-30S	217
57580R-FH-60	347	6030-830	288	6052-840	289	63059-LBI-60	216
57580R-FM-60	347	6030-840	288	6053-827	289	63059-LBI-60S	217
57580R-FV-60	347	6031-827	288	6053-830	289	63065-LBC	268
57580R-GD-60	347	6031-830	288	6053-840	289	63065-LBC-S	269
57580R-GDP-60	347	6031-840	288	6054-827	289	63065-LBN	268
57580R-LBC-30	59	6032-827	288	6054-830	289	63065-LBN-S	269
57580RLBC3-DA	59	6032-830	288	6054-840	289	63066-LBC	268
57580R-LBC-60	59	6032-840	288	6055-827	289	63066-LBC-S	269
57580RLBC6-DA	59	6033-827	288	6055-830	289	63066-LBN	268
57580R-LBI-30	59	6033-830	288	6055-840	289	63066-LBN-S	269
57580RLBI3-DA	59	6033-840	288	6056-827	289	63067-LBC	268
57580R-LBI-60	59	6034-827	288	6056-830	289	63067-LBC-S	269
57580RLBI6-DA	59	6034-830	288	6056-840	289	63067-LBN	268
57580R-MT-60	347	6034-840	288	6057-827	289	63067-LBN-S	269
57581AS-LBC	57	6035-827	288	6057-830	289	63068-LBC	268
57581ASLBC-DA	57	6035-830	288	6057-840	289	63068-LBC-S	269
57581AS-LBI	57	6035-840	288	6058-827	289	63068-LBN	268
57581ASLBI-DA	57	6036-827	288	6058-830	289	63068-LBN-S	269
57581-LBC-30	53	6036-830	288	6058-840	289	63069-LBC	268
57581LBC30-DA	53	6036-840	288	6059-827	289	63069-LBC-S	269
57581-LBC-60	53	6037-827	288	6059-830	289	63069-LBN	268
57581LBC60-DA	53	6037-830	288	6059-840	289	63069-LBN-S	269
57581-LBI-30	53	6037-840	288	62000-10	217	63070-LBC	268
57581LBI30-DA	53	6038-827	288	620-100-LBC-OP	327	63070-LBC-S	269
57581-LBI-60	53	6038-830	288	620-100-LBN-OP	327	63070-LBN	268
57581LBI60-DA	53	6038-840	288	620-200-LBC-OP	327	63070-LBN-S	269
57585-FH-60	345	6039-827	288	620-200-LBN-OP	327	63075-LBC	270
57585-FM-60	345	6039-830	288	620-300-LBC-OP	327	63075-LBC-S	271
57585-FV-60	345	6039-840	288	620-300-LBN-OP	327	63075-LBN	270
57585-GD-60	345	6040-827	288	620-9090-LBC-OP	327	63075-LBN-S	271

COD.	PAG.	COD.	PAG.	COD.	PAG.	COD.	PAG.
63076-LBC	270	645176	658	645837-I	657	655-200-LBC-OP	335
63076-LBC-S	271	645177	658	645838-I	657	655-300-LBC-OP	335
63076-LBN	270	645178	658	645839	660	655-9090-LBC-OP	335
63076-LBN-S	271	645179	658	645839-I	660	655-9090-LBN-OP	335
63077-LBC	270	645216	658	645840	660	67191-LBC	147
63077-LBC-S	271	645229	669	645840-I	660	67191-LBC-40	147
63077-LBN	270	645230	383	645845	661	67191LBC40-DA	147
63077-LBN-S	271	645245	559	645906	656	67191-LBC-60	147
63078-LBC	270	645246	559	645906	658	67191LBC60-DA	147
63078-LBC-S	271	645247	559	645938	657	67191LBC-DA	147
63078-LBN	270	645247	666	645939	661	67191-LBN	147
63078-LBN-S	271	645256-LBC	290	645981	656	67191-LBN-40	147
630-9090-LBC-OP	329	645256-LBC-IP	292	645984	656	67191LBN40-DA	147
630-9090-LBN-OP	329	645256-LBI	290	646164-LBC	290	67191-LBN-60	147
631-100-LBC-OP	330	645256-LBI-IP	292	646164-LBN	290	67191LBN60-DA	147
631-100-LBN-OP	330	645256-LBL	290	646164-LBN-IP	292	67191LBN-DA	147
631-200-LBC-OP	330	645256-LBL-IP	292	646165-LBC	291	67192-LBC	147
631-200-LBN-OP	330	645256-LBN	290	646165-LBC	327	67192-LBC-40	147
631-300-LBC-OP	330	645256-LBN-IP	292	646165-LBC-IP	293	67192LBC40-DA	147
631-300-LBN-OP	330	645256-RGB	290	646165-LBI	291	67192-LBC-60	147
631-9090-LBC-OP	330	645256-RGB	292	646165-LBI-IP	293	67192LBC60-DA	147
631-9090-LBN-OP	330	645258-RGB	292	646165-LBN	291	67192LBC-DA	147
632-100-LBC-OP	331	645262	659	646165-LBN	327	67192-LBN	147
632-100-LBN-OP	331	645280	666	646165-LBN-IP	293	67192-LBN-40	147
632-200-LBC-OP	331	645384	657	646168-I	656	67192LBN40-DA	147
632-200-LBN-OP	331	645384-4	660	646195-LBC	293	67192-LBN-60	147
632-300-LBC-OP	331	645384-DA	660	646195-LBN	293	67192LBN60-DA	147
632-300-LBN-OP	331	645452-LBC	291	646209	658	67192LBN-DA	147
632-9090-LBC-OP	331	645452-LBC27	291	646258-67	656	67193-LBC	147
632-9090-LBN-OP	331	645452-LBC-IP	293	646308	643	67193-LBC-40	147
633-100-LBC-OP	333	645452-LBI-IP	293	646312	656	67193LBC40-DA	147
633-100-LBN-OP	333	645452-LBL	291	646338-930	126	67193-LBC-60	147
633-200-LBC-OP	333	645452-LBN	291	646338-940	126	67193LBC60-DA	147
633-200-LBN-OP	333	645452-LBN-IP	293	646339-930	126	67193LBC-DA	147
633-300-LBC-OP	333	645469	658	646339-940	126	67193-LBN	147
633-300-LBN-OP	333	645474	658	646340-930	126	67193-LBN-40	147
633-9090-LBC-OP	333	645475	658	646340-940	126	67193LBN40-DA	147
633-9090-LBN-OP	333	645489	658	646347-930	126	67193-LBN-60	147
64001	205	645490	658	646347-940	126	67193LBN60-DA	147
64002	205	645496	656	646348-930	126	67193LBN-DA	147
64007	205	645538	660	646348-940	126	67194-FH-20	356
64008	205	645544	658	646349-I	656	67194-FH-40	356
64015	205	645567	658	646364	656	67194-FH-60	356
64016	205	645586	658	646371	658	67194-FM-20	356
64025	205	645588	656	646372-1	662	67194-FM-40	356
64026	205	645606	658	646372-2	665	67194-FM-60	356
644522	181	645626-1	656	646372-3	664	67194-FV-20	356
644523	181	645646-BC	32	646375	593	67194-FV-40	356
644579	181	645646-BI	32	646399-930	668	67194-FV-60	356
644579	187	645646-BN	32	646399-940	668	67194-GD-20	356
644580	181	645647-BC	32	646401-830	668	67194-GD-40	356
644599	658	645647-BI	32	646401-840	668	67194-GD-60	356
644757	657	645647-BN	32	646401-930	668	67194-GDP-20	356
644757-DA	660	645658	660	646401-940	668	67194-GDP-40	356
644758	656	645673	656	646402-830	668	67194-GDP-60	356
644758-5	656	645683	660	646402-840	668	67194-LBC	147
644759-1	656	645683-1	660	646402-930	668	67194-LBC-40	147
644888	658	645686	660	646402-940	668	67194LBC40-DA	147
644889	658	645687	660	646433	657	67194-LBC-60	147
644936	656	645688	656	646434	657	67194LBC60-DA	147
644936-67	656	645688-DA	660	646435	657	67194LBC-DA	147
644940	656	645746	658	646636	412	67194-LBN	147
644940-67	656	645764	656	646688-930	668	67194-LBN-40	147
644973	657	645777-LBC	283	646688-940	668	67194LBN40-DA	147
644973-1	657	645777-LBI	283	646689-930	668	67194-LBN-60	147
645038	658	645777-LBN	283	646689-940	668	67194LBN60-DA	147
645086	656	645833	657	655-100-LBC-OP	335	67194LBN-DA	147

■■■■ COD.	PAG.	■■■■ COD.	PAG.	■■■■ COD.	PAG.	■■■■ COD.	PAG.
67194-MT-20	356	67305K-FV-25	355	67309-MT	353	67350K-MT-30	354
67194-MT-40	356	67305K-FV-60	355	67310-FH	353	67350K-MT-60	354
67194-MT-60	356	67305K-GD-25	355	67310-FM	353	67351K-FH-15	354
67195-FH-20	356	67305K-GD-60	355	67310-FV	353	67351K-FH-30	354
67195-FH-40	356	67305K-GDP-25	355	67310-GD	353	67351K-FH-60	354
67195-FH-60	356	67305K-GDP-60	355	67310-GDP	353	67351K-FM-15	354
67195-FM-20	356	67305K-LBC-25	139	67310-LBC-15	141	67351K-FM-30	354
67195-FM-40	356	67305K-LBC-60	139	67310-LBC-25	141	67351K-FM-60	354
67195-FM-60	356	67305K-LBN-25	139	67310-LBC-40	141	67351K-FV-15	354
67195-FV-20	356	67305K-LBN-60	139	67310-LBC-60	141	67351K-FV-30	354
67195-FV-40	356	67305K-MT-25	355	67310-LBC-60	141	67351K-FV-60	354
67195-FV-60	356	67305K-MT-60	355	67310-LBN-15	141	67351K-GD-15	354
67195-GD-20	356	67306K-FH-25	355	67310-LBN-40	141	67351K-GD-30	354
67195-GD-40	356	67306K-FH-60	355	67310-LBN-60	141	67351K-GD-60	354
67195-GD-60	356	67306K-FM-25	355	67310-MT	353	67351K-GDP-15	354
67195-GDP-20	356	67306K-FM-60	355	67325-LBC12AG	149	67351K-GDP-30	354
67195-GDP-40	356	67306K-FV-25	355	67325-LBC25AG	149	67351K-GDP-60	354
67195-GDP-60	356	67306K-FV-60	355	67325-LBC40AG	149	67351K-MT-15	354
67195-LBC	147	67306K-GD-25	355	67325-LBN12AG	149	67351K-MT-30	354
67195-LBC-40	147	67306K-GD-60	355	67325-LBN25AG	149	67351K-MT-60	354
67195LBC40-DA	147	67306K-GDP-25	355	67325-LBN40AG	149	67352K-FH-15	354
67195-LBC-60	147	67306K-GDP-60	355	67326-LBC12AG	149	67352K-FH-30	354
67195LBC60-DA	147	67306K-LBC-25	139	67326-LBC25AG	149	67352K-FH-60	354
67195LBC-DA	147	67306K-LBC-60	139	67326-LBC40AG	149	67352K-FM-15	354
67195-LBN	147	67306K-LBN-25	139	67326-LBN12AG	149	67352K-FM-30	354
67195-LBN-40	147	67306K-LBN-60	139	67326-LBN25AG	149	67352K-FM-60	354
67195LBN40-DA	147	67306K-MT-25	355	67326-LBN40AG	149	67352K-FV-15	354
67195-LBN-60	147	67306K-MT-60	355	67335-LBC-15	136	67352K-FV-30	354
67195LBN60-DA	147	67307K-FH-25	355	67335-LBC-25	136	67352K-FV-60	354
67195LBN-DA	147	67307K-FH-60	355	67335-LBC-40	136	67352K-GD-15	354
67195-MT-20	356	67307K-FM-25	355	67335-LBN-15	136	67352K-GD-30	354
67195-MT-40	356	67307K-FM-60	355	67335-LBN-25	136	67352K-GD-60	354
67195-MT-60	356	67307K-FV-25	355	67335-LBN-40	136	67352K-GDP-15	354
67196-FH-20	356	67307K-FV-60	355	67335P-LBC-15	136	67352K-GDP-30	354
67196-FH-40	356	67307K-GD-25	355	67335P-LBC-25	136	67352K-GDP-60	354
67196-FH-60	356	67307K-GD-60	355	67335P-LBC-40	136	67352K-MT-15	354
67196-FM-20	356	67307K-GDP-25	355	67335P-LBN-15	136	67352K-MT-30	354
67196-FM-40	356	67307K-GDP-60	355	67335P-LBN-25	136	67352K-MT-60	354
67196-FM-60	356	67307K-MT-25	355	67335P-LBN-40	136	67355-LBC-15	137
67196-FV-20	356	67307K-MT-60	355	67336-LBC-15	136	67355-LBC-30	137
67196-FV-40	356	67308-FH	353	67336-LBC-25	136	67355-LBC-60	137
67196-FV-60	356	67308-FM	353	67336-LBC-40	136	67355-LBN-15	137
67196-GD-20	356	67308-FV	353	67336-LBN-15	136	67355-LBN-30	137
67196-GD-40	356	67308-GD	353	67336-LBN-25	136	67355-LBN-60	137
67196-GD-60	356	67308-GDP	353	67336-LBN-40	136	67356-LBC-15	137
67196-GDP-20	356	67308-LBC-15	141	67336P-LBC-15	136	67356-LBC-30	137
67196-GDP-40	356	67308-LBC-25	141	67336P-LBC-25	136	67356-LBC-60	137
67196-GDP-60	356	67308-LBC-40	141	67336P-LBC-40	136	67356-LBN-15	137
67196-LBC	147	67308-LBC-60	141	67336P-LBN-15	136	67356-LBN-30	137
67196-LBC-40	147	67308-LBN-15	141	67336P-LBN-25	136	67356-LBN-60	137
67196LBC40-DA	147	67308-LBN-25	141	67336P-LBN-40	136	67357-LBC-15	137
67196-LBC-60	147	67308-LBN-40	141	67350K-FH-15	354	67357-LBC-30	137
67196LBC60-DA	147	67308-LBN-60	141	67350K-FH-30	354	67357-LBC-60	137
67196LBC-DA	147	67308-MT	353	67350K-FH-60	354	67357-LBN-15	137
67196-LBN	147	67309-FH	353	67350K-FM-15	354	67357-LBN-30	137
67196-LBN-40	147	67309-FM	353	67350K-FM-30	354	67357-LBN-60	137
67196LBN40-DA	147	67309-FV	353	67350K-FM-60	354	67360-LBC	189
67196-LBN-60	147	67309-GD	353	67350K-FV-15	354	67360-LBN	189
67196LBN60-DA	147	67309-GDP	353	67350K-FV-30	354	67361-LBC	189
67196LBN-DA	147	67309-LBC-15	141	67350K-FV-60	354	67361-LBN	189
67196-MT-20	356	67309-LBC-25	141	67350K-GD-15	354	67362-LBC	189
67196-MT-40	356	67309-LBC-40	141	67350K-GD-30	354	67362-LBN	189
67196-MT-60	356	67309-LBC-60	141	67350K-GD-60	354	67365-LBC	189
67305K-FH-25	355	67309-LBN-15	141	67350K-GDP-15	354	67365-LBN	189
67305K-FH-60	355	67309-LBN-25	141	67350K-GDP-30	354	67366-LBC	189
67305K-FM-25	355	67309-LBN-40	141	67350K-GDP-60	354	67366-LBN	189
67305K-FM-60	355	67309-LBN-60	141	67350K-MT-15	354	67367-LBC	189

COD.	PAG.	COD.	PAG.	COD.	PAG.	COD.	PAG.
67367-LBN	189	67395-LBC-20	135	67772-LBC-40	143	67778LBI60-DA	144
67370-LBC	189	67395-LBC-20M	61	67772LBC40-DA	143	67770LBC40-DA	143
67370-LBN	189	67395-LBC-40	135	67772-LBI-15	143	67780-LBC	161
67371-LBC	189	67395-LBC-40M	61	67772LBI15-DA	143	67780-LBC-60	161
67371-LBN	189	67395-LBN-20	135	67772-LBI-25	143	67780-LBN	161
67372-LBC	189	67395-LBN-20M	61	67772LBI25-DA	143	67780-LBN-60	161
67372-LBN	189	67395-LBN-40	135	67772-LBI-40	143	67781-LBC	161
67375-LBC	189	67395-LBN-40M	61	67772LBI40-DA	143	67781-LBC-60	161
67375-LBN	189	67396-LBC-20	135	67773-LBC-15	143	67781-LBN	161
67376-LBC	189	67396-LBC-20M	61	67773LBC15-DA	143	67781-LBN-60	161
67376-LBN	189	67396-LBC-40	135	67773-LBC-25	143	67782-LBC	161
67377-LBC	189	67396-LBC-40M	61	67773LBC25-DA	143	67782-LBC-60	161
67377-LBN	189	67396-LBN-20	135	67773-LBC-40	143	67782-LBN	161
67380-LBC	189	67396-LBN-20M	61	67773LBC40-DA	143	67782-LBN-60	161
67380-LBN	189	67396-LBN-40	135	67773-LBI-15	143	67783-LBC	219
67381-LBC	189	67396-LBN-40M	61	67773LBI15-DA	143	67783-LBC-60	219
67381-LBN	189	67397-LBC12AG	151	67773-LBI-25	143	67783-LBN	219
67382-LBC	189	67397-LBC25AG	151	67773LBI25-DA	143	67783-LBN-60	219
67382-LBN	189	67397-LBC40AG	151	67773-LBI-40	143	67784-LBC	219
67383-LBC-20	191	67397-LBN12AG	151	67773LBI40-DA	143	67784-LBC-60	219
67383-LBC-40	191	67397-LBN25AG	151	67774-LBC-15	143	67784-LBN	219
67383-LBN-20	191	67397-LBN40AG	151	67774LBC15-DA	143	67784-LBN-60	219
67383-LBN-40	191	67398-LBC12AG	151	67774-LBC-25	143	67785-LBC	219
67384-LBC-20	191	67398-LBC25AG	151	67774LBC25-DA	143	67785-LBC-60	219
67384-LBC-40	191	67398-LBC40AG	151	67774-LBC-40	143	67785-LBN	219
67384-LBN-20	191	67398-LBN12AG	151	67774LBC40-DA	143	67785-LBN-60	219
67384-LBN-40	191	67398-LBN25AG	151	67774-LBI-15	143	67790-LBC	161
67385-LBC-20	191	67398-LBN40AG	151	67774LBI15-DA	143	67790-LBC-60	161
67385-LBC-40	191	67405-LBC	153	67774-LBI-25	143	67790-LBN	161
67385-LBN-20	191	67405-LBN	153	67774LBI25-DA	143	67790-LBN-60	161
67385-LBN-40	191	67406-LBC	153	67774-LBI-40	143	67791-LBC	161
67386-LBC-20	191	67406-LBN	153	67774LBI40-DA	143	67791-LBC-60	161
67386-LBC-40	191	675-100-LBC-OP	337	67775-LBC-15	143	67791-LBN	161
67386-LBN-20	191	675-100-LBN-OP	337	67775LBC15-DA	143	67791-LBN-60	161
67386-LBN-40	191	675-200-LBC-OP	337	67775-LBC-25	143	67792-LBC	161
67387-LBC-20	191	675-200-LBN-OP	337	67775LBC25-DA	143	67792-LBC-60	161
67387-LBC-40	191	675-300-LBC-OP	337	67775-LBC-40	143	67792-LBN	161
67387-LBN-20	191	675-300-LBN-OP	337	67775LBC40-DA	143	67792-LBN-60	161
67387-LBN-40	191	675-9090-LBC-OP	337	67775-LBI-15	143	67793-LBC	219
67388-LBC-20	191	675-9090-LBN-OP	337	67775LBI15-DA	143	67793-LBC-60	219
67388-LBC-40	191	67770-LBC-15	143	67775-LBI-25	143	67793-LBN	219
67388-LBN-20	191	67770LBC15-DA	143	67775LBI25-DA	143	67793-LBN-60	219
67388-LBN-40	191	67770-LBC-25	143	67775-LBI-40	143	67794-LBC	219
67389-LBC-20	191	67770LBC25-DA	143	67775LBI40-DA	143	67794-LBC-60	219
67389-LBC-40	191	67770-LBC-40	143	67776-LBC-30	144	67794-LBN	219
67389-LBN-20	191	67770-LBI-15	143	67776LBC30-DA	144	67794-LBN-60	219
67389-LBN-40	191	67770LBI15-DA	143	67776-LBC-60	144	67795-LBC	219
67390-LBC-20	191	67770-LBI-25	143	67776LBC60-DA	144	67795-LBC-60	219
67390-LBC-40	191	67770LBI25-DA	143	67776-LBI-30	144	67795-LBN	219
67390-LBN-20	191	67770-LBI-40	143	67776LBI30-DA	144	67795-LBN-60	219
67390-LBN-40	191	67770LBI40-DA	143	67776-LBI-60	144	67800-LBC-30	145
67391-LBC-20	191	67771-LBC-15	143	67776LBI60-DA	144	67800LBC30-DA	145
67391-LBC-40	191	67771LBC15-DA	143	67777-LBC-30	144	67800-LBC-60	145
67391-LBN-20	191	67771-LBC-25	143	67777LBC30-DA	144	67800LBC60-DA	145
67391-LBN-40	191	67771LBC25-DA	143	67777-LBC-60	144	67800-LBI-30	145
67392-LBC-20	191	67771-LBC-40	143	67777LBC60-DA	144	67800LBI30-DA	145
67392-LBC-40	191	67771LBC40-DA	143	67777-LBI-30	144	67800-LBI-60	145
67392-LBN-20	191	67771-LBI-15	143	67777LBI30-DA	144	67800LBI60-DA	145
67392-LBN-40	191	67771LBI15-DA	143	67777-LBI-60	144	67801-LBC-30	145
67393-LBC-20	191	67771-LBI-25	143	67777LBI60-DA	144	67801LBC30-DA	145
67393-LBC-40	191	67771LBI25-DA	143	67778-LBC-30	144	67801-LBC-60	145
67393-LBN-20	191	67771-LBI-40	143	67778LBC30-DA	144	67801-LBC-30	145
67393-LBN-40	191	67771LBI40-DA	143	67778-LBC-60	144	67801LBI30-DA	145
67394-LBC-20	191	67772-LBC-15	143	67778LBC60-DA	144	67801-LBI-60	145
67394-LBC-40	191	67772LBC15-DA	143	67778-LBI-30	144	67801LBI60-DA	145
67394-LBN-20	191	67772-LBC-25	143	67778LBI30-DA	144	67802-LBC-30	145
67394-LBN-40	191	67772LBC25-DA	143	67778-LBI-60	144		

■■■■ COD.	PAG.	■■■■ COD.	PAG.	■■■■ COD.	PAG.	■■■■ COD.	PAG.
67802LBC30-DA	145	67815-LBC-30	75	67835LBN24-DA	157	67842-LBC-19	158
67802-LBC-60	145	67815-LBC-30-DA	75	67835-LBN-36	157	67842LBC19-DA	158
67802LBC60-DA	145	67815-LBC-8	75	67835LBN36-DA	157	67842-LBC-27	158
67802-LBI-30	145	67815-LBC-8-DA	75	67836-LBC-15	157	67842LBC27-DA	158
67802LBI30-DA	145	67815-LBN-30	75	67836LBC15-DA	157	67842-LBC-38	158
67802-LBI-60	145	67815-LBN-30-DA	75	67836-LBC-24	157	67842LBC38-DA	158
67802LBI60-DA	145	67815-LBN-8	75	67836LBC24-DA	157	67842-LBC-56	158
67805-FH-60	357	67815-LBN-8-DA	75	67836-LBC-36	157	67842LBC56-DA	158
67805-FM-60	357	67816-LBC-30	75	67836LBC36-DA	157	67842-LBC-6	158
67805-FV-60	357	67816-LBC-30-DA	75	67836-LBN-15	157	67842LBC6-DA	158
67805-GD-60	357	67816-LBC-8	75	67836LBN15-DA	157	67842-LBN-19	158
67805-GDP-60	357	67816-LBC-8-DA	75	67836-LBN-24	157	67842LBN19-DA	158
67805-LBC-30	144	67816-LBN-30	75	67836LBN24-DA	157	67842-LBN-27	158
67805LBC30-DA	144	67816-LBN-30-DA	75	67836-LBN-36	157	67842LBN27-DA	158
67805-LBC-60	144	67816-LBN-8	75	67836LBN36-DA	157	67842-LBN-38	158
67805LBC60-DA	144	67816-LBN-8-DA	75	67837-LBC-15	157	67842LBN38-DA	158
67805-LBI-30	144	67825-LBC-30	155	67837LBC15-DA	157	67842-LBN-56	158
67805LBI30-DA	144	67825LBC30-DA	155	67837-LBC-24	157	67842LBN56-DA	158
67805-LBI-60	144	67825-LBC-8	155	67837LBC24-DA	157	67842-LBN-6	158
67805LBI60-DA	144	67825LBC8-DA	155	67837-LBC-36	157	67842LBN6-DA	158
67805-MT-60	357	67825-LBN-30	155	67837LBC36-DA	157	67845-LBC-19	159
67806-LBC-30	144	67825LBN30-DA	155	67837-LBN-15	157	67845LBC19-DA	159
67806LBC30-DA	144	67825-LBN-8	155	67837LBN15-DA	157	67845-LBC-27	159
67806-LBC-60	144	67825LBN8-DA	155	67837-LBN-24	157	67845LBC27-DA	159
67806LBC60-DA	144	67826-LBC-30	155	67837LBN24-DA	157	67845-LBC-38	159
67806-LBI-30	144	67826LBC30-DA	155	67837-LBN-36	157	67845LBC38-DA	159
67806LBI30-DA	144	67826-LBC-8	155	67837LBN36-DA	157	67845-LBC-56	159
67806-LBI-60	144	67826LBC8-DA	155	67840-LBC-19	158	67845LBC56-DA	159
67806LBI60-DA	144	67826-LBN-30	155	67840LBC19-DA	158	67845-LBC-6	159
67807-LBC-30	144	67826LBN30-DA	155	67840-LBC-27	158	67845LBC6-DA	159
67807LBC30-DA	144	67826-LBN-8	155	67840LBC27-DA	158	67845-LBN-19	159
67807-LBC-60	144	67826LBN8-DA	155	67840-LBC-38	158	67845LBN19-DA	159
67807LBC60-DA	144	67827-LBC-30	155	67840LBC38-DA	158	67845-LBN-27	159
67807-LBI-30	144	67827LBC30-DA	155	67840-LBC-56	158	67845LBN27-DA	159
67807LBI30-DA	144	67827-LBC-8	155	67840LBC56-DA	158	67845-LBN-38	159
67807-LBI-60	144	67827LBC8-DA	155	67840-LBC-6	158	67845LBN38-DA	159
67807LBI60-DA	144	67827-LBN-30	155	67840LBC6-DA	158	67845-LBN-56	159
67808-FH-60	357	67827LBN30-DA	155	67840LBC6-DA	158	67845LBN56-DA	159
67808-FM-60	357	67827-LBN-8	155	67840-LBN-19	158	67845-LBN-6	159
67808-FV-60	357	67827LBN8-DA	155	67840LBN19-DA	158	67845LBN6-DA	159
67808-GD-60	357	67830-LBC-15	157	67840-LBN-27	158	67846-LBC-19	159
67808-GDP-60	357	67830-LBC-24	157	67840LBN27-DA	158	67846LBC19-DA	159
67808-LBC-30	145	67830-LBC-36	157	67840-LBN-38	158	67846-LBC-27	159
67808LBC30-DA	145	67830-LBN-15	157	67840LBN38-DA	158	67846-LBC-38	159
67808-LBC-60	145	67830-LBN-24	157	67840LBN56-DA	158	67846LBC38-DA	159
67808LBC60-DA	145	67830-LBN-36	157	67840-LBN-6	158	67846-LBC-56	159
67808-LBI-30	145	67831-LBC-15	157	67840LBN6-DA	158	67846LBC56-DA	159
67808LBI30-DA	145	67831-LBC-24	157	67841-LBC-19	158	67846-LBC-6	159
67808-LBI-60	145	67831-LBC-36	157	67841LBC19-DA	158	67846LBC6-DA	159
67808LBI60-DA	145	67831-LBN-15	157	67841-LBC-27	158	67846-LBN-19	159
67808-MT-60	357	67831-LBN-24	157	67841LBC27-DA	158	67846-LBN-27	159
67809-LBC-30	145	67831-LBN-36	157	67841-LBC-38	158	67846LBN19-DA	159
67809LBC30-DA	145	67832-LBC-15	157	67841LBC38-DA	158	67846-LBN-38	159
67809-LBC-60	145	67832-LBC-24	157	67841-LBC-56	158	67846LBN27-DA	159
67809LBC60-DA	145	67832-LBC-36	157	67841LBC56-DA	158	67846-LBN-38	159
67809-LBI-30	145	67832-LBN-15	157	67841-LBC-6	158	67846LBN38-DA	159
67809LBI30-DA	145	67832-LBN-24	157	67841LBC6-DA	158	67846-LBN-56	159
67809-LBI-60	145	67832-LBN-36	157	67841LBN-19	158	67846LBN56-DA	159
67809LBI60-DA	145	67835-LBC-15	157	67841LBN19-DA	158	67846-LBN-6	159
67810-LBC-30	145	67835LBC15-DA	157	67841-LBN-27	158	67846LBN6-DA	159
67810LBC30-DA	145	67835-LBC-24	157	67841LBN27-DA	158	67847-LBC-19	159
67810-LBC-60	145	67835LBC24-DA	157	67841-LBN-38	158	67847LBC19-DA	159
67810LBC60-DA	145	67835-LBC-36	157	67841LBN38-DA	158	67847-LBC-27	159
67810-LBI-30	145	67835LBC36-DA	157	67841-LBN-56	158	67847LBC27-DA	159
67810LBI30-DA	145	67835-LBN-15	157	67841LBN56-DA	158	67847-LBC-38	159
67810-LBI-60	145	67835LBN15-DA	157	67841-LBN-6	158	67847LBC38-DA	159
67810LBI60-DA	145	67835-LBN-24	157	67841LBN6-DA	158	67847-LBC-56	159

COD.	PAG.	COD.	PAG.	COD.	PAG.	COD.	PAG.
67847LBC56-DA	159	67885-LBC-6	158	67928-LBC	37	67967-LBN	221
67847-LBC-6	159	67885-LBN-19	158	67928-LBN	37	67967-LBN-F	223
67847LBC6-DA	159	67885-LBN-27	158	67929-LBC	37	67968-LBC	221
67847-LBN-19	159	67885-LBN-38	158	67929-LBN	37	67968-LBC-F	223
67847LBN19-DA	159	67885-LBN-56	158	67930-LBC	37	67968-LBN	221
67847-LBN-27	159	67885-LBN-6	158	67930-LBN	37	67968-LBN-F	223
67847LBN27-DA	159	67915C-LBC-15	73	67931-LBC	37	67969-LBC	164
67847-LBN-38	159	67915C-LBC-24	73	67931-LBN	37	67969-LBN	164
67847LBN38-DA	159	67915C-LBC-40	73	67932-LBC	39	67970-LBC	164
67847-LBN-56	159	67915C-LBN-15	73	67932-LBN	39	67970-LBN	164
67847LBN56-DA	159	67915C-LBN-24	73	67933-LBC	39	67971-LBC	164
67847-LBN-6	159	67915C-LBN-40	73	67933-LBN	39	67971-LBN	164
67847LBN6-DA	159	67915-LBC-10	73	67950-LBC	225	68035-LBC-25	63
67880-LBC-19	159	67915-LBC-30	73	67950-LBC-DA	225	68035LBC25-DA	63
67880-LBC-27	159	67915-LBC-45	73	67950-LBC-DA-F	227	68035-LBC-40	63
67880-LBC-38	159	67915-LBI-10	73	67950-LBC-F	227	68035LBC40-DA	63
67880-LBC-56	159	67915-LBI-30	73	67950-LBN	225	68035-LBN-25	63
67880-LBC-6	159	67915-LBI-45	73	67950-LBN-DA	225	68035LBN25-DA	63
67880-LBN-19	159	67915-LBI-10	73	67950-LBN-DA-F	227	68035-LBN-40	63
67880-LBN-27	159	67915-LBI-30	73	67950-LBN-F	227	68035LBN40-DA	63
67880-LBN-38	159	67915-LBI-45	73	67951-LBC	225	68036-LBC-25	63
67880-LBN-56	159	67916C-LBC-15	73	67951-LBC-DA	225	68036LBC25-DA	63
67880-LBN-6	159	67916C-LBC-24	73	67951-LBC-DA-F	227	68036-LBC-40	63
67881-LBC-19	159	67916C-LBC-40	73	67951-LBC-F	227	68036LBC40-DA	63
67881-LBC-27	159	67916C-LBN-15	73	67951-LBN	225	68036-LBN-25	63
67881-LBC-38	159	67916C-LBN-24	73	67951-LBN-DA	225	68036LBN25-DA	63
67881-LBC-56	159	67916C-LBN-40	73	67951-LBN-DA-F	227	68036-LBN-40	63
67881-LBC-6	159	67916-LBC-10	73	67951-LBN-F	227	68036LBN40-DA	63
67881-LBN-19	159	67916-LBC-30	73	67952-LBC	225	68037-LBC-25	63
67881-LBN-27	159	67916-LBC-45	73	67952-LBC-DA	225	68037LBC25-DA	63
67881-LBN-38	159	67916-LBI-10	73	67952-LBC-DA-F	227	68037-LBC-40	63
67881-LBN-56	159	67916-LBI-30	73	67952-LBC-F	227	68037LBC40-DA	63
67881-LBN-6	159	67916-LBI-45	73	67952-LBN	225	68037-LBN-25	63
67882-LBC-19	159	67916-LBI-10	73	67952-LBN-DA	225	68037LBN25-DA	63
67882-LBC-27	159	67916-LBI-30	73	67952-LBN-DA-F	227	68037-LBN-40	63
67882-LBC-38	159	67916-LBI-45	73	67952-LBN-F	227	68037LBN40-DA	63
67882-LBC-56	159	67917C-LBC-15	73	67953-LBC	165	68038-LBC-25	65
67882-LBC-6	159	67917C-LBC-24	73	67953-LBC	225	68038LBC25-DA	65
67882-LBN-19	159	67917C-LBC-40	73	67953-LBC-DA	165	68038-LBC-40	65
67882-LBN-27	159	67917C-LBN-15	73	67953-LBN	165	68038LBC40-DA	65
67882-LBN-38	159	67917C-LBN-24	73	67953-LBN-DA	165	68038-LBN-25	65
67882-LBN-56	159	67917C-LBN-40	73	67954-LBC	165	68038LBN25-DA	65
67882-LBN-6	159	67917-LBC-10	73	67954-LBC-DA	165	68038-LBN-40	65
67883-LBC-19	158	67917-LBC-30	73	67954-LBN	165	68038LBN40-DA	65
67883-LBC-27	158	67917-LBC-45	73	67954-LBN-DA	165	68039-LBC-25	65
67883-LBC-38	158	67917-LBI-10	73	67955-LBC	165	68039LBC25-DA	65
67883-LBC-56	158	67917-LBI-30	73	67955-LBC-DA	165	68039-LBC-40	65
67883-LBC-6	158	67917-LBI-45	73	67955-LBN	165	68039LBC40-DA	65
67883-LBN-19	158	67917-LBI-10	73	67955-LBN-DA	225	68039-LBN-25	65
67883-LBN-27	158	67917-LBI-30	73	67960-LBC	221	68039LBN25-DA	65
67883-LBN-38	158	67917-LBI-45	73	67960-LBN	221	68039-LBN-40	65
67883-LBN-56	158	67920-LBC	36	67961-LBC	221	68039LBN40-DA	65
67883-LBN-6	158	67920-LBN	36	67961-LBN	221	68040-LBC-25	65
67884-LBC-19	158	67921-LBC	36	67962-LBC	221	68040LBC25-DA	65
67884-LBC-27	158	67921-LBN	36	67962-LBN	221	68040-LBC-40	65
67884-LBC-38	158	67922-LBC	36	67963-LBC	164	68040LBC40-DA	65
67884-LBC-56	158	67922-LBN	36	67963-LBN	164	68040-LBN-25	65
67884-LBC-6	158	67923-LBC	36	67964-LBC	164	68040LBN25-DA	65
67884-LBN-19	158	67923-LBN	36	67964-LBN	164	68040-LBN-40	65
67884-LBN-27	158	67924-LBC	36	67965-LBC	164	68040LBN40-DA	65
67884-LBN-38	158	67924-LBN	36	67965-LBN	164	68041-LBC-25	67
67884-LBN-56	158	67925-LBC	36	67966-LBC	221	68041LBC25-DA	67
67884-LBN-6	158	67925-LBN	36	67966-LBC-F	223	68041-LBC-40	67
67885-LBC-19	158	67926-LBC	37	67966-LBN	221	68041LBC40-DA	67
67885-LBC-27	158	67926-LBN	37	67966-LBN-F	223	68041-LBN-25	67
67885-LBC-38	158	67927-LBC	37	67967-LBC	221	68041LBN25-DA	67
67885-LBC-56	158	67927-LBN	37	67967-LBN	223	68041-LBN-40	67

INDICE CODICE PRODOTTI · PRODUCTS CODES INDEX

COD.	PAG.	COD.	PAG.	COD.	PAG.	COD.	PAG.
68041LBN40-DA	67	699907	313	70510-MT-60	351	71105C-LBN-24	119
68042-LBC-25	67	699938-LBC	561	70511-LBC-30	130	71105C-LBN-40	119
68042LBC25-DA	67	699938-LBN	561	70511LBC30-DA	131	71106C-LBC-15	119
68042-LBC-40	67	699942-LBC	561	70511-LBC-60	130	71106C-LBC-24	119
68042LBC40-DA	67	699942-LBN	561	70511LBC60-DA	131	71106C-LBC-40	119
68042-LBN-25	67	70100	127	70511-LBI-30	130	71106C-LBN-15	119
68042LBN25-DA	67	70100-SC	129	70511LBI30-DA	131	71106C-LBN-24	119
68042-LBN-40	67	70101	127	70511-LBI-60	130	71106C-LBN-40	119
68042LBN40-DA	67	70101-SC	129	70511LBI60-DA	131	71106-MLBC-25	121
68043-LBC-25	67	7011	181	70600-LBC-30	130	71106-MLBC-40	121
68043LBC25-DA	67	70200	127	70600LBC30-DA	131	71106-MLBN-25	121
68043-LBC-40	67	70200-SC	129	70600-LBC-60	130	71106-MLBN-40	121
68043LBC40-DA	67	70201	127	70600LBC60-DA	131	71111-MLBC-25	121
68043-LBN-25	67	70201-SC	129	70600-LBI-30	130	71111-MLBC-40	121
68043LBN25-DA	67	70300	127	70600LBI30-DA	131	71111-MLBN-25	121
68043-LBN-40	67	70300-SC	129	70600-LBI-60	130	71111-MLBN-40	121
68043LBN40-DA	67	70301	127	70600LBI60-DA	131	71115C-LBC-15	124
68044-LBC-19	76	70301-SC	129	70601-LBC-30	130	71115C-LBC-24	124
68044-LBC-27	76	70410	127	70601LBC30-DA	131	71115C-LBC-40	124
68044-LBC-38	76	70410-SC	129	70601-LBC-60	130	71115C-LBN-15	124
68044-LBC-56	76	70411	127	70601LBC60-DA	131	71115C-LBN-24	124
68044-LBN-19	76	70411-SC	129	70601-LBI-30	130	71115C-LBN-40	124
68044-LBN-27	76	70500-LBC-30	130	70601LBI30-DA	131	71115-LBC-10	125
68044-LBN-38	76	70500LBC30-DA	131	70601-LBI-60	130	71115-LBI-10	125
68044-LBN-56	76	70500-LBC-60	130	70601LBI60-DA	131	71115-LBI-10	125
68045-LBC-19	76	70500LBC60-DA	131	70605-LBC-30	130	71115-RGB-10	125
68045-LBC-27	76	70500-LBI-30	130	70605LBC30-DA	131	71116C-LBC-15	124
68045-LBC-38	76	70500LBI30-DA	131	70605-LBC-60	130	71116C-LBC-15	124
68045-LBC-56	76	70500-LBI-60	130	70605LBC60-DA	131	71116C-LBC-24	124
68045-LBN-19	76	70500LBI60-DA	131	70605-LBI-30	130	71116C-LBC-40	124
68045-LBN-27	76	70501-LBC-30	130	70605LBI30-DA	131	71116C-LBN-15	124
68045-LBN-38	76	70501LBC30-DA	131	70605-LBI-60	130	71116C-LBN-24	124
68045-LBN-56	76	70501-LBC-60	130	70605LBI60-DA	131	71116C-LBN-40	124
68046-LBC-19	76	70501LBC60-DA	131	70606-LBC-30	130	71116-LBC-10	125
68046-LBC-27	76	70501-LBI-30	130	70606LBC30-DA	131	71116-LBI-10	125
68046-LBC-38	76	70501LBI30-DA	131	70606-LBC-60	130	71116-LBI-10	125
68046-LBC-56	76	70501-LBI-60	130	70606LBC60-DA	131	71116-RGB-10	125
68046-LBN-19	76	70501LBI60-DA	131	70606-LBI-30	130	71120C-LBC-15	124
68046-LBN-27	76	70505-LBC-30	130	70606LBI30-DA	131	71120C-LBC-24	124
68046-LBN-38	76	70505LBC30-DA	131	70606-LBI-60	130	71120C-LBC-40	124
68046-LBN-56	76	70505-LBC-60	130	70606LBI60-DA	131	71120C-LBN-15	124
68055-LBC-19	77	70505LBC60-DA	131	70615-FH-60	351	71120C-LBN-24	124
68055-LBC-27	77	70505-LBI-30	130	70615-FM-60	351	71120C-LBN-40	124
68055-LBC-38	77	70505LBI30-DA	131	70615-FV-60	351	71120-LBC-10	125
68055-LBC-56	77	70505-LBI-60	130	70615-GD-60	351	71120-LBI-10	125
68055-LBN-19	77	70505LBI60-DA	131	70615-GDP-60	351	71120-LBI-10	125
68055-LBN-27	77	70506-LBC-30	130	70615-LBC-30	130	71120-RGB-10	125
68055-LBN-38	77	70506LBC30-DA	131	70615LBC30-DA	131	71121C-LBC-24	124
68055-LBN-56	77	70506-LBC-60	130	70615-LBC-60	130	71121C-LBC-40	124
68056-LBC-19	77	70506LBC60-DA	131	70615LBC60-DA	131	71121C-LBN-15	124
68056-LBC-27	77	70506-LBI-30	130	70615-LBI-30	130	71121C-LBN-24	124
68056-LBC-38	77	70506LBI30-DA	131	70615LBI30-DA	131	71121C-LBN-40	124
68056-LBC-56	77	70506-LBI-60	130	70615-LBI-60	130	71121-LBC-10	125
68056-LBN-19	77	70506LBI60-DA	131	70615LBI60-DA	131	71121-LBI-10	125
68056-LBN-27	77	70510-FH-60	351	70615-MT-60	351	71121-LBI-10	125
68056-LBN-38	77	70510-FM-60	351	70616-LBC-30	130	71121-RGB-10	125
68056-LBN-56	77	70510-FV-60	351	70616LBC30-DA	131	71130C-LBC-15	122
68057-LBC-19	77	70510-GD-60	351	70616-LBC-60	130	71130C-LBC-24	122
68057-LBC-27	77	70510-GDP-60	351	70616LBC60-DA	131	71130C-LBC-40	122
68057-LBC-38	77	70510-LBC-30	130	70616-LBI-30	130	71130C-LBN-15	122
68057-LBC-56	77	70510LBC30-DA	131	70616LBI30-DA	131	71130C-LBN-24	122
68057-LBN-19	77	70510-LBC-60	130	70616-LBI-60	130	71130C-LBN-40	122
68057-LBN-27	77	70510LBC60-DA	131	70616LBI60-DA	131	71130-LBC-10	123
68057-LBN-38	77	70510-LBI-30	130	71105C-LBC-15	119	71130-LBI-10	123
68057-LBN-56	77	70510LBI30-DA	131	71105C-LBC-24	119	71130-LBI-10	123
699815	337	70510-LBI-60	130	71105C-LBC-40	119	71130-RGB-10	123
699816	337	70510LBI60-DA	131	71105C-LBN-15	119	71131C-LBC-15	122

COD.	PAG.	COD.	PAG.	COD.	PAG.	COD.	PAG.
71131C-LBC-24	122	980085	327	990925	158	D2216-MLBN-40	206
71131C-LBC-40	122	980086	327	990926	158	D2216-MLBN40S	211
71131C-LBN-15	122	980087	327	990930	158	D2217-MLBC-25	206
71131C-LBN-24	122	980088	327	990931	158	D2217-MLBC25S	211
71131C-LBN-40	122	980089	329	990991	181	D2217-MLBC-40	206
71131-LBC-10	123	980090	329	990992	181	D2217-MLBC40S	211
71131-LBI-10	123	980091	330	992590	183	D2217-MLBN-25	206
71131-LBL-10	123	980093	330	993241	183	D2217-MLBN25S	211
71131-RGB-10	123	980095	333	993242	183	D2217-MLBN-40	206
71135C-LBC-15	122	980096	333	993251	183	D2217-MLBN40S	211
71135C-LBC-24	122	980097	331	993252	183	D2218-MLBC-25	206
71135C-LBC-40	122	980099	331	993261	183	D2218-MLBC25S	211
71135C-LBN-15	122	980101	329	993262	183	D2218-MLBC-40	206
71135C-LBN-24	122	980102	329	993271	183	D2218-MLBC40S	211
71135C-LBN-40	122	980103	329	993272	183	D2218-MLBN-25	206
71135-LBC-10	123	980104	329	993281	183	D2218-MLBN25S	211
71135-LBI-10	123	980105	329	993282	183	D2218-MLBN-40	206
71135-LBL-10	123	980106	329	993283	183	D2218-MLBN40S	211
71135-RGB-10	123	980107	335	993284	183	D2225-MLBC-25	207
71136C-LBC-15	122	980108	335	993291	183	D2225-MLBC25S	213
71136C-LBC-24	122	980109	335	993292	183	D2225-MLBC-40	207
71136C-LBC-40	122	980110	335	993321	183	D2225-MLBC40S	213
71136C-LBN-15	122	980111	335	993331	183	D2225-MLBN-25	207
71136C-LBN-24	122	980112	335	993332	183	D2225-MLBN25S	213
71136C-LBN-40	122	980113	335	993333	183	D2225-MLBN-40	207
71136-LBC-10	123	980114	335	993334	183	D2225-MLBN40S	213
71136-LBI-10	123	980115	337	993381	183	D2226-MLBC-25	207
71136-LBL-10	123	980116	337	993382	183	D2226-MLBC25S	213
71136-RGB-10	123	980117	327	996980	184	D2226-MLBC-40	207
874	647	990241	180	999051	181	D2226-MLBC40S	213
880	639	990242	180	999052	181	D2226-MLBN-25	207
884-BR	493	990251	180	999061	181	D2226-MLBN25S	213
884-GR	493	990252	180	999062	181	D2226-MLBN-40	207
884-NE	493	990271	180	D2040	641	D2226-MLBN40S	213
888	639	990272	180	D2040-P	641	D2227-MLBC-25	207
889	639	990289	180	D2041	641	D2227-MLBC25S	213
894	643	990290	180	D2041-P	641	D2227-MLBC-40	207
895	649	990291	180	D2210-LBC	206	D2227-MLBC40S	213
898	637	990292	180	D2210-LBC-S	211	D2227-MLBN-25	207
899	645	990293	180	D2210-LBN	206	D2227-MLBN25S	213
980012-S-43	313	990294	180	D2210-LBN-S	211	D2227-MLBN-40	207
980012-S-64	317	990301	180	D2211-LBC	206	D2227-MLBN40S	213
980012-S-82	323	990302	180	D2211-LBC-S	211	D2234-LBC-15	206
98001306-T-43	313	990311	180	D2211-LBN	206	D2234-LBC-15S	211
98001306-T-64	317	990312	180	D2211-LBN-S	211	D2234-LBC-25	206
98001306-T-82	323	990331	180	D2212-LBC	206	D2234-LBC-25S	211
98001307-T-43	313	990332	180	D2212-LBC-S	211	D2234-LBC-40	206
98001307-T-64	317	990341	180	D2212-LBN	206	D2234-LBC-40S	211
98001307-T-82	323	990342	180	D2212-LBN-S	211	D2234-LBN-15	206
980016-I-43	313	990351	181	D2213-LBC	207	D2234-LBN-15S	211
980016-I-64	317	990352	181	D2213-LBC-S	213	D2234-LBN-25	206
980017-P-43	313	990371	180	D2213-LBN	207	D2234-LBN-25S	211
980017-P-64	317	990372	180	D2213-LBN-S	213	D2234-LBN-40	206
980017-P-82	323	990381	183	D2214-LBC	207	D2234-LBN-40S	211
980019	313	990382	183	D2214-LBC-S	213	D2235-LBC-15	206
980052	313	990741	180	D2214-LBN	207	D2235-LBC-15S	211
980073	329	990742	180	D2214-LBN-S	213	D2235-LBC-25	206
980074	329	990751	181	D2215-LBC	207	D2235-LBC-25S	211
980075	329	990752	181	D2215-LBC-S	213	D2235-LBC-40	206
980076	329	990781	180	D2215-LBN	207	D2235-LBC-40S	211
980077	331	990782	180	D2215-LBN-S	213	D2235-LBN-15	206
980078	329	990791	180	D2216-MLBC-25	206	D2235-LBN-15S	211
980079	335	990792	180	D2216-MLBC25S	211	D2235-LBN-25	206
980080	335	990831	181	D2216-MLBC-40	206	D2235-LBN-25S	211
980081	335	990832	181	D2216-MLBC40S	211	D2235-LBN-40	206
980082	330	990921	181	D2216-MLBN-25	206	D2235-LBN-40S	211
980083	333	990922	181	D2216-MLBN25S	211	D2236-LBC-15	206

■■■■ COD.	PAG.	■■■■ COD.	PAG.	■■■■ COD.	PAG.	■■■■ COD.	PAG.
D2236-LBC-15S	211	E1027-LBN-40	593	E1220-LBN	467	E4085-LBC	505
D2236-LBC-25	206	E1028-LBC-15	593	E1221-LBC	467	E4085-LBN	505
D2236-LBC-25S	211	E1028-LBC-25	593	E1221-LBN	467	E4100-LBC	653
D2236-LBC-40	206	E1028-LBC-40	593	E1222-LBC	467	E4100-LBN	653
D2236-LBC-40S	211	E1028-LBN-15	593	E1222-LBN	467	E4101-LBC	653
D2236-LBN-15	206	E1028-LBN-25	593	E1223-LBC	467	E4101-LBN	653
D2236-LBN-15S	211	E1028-LBN-40	593	E1223-LBN	467	E4102-LBC	653
D2236-LBN-25	206	E1030	593	E1224-LBC	467	E4102-LBN	653
D2236-LBN-25S	211	E1035	589	E1224-LBN	467	E4111-LBC	505
D2236-LBN-40	206	E1036	589	E4010-LBC	561	E4111-LBN	505
D2236-LBN-40S	211	E1037	589	E4010-LBN	561	E4112-LBC	505
D2237-LBC-15	207	E1038	591	E4011-LBC	561	E4112-LBN	505
D2237-LBC-15S	213	E1039	591	E4011-LBN	561	E4113-LBC	505
D2237-LBC-25	207	E1067	591	E4050	561	E4113-LBN	505
D2237-LBC-25S	213	E1068	591	E4052	561	E4900-LBC-1L	507
D2237-LBC-40	207	E1069	591	E4054	561	E4900-LBC-M	506
D2237-LBC-40S	213	E1070	591	E4055	561	E4900-LBN-1L	507
D2237-LBN-15	207	E1071	591	E4056-3	561	E4900-LBN-M	506
D2237-LBN-15S	213	E1072	591	E4056-3	635	E4901-LBC-1L	507
D2237-LBN-25	207	E1074-LBC	591	E4056-6	561	E4901-LBC-M	506
D2237-LBN-25S	213	E1074-LBN	591	E4056-6	635	E4901-LBN-1L	507
D2237-LBN-40	207	E1075-LBC	591	E4068AS-LBC	651	E4901-LBN-M	506
D2237-LBN-40S	213	E1075-LBN	591	E4068AS-LBN	651	E4902-LBC-1L	507
D2238-LBC-15	207	E1076-LBC	591	E4068-LBC	651	E4902-LBC-M	506
D2238-LBC-15S	213	E1076-LBN	591	E4068-LBN	651	E4902-LBN-1L	507
D2238-LBC-25	207	E1077-LBC	591	E4069AS-LBC	651	E4902-LBN-M	506
D2238-LBC-25S	213	E1077-LBN	591	E4069AS-LBN	651	E4905-LBC-2L	507
D2238-LBC-40	207	E1078-LBC	591	E4069-LBC	651	E4905-LBN-2L	507
D2238-LBC-40S	213	E1078-LBN	591	E4069-LBN	651	E4906-LBC-2L	507
D2238-LBN-15	207	E1079-LBC	591	E4070AS-LBC	651	E4906-LBN-2L	507
D2238-LBN-15S	213	E1079-LBN	591	E4070AS-LBN	651	E4907-LBC-2L	507
D2238-LBN-25	207	E1080-LBC	591	E4070-LBC	651	E4907-LBN-2L	507
D2238-LBN-25S	213	E1080-LBN	591	E4070-LBN	651	E4910-LBC-1L	509
D2238-LBN-40	207	E1081-LBC	591	E4071AS-LBC	651	E4910-LBC-M	508
D2238-LBN-40S	213	E1081-LBN	591	E4071AS-LBN	651	E4910-LBN-1L	509
D2239-LBC-15	207	E1082-LBC	591	E4071-LBC	651	E4910-LBN-M	508
D2239-LBC-15S	213	E1082-LBN	591	E4071-LBN	651	E4911-LBC-1L	509
D2239-LBC-25	207	E1085-LBC-10	589	E4072AS-LBC	651	E4911-LBC-M	508
D2239-LBC-25S	213	E1085-LBC-25	589	E4072AS-LBN	651	E4911-LBN-1L	509
D2239-LBC-40	207	E1085-LBN-10	589	E4072-LBC	651	E4911-LBN-M	508
D2239-LBC-40S	213	E1085-LBN-25	589	E4072-LBN	651	E4912-LBC-1L	509
D2239-LBN-15	207	E1086-LBC-10	589	E4073AS-LBC	651	E4912-LBC-M	508
D2239-LBN-15S	213	E1086-LBC-25	589	E4073AS-LBN	651	E4912-LBN-1L	509
D2239-LBN-25	207	E1086-LBN-10	589	E4073-LBC	651	E4912-LBN-M	508
D2239-LBN-25S	213	E1086-LBN-25	589	E4073-LBN	651	E4915-LBC-2L	509
D2239-LBN-40	207	E1087-LBC-10	589	E4074AS-LBC	651	E4915-LBN-2L	509
D2239-LBN-40S	213	E1087-LBC-25	589	E4074AS-LBN	651	E4916-LBC-2L	509
E100	611	E1087-LBN-10	589	E4074-LBC	651	E4916-LBN-2L	509
E101	610	E1087-LBN-25	589	E4074-LBN	651	E4917-LBC-2L	509
E1010-RGB-10	593	E1118-LBC	559	E4075AS-LBC	651	E4917-LBN-2L	509
E1010-RGB-30	593	E1118-LBI	559	E4075AS-LBN	651	E5191	632
E1010-RGB-45	593	E1118-RGB	559	E4075-LBC	651	E5191-2	633
E1010-RGBW-20	593	E1119-LBC	559	E4075-LBN	651	E5192	632
E1010-RGBW-35	593	E1119-LBI	559	E4076AS-LBC	651	E5192-2	633
E1011-RGB-10	593	E1119-RGB	559	E4076AS-LBN	651	E5193	632
E1011-RGB-30	593	E1120-LBC	559	E4076-LBC	651	E5193-2	633
E1011-RGB-45	593	E1120-LBI	559	E4076-LBN	651	E5195	632
E102	610	E1120-RGB	559	E4083AS-LBC	505	E5195-2	633
E1020	593	E1124-LBC	559	E4083AS-LBN	505	E5196	632
E1021	593	E1124-LBI	559	E4083-LBC	505	E5196-2	633
E1025	593	E1125-LBC	559	E4083-LBN	505	E5197	632
E1026	593	E1125-LBI	559	E4084AS-LBC	505	E5197-2	633
E1027-LBC-15	593	E1126-LBC	559	E4084AS-LBN	505	E5313-LBC	493
E1027-LBC-25	593	E1126-LBI	559	E4084-LBC	505	E5313-LBN	493
E1027-LBC-40	593	E1219-LBC	467	E4084-LBN	505	E5314-LBC	493
E1027-LBN-15	593	E1219-LBN	467	E4085AS-LBC	505	E5314-LBN	493
E1027-LBN-25	593	E1220-LBC	467	E4085AS-LBN	505	E5315-LBC	493

COD.	PAG.	COD.	PAG.	COD.	PAG.	COD.	PAG.
E5315-LBN	493	E5386-LBN	535	E5430-LBN-EM	529	E5556C-LBC-24	543
E5345-LBC	493	E5386-LBN-EM	535	E5431-LBC	529	E5556C-LBC24S	547
E5345-LBN	493	E5387-LBC	535	E5431-LBC-EM	529	E5556C-LBC-40	543
E5346-LBC	493	E5387-LBC-EM	535	E5431-LBI	529	E5556C-LBC40S	547
E5346-LBN	493	E5387-LBN	535	E5431-LBN	529	E5556C-LBC40S	547
E5347-LBC	493	E5387-LBN-EM	535	E5431-LBN-EM	529	E5556C-LBN-15	543
E5347-LBN	493	E5390-LBC	535	E5432-LBC	529	E5556C-LBN15S	547
E5357-LBC-15	541	E5390-LBC-EM	535	E5432-LBC-EM	529	E5556C-LBN-24	543
E5357-LBC-40	541	E5390-LBN	535	E5432-LBI	529	E5556C-LBN24S	547
E5357-LBC-60	541	E5390-LBN-EM	535	E5432-LBN	529	E5556C-LBN-40	543
E5357-LBN-15	541	E5391-LBC	535	E5432-LBN-EM	529	E5557C-LBC-15	543
E5357-LBN-40	541	E5391-LBC-EM	535	E5446-LBC	530	E5557C-LBC15S	547
E5357-LBN-60	541	E5391-LBN	535	E5446-LBC-EM	530	E5557C-LBC-24	543
E5358-LBC-15	541	E5391-LBN-EM	535	E5446-LBI	530	E5557C-LBC24S	547
E5358-LBC-40	541	E5392-LBC	535	E5446-LBI-EM	530	E5557C-LBC-40	543
E5358-LBC-60	541	E5392-LBC-EM	535	E5446-LBN	530	E5557C-LBC40S	547
E5358-LBN-15	541	E5392-LBN	535	E5446-LBN-EM	530	E5557C-LBC40S	547
E5358-LBN-40	541	E5392-LBN-EM	535	E5447-LBC	530	E5557C-LBN-15	543
E5358-LBN-60	541	E5393-LBC	535	E5447-LBC-EM	530	E5557C-LBN15S	547
E5359-LBC-15	541	E5393-LBN	535	E5447-LBI	530	E5557C-LBN-24	543
E5359-LBC-40	541	E5394-LBC	535	E5447-LBI-EM	530	E5557C-LBN24S	547
E5359-LBC-60	541	E5394-LBN	535	E5447-LBN	530	E5557C-LBN-40	543
E5359-LBN-15	541	E5395-LBC	535	E5447-LBN-EM	530	E5558C-LBC-15	543
E5359-LBN-40	541	E5395-LBN	535	E5448-LBC	530	E5558C-LBC15S	547
E5359-LBN-60	541	E5396-LBC	535	E5448-LBC-EM	530	E5558C-LBC-24	543
E5375-LBC-15	519	E5396-LBN	535	E5448-LBI	530	E5558C-LBC24S	547
E5375-LBC-40	519	E5397-LBC	535	E5448-LBI-EM	530	E5558C-LBC-40	543
E5375-LBC-60	519	E5397-LBN	535	E5448-LBN	530	E5558C-LBC40S	547
E5375-LBN-15	519	E5398-LBC	535	E5448-LBN-EM	530	E5558C-LBC40S	547
E5375-LBN-40	519	E5398-LBN	535	E5550C-LBC-15	510	E5558C-LBN-15	543
E5375-LBN-60	519	E5400-LBC	531	E5550C-LBC-24	510	E5558C-LBN15S	547
E5376-LBC-15	519	E5400-LBC-DA	531	E5550C-LBC-40	510	E5558C-LBN-24	543
E5376-LBC-40	519	E5400-LBC-DIM	531	E5550C-LBN-15	510	E5558C-LBN24S	547
E5376-LBC-60	519	E5400-LBN	531	E5550C-LBN-24	510	E5558C-LBN-40	543
E5376-LBN-15	519	E5400-LBN-DA	531	E5550C-LBN-40	510	E5590-LBC-16	511
E5376-LBN-40	519	E5400-LBN-DIM	531	E5551C-LBC-15	510	E5590-LBC-24	511
E5376-LBN-60	519	E5401-LBC	531	E5551C-LBC-24	510	E5590-LBC-40	511
E5377-LBC-15	519	E5401-LBC-DA	531	E5551C-LBC-40	510	E5590-LBC-AS	511
E5377-LBC-40	519	E5401-LBC-DIM	531	E5551C-LBN-15	510	E5590-LBN-16	511
E5377-LBC-60	519	E5401-LBN	531	E5551C-LBN-24	510	E5590-LBN-24	511
E5377-LBN-15	519	E5401-LBN-DA	531	E5551C-LBN-40	510	E5590-LBN-40	511
E5377-LBN-40	519	E5401-LBN-DIM	531	E5552C-LBC-15	510	E5590-LBN-AS	511
E5377-LBN-60	519	E5402-LBC	531	E5552C-LBC-24	510	E5591-LBC-16	511
E5381-LBC-15	521	E5402-LBC-DA	531	E5552C-LBC-40	510	E5591-LBC-24	511
E5381-LBC-40	521	E5402-LBC-DIM	531	E5552C-LBN-15	510	E5591-LBC-40	511
E5381-LBC-60	521	E5402-LBN	531	E5552C-LBN-24	510	E5591-LBC-AS	511
E5381-LBN-15	521	E5402-LBN-DA	531	E5552C-LBN-40	510	E5591-LBN-16	511
E5381-LBN-40	521	E5402-LBN-DIM	531	E5553C-LBC-15	515	E5591-LBN-24	511
E5381-LBN-60	521	E5420-LBC	529	E5553C-LBC-24	515	E5591-LBN-40	511
E5382-LBC-15	521	E5420-LBC-EM	529	E5553C-LBC-40	515	E5591-LBN-AS	511
E5382-LBC-40	521	E5420-LBI	529	E5553C-LBN-15	515	E5592-LBC-16	511
E5382-LBC-60	521	E5420-LBN	529	E5553C-LBN-24	515	E5592-LBC-24	511
E5382-LBN-15	521	E5420-LBN-EM	529	E5553C-LBN-40	515	E5592-LBC-40	511
E5382-LBN-40	521	E5421-LBC	529	E5554C-LBC-15	515	E5592-LBC-AS	511
E5382-LBN-60	521	E5421-LBC-EM	529	E5554C-LBC-24	515	E5592-LBN-16	511
E5383-LBC-15	521	E5421-LBI	529	E5554C-LBC-40	515	E5592-LBN-24	511
E5383-LBC-40	521	E5421-LBN	529	E5554C-LBN-15	515	E5592-LBN-40	511
E5383-LBC-60	521	E5421-LBN-EM	529	E5554C-LBN-24	515	E5592-LBN-AS	511
E5383-LBN-15	521	E5422-LBC	529	E5554C-LBN-40	515	E5593-LBC-16	516
E5383-LBN-40	521	E5422-LBC-EM	529	E5555C-LBC-15	515	E5593-LBC-24	516
E5383-LBN-60	521	E5422-LBI	529	E5555C-LBC-24	515	E5593-LBC-40	516
E5385-LBC	535	E5422-LBN	529	E5555C-LBC-40	515	E5593-LBC-AS	516
E5385-LBC-EM	535	E5422-LBN-EM	529	E5555C-LBN-15	515	E5593-LBN-16	516
E5385-LBN	535	E5430-LBC	529	E5555C-LBN-24	515	E5593-LBN-24	516
E5385-LBN-EM	535	E5430-LBC-EM	529	E5555C-LBN-40	515	E5593-LBN-40	516
E5386-LBC	535	E5430-LBI	529	E5556C-LBC-15	543	E5593-LBN-AS	516
E5386-LBC-EM	535	E5430-LBN	529	E5556C-LBC15S	547	E5594-LBC-16	516

■■■■ COD.	PAG.	■■■■ COD.	PAG.	■■■■ COD.	PAG.	■■■■ COD.	PAG.
E5594-LBC-24	516	E5680-LBC-16	513	E5688-LBN-16S	549	E5860T-LBN-30	600
E5594-LBC-40	516	E5680-LBC-24	513	E5688-LBN-25	545	E5860T-LBN-45	600
E5594-LBC-AS	516	E5680-LBC-40	513	E5688-LBN-25S	549	E5861Q-LBC-10	602
E5594-LBN-16	516	E5680-LBN-16	513	E5688-LBN-40	545	E5861Q-LBC-30	602
E5594-LBN-24	516	E5680-LBN-24	513	E5688-LBN-40S	549	E5861Q-LBC-45	602
E5594-LBN-40	516	E5680-LBN-40	513	E5690-LBC	649	E5861Q-LBL-10	602
E5594-LBN-AS	516	E5681-LBC-16	513	E5690-LBC-DA	649	E5861Q-LBL-30	602
E5595-LBC-16	516	E5681-LBC-24	513	E5690-LBN	649	E5861Q-LBL-45	602
E5595-LBC-24	516	E5681-LBC-40	513	E5690-LBN-DA	649	E5861Q-LBN-10	602
E5595-LBC-40	516	E5681-LBN-16	513	E5691-LBC	649	E5861Q-LBN-30	602
E5595-LBC-AS	516	E5681-LBN-24	513	E5691-LBC-DA	649	E5861Q-LBN-45	602
E5595-LBN-16	516	E5681-LBN-40	513	E5691-LBN	649	E5861T-LBC-10	600
E5595-LBN-24	516	E5682-LBC-16	513	E5691-LBN-DA	649	E5861T-LBC-30	600
E5595-LBN-40	516	E5682-LBC-24	513	E5692-LBC	649	E5861T-LBC-45	600
E5595-LBN-AS	516	E5682-LBC-40	513	E5692-LBC-DA	649	E5861T-LBL-10	600
E5596-LBC-16	544	E5682-LBN-16	513	E5692-LBN	649	E5861T-LBL-30	600
E5596-LBC-16S	548	E5682-LBN-24	513	E5692-LBN-DA	649	E5861T-LBL-45	600
E5596-LBC-24	544	E5682-LBN-40	513	E5693-LBC	649	E5861T-LBN-10	600
E5596-LBC-24S	548	E5683-LBC-16	517	E5693-LBC-DA	649	E5861T-LBN-30	600
E5596-LBC-40	544	E5683-LBC-25	517	E5693-LBN	649	E5861T-LBN-45	600
E5596-LBC-40S	548	E5683-LBC-40	517	E5693-LBN-DA	649	E5862Q-LBC-10	602
E5596-LBN-16	544	E5683-LBN-16	517	E5810-LBC	523	E5862Q-LBC-30	602
E5596-LBN-16S	548	E5683-LBN-25	517	E5810-LBN	523	E5862Q-LBC-45	602
E5596-LBN-24	544	E5683-LBN-40	517	E5811-LBC	523	E5862Q-LBL-10	602
E5596-LBN-24S	548	E5684-LBC-16	517	E5811-LBN	523	E5862Q-LBL-30	602
E5596-LBN-40	544	E5684-LBC-25	517	E5812-LBC	523	E5862Q-LBL-45	602
E5596-LBN-40S	548	E5684-LBC-40	517	E5812-LBN	523	E5862Q-LBN-10	602
E5597-LBC-16	544	E5684-LBN-16	517	E5830-LBC	523	E5862Q-LBN-30	602
E5597-LBC-16S	548	E5684-LBN-25	517	E5830-LBN	523	E5862Q-LBN-45	602
E5597-LBC-24	544	E5684-LBN-40	517	E5831-LBC	523	E5862T-LBC-10	600
E5597-LBC-24S	548	E5685-LBC-16	517	E5831-LBN	523	E5862T-LBC-30	600
E5597-LBC-40	544	E5685-LBC-25	517	E5832-LBC	523	E5862T-LBC-45	600
E5597-LBC-40S	548	E5685-LBC-40	517	E5832-LBN	523	E5862T-LBL-10	600
E5597-LBN-16	544	E5685-LBN-16	517	E5850-LBC	522	E5862T-LBL-30	600
E5597-LBN-16S	548	E5685-LBN-25	517	E5850-LBI	522	E5862T-LBL-45	600
E5597-LBN-24	544	E5685-LBN-40	517	E5850-LBN	522	E5862T-LBN-10	600
E5597-LBN-24S	548	E5686-LBC-16	545	E5851-LBC	522	E5862T-LBN-30	600
E5597-LBN-40	544	E5686-LBC-16S	549	E5851-LBI	522	E5862T-LBN-45	600
E5597-LBN-40S	548	E5686-LBC-25	545	E5851-LBN	522	E5863Q-LBC-10	602
E5598-LBC-16	544	E5686-LBC-25S	549	E5852-LBC	522	E5863Q-LBC-30	602
E5598-LBC-16S	548	E5686-LBC-40	545	E5852-LBI	522	E5863Q-LBC-45	602
E5598-LBC-24	544	E5686-LBC-40S	549	E5852-LBN	522	E5863Q-LBL-10	602
E5598-LBC-24S	548	E5686-LBN-16	545	E5853-LBC	522	E5863Q-LBL-30	602
E5598-LBC-40	544	E5686-LBN-16S	549	E5853-LBI	522	E5863Q-LBL-45	602
E5598-LBC-40S	548	E5686-LBN-25	545	E5853-LBN	522	E5863Q-LBN-10	602
E5598-LBN-16	544	E5686-LBN-25S	549	E5854-LBC	522	E5863Q-LBN-30	602
E5598-LBN-16S	548	E5686-LBN-40	545	E5854-LBI	522	E5863Q-LBN-45	602
E5598-LBN-24	544	E5686-LBN-40S	549	E5854-LBN	522	E5863T-LBC-10	600
E5598-LBN-24S	548	E5687-LBC-16	545	E5855-LBC	522	E5863T-LBC-30	600
E5598-LBN-40	544	E5687-LBC-16S	549	E5855-LBI	522	E5863T-LBC-45	600
E5598-LBN-40S	548	E5687-LBC-25	545	E5855-LBN	522	E5863T-LBL-10	600
E5652	647	E5687-LBC-25S	549	E5860Q-LBC-10	602	E5863T-LBL-30	600
E5653	647	E5687-LBC-40	545	E5860Q-LBC-30	602	E5863T-LBL-45	600
E5654	647	E5687-LBC-40S	549	E5860Q-LBC-45	602	E5863T-LBN-10	600
E5655	647	E5687-LBN-16	545	E5860Q-LBL-10	602	E5863T-LBN-30	600
E5656	647	E5687-LBN-16S	549	E5860Q-LBL-30	602	E5863T-LBN-45	600
E5657	647	E5687-LBN-25	545	E5860Q-LBL-45	602	E5864Q-LBC-10	602
E5658	647	E5687-LBN-25S	549	E5860Q-LBN-10	602	E5864Q-LBC-30	602
E5659	647	E5687-LBN-40	545	E5860Q-LBN-30	602	E5864Q-LBC-45	602
E5676-LBC	647	E5687-LBN-40S	549	E5860Q-LBN-45	602	E5864Q-LBL-10	602
E5676-LBN	647	E5688-LBC-16	545	E5860T-LBC-10	600	E5864Q-LBL-30	602
E5677-LBC	647	E5688-LBC-16S	549	E5860T-LBC-30	600	E5864Q-LBL-45	602
E5677-LBN	647	E5688-LBC-25	545	E5860T-LBC-45	600	E5864Q-LBN-10	602
E5678-LBC	647	E5688-LBC-25S	549	E5860T-LBL-10	600	E5864Q-LBN-30	602
E5678-LBN	647	E5688-LBC-40	545	E5860T-LBL-30	600	E5864Q-LBN-45	602
E5679-LBC	647	E5688-LBC-40S	549	E5860T-LBL-45	600	E5864T-LBC-10	600
E5679-LBN	647	E5688-LBN-16	545	E5860T-LBN-10	600	E5864T-LBC-30	600

COD.	PAG.	COD.	PAG.	COD.	PAG.	COD.	PAG.
E5864T-LBC-45	600	E5868Q-LBN-10	603	E5875-LBN	497	E5920-LBC	645
E5864T-LBL-10	600	E5868Q-LBN-30	603	E5876-LBC	497	E5920-LBN	645
E5864T-LBL-30	600	E5868Q-LBN-45	603	E5876-LBN	497	E5921-LBC	645
E5864T-LBL-45	600	E5868T-LBC-10	601	E5877-LBC	497	E5921-LBN	645
E5864T-LBN-10	600	E5868T-LBC-30	601	E5877-LBN	497	E5922-LBC	645
E5864T-LBN-30	600	E5868T-LBC-45	601	E5878-LBC	497	E5922-LBN	645
E5864T-LBN-45	600	E5868T-LBL-10	601	E5878-LBN	497	E5923-LBC	645
E5865Q-LBC-10	602	E5868T-LBL-30	601	E5879-LBC	497	E5923-LBN	645
E5865Q-LBC-30	602	E5868T-LBL-45	601	E5879-LBN	497	E5925-LBC	645
E5865Q-LBC-45	602	E5868T-LBN-10	601	E5880-LBC	497	E5925-LBN	645
E5865Q-LBL-10	602	E5868T-LBN-30	601	E5880-LBN	497	E5926-LBC	645
E5865Q-LBL-30	602	E5868T-LBN-45	601	E5881-LBC	495	E5926-LBN	645
E5865Q-LBL-45	602	E5869Q-LBC-10	603	E5881-LBN	495	E5927-LBC	645
E5865Q-LBN-10	602	E5869Q-LBC-30	603	E5882-LBC	495	E5927-LBN	645
E5865Q-LBN-30	602	E5869Q-LBC-45	603	E5882-LBN	495	E5928-LBC	645
E5865Q-LBN-45	602	E5869Q-LBL-10	603	E5883-LBC	495	E5928-LBN	645
E5865T-LBC-10	600	E5869Q-LBL-30	603	E5883-LBN	495	E5930-LBC	645
E5865T-LBC-30	600	E5869Q-LBL-45	603	E5884-LBC	495	E5930-LBN	645
E5865T-LBC-45	600	E5869Q-LBN-10	603	E5884-LBN	495	E5931-LBC	645
E5865T-LBL-10	600	E5869Q-LBN-30	603	E5885-LBC	495	E5931-LBN	645
E5865T-LBL-30	600	E5869Q-LBN-45	603	E5885-LBN	495	E5932-LBC	645
E5865T-LBL-45	600	E5869T-LBC-10	601	E5886-LBC	495	E5932-LBN	645
E5865T-LBN-10	600	E5869T-LBC-30	601	E5886-LBN	495	E5933-LBC	645
E5865T-LBN-30	600	E5869T-LBC-45	601	E5887-LBC	494	E5933-LBN	645
E5865T-LBN-45	600	E5869T-LBL-10	601	E5887-LBN	494	E5940-LBC	645
E5866Q-LBC-10	602	E5869T-LBL-30	601	E5888-LBC	494	E5940-LBN	645
E5866Q-LBC-30	602	E5869T-LBL-45	601	E5888-LBN	494	E5941-LBC	645
E5866Q-LBC-45	602	E5869T-LBN-10	601	E5889-LBC	494	E5941-LBN	645
E5866Q-LBL-10	602	E5869T-LBN-30	601	E5889-LBN	494	E5942-LBC	645
E5866Q-LBL-30	602	E5869T-LBN-45	601	E5890-LBC	494	E5942-LBN	645
E5866Q-LBL-45	602	E5870Q-LBC-10	603	E5890-LBN	494	E5943-LBC	645
E5866Q-LBN-10	602	E5870Q-LBC-30	603	E5891-LBC	494	E5943-LBN	645
E5866Q-LBN-30	602	E5870Q-LBC-45	603	E5891-LBN	494	E5945-LBC	645
E5866Q-LBN-45	602	E5870Q-LBL-10	603	E5892-LBC	494	E5945-LBN	645
E5866T-LBC-10	600	E5870Q-LBL-30	603	E5892-LBN	494	E5946-LBC	645
E5866T-LBC-30	600	E5870Q-LBL-45	603	E5900-LBC	643	E5946-LBN	645
E5866T-LBC-45	600	E5870Q-LBN-10	603	E5900-LBN	643	E5947-LBC	645
E5866T-LBL-10	600	E5870Q-LBN-30	603	E5901-LBC	643	E5947-LBN	645
E5866T-LBL-30	600	E5870Q-LBN-45	603	E5901-LBN	643	E5948-LBC	645
E5866T-LBL-45	600	E5870T-LBC-10	601	E5902-LBC	643	E5948-LBN	645
E5866T-LBN-10	600	E5870T-LBC-30	601	E5902-LBN	643	E5950-LBC	645
E5866T-LBN-30	600	E5870T-LBC-45	601	E5903-LBC	643	E5950-LBN	645
E5866T-LBN-45	600	E5870T-LBL-10	601	E5903-LBN	643	E5951-LBC	645
E5867Q-LBC-10	602	E5870T-LBL-30	601	E5905-LBC	643	E5951-LBN	645
E5867Q-LBC-30	602	E5870T-LBL-45	601	E5905-LBN	643	E5952-LBC	645
E5867Q-LBC-45	602	E5870T-LBN-10	601	E5906-LBC	643	E5952-LBN	645
E5867Q-LBL-10	602	E5870T-LBN-30	601	E5906-LBN	643	E5953-LBC	645
E5867Q-LBL-30	602	E5870T-LBN-45	601	E5907-LBC	643	E5953-LBN	645
E5867Q-LBL-45	602	E5871Q-LBC-10	603	E5907-LBN	643	E6000-LBN	277
E5867Q-LBN-10	602	E5871Q-LBC-30	603	E5908-LBC	643	E6000-LBN	563
E5867Q-LBN-30	602	E5871Q-LBC-45	603	E5908-LBN	643	E6000LBN-DA	277
E5867Q-LBN-45	602	E5871Q-LBL-10	603	E5910-LBC	643	E6000-LBN-DA	563
E5867T-LBC-10	600	E5871Q-LBL-30	603	E5910-LBN	643	E6000LBN-DA-P	277
E5867T-LBC-30	600	E5871Q-LBL-45	603	E5911-LBC	643	E6000LBN-DA-P	563
E5867T-LBC-45	600	E5871Q-LBN-10	603	E5911-LBN	643	E6000-LBN-P	277
E5867T-LBL-10	600	E5871Q-LBN-30	603	E5912-LBC	643	E6000-LBN-P	563
E5867T-LBL-30	600	E5871Q-LBN-45	603	E5912-LBN	643	E6001-LBN	277
E5867T-LBL-45	600	E5871T-LBC-10	601	E5913-LBC	643	E6001-LBN	563
E5867T-LBN-10	600	E5871T-LBC-30	601	E5913-LBN	643	E6001LBN-DA	277
E5867T-LBN-30	600	E5871T-LBC-45	601	E5915-LBC	643	E6001-LBN-DA	563
E5867T-LBN-45	600	E5871T-LBL-10	601	E5915-LBN	643	E6001LBN-DA-P	277
E5868Q-LBC-10	603	E5871T-LBL-30	601	E5916-LBC	643	E6001LBN-DA-P	563
E5868Q-LBC-30	603	E5871T-LBL-45	601	E5916-LBN	643	E6001-LBN-P	277
E5868Q-LBC-45	603	E5871T-LBN-10	601	E5917-LBC	643	E6001-LBN-P	563
E5868Q-LBL-10	603	E5871T-LBN-30	601	E5917-LBN	643	E6002	277
E5868Q-LBL-30	603	E5871T-LBN-45	601	E5918-LBC	643	E6003-LBN	277
E5868Q-LBL-45	603	E5875-LBC	497	E5918-LBN	643	E6003-LBN	563

■■■■ COD.	PAG.	■■■■ COD.	PAG.	■■■■ COD.	PAG.	■■■■ COD.	PAG.
E6003-LBN-P	277	E67895-LBC-S	587	E7120C-LBC40	392	E8129-LBC-ASI	414
E6003-LBN-P	563	E67895-LBC-WF	587	E7120C-LBN15	392	E8129-LBC-ASI-ST	421
E6005-LBN	277	E67895-LBN-FL	587	E7120C-LBN24	392	E8129-LBC-FL	407
E6005-LBN	563	E67895-LBN-S	587	E7120C-LBN40	392	E8129-LBC-FL-ST	423
E6005LBN-DA	277	E67895-LBN-WF	587	E8004	579	E8129-LBC-S	407
E6005-LBN-DA	563	E67896-LBC-FL	587	E8005	579	E8129-LBC-S-ST	423
E6005LBN-DA-P	277	E67896-LBC-S	587	E8007	579	E8129-LBC-WF	407
E6005LBN-DA-P	563	E67896-LBC-WF	587	E8008	581	E8129-LBC-WF-ST	423
E6005-LBN-P	277	E67896-LBN-FL	587	E8009	581	E8129-LBN-12	414
E6005-LBN-P	563	E67896-LBN-S	587	E8040-LBC	501	E8129-LBN-12-ST	421
E6006-LBN	277	E67896-LBN-WF	587	E8040-LBI	501	E8129-LBN-55	414
E6006-LBN	563	E67897-LBC-FL	587	E8040-LBN	501	E8129-LBN-55-ST	421
E6006LBN-DA	277	E67897-LBC-S	587	E8046-LBC	501	E8129-LBN-75	414
E6006-LBN-DA	563	E67897-LBC-WF	587	E8046-LBI	501	E8129-LBN-75-ST	421
E6006LBN-DA-P	277	E67897-LBN-FL	587	E8046-LBN	501	E8129-LBN-AE	414
E6006LBN-DA-P	563	E67897-LBN-S	587	E8050-LBC	501	E8129-LBN-AE-ST	421
E6006-LBN-P	277	E67897-LBN-WF	587	E8050-LBI	501	E8129-LBN-AS	407
E6006-LBN-P	563	E67898-LBC-FL	587	E8050-LBN	501	E8129-LBN-ASI	414
E6007-LBN	277	E67898-LBC-S	587	E8065-LBC	500	E8129-LBN-ASI-ST	421
E6007-LBN	563	E67898-LBC-WF	587	E8065-LBN	500	E8129-LBN-FL	407
E6007-LBN-P	277	E67898-LBN-FL	587	E8066-LBC	500	E8129-LBN-FL-ST	423
E6007-LBN-P	563	E67898-LBN-S	587	E8066-LBN	500	E8129-LBN-S	407
E6009-LBN	277	E67898-LBN-WF	587	E8067-LBC	500	E8129-LBN-S-ST	423
E6009-LBN	563	E67900-LBC-FL	585	E8067-LBN	500	E8129-LBN-WF	407
E6009-LBN-P	277	E67900-LBC-S	585	E81281-LBC-AS	477	E8129-LBN-WF-ST	423
E6009-LBN-P	563	E67900-LBC-WF	585	E81281-LBC-FL	477	E8131T-LBC-AS	405
E6010-LBN	277	E67900-LBN-FL	585	E81281-LBC-S	477	E8131T-LBC-FL	405
E6010-LBN	563	E67900-LBN-S	585	E81281-LBC-WF	477	E8131T-LBC-S	405
E6010LBN-DA	277	E67900-LBN-WF	585	E81281-LBN-AS	477	E8131T-LBC-WF	405
E6010-LBN-DA	563	E67901-LBC-FL	585	E81281-LBN-FL	477	E8131T-LBN-AS	405
E6010LBN-DA-P	277	E67901-LBC-S	585	E81281-LBN-S	477	E8131T-LBN-FL	405
E6010LBN-DA-P	563	E67901-LBC-WF	585	E81281-LBN-WF	477	E8131T-LBN-S	405
E6010-LBN-P	277	E67901-LBN-FL	585	E8128-LBC-AS	403	E8131T-LBN-WF	405
E6010-LBN-P	563	E67901-LBN-S	585	E8128-LBC-FL	403	E8132F-LBC-12	415
E6011-LBN	277	E67901-LBN-WF	585	E8128-LBC-S	403	E8132F-LBC-55	415
E6011-LBN	563	E67902-LBC-FL	585	E8128-LBC-WF	403	E8132F-LBC-75	415
E6011LBN-DA	277	E67902-LBC-S	585	E8128-LBN-AS	403	E8132F-LBC-AE	415
E6011-LBN-DA	563	E67902-LBC-WF	585	E8128-LBN-FL	403	E8132F-LBC-ASI	415
E6011LBN-DA-P	277	E67902-LBN-FL	585	E8128-LBN-S	403	E8132F-LBN-12	415
E6011LBN-DA-P	563	E67902-LBN-S	585	E8128-LBN-WF	403	E8132F-LBN-55	415
E6011-LBN-P	277	E67902-LBN-WF	585	E8129F-LBC-12	414	E8132F-LBN-75	415
E6011-LBN-P	563	E67903-LBC-FL	585	E8129F-LBC-55	414	E8132F-LBN-AE	415
E67886-LBC-FL	586	E67903-LBC-S	585	E8129F-LBC-75	414	E8132F-LBN-ASI	415
E67886-LBC-S	586	E67903-LBC-WF	585	E8129F-LBC-AE	414	E8132-LBC-AS	409
E67886-LBC-WF	586	E67903-LBN-FL	585	E8129F-LBC-ASI	414	E8132-LBC-FL	409
E67886-LBN-FL	586	E67903-LBN-S	585	E8129F-LBN-12	414	E8132-LBC-S	409
E67886-LBN-S	586	E67903-LBN-WF	585	E8129F-LBN-55	414	E8132-LBC-WF	409
E67886-LBN-WF	586	E67910-LBC-FL	583	E8129F-LBN-75	414	E8132-LBN-AS	409
E67887-LBC-FL	586	E67910-LBC-S	583	E8129F-LBN-AE	414	E8132-LBN-FL	409
E67887-LBC-S	586	E67910-LBN-FL	583	E8129F-LBN-ASI	414	E8132-LBN-S	409
E67887-LBC-WF	586	E67910-LBN-S	583	E8129I-LBN-WF	479	E8132-LBN-WF	409
E67887-LBN-FL	586	E67911-LBC-FL	583	E8129I-LBC-AS	479	E8132T-LBC-AS	407
E67887-LBN-S	586	E67911-LBC-S	583	E8129I-LBC-FL	479	E8132T-LBC-FL	407
E67887-LBN-WF	586	E67911-LBN-FL	583	E8129I-LBC-S	479	E8132T-LBC-S	407
E67888-LBC-FL	586	E67911-LBN-S	583	E8129I-LBC-WF	479	E8132T-LBC-WF	407
E67888-LBC-S	586	E67912-LBC-FL	583	E8129I-LBN-AS	479	E8132T-LBN-AS	407
E67888-LBC-WF	586	E67912-LBC-S	583	E8129I-LBN-FL	479	E8132T-LBN-FL	407
E67888-LBN-FL	586	E67912-LBN-FL	583	E8129I-LBN-S	479	E8132T-LBN-S	407
E67888-LBN-S	586	E67912-LBN-S	583	E8129-LBC-12	414	E8132T-LBN-WF	407
E67888-LBN-WF	586	E67913-LBC-FL	583	E8129-LBC-12-ST	421	E8140F-MLBC25	381
E67889-LBC-FL	586	E67913-LBC-S	583	E8129-LBC-55	414	E8140F-MLBC40	381
E67889-LBC-S	586	E67913-LBN-FL	583	E8129-LBC-55-ST	421	E8140F-MLBC-AS	381
E67889-LBC-WF	586	E67913-LBN-S	583	E8129-LBC-75	414	E8140F-MLBN25	381
E67889-LBN-FL	586	E7070-LBC	408	E8129-LBC-75-ST	421	E8140F-MLBN40	381
E67889-LBN-S	586	E7070-LBN	408	E8129-LBC-AE	414	E8140F-MLBN-AS	381
E67889-LBN-WF	586	E7120C-LBC15	392	E8129-LBC-AE-ST	421	E8140F-RGB-10	381
E67895-LBC-FL	587	E7120C-LBC24	392	E8129-LBC-AS	407	E8140F-RGB-30	381

COD.	PAG.	COD.	PAG.	COD.	PAG.	COD.	PAG.
E8140F-RGB-45	381	E8253C-LBC-15	625	E8272-LBN-ASI	412	E8340LBC-SDA	410
E8140-MLBC-25	469	E8253C-LBC-24	625	E8272-LBN-ASI-ST	419	E8340-LBC-WF	410
E8140-MLBC-40	469	E8253C-LBC-40	625	E8272-LBN-FL	399	E8340-LBC-WFD	410
E8140-MLBN-25	469	E8253C-LBN-15	625	E8272-LBN-S	399	E8340LBC-WFDA	410
E8140-MLBN-40	469	E8253C-LBN-24	625	E8272-LBN-WF	399	E8340-LBN-12	416
E8140-RGB-10	468	E8253C-LBN-40	625	E8276-LBC-AS	397	E8340-LBN-55	416
E8140-RGB-30	468	E8253-RGB	625	E8276-LBC-FL	397	E8340-LBN-75	416
E8140-RGB-45	468	E8254-RGB	627	E8276-LBC-S	397	E8340-LBN-AE	416
E8141-MLBC-25	469	E8261	625	E8276-LBC-WF	397	E8340-LBN-ASI	416
E8141-MLBC-40	469	E8262	627	E8276-LBN-AS	397	E8340-LBN-FL	410
E8141-MLBN-25	469	E8263-LBC-12	627	E8276-LBN-FL	397	E8340-LBN-FLD	410
E8141-MLBN-40	469	E8263-LBC-55	627	E8276-LBN-S	397	E8340LBN-FLDA	410
E8141-RGB-10	468	E8263-LBN-12	627	E8276-LBN-WF	397	E8340-LBN-S	410
E8141-RGB-30	468	E8263-LBN-55	627	E8276T-LBC-AS	395	E8340-LBN-SD	410
E8141-RGB-45	468	E8267TVLBC-24	427	E8276T-LBC-FL	395	E8340LBN-SDA	410
E8142-MLBC-25	469	E8267TVLBC-40	427	E8276T-LBC-S	395	E8340-LBN-WF	410
E8142-MLBC-40	469	E8267TVLBN-24	427	E8276T-LBC-WF	395	E8340-LBN-WFD	410
E8142-MLBN-25	469	E8267TVLBN-40	427	E8276T-LBN-AS	395	E8340LBN-WFDA	410
E8142-MLBN-40	469	E8271I-LBC-AS	475	E8276T-LBN-FL	395	E8345F-LBC-12	417
E8142-RGB-10	468	E8271I-LBC-FL	475	E8276T-LBN-S	395	E8345F-LBC-55	417
E8142-RGB-30	468	E8271I-LBC-S	475	E8276T-LBN-WF	395	E8345F-LBC-75	417
E8142-RGB-45	468	E8271I-LBC-WF	475	E8277F-LBC-12	413	E8345F-LBC-AE	417
E8184C-LBC-15	389	E8271I-LBN-AS	475	E8277F-LBC-55	413	E8345F-LBC-AS	417
E8184C-LBC15P	489	E8271I-LBN-FL	475	E8277F-LBC-75	413	E8345F-LBN-12	417
E8184C-LBC-24	389	E8271I-LBN-S	475	E8277F-LBC-AE	413	E8345F-LBN-55	417
E8184C-LBC24P	489	E8271I-LBN-WF	475	E8277F-LBC-ASI	413	E8345F-LBN-75	417
E8184C-LBC-40	389	E8271-LBC-AS	394	E8277F-LBN-12	413	E8345F-LBN-AE	417
E8184C-LBC40P	489	E8271-LBC-FL	394	E8277F-LBN-55	413	E8345F-LBN-ASI	417
E8184C-LBN-15	389	E8271-LBC-S	394	E8277F-LBN-75	413	E8345-LBC-FL	411
E8184C-LBN15P	489	E8271-LBC-WF	394	E8277F-LBN-AE	413	E8345-LBC-FLD	411
E8184C-LBN-24	389	E8271-LBN-AS	394	E8277F-LBN-ASI	413	E8345LBC-FLDA	411
E8184C-LBN24P	489	E8271-LBN-FL	394	E8277-LBC-AS	401	E8345-LBC-S	411
E8184C-LBN-40	389	E8271-LBN-S	394	E8277-LBC-FL	401	E8345-LBC-SD	411
E8184C-LBN40P	489	E8271-LBN-WF	394	E8277-LBC-S	401	E8345LBC-SDA	411
E8185CI-LBC15	473	E8272F-LBC-12	412	E8277-LBC-WF	401	E8345-LBC-WF	411
E8185CI-LBC24	473	E8272F-LBC-55	412	E8277-LBN-AS	401	E8345-LBC-WFD	411
E8185CI-LBC40	473	E8272F-LBC-75	412	E8277-LBN-FL	401	E8345LBC-WFDA	411
E8185CI-LBN15	473	E8272F-LBC-AE	412	E8277-LBN-S	401	E8345-LBN-FL	411
E8185CI-LBN24	473	E8272F-LBC-ASI	412	E8277-LBN-WF	401	E8345-LBN-FLD	411
E8185CI-LBN40	473	E8272F-LBN-12	412	E8277T-LBC-AS	400	E8345LBN-FLDA	411
E8185-I-RGB10	473	E8272F-LBN-55	412	E8277T-LBC-FL	400	E8345-LBN-S	411
E8185-I-RGB30	473	E8272F-LBN-75	412	E8277T-LBC-S	400	E8345-LBN-SD	411
E8185-I-RGB45	473	E8272F-LBN-AE	412	E8277T-LBC-WF	400	E8345LBN-SDA	411
E8202-LBC	445	E8272F-LBN-ASI	412	E8277T-LBN-AS	400	E8345-LBN-WF	411
E8202-LBI	445	E8272-LBC-12	412	E8277T-LBN-FL	400	E8345-LBN-WFD	411
E8202-LBN	445	E8272-LBC-12-ST	419	E8277T-LBN-S	400	E8345LBN-WFDA	411
E8203-LBC	445	E8272-LBC-55	412	E8277T-LBN-WF	400	E8346-LBC-FL	410
E8203-LBI	445	E8272-LBC-55-ST	419	E8340F-LBC-12	416	E8346-LBC-FLD	410
E8203-LBN	445	E8272-LBC-75	412	E8340F-LBC-55	416	E8346LBC-FLDA	410
E8239-LBC-12	621	E8272-LBC-75-ST	419	E8340F-LBC-75	416	E8346-LBC-S	410
E8239-LBC-55	621	E8272-LBC-AE	412	E8340F-LBC-AE	416	E8346-LBC-SD	410
E8239-LBN-12	621	E8272-LBC-AE-ST	419	E8340F-LBC-ASI	416	E8346LBC-SDA	410
E8239-LBN-55	621	E8272-LBC-AS	399	E8340F-LBN-12	416	E8346-LBC-WF	410
E8242-RGB	621	E8272-LBC-ASI	412	E8340F-LBN-55	416	E8346-LBC-WFD	410
E8246C-LBC-15	620	E8272-LBC-ASI-ST	419	E8340F-LBN-75	416	E8346LBC-WFDA	410
E8246C-LBC-24	620	E8272-LBC-FL	399	E8340F-LBN-AE	416	E8346-LBN-FL	410
E8246C-LBC-40	620	E8272-LBC-S	399	E8340F-LBN-ASI	416	E8346-LBN-FLD	410
E8246C-LBN-15	620	E8272-LBC-WF	399	E8340-LBC-12	416	E8346LBN-FLDA	410
E8246C-LBN-24	620	E8272-LBN-12	412	E8340-LBC-55	416	E8346-LBN-S	410
E8246C-LBN-40	620	E8272-LBN-12-ST	419	E8340-LBC-75	416	E8346-LBN-SD	410
E8246-RGB	620	E8272-LBN-55	412	E8340-LBC-AE	416	E8346LBN-SDA	410
E8249-LBC	623	E8272-LBN-55-ST	419	E8340-LBC-ASI	416	E8346-LBN-WF	410
E8249-LBI	623	E8272-LBN-75	412	E8340-LBC-FL	410	E8346-LBN-WFD	410
E8249-RGB	623	E8272-LBN-75-ST	419	E8340-LBC-FLD	410	E8346LBN-WFDA	410
E8251-RGB	394	E8272-LBN-AE	412	E8340LBC-FLDA	410	E8384C-LBC-15	393
E8251-T-RGB	395	E8272-LBN-AE-ST	419	E8340-LBC-S	410	E8384C-LBC-24	393
E8252-RGB	397	E8272-LBN-AS	399	E8340-LBC-SD	410	E8384C-LBC-40	393

COD.	PAG.	COD.	PAG.	COD.	PAG.	COD.	PAG.
E8384C-LBN-15	393	E8468-LBC	637	E871-MQ-LBN-C	485	E885-M-Q-LBC	459
E8384C-LBN-24	393	E8468-LBI	637	E8755	630	E885-M-Q-LBI	459
E8384C-LBN-40	393	E8468-LBN	637	E8756	630	E885-M-Q-LBL	459
E8384CT-LBC15	391	E8469-LBC	637	E8757	630	E885-M-Q-RGB	459
E8384CT-LBC24	391	E8469-LBI	637	E8758	631	E885-M-RGB	459
E8384CT-LBC40	391	E8469-LBN	637	E8759	631	E886-G-LBC	459
E8384CT-LBN15	391	E8470-LBC	637	E875-LBC	439	E886-G-LBC-C	461
E8384CT-LBN24	391	E8470-LBI	637	E875-LBI	439	E886-G-LBI	459
E8384CT-LBN40	391	E8470-LBN	637	E875-LBN	439	E886-G-LBL	459
E8384CTV-BC15	425	E8471-LBC	637	E8760	631	E886-G-LBN-C	461
E8384CTV-BC24	425	E8471-LBI	637	E876-LBC	439	E886-G-Q-LBC	459
E8384CTV-BC40	425	E8471-LBN	637	E876-LBI	439	E886-GQ-LBC-C	461
E8384CTV-BN15	425	E8494-LBC-I	471	E876-LBN	439	E886-G-Q-LBI	459
E8384CTV-BN24	425	E8494-LBC-Q-I	471	E877-LBC	439	E886-G-Q-LBL	459
E8384CTV-BN40	425	E8494-LBC-SM	383	E877-LBI	439	E886-GQ-LBN-C	461
E8392-LBI	440	E8494-LBC-SM	385	E877-LBN	439	E886-G-Q-RGB	459
E8392-LBL	440	E8494-LBC-SMQ	387	E878-LBC	439	E886-G-RGB	459
E8394-RGB	385	E8494-LBN-I	471	E878-LBI	439	E886-M-LBC	459
E8394-RGB-SM	383	E8494-LBN-Q-I	471	E878-LBN	439	E886-M-LBC-C	461
E8394-RGB-SMQ	387	E8494-LBN-SM	383	E8800-LBC	537	E886-M-LBI	459
E8394-VD-LBC	440	E8494-LBN-SM	385	E8800-LBN	537	E886-M-LBL	459
E8394-VD-LBL	440	E8494-LBN-SMQ	387	E8801-LBC	537	E886-M-LBN-C	461
E8394-VD-LBN	440	E8495-LBC	385	E8801-LBN	537	E886-M-Q-LBC	459
E8394-VD-LRO	440	E8495-LBC-SM	383	E8802-LBC	537	E886-MQ-LBC-C	461
E8394-VD-RGB	440	E8495-LBC-SMQ	387	E8802-LBN	537	E886-M-Q-LBI	459
E8395-LBC	385	E8495-LBN	385	E8805-LBC	537	E886-M-Q-LBL	459
E8395-LBC-SM	383	E8495-LBN-SM	383	E8805-LBN	537	E886-MQ-LBN-C	461
E8395-LBC-SMQ	387	E8495-LBN-SMQ	387	E8806-LBC	537	E886-M-Q-RGB	459
E8395-LBN	385	E8500-LBC	533	E8806-LBN	537	E886-M-RGB	459
E8395-LBN-SM	383	E8500-LBN	533	E8807-LBC	537	E8900-LBC	433
E8395-LBN-SMQ	387	E8501-LBC	533	E8807-LBN	537	E8900-LBN	433
E8396-LBC	443	E8501-LBN	533	E880-LBC	487	E8900-P-LBC	567
E8396-LBI	443	E8540-LBC	527	E880-LBL	487	E8900-P-LBN	567
E8396-LBL	443	E8540-LBC-EM	527	E880-LBN	487	E8900-PS-LBC	565
E8396-LBN	443	E8540-LBI	527	E881-G-LBC-68	457	E8900-PS-LBN	565
E8397-LBC	443	E8540-LBI-EM	527	E881-G-LBN-68	457	E8905-LBC	433
E8397-LBI	443	E8540-LBN	527	E881-GQ-LBC68	457	E8905-LBN	433
E8397-LBL	443	E8540-LBN-EM	527	E881-GQ-LBN68	457	E8910-LBC	433
E8397-LBN	443	E8541-LBC	527	E881-M-LBC-68	457	E8910-LBN	433
E8398-LBC	443	E8541-LBC-EM	527	E881-M-LBN-68	457	E8910-P-LBC	567
E8398-LBI	443	E8541-LBI	527	E881-MQ-LBC68	457	E8910-P-LBN	567
E8398-LBL	443	E8541-LBI-EM	527	E881-MQ-LBN68	457	E8910-PS-LBC	565
E8398-LBN	443	E8541-LBN	527	E8820-LBC	525	E8910-PS-LBN	565
E8399-1-LBC	441	E8541-LBN-EM	527	E8820-LBN	525	E8915-LBC	433
E8399-1-LBL	441	E8542-LBC	527	E8821-LBC	525	E8915-LBN	433
E8399-1-LBN	441	E8542-LBC-EM	527	E8821-LBN	525	E8920-LBC	433
E8399-LBC	441	E8542-LBI	527	E8822-LBC	525	E8920-LBN	433
E8399-LBL	441	E8542-LBI-EM	527	E8822-LBN	525	E8920-P-LBC	567
E8399-LBN	441	E8542-LBN	527	E8830-LBC	525	E8920-P-LBN	567
E8404-LBC	639	E8542-LBN-EM	527	E8830-LBN	525	E8920-PS-LBC	565
E8404-LBI	639	E8600-LBC	539	E8831-LBC	525	E8920-PS-LBN	565
E8404-LBN	639	E8600-LBN	539	E8831-LBN	525	E8925-LBC	433
E8405-LBC	639	E8601-LBC	539	E8832-LBC	525	E8925-LBN	433
E8405-LBI	639	E8601-LBN	539	E8832-LBN	525	E8930-LBC	433
E8405-LBN	639	E8602-LBC	539	E883-N-LBC-C	379	E8930-LBN	433
E8406-LBC	639	E8602-LBN	539	E883-N-LBN-C	379	E8930-P-LBC	567
E8406-LBI	639	E8650-LBC	539	E885-G-LBC	459	E8930-P-LBN	567
E8406-LBN	639	E8650-LBN	539	E885-G-LBI	459	E8930-PS-LBC	565
E8407-LBC	639	E8651-LBC	539	E885-G-LBL	459	E8930-PS-LBN	565
E8407-LBI	639	E8651-LBN	539	E885-G-Q-LBC	459	E8935-LBC	433
E8407-LBN	639	E8652-LBC	539	E885-G-Q-LBI	459	E8935-LBN	433
E8408-LBC	639	E8652-LBN	539	E885-G-Q-LBL	459	E893-LBC	448
E8408-LBI	639	E871-M-LBC-C	463	E885-G-Q-RGB	459	E893-LBI	448
E8408-LBN	639	E871-M-LBN-C	463	E885-G-RGB	459	E893-LBL	448
E8409-LBC	639	E871-MQ-LBC-C	463	E885-M-LBC	459	E893-M-LBC	449
E8409-LBI	639	E871-MQ-LBC-C	485	E885-M-LBI	459	E893-M-LBI	449
E8409-LBN	639	E871-MQ-LBN-C	463	E885-M-LBL	459	E893-M-LBL	449

COD.	PAG.	COD.	PAG.	COD.	PAG.	COD.	PAG.
E893-M-Q-LBC	449	E8957AS-LBC24	437	E9031-LBN-35	573	E909BR-LBC	596
E893-M-Q-LBI	449	E8957AS-LBI24	437	E9031-LBN-EL	573	E909BR-LBC-V	596
E893-M-Q-LBL	449	E8957AS-LBN24	437	E9032-LBC-25	573	E909BR-LBI	596
E8941AS-LBC-6	437	E8957-LBC	431	E9032-LBC-35	573	E909BR-LBI-V	596
E8941AS-LBI-6	437	E8957-LBC-24	435	E9032-LBC-EL	573	E909BR-LBL	596
E8941AS-LBN-6	437	E8957-LBN	431	E9032-LBN-25	573	E909BR-LBL-V	596
E8941-LBC	431	E8957-LBN-24	435	E9032-LBN-35	573	E909BR-LBN	596
E8941-LBC-6	435	E8957-P-LBC	567	E9032-LBN-EL	573	E909BR-LBN-V	596
E8941-LBN	431	E8957-P-LBC24	569	E9033-LBC-25	573	E909BR-L-LBC	599
E8941-LBN-6	435	E8957-P-LBN	567	E9033-LBC-35	573	E909BR-L-LBI	599
E8941-P-LBC	567	E8957-P-LBN24	569	E9033-LBC-EL	573	E909BR-L-LBL	599
E8941-P-LBC-6	569	E8957-PS-LBC	565	E9033-LBN-25	573	E909BR-L-LBN	599
E8941-P-LBN	567	E8957PS-LBC24	568	E9033-LBN-35	573	E909BR-Q-LBC	597
E8941-P-LBN-6	569	E8957-PS-LBN	565	E9033-LBN-EL	573	E909BRQ-LBC-V	597
E8941-PS-LBC	565	E8957PS-LBN24	568	E9034-LBC-25	573	E909BR-Q-LBI	597
E8941-PS-LBC6	568	E8958AS-LBC30	437	E9034-LBC-35	573	E909BRQ-LBI-V	597
E8941-PS-LBN	565	E8958AS-LBI30	437	E9034-LBC-EL	573	E909BR-Q-LBL	597
E8941-PS-LBN6	568	E8958AS-LBN30	437	E9034-LBN-25	573	E909BRQ-LBL-V	597
E8942AS-LBC24	437	E8958AS-RGB30	437	E9034-LBN-35	573	E909BR-Q-LBN	597
E8942AS-LBI24	437	E8958-LBC	431	E9034-LBN-EL	573	E909BRQ-LBN-V	597
E8942AS-LBN24	437	E8958-LBC-30	435	E9035-LBC-25	573	E909-LBC	596
E8942-LBC	431	E8958-LBN	431	E9035-LBC-35	573	E909-LBC-V	596
E8942-LBC-24	435	E8958-LBN-30	435	E9035-LBC-EL	573	E909-LBI	596
E8942-LBN	431	E8958-LBN-30	435	E9035-LBN-25	573	E909-LBI-V	596
E8942-LBN-24	435	E8958-P-LBC	567	E9035-LBN-35	573	E909-LBL	596
E8943AS-LBC30	437	E8958-P-LBC30	569	E9035-LBN-EL	573	E909-LBI-V	596
E8943AS-LBI30	437	E8958-P-LBN	567	E9050-LBC	429	E909-LBN	596
E8943AS-LBN30	437	E8958-P-LBN30	569	E9050-LBN	429	E909-LBN-V	596
E8943AS-RGB30	437	E8958-PS-LBC	565	E9050-LBN	429	E909-L-LBC	599
E8943-LBC	431	E8958PS-LBC30	568	E9050-P-LBC	564	E909-L-LBI	599
E8943-LBC-30	435	E8958-PS-LBN	565	E9050-P-LBN	564	E909-L-LBL	599
E8943-LBN	431	E8958PS-LBN30	568	E9051-LBC	429	E909-L-LBN	599
E8943-LBN-30	435	E8958-RGB-30	435	E9051-LBN	429	E909NE-LBC	596
E8943-RGB-30	435	E897-G-LBC	455	E9051-P-LBC	564	E909NE-LBC-V	596
E8946AS-LBC-6	437	E897-G-LBN	455	E9051-P-LBN	564	E909NE-LBI	596
E8946AS-LBI-6	437	E897-M-LBC	455	E9051-P-RGB	564	E909NE-LBI-V	596
E8946AS-LBN-6	437	E897-M-LBN	455	E9051-RGB	429	E909NE-LBL	596
E8946-LBC	431	E898-LBC	448	E9052-LBC	429	E909NE-LBL-V	596
E8946-LBC-6	435	E898-LBI	448	E9052-LBN	429	E909NE-LBN	596
E8946-LBN	431	E898-LBL	448	E9052-P-LBC	564	E909NE-LBN-V	596
E8946-LBN-6	435	E898-M-LBC	449	E9052-P-LBN	564	E909NE-L-LBC	599
E894-G-LBC	455	E898-M-LBI	449	E9053-LBC	605	E909NE-L-LBI	599
E894-G-LBN	455	E898-M-LBL	449	E9053-LBI	605	E909NE-L-LBL	599
E894-M-LBC	455	E898-M-Q-LBC	449	E9053-LBL	605	E909NE-L-LBN	599
E894-M-LBN	455	E898-M-Q-LBI	449	E9053-P-LBC	607	E909NE-Q-LBC	597
E8951AS-LBC18	437	E898-M-Q-LBL	449	E9053-P-LBI	607	E909NEQ-LBC-V	597
E8951AS-LBI18	437	E900-G-LBC	451	E9053-P-LBL	607	E909NE-Q-LBI	597
E8951AS-LBN18	437	E900-G-LBI	451	E9054-LBC	429	E909NEQ-LBI-V	597
E8951-LBC	431	E900-G-LBN	451	E9054-LBN	429	E909NE-Q-LBL	597
E8951-LBC-18	435	E900-M-LBC	451	E9054-P-LBC	564	E909NEQ-LBL-V	597
E8951-LBN	431	E900-M-LBI	451	E9054-P-LBN	564	E909NE-Q-LBN	597
E8951-LBN-18	435	E900-M-LBN	451	E9060-LBC	429	E909NEQ-LBN-V	597
E8951-P-LBC	567	E901-M-LBC	483	E9060-LBN	429	E909-Q-LBC	597
E8951-P-LBC18	569	E901-M-LBN	483	E9060-P-LBC	564	E909-Q-LBC-V	597
E8951-P-LBN	567	E9020-LBN	571	E9060-P-LBN	564	E909-Q-LBI	597
E8951-P-LBN18	569	E9021-LBN	571	E9061-LBC	429	E909-Q-LBI-V	597
E8951-PS-LBC	565	E9022-LBN	571	E9061-LBN	429	E909-Q-LBL	597
E8951PS-LBC18	568	E9023-LBN	571	E9061-P-LBC	564	E909-Q-LBL-V	597
E8951-PS-LBN	565	E9030-LBC-25	573	E9061-P-LBN	564	E909-Q-LBN	597
E8951PS-LBN18	568	E9030-LBC-35	573	E9061-P-RGB	564	E909-Q-LBN-V	597
E8956AS-LBC18	437	E9030-LBC-EL	573	E9061-RGB	429	E912-LBC	499
E8956AS-LBI18	437	E9030-LBN-25	573	E9062-LBC	429	E912-LBL	499
E8956AS-LBN18	437	E9030-LBN-35	573	E9062-LBN	429	E912-LBN	499
E8956-LBC	431	E9030-LBN-EL	573	E9062-P-LBC	564	E919-LBC-25	581
E8956-LBC-18	435	E9031-LBC-25	573	E9062-P-LBN	564	E919-LBC-40	581
E8956-LBN	431	E9031-LBC-35	573	E908-LBC	491	E919-LBN-25	581
E8956-LBN-18	435	E9031-LBC-EL	573	E908-LBI	491	E919-LBN-40	581
		E9031-LBN-25	573	E908-LBN	491		

INDICE CODICE PRODOTTI · PRODUCTS CODES INDEX

COD.	PAG.	COD.	PAG.	COD.	PAG.	COD.	PAG.
E920-LBC	579	E951NE-L-LBN	599	J350-68-LED	656	KT1227-LBN-4	20
E920-LBL	579	E951NE-Q-LBC	597	J700-68-LED	656	KT1227Q-LBC12	23
E920-LBN	579	E951NEQ-LBC-V	597	KE8140FMLBC25	381	KT1227Q-LBC4	23
E921-LBC	581	E951NE-Q-LBI	597	KE8140FMLBC40	381	KT1227Q-LBN12	23
E921-LBI	581	E951NEQ-LBI-V	597	KE8140FMLBCAS	381	KT1228-LBC-4	21
E921-LBL	581	E951NE-Q-LBL	597	KE8140FMLBN25	381	KT1228-LBN-4	21
E922-RGB	577	E951NEQ-LBL-V	597	KE8140FMLBN40	381	KT1229-LBC-4	21
E924-RGB	577	E951NE-Q-LBN	597	KE8140FMLBNAS	381	KT1229-LBN-4	21
E926-RGB	577	E951NEQ-LBN-V	597	KT1220-LBC-12	20	KT12207-LBN4	23
E928-RGB	577	E951-Q-LBC	597	KT1220-LBC-4	20	KT1230-LBC-4	21
E930-RGB	577	E951-Q-LBC-V	597	KT1220-LBN-12	20	KT1230-LBN-4	21
E931-LBC	465	E951-Q-LBI	597	KT1220-LBN-4	20	KT1231-LBC-4	21
E931-LBI	465	E951-Q-LBI-V	597	KT1220Q-LBC12	23	KT1231-LBN-4	21
E931-LBL	465	E951-Q-LBL	597	KT1220Q-LBC4	23	KT2815-MLBC25	33
E933-LBC	465	E951-Q-LBL-V	597	KT1220Q-LBN12	23	KT2815-MLBC40	33
E933-LBI	465	E951-Q-LBN	597	KT1220Q-LBN4	23	KT2815-MLBN25	33
E933-LBL	465	E951-Q-LBN-V	597	KT1221-LBC-12	20	KT2815-MLBN40	33
E933-RGB	465	E953-LBC	577	KT1221-LBC-4	20	KT2816-MLBC25	33
E934-LBC	465	E953-LBI	577	KT1221-LBN-12	20	KT2816-MLBC40	33
E934-LBI	465	E953-LBN	577	KT1221-LBN-4	20	KT2816-MLBN25	33
E934-LBL	465	E954-LBC	577	KT1221Q-LBC12	23	KT2816-MLBN40	33
E935-LBC	465	E954-LBI	577	KT1221Q-LBC4	23	KT2817-MLBC25	33
E935-LBI	465	E954-LBN	577	KT1221Q-LBN12	23	KT2817-MLBC40	33
E935-LBL	465	E955-LBC	577	KT1221Q-LBN4	23	KT2817-MLBN25	33
E951BR-LBC	596	E955-LBI	577	KT1222-LBC-12	20	KT2817-MLBN40	33
E951BR-LBC-V	596	E955-LBN	577	KT1222-LBC-4	20	KT2818-MLBC25	33
E951BR-LBI	596	E956-LBC	577	KT1222-LBN-12	20	KT2818-MLBC40	33
E951BR-LBI-V	596	E956-LBI	577	KT1222-LBN-4	20	KT2818-MLBN25	33
E951BR-LBL	596	E956-LBN	577	KT1222Q-LBC12	23	KT2818-MLBN40	33
E951BR-LBL-V	596	E960	389	KT1222Q-LBC4	23	KT2825-JLBC25	35
E951BR-LBN	596	E9601-RGB-120	613	KT1222Q-LBN12	23	KT2825-JLBC40	35
E951BR-LBN-V	596	E9601-RGB-30	613	KT1222Q-LBN4	23	KT2825-JLBN25	35
E951BR-L-LBC	599	E9602-LBI-120	617	KT1223-LBC-12	20	KT2825-JLBN40	35
E951BR-L-LBI	599	E9602-LBI-15	617	KT1223-LBC-4	20	KT2825-MLBC25	33
E951BR-L-LBL	599	E9602-LBI-18	617	KT1223-LBN-12	20	KT2825-MLBC40	33
E951BR-L-LBN	599	E9602-LBI-80	617	KT1223-LBN-4	20	KT2825-MLBN25	33
E951BR-Q-LBC	597	E9603-LBI-120	614	KT1223Q-LBC12	23	KT2825-MLBN40	33
E951BRQ-LBC-V	597	E9603-LBI-21	614	KT1223Q-LBC4	23	KT2826-JLBC25	35
E951BR-Q-LBI	597	E9603-LBI-45	614	KT1223Q-LBN12	23	KT2826-JLBC40	35
E951BRQ-LBI-V	597	E9603-LBI-65	614	KT1223Q-LBN4	23	KT2826-JLBN25	35
E951BR-Q-LBL	597	E9604-LBI-120	610	KT1224-LBC-12	20	KT2826-JLBN40	35
E951BRQ-LBL-V	597	E9604-LBI-30	610	KT1224-LBC-4	20	KT2826-MLBC25	33
E951BR-Q-LBN	597	E9605-RGB-120	618	KT1224-LBN-12	20	KT2826-MLBC40	33
E951BRQ-LBN-V	597	E9605-RGB-15	618	KT1224-LBN-4	20	KT2826-MLBN25	33
E951-LBC	596	E9605-RGB-18	618	KT1224Q-LBC12	23	KT2826-MLBN40	33
E951-LBC-V	596	E9605-RGB-80	618	KT1224Q-LBC4	23	KT2827-MLBC25	33
E951-LBI	596	E9606-RGB-120	619	KT1224Q-LBN12	23	KT2827-MLBC40	33
E951-LBI-V	596	E9606-RGB-15	619	KT1224Q-LBN4	23	KT2827-MLBN25	33
E951-LBL	596	E9606-RGB-35	619	KT1225-LBC-12	20	KT2827-MLBN40	33
E951-LBL-V	596	E9606-RGB-80	619	KT1225-LBC-4	20	KT2828-MLBC25	33
E951-LBN	596	E9607-RGB-120	615	KT1225-LBN-12	20	KT2828-MLBC40	33
E951-LBN-V	596	E9607-RGB-15	615	KT1225-LBN-4	20	KT2828-MLBN25	33
E951-L-LBC	599	E9607-RGB-35	615	KT1225Q-LBC12	23	KT2828-MLBN40	33
E951-L-LBI	599	E9607-RGB-80	615	KT1225Q-LBC4	23	KT2860-LBC	103
E951-L-LBL	599	E9608-RGB-120	611	KT1225Q-LBN12	23	KT2860-LBN	103
E951-L-LBN	599	E9608-RGB-30	611	KT1225Q-LBN4	23	KT2861-LBC	103
E951NE-LBC	596	E961-LBC	575	KT1226-LBC-12	20	KT2861-LBN	103
E951NE-LBC-V	596	E961-LBI	575	KT1226-LBC-4	20	KT2862-LBC	103
E951NE-LBI	596	E961-LBN	575	KT1226-LBN-12	20	KT2862-LBN	103
E951NE-LBI-V	596	E962-LBC	575	KT1226-LBN-4	20	KT2865-LBC	85
E951NE-LBL	596	E962-LBI	575	KT1226Q-LBC12	23	KT2865-LBN	85
E951NE-LBL-V	596	E962-LBN	575	KT1226Q-LBC4	23	KT2866-LBC	85
E951NE-LBN	596	E963-LBC	575	KT1226Q-LBN12	23	KT2866-LBN	85
E951NE-LBN-V	596	E963-LBI	575	KT1226Q-LBN4	23	KT2868-LBC	102
E951NE-L-LBC	599	E963-LBN	575	KT1227-LBC-12	20	KT2868-LBN	102
E951NE-L-LBI	599	INV 1052	55	KT1227-LBC-4	20	KT2869-LBC	102
E951NE-L-LBL	599	INV 1052-3	55	KT1227-LBN-12	20	KT2869-LBN	102

COD.	PAG.	COD.	PAG.	COD.	PAG.	COD.	PAG.
KT2870-LBC	102	KT5806LBC75	79	KT5841LBNAS	81	KT5881LBN75	101
KT2870-LBN	102	KT5806LBCAE	79	KT5841LBNBAS	81	KT5881LBNAE	101
KT2875-LBC	105	KT5806LBCAS	79	KT5845LBC12	83	KT5881LBNAS	101
KT2875-LBN	105	KT5806LBCBAS	79	KT5845LBC75	83	KT-E1219LBC-2	467
KT2876-LBC	105	KT5806LBN12	79	KT5845LBCAE	83	KT-E1219LBC-4	467
KT2876-LBN	105	KT5806LBN75	79	KT5845LBCAS	83	KT-E1219LBC-8	467
KT2877-LBC	105	KT5806LBNAE	79	KT5845LBCBAS	83	KT-E1219LBN-2	467
KT2877-LBN	105	KT5806LBNAS	79	KT5845LBN12	83	KT-E1219LBN-4	467
KT2880-LBC-DA	47	KT5806LBNBAS	79	KT5845LBN75	83	KT-E1219LBN-8	467
KT2880-LBC-OF	47	KT5820LBC12	80	KT5845LBNAE	83	KT-E1220LBC-2	467
KT2880-LBC-PH	47	KT5820LBC75	80	KT5845LBNAS	83	KT-E1220LBC-4	467
KT2880-LBN-DA	47	KT5820LBCAE	80	KT5845LBNBAS	83	KT-E1220LBC-8	467
KT2880-LBN-OF	47	KT5820LBCAS	80	KT5846LBC12	83	KT-E1220LBN-2	467
KT2880-LBN-PH	47	KT5820LBCBAS	80	KT5846LBC75	83	KT-E1220LBN-4	467
KT2881-LBC-DA	47	KT5820LBN12	80	KT5846LBCAE	83	KT-E1220LBN-8	467
KT2881-LBC-OF	47	KT5820LBN75	80	KT5846LBCAS	83	KT-E1221LBC-2	467
KT2881-LBC-PH	47	KT5820LBNAE	80	KT5846LBCBAS	83	KT-E1221LBC-4	467
KT2881-LBN-DA	47	KT5820LBNAS	80	KT5846LBN12	83	KT-E1221LBC-8	467
KT2881-LBN-OF	47	KT5820LBNBAS	80	KT5846LBN75	83	KT-E1221LBN-2	467
KT2881-LBN-PH	47	KT5821LBC12	80	KT5846LBNAE	83	KT-E1221LBN-4	467
KT2885-LBC-DA	49	KT5821LBC75	80	KT5846LBNAS	83	KT-E1221LBN-8	467
KT2885-LBC-OF	49	KT5821LBCAE	80	KT5846LBNBAS	83	KT-E1222LBC-2	467
KT2885-LBN-DA	49	KT5821LBCAS	80	KT5850LBC12	83	KT-E1222LBC-4	467
KT2885-LBN-OF	49	KT5821LBCBAS	80	KT5850LBC75	83	KT-E1222LBC-8	467
KT2886-LBC-DA	49	KT5821LBN12	80	KT5850LBCAE	83	KT-E1222LBN-2	467
KT2886-LBC-OF	49	KT5821LBN75	80	KT5850LBCAS	83	KT-E1222LBN-4	467
KT2886-LBN-DA	49	KT5821LBNAE	80	KT5850LBCBAS	83	KT-E1222LBN-8	467
KT2886-LBN-OF	49	KT5821LBNAS	80	KT5850LBN12	83	KT-E1223LBC-2	467
KT2887-LBC-DA	49	KT5821LBNBAS	80	KT5850LBN75	83	KT-E1223LBC-4	467
KT2887-LBC-OF	49	KT5825LBC12	80	KT5850LBNAE	83	KT-E1223LBC-8	467
KT2887-LBN-DA	49	KT5825LBC75	80	KT5850LBNAS	83	KT-E1223LBN-2	467
KT2887-LBN-OF	49	KT5825LBCAE	80	KT5850LBNBAS	83	KT-E1223LBN-4	467
KT2890-LBC-DA	51	KT5825LBCAS	80	KT5851LBC12	83	KT-E1223LBN-8	467
KT2890-LBC-OF	51	KT5825LBCBAS	80	KT5851LBC75	83	KT-E1224LBC-2	467
KT2890-LBN-DA	51	KT5825LBN12	80	KT5851LBCAE	83	KT-E1224LBC-4	467
KT2890-LBN-OF	51	KT5825LBN75	80	KT5851LBCAS	83	KT-E1224LBC-8	467
KT5800LBC12	79	KT5825LBNAE	80	KT5851LBCBAS	83	KT-E1224LBN-2	467
KT5800LBC75	79	KT5825LBNAS	80	KT5851LBN12	83	KT-E1224LBN-4	467
KT5800LBCAE	79	KT5825LBNBAS	80	KT5851LBN75	83	KT-E1224LBN-8	467
KT5800LBCAS	79	KT5826LBC12	80	KT5851LBNAE	83	KTE8140MLBC25	469
KT5800LBCBAS	79	KT5826LBC75	80	KT5851LBNAS	83	KTE8140MLBC40	469
KT5800LBN12	79	KT5826LBCAE	80	KT5851LBNBAS	83	KTE8140MLBN25	469
KT5800LBN75	79	KT5826LBCAS	80	KT5870LBC12	100	KTE8140MLBN40	469
KT5800LBNAE	79	KT5826LBCBAS	80	KT5870LBC75	100	KTE8141MLBC25	469
KT5800LBNAS	79	KT5826LBN12	80	KT5870LBCAE	100	KTE8141MLBC40	469
KT5800LBNBAS	79	KT5826LBN75	80	KT5870LBCAE	100	KTE8141MLBN25	469
KT5801LBC12	79	KT5826LBNAE	80	KT5870LBN12	100	KTE8141MLBN40	469
KT5801LBC75	79	KT5826LBNAS	80	KT5870LNC75	100	KTE8142MLBC25	469
KT5801LBCAE	79	KT5826LBNBAS	80	KT5871LBC12	100	KTE8142MLBC40	469
KT5801LBCAS	79	KT5840LBC12	81	KT5871LBC75	100	KTE8142MLBN25	469
KT5801LBCBAS	79	KT5840LBC75	81	KT5871LBCAE	100	KTE8142MLBN40	469
KT5801LBN12	79	KT5840LBCAE	81	KT5871LBCAE	100	KTE8494-LBC-1	471
KT5801LBN75	79	KT5840LBCAS	81	KT5871LBN12	100	KTE8494LBC-QI	471
KT5801LBNAE	79	KT5840LBCBAS	81	KT5871LBN75	100	KTE8494-LBN-1	471
KT5801LBNAS	79	KT5840LBN12	81	KT5880LBC12	101	KTE8494LBN-QI	471
KT5801LBNBAS	79	KT5840LBN75	81	KT5880LBC75	101	KTE875-LBC	439
KT5805LBC12	79	KT5840LBNAE	81	KT5880LBCAE	101	KTE875-LBI	439
KT5805LBC75	79	KT5840LBNAS	81	KT5880LBCAS	101	KTE875-LBN	439
KT5805LBCAE	79	KT5840LBNBAS	81	KT5880LBN12	101	KTE876-LBC	439
KT5805LBCAS	79	KT5841LBC12	81	KT5880LBN75	101	KTE876-LBI	439
KT5805LBCBAS	79	KT5841LBC75	81	KT5880LBNAE	101	KTE876-LBN	439
KT5805LBN12	79	KT5841LBCAE	81	KT5880LBNAS	101	KTE877-LBC	439
KT5805LBN75	79	KT5841LBCAS	81	KT5881LBC12	101	KTE877-LBI	439
KT5805LBNAE	79	KT5841LBCBAS	81	KT5881LBC75	101	KTE877-LBN	439
KT5805LBNAS	79	KT5841LBN12	81	KT5881LBCAE	101	KTE878-LBC	439
KT5805LBNBAS	79	KT5841LBN75	81	KT5881LBCAS	101	KTE878-LBI	439
KT5806LBC12	79	KT5841LBNAE	81	KT5881LBN12	101	KTE878-LBN	439

COD.	PAG.	COD.	PAG.	COD.	PAG.	COD.	PAG.
KT-E880-LBC-3	487	M-25201	170	P40-P-BW	500		
KT-E880-LBC-6	487	M-25201H	170	P40-P-GA	500		
KT-E880-LBL-3	487	M-25202	170	P40-P-NE	500		
KT-E880-LBL-6	487	M-25202H	170	P410-P	653		
KT-E880-LBN-3	487	M-25301	170	P411-P	653		
KT-E880-LBN-6	487	M-25301H	170	P412-P	653		
KTE883N-LBC-C	379	M-25302	170	QDR27-LBC	265		
KTE883N-LBN-C	379	M-25302H	170	QDR27-LBN	265		
KTE885-G-LBC	459	M-26102	171	QDR27-P-LBC	265		
KTE885-G-LBI	459	M-26202	171	QDR27-P-LBN	265		
KTE885-G-LBL	459	M-26302	171	QDR40-LBC	265		
KTE885-M-LBC	459	M-6001-LBC	174	QDR40-LBN	265		
KTE885-M-LBI	459	M-6001-LBN	174	QDR40-P-LBC	265		
KTE885-M-LBL	459	M-6002-LBC	175	QDR40-P-LBN	265		
KTE886-G-LBC	459	M-6002-LBN	175	QDR60-LBC	265		
KTE886G-LBC-C	461	M-6003-LBC	174	QDR60-LBC-P	265		
KTE886-G-LBI	459	M-6003-LBN	174	QDR60-LBI	265		
KTE886-G-LBL	459	M-6004-LBC	175	QDR60-LBI-P	265		
KTE886G-LBN-C	461	M-6004-LBN	175	RL4200-LBC	111		
KTE886GQ-LBC-C	461	M-6005-LBC	174	RL4200-LBI	111		
KTE886GQ-LBN-C	461	M-6005-LBN	174	RL4200-LBN	111		
KTE886-M-LBC	459	M-6006-LBC	175	RL4201-LBC	111		
KTE886-MLBC-C	461	M-6006-LBN	175	RL4201-LBI	111		
KTE886-M-LBI	459	M-6007-LBC	174	RL4201-LBN	111		
KTE886-M-LBL	459	M-6007-LBN	174	SL940-LBC	283		
KTE886-MLBN-C	461	M-67383-LBC20	176	SL940-LBI	283		
KTE886MLBC-C	461	M-67383-LBN20	176	SL940-LBN	283		
KTE886MLBN-C	461	M-67384-LBC20	176	SL941-LBC	283		
KTE893-M-LBC	449	M-67384-LBN20	176	SL941-LBI	283		
KTE893-M-LBI	449	M-67386-LBC20	176	SL941-LBN	283		
KTE893-M-LBL	449	M-67386-LBN20	176	SL942-LBC	283		
KTE893M-Q-LBC	449	M-67387-LBC20	176	SL942-LBI	283		
KTE893M-Q-LBI	449	M-67387-LBN20	176	SL942-LBN	283		
KTE893M-Q-LBL	449	M-99040	173	SL943-LBC	283		
KTE894-G-LBC	455	M-99041	173	SL943-LBI	283		
KTE894-G-LBN	455	M-99044	173	SL943-LBN	283		
KTE894-M-LBC	455	M-99045	173	SL944-LBC	283		
KTE894-M-LBN	455	M-99046	173	SL944-LBI	283		
KTE895-G-LBC	453	M-99047	173	SL944-LBN	283		
KTE895-G-LBI	453	M-99048	173				
KTE895-G-LBL	453	M-99049	173				
KTE895-M-LBC	453	M-99050	173				
KTE895M-LBCAS	453	M-99051	170				
KTE895-M-LBI	453	M-99052	170				
KTE895M-LBIAS	453	M-99052	171				
KTE895-M-LBL	453	M-99053	170				
KTE895M-LBLAS	453	M-99054	170				
KTE896-G-LBC	453	M-99055	170				
KTE896-G-LBI	453	M-99056	170				
KTE896-G-LBL	453	M-99057	170				
KTE896-M-LBC	453	M-99058	170				
KTE896-M-LBI	453	M-99059	170				
KTE896-M-LBL	453	M-99060	170				
KTE897-G-LBC	455	M-99061	170				
KTE897-G-LBN	455	M-99062	170				
KTE897-M-LBC	455	M-99063	170				
KTE897-M-LBN	455	M-99064	170				
KTE898-M-LBC	449	M-99075	171				
KTE898-M-LBI	449	M-99076	171				
KTE898-M-LBL	449	M-99077	171				
KTE898M-Q-LBC	449	M-D2210-LBC-S	177				
KTE898M-Q-LBI	449	M-D2210-LBN-S	177				
KTE898M-Q-LBL	449	M-D2211-LBC-S	177				
M-25101	170	M-D2211-LBN-S	177				
M-25101H	170	P40-BW	500				
M-25102	170	P40-GA	500				
M-25102H	170	P40-NE	500				



SIDE spa

Via C. Cattaneo 90
20851 Lissone (MB)

Tel. +39 039 2449001
Fax +39 039 2459338

info@sidespa.it
www.sidespa.it

Printed in Italy 01.2022
© 2022, Side S.p.A.

Tutti i diritti riservati.
Nessuna parte del presente
catalogo può essere riprodotta
o diffusa con un mezzo qualsiasi,
fotocopie, microfilm o altro, senza
il permesso del titolare del copyright.

All rights reserved.
No part of this catalogue
can be reproduced or spread
by any means, photocopying,
microfilm or others, without the
copyright holder's permission.

