

 PLAYLED



FUTURA

Luce che disegna lo spazio urbano

FUTURA

Luce che disegna lo spazio urbano



M A D E I N I T A L Y



Qualità e affidabilità made in Playled, anche nell'arredo urbano

La gamma **FUTURA** è progettata per garantire **massima resistenza e affidabilità nel tempo**, grazie a un corpo in alluminio pressofuso verniciato a polvere e a uno schermo in vetro temperato. Questi materiali assicurano una protezione efficace contro le intemperie e l'usura, rendendo **FUTURA** la scelta ideale per l'illuminazione di spazi pubblici e privati.



Corpo resistente in **alluminio pressofuso verniciato a polvere** e **vetro temperato** ad alto spessore. Ideale anche in ambienti aggressivi come quelli marini.

Efficienza energetica e tecnologia avanzata



Dotato di diodi ad alta efficienza, **FUTURA** garantisce un'illuminazione ottimale con un basso consumo energetico. Il sistema è progettato per combinare la massima efficienza luminosa con una lunga durata operativa, **riducendo al minimo la necessità di manutenzione.**



SMART CITY READY

Dall'apparecchio alla città intelligente: l'evoluzione della luce con Futura

FUTURA rende la luce modulabile per rispondere alle esigenze urbane. Si parte dal semplice controllo on/off fino alla gestione avanzata con **DALI**, che permette un controllo puntuale e l'integrazione nei sistemi **Smart Lighting**. Grazie all'**attacco Zhaga**, **FUTURA** trasforma i punti luce in nodi digitali attivi, ottimizzando la gestione e i consumi, **rendendo le città più intelligenti e sostenibili**.



Versatilità delle applicazioni

La **gamma** offre soluzioni per diverse esigenze di illuminazione urbana:

PR a parete

TP testa palo

TS tesata



Ad ogni installazione le sue possibilità di emissione:

TP

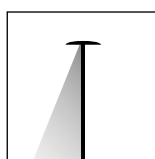

monoemissione

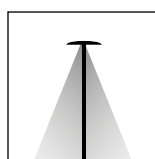

biemissione

PR

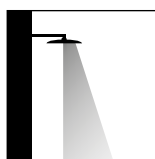

monoemissione

TS

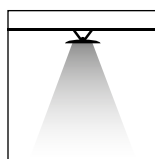

biemissione

Custom

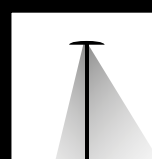

biemissione con
ottiche diverse

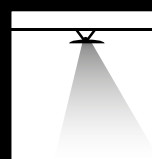

biemissione con
ottiche diverse

PR



TS

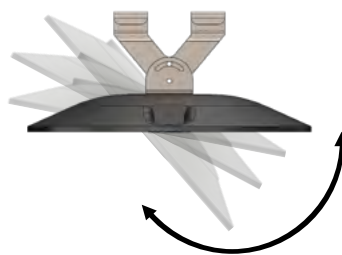
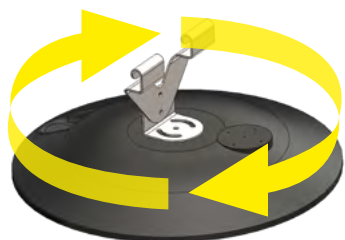

TP





Una grande combinazione di ottiche

SIMMETRICHE

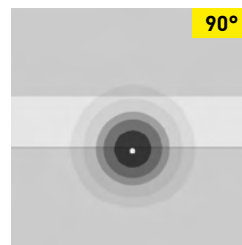
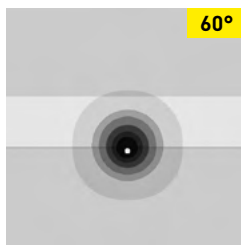
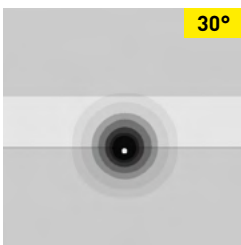

ASIMMETRICHE

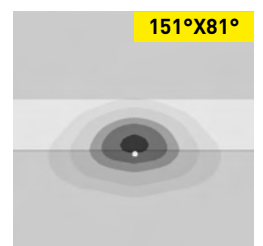
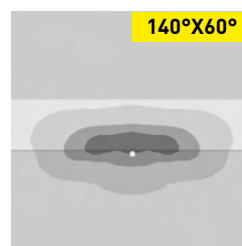
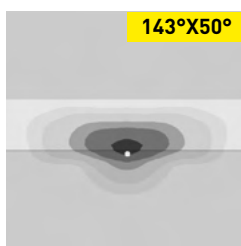
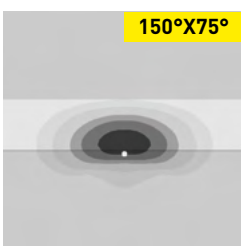

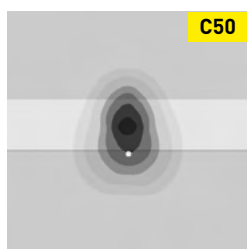
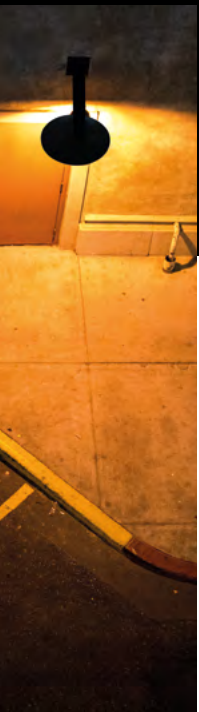

FUTURA TP

B I E M I S S I O N E

FASCI DI LUCE

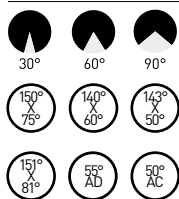

CONSUMO

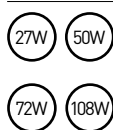

ALIMENTAZIONE



APPLICAZIONE

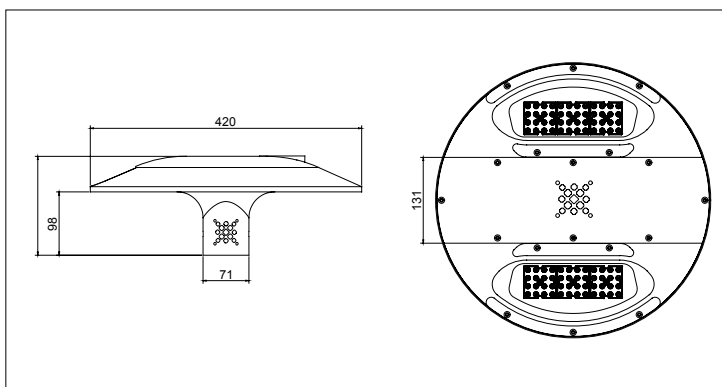

FUTURA TP27

CODICE	TEMP.COL	ANG.	NOMIN	LUMEN USCENTI TE°=25	DESCRIZIONE METEL	LISTINO IVA ESCLUSA
SIMMETRICI						
FUTP2730AM	2200 K	30°	3996 LM	3118 LM	FUTURA T.PALO 27W 30° IP66 230V 2200K	379,00 €
FUTP2760AM	2200 K	60°	3996 LM	3074 LM	FUTURA T.PALO 27W 60° IP66 230V 2200K	379,00 €
FUTP2790AM	2200 K	90°	3996 LM	3052 LM	FUTURA T.PALO 27W 90° IP66 230V 2200K	379,00 €
FUTP2730C	3000 K	30°	4401 LM	3668 LM	FUTURA T.PALO 27W 30° IP66 230V 3000K	379,00 €
FUTP2760C	3000 K	60°	4401 LM	3617 LM	FUTURA T.PALO 27W 60° IP66 230V 3000K	379,00 €
FUTP2790C	3000 K	90°	4401 LM	3591 LM	FUTURA T.PALO 27W 90° IP66 230V 3000K	379,00 €
FUTP2730N	4000 K	30°	4644 LM	3861 LM	FUTURA T.PALO 27W 30° IP66 230V 4000K	379,00 €
FUTP2760N	4000 K	60°	4644 LM	3807 LM	FUTURA T.PALO 27W 60° IP66 230V 4000K	379,00 €
FUTP2790N	4000 K	90°	4644 LM	3780 LM	FUTURA T.PALO 27W 90° IP66 230V 4000K	379,00 €
ASIMMETRICI						
FUTP27TCOAM	2200 K	150°X75°	3996 LM	2965 LM	FUTURA T.PALO 27W 150X75° IP66 230V 2200K	379,00 €
FUTP27T1SAM	2200 K	143°X50°	3996 LM	2922 LM	FUTURA T.PALO 27W 143X50° IP66 230V 2200K	379,00 €
FUTP27T1MAM	2200 K	140°X60°	3996 LM	3031 LM	FUTURA T.PALO 27W 140X60° IP66 230V 2200K	379,00 €
FUTP27T2AM	2200 K	151°X81°	3996 LM	2987 LM	FUTURA T.PALO 27W 151X81° IP66 230V 2200K	379,00 €
FUTP27C50AM	2200 K	CON 50°	3996 LM	2943 LM	FUTURA T.PALO 27W C50° IP66 230V 2200K	379,00 €
FUTP27D55AM	2200 K	DIFF 55°	3996 LM	2900 LM	FUTURA T.PALO 27W D55° IP66 230V 2200K	379,00 €
FUTP27TCOC	3000 K	150°X75°	4401 LM	3488 LM	FUTURA T.PALO 27W 143X50° IP66 230V 3000K	379,00 €
FUTP27T1SC	3000 K	143°X50°	4401 LM	3437 LM	FUTURA T.PALO 27W 140X60° IP66 230V 3000K	379,00 €
FUTP27T1MC	3000 K	140°X60°	4401 LM	3565 LM	FUTURA T.PALO 27W 151X81° IP66 230V 3000K	379,00 €
FUTP27T2C	3000 K	151°X81°	4401 LM	3514 LM	FUTURA T.PALO 27W C50° IP66 230V 3000K	379,00 €
FUTP27C50C	3000 K	CON 50°	4401 LM	3463 LM	FUTURA T.PALO 27W D55° IP66 230V 3000K	379,00 €
FUTP27D55C	3000 K	DIFF 55°	4401 LM	3411 LM	FUTURA T.PALO 27W D55° IP66 230V 3000K	379,00 €
FUTP27TCON	4000 K	150°X75°	4644 LM	3672 LM	FUTURA T.PALO 27W 150X75° IP66 230V 4000K	379,00 €
FUTP27T1SN	4000 K	143°X50°	4644 LM	3618 LM	FUTURA T.PALO 27W 143X50° IP66 230V 4000K	379,00 €
FUTP27T1MN	4000 K	140°X60°	4644 LM	3753 LM	FUTURA T.PALO 27W 140X60° IP66 230V 4000K	379,00 €
FUTP27T2N	4000 K	151°X81°	4644 LM	3699 LM	FUTURA T.PALO 27W 151X81° IP66 230V 4000K	379,00 €
FUTP27C50N	4000 K	CON 50°	4644 LM	3645 LM	FUTURA T.PALO 27W C50° IP66 230V 4000K	379,00 €
FUTP27D55N	4000 K	DIFF 55°	4644 LM	3591 LM	FUTURA T.PALO 27W D55° IP66 230V 4000K	379,00 €

FUTURA TP50

CODICE	TEMP.COL	ANG.	NOMIN	LUMEN USCENTI TE°=25	DESCRIZIONE METEL	LISTINO IVA ESCLUSA
SIMMETRICI						
FUTP5030AM	2200 K	30°	7400 LM	5774 LM	FUTURA T.PALO 50W 30° IP66 230V 2200K	400,00 €
FUTP5060AM	2200 K	60°	7400 LM	5693 LM	FUTURA T.PALO 50W 60° IP66 230V 2200K	400,00 €
FUTP5090AM	2200 K	90°	7400 LM	5653 LM	FUTURA T.PALO 50W 90° IP66 230V 2200K	400,00 €
FUTP5030C	3000 K	30°	8150 LM	6793 LM	FUTURA T.PALO 50W 30° IP66 230V 3000K	400,00 €
FUTP5060C	3000 K	60°	8150 LM	6698 LM	FUTURA T.PALO 50W 60° IP66 230V 3000K	400,00 €
FUTP5090C	3000 K	90°	8150 LM	6650 LM	FUTURA T.PALO 50W 90° IP66 230V 3000K	400,00 €
FUTP5030N	4000 K	30°	8600 LM	7150 LM	FUTURA T.PALO 50W 30° IP66 230V 4000K	400,00 €
FUTP5060N	4000 K	60°	8600 LM	7050 LM	FUTURA T.PALO 50W 60° IP66 230V 4000K	400,00 €
FUTP5090N	4000 K	90°	8600 LM	7000 LM	FUTURA T.PALO 50W 90° IP66 230V 4000K	400,00 €
ASIMMETRICI						
FUTP50TCOAM	2200 K	150°X75°	7400 LM	5491 LM	FUTURA T.PALO 50W 150X75° IP66 230V 2200K	400,00 €
FUTP50T1SAM	2200 K	143°X50°	7400 LM	5410 LM	FUTURA T.PALO 50W 143X50° IP66 230V 2200K	400,00 €
FUTP50T1MAM	2200 K	140°X60°	7400 LM	5612 LM	FUTURA T.PALO 50W 140X60° IP66 230V 2200K	400,00 €
FUTP50T2AM	2200 K	151°X81°	7400 LM	5531 LM	FUTURA T.PALO 50W 151X81° IP66 230V 2200K	400,00 €
FUTP50C50AM	2200 K	CON 50°	7400 LM	5451 LM	FUTURA T.PALO 50W C50° IP66 230V 2200K	400,00 €
FUTP50D55AM	2200 K	DIFF 55°	7400 LM	5370 LM	FUTURA T.PALO 50W D55° IP66 230V 2200K	400,00 €
FUTP50TCOC	3000 K	150°X75°	8150 LM	6460 LM	FUTURA T.PALO 50W 150X75° IP66 230V 3000K	400,00 €
FUTP50T1SC	3000 K	143°X50°	8150 LM	6365 LM	FUTURA T.PALO 50W 143X50° IP66 230V 3000K	400,00 €
FUTP50T1MC	3000 K	140°X60°	8150 LM	6603 LM	FUTURA T.PALO 50W 140X60° IP66 230V 3000K	400,00 €
FUTP50T2C	3000 K	151°X81°	8150 LM	6508 LM	FUTURA T.PALO 50W 151X81° IP66 230V 3000K	400,00 €
FUTP50C50C	3000 K	CON 50°	8150 LM	6413 LM	FUTURA T.PALO 50W C50° IP66 230V 3000K	400,00 €
FUTP50D55C	3000 K	DIFF 55°	8150 LM	6318 LM	FUTURA T.PALO 50W D55° IP66 230V 3000K	400,00 €
FUTP50TCON	4000 K	150°X75°	8600 LM	6800 LM	FUTURA T.PALO 50W 150X75° IP66 230V 4000K	400,00 €
FUTP50T1SN	4000 K	143°X50°	8600 LM	6700 LM	FUTURA T.PALO 50W 143X50° IP66 230V 4000K	400,00 €
FUTP50T1MN	4000 K	140°X60°	8600 LM	6950 LM	FUTURA T.PALO 50W 140X60° IP66 230V 4000K	400,00 €
FUTP50T2N	4000 K	151°X81°	8600 LM	6850 LM	FUTURA T.PALO 50W 151X81° IP66 230V 4000K	400,00 €
FUTP50C50N	4000 K	CON 50°	8600 LM	6750 LM	FUTURA T.PALO 50W C50° IP66 230V 4000K	400,00 €
FUTP50D55N	4000 K	DIFF 55°	8600 LM	6650 LM	FUTURA T.PALO 50W D55° IP66 230V 4000K	400,00 €

CARATTERISTICHE GENERALI	
GRADO DI PROTEZIONE	IP66
IK	09
PESO	4500 G
CARATTERISTICHE ILLUMINAZIONE	
TIPO LED	3030
RESA CROMATICA	80
RG	01
MANTENIMENTO FLUSSO	90% 100000H (L90B10)
TOLLER. FLUSSO LUMINOSO	=+/- 7%
CARATTERISTICHE ELETTRICHE	
WATT	27W-50W-72W-108W
TOLLERANZA CONSUMO	=+/- 10%
SORGENTI LUMINOSE	96
ALIMENTAZIONE	230V

DIMMERABILE	A RICHIESTA
FATTORE DI POTENZA	0,95
INDICE DI MANUTENZIONE	0,95
MATERIALE FINITURE	
CORPO	ALLUMINIO PRESSOFUSO VERNICIATO A POLVERE
FINITURA	RAL9005
SCHERMO	VETRO TEMPERATO
CAVO	2X1.00 NEOPRENE
PRESSACAPO	NYLON
TEMPERATURE	
STOCCAGGIO	DA -35°C A +50°C
FUNZIONAMENTO	DA -35°C A +80°C
AFFIDABILITÀ	FINO A 7 ANNI DI GARANZIA
RICICLABILITÀ	95%

FUTURA TP72

CODICE	TEMP.COL	ANG.	NOMIN	LUMEN USCENTI TE°=25	DESCRIZIONE METEL	LISTINO IVA ESCLUSA
SIMMETRICI						
FUTP7230AM	2200 K	30°	10656 LM	8314 LM	FUTURA T.PALO 72W 30° IP66 230V 2200K	406,00 €
FUTP7260AM	2200 K	60°	10656 LM	8198 LM	FUTURA T.PALO 72W 60° IP66 230V 2200K	406,00 €
FUTP7290AM	2200 K	90°	10656 LM	8140 LM	FUTURA T.PALO 72W 90° IP66 230V 2200K	406,00 €
FUTP7230C	3000 K	30°	11736 LM	9781 LM	FUTURA T.PALO 72W 30° IP66 230V 3000K	406,00 €
FUTP7260C	3000 K	60°	11736 LM	9644 LM	FUTURA T.PALO 72W 60° IP66 230V 3000K	406,00 €
FUTP7290C	3000 K	90°	11736 LM	9576 LM	FUTURA T.PALO 72W 90° IP66 230V 3000K	406,00 €
FUTP7230N	4000 K	30°	12384 LM	10296 LM	FUTURA T.PALO 72W 30° IP66 230V 4000K	406,00 €
FUTP7260N	4000 K	60°	12384 LM	10152 LM	FUTURA T.PALO 72W 60° IP66 230V 4000K	406,00 €
FUTP7290N	4000 K	90°	12384 LM	10080 LM	FUTURA T.PALO 72W 90° IP66 230V 4000K	406,00 €
ASIMMETRICI						
FUTP72TCOAM	2200 K	150°X75°	10656 LM	7907 LM	FUTURA T.PALO 72W 150X75° IP66 230V 2200K	406,00 €
FUTP72T1SAM	2200 K	143°X50°	10656 LM	7791 LM	FUTURA T.PALO 72W 143X50° IP66 230V 2200K	406,00 €
FUTP72T1MAM	2200 K	140°X60°	10656 LM	8081 LM	FUTURA T.PALO 72W 140X60° IP66 230V 2200K	406,00 €
FUTP72T2AM	2200 K	151°X81°	10656 LM	7965 LM	FUTURA T.PALO 72W 151X81° IP66 230V 2200K	406,00 €
FUTP72C50AM	2200 K	CON 50°	10656 LM	7849 LM	FUTURA T.PALO 72W C50° IP66 230V 2200K	406,00 €
FUTP72D55AM	2200 K	DIFF 55°	10656 LM	7733 LM	FUTURA T.PALO 72W D55° IP66 230V 2200K	406,00 €
FUTP72TCOC	3000 K	150°X75°	11736 LM	9302 LM	FUTURA T.PALO 72W 150X75° IP66 230V 3000K	406,00 €
FUTP72T1SC	3000 K	143°X50°	11736 LM	9166 LM	FUTURA T.PALO 72W 143X50° IP66 230V 3000K	406,00 €
FUTP72T1MC	3000 K	140°X60°	11736 LM	9508 LM	FUTURA T.PALO 72W 140X60° IP66 230V 3000K	406,00 €
FUTP72T2C	3000K	151°X81°	11736 LM	9371 LM	FUTURA T.PALO 72W 151X81° IP66 230V 3000K	406,00 €
FUTP72C50C	3000 K	CON 50°	11736 LM	9234 LM	FUTURA T.PALO 72W C50° IP66 230V 3000K	406,00 €
FUTP72D55C	3000 K	DIFF 55°	11736 LM	9097 LM	FUTURA T.PALO 72W D55° IP66 230V 3000K	406,00 €
FUTP72TCON	4000 K	150°X75°	12384 LM	9792 LM	FUTURA T.PALO 72W 150X75° IP66 230V 4000K	406,00 €
FUTP72T1SN	4000 K	143°X50°	12384 LM	9648 LM	FUTURA T.PALO 72W 143X50° IP66 230V 4000K	406,00 €
FUTP72T1MN	4000 K	140°X60°	12384 LM	10008 LM	FUTURA T.PALO 72W 140X60° IP66 230V 4000K	406,00 €
FUTP72T2N	4000 K	151°X81°	12384 LM	9864 LM	FUTURA T.PALO 72W 151X81° IP66 230V 4000K	406,00 €
FUTP72C50N	4000 K	CON 50°	12384 LM	9720 LM	FUTURA T.PALO 72W C50° IP66 230V 4000K	406,00 €
FUTP72D55N	4000 K	DIFF 55°	12384 LM	9576 LM	FUTURA T.PALO 72W D55° IP66 230V 4000K	406,00 €

FUTURA TP108

CODICE	TEMP.COL	ANG.	NOMIN	LUMEN USCENTI TE°=25	DESCRIZIONE METEL	LISTINO IVA ESCLUSA
SIMMETRICI						
FUTP10830AM	2200 K	30°	15984 LM	12471 LM	FUTURA T.PALO 108W 30° IP66 230V 2200K	418,00 €
FUTP10860AM	2200 K	60°	15984 LM	12297 LM	FUTURA T.PALO 108W 60° IP66 230V 2200K	418,00 €
FUTP10890AM	2200 K	90°	15984 LM	12209 LM	FUTURA T.PALO 108W 90° IP66 230V 2200K	418,00 €
FUTP10830C	3000 K	30°	17604 LM	14672 LM	FUTURA T.PALO 108W 30° IP66 230V 3000K	418,00 €
FUTP10860C	3000 K	60°	17604 LM	14467 LM	FUTURA T.PALO 108W 60° IP66 230V 3000K	418,00 €
FUTP10890C	3000 K	90°	17604 LM	14364 LM	FUTURA T.PALO 108W 90° IP66 230V 3000K	418,00 €
FUTP10830N	4000 K	30°	18576 LM	15444 LM	FUTURA T.PALO 108W 30° IP66 230V 4000K	418,00 €
FUTP10860N	4000 K	60°	18576 LM	15228 LM	FUTURA T.PALO 108W 60° IP66 230V 4000K	418,00 €
FUTP10890N	4000 K	90°	18576 LM	15120 LM	FUTURA T.PALO 108W 90° IP66 230V 4000K	418,00 €
ASIMMETRICI						
FUTP108TCOAM	2200 K	150°X75°	15984 LM	11861 LM	FUTURA T.PALO 108W 150X75° IP66 230V 2200K	418,00 €
FUTP108T1SAM	2200 K	143°X50°	15984 LM	11686 LM	FUTURA T.PALO 108W 143X50° IP66 230V 2200K	418,00 €
FUTP108T1MAM	2200 K	140°X60°	15984 LM	12122 LM	FUTURA T.PALO 108W 140X60° IP66 230V 2200K	418,00 €
FUTP108T2AM	2200 K	151°X81°	15984 LM	11948 LM	FUTURA T.PALO 108W 151X81° IP66 230V 2200K	418,00 €
FUTP108C50AM	2200 K	CON 50°	15984 LM	11773 LM	FUTURA T.PALO 108W C50° IP66 230V 2200K	418,00 €
FUTP108D55AM	2200 K	DIFF 55°	15984 LM	11599 LM	FUTURA T.PALO 108W D55° IP66 230V 2200K	418,00 €
FUTP108TCOC	3000 K	150°X75°	17604 LM	13954 LM	FUTURA T.PALO 108W 150X75° IP66 230V 3000K	418,00 €
FUTP108T1SC	3000 K	143°X50°	17604 LM	13748 LM	FUTURA T.PALO 108W 143X50° IP66 230V 3000K	418,00 €
FUTP108T1MC	3000 K	140°X60°	17604 LM	14261 LM	FUTURA T.PALO 108W 140X60° IP66 230V 3000K	418,00 €
FUTP108T2C	3000 K	151°X81°	17604 LM	14056 LM	FUTURA T.PALO 108W 151X81° IP66 230V 3000K	418,00 €
FUTP108C50C	3000 K	CON 50°	17604 LM	13851 LM	FUTURA T.PALO 108W C50° IP66 230V 3000K	418,00 €
FUTP108D55C	3000 K	DIFF 55°	17604 LM	13646 LM	FUTURA T.PALO 108W D55° IP66 230V 3000K	418,00 €
FUTP108TCON	4000 K	150°X75°	18576 LM	14688 LM	FUTURA T.PALO 108W 150X75° IP66 230V 4000K	418,00 €
FUTP108T1SN	4000 K	143°X50°	18576 LM	14472 LM	FUTURA T.PALO 108W 143X50° IP66 230V 4000K	418,00 €
FUTP108T1MN	4000 K	140°X60°	18576 LM	15012 LM	FUTURA T.PALO 108W 140X60° IP66 230V 4000K	418,00 €
FUTP108T2N	4000 K	151°X81°	18576 LM	14796 LM	FUTURA T.PALO 108W 151X81° IP66 230V 4000K	418,00 €
FUTP108C50N	4000 K	CON 50°	18576 LM	14580 LM	FUTURA T.PALO 108W C50° IP66 230V 4000K	418,00 €
FUTP108D55N	4000 K	DIFF 55°	18576 LM	14364 LM	FUTURA T.PALO 108W D55° IP66 230V 4000K	418,00 €

FUTURA TP

MONOEMISSIONE

FASCI DI LUCE

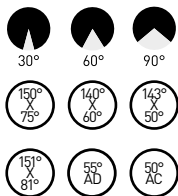

CONSUMO



ALIMENTAZIONE



APPLICAZIONE

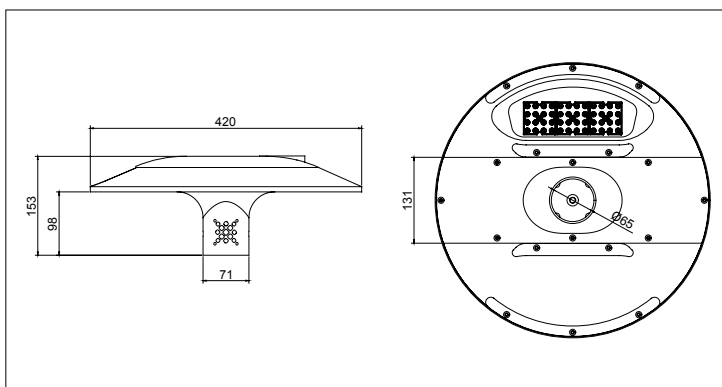

FUTURA TP25

CODICE	TEMP.COL	ANG.	NOMIN	LUMEN USCENTI TE°=25	DESCRIZIONE METEL	LISTINO IVA ESCLUSA
SIMMETRICI						
FUTP2530AM	2200 K	30°	3700 LM	2887 LM	FUTURA T.PALO 25W 30° IP66 230V 2200K	365,00 €
FUTP2560AM	2200 K	60°	3700 LM	2846 LM	FUTURA T.PALO 25W 60° IP66 230V 2200K	365,00 €
FUTP2590AM	2200 K	90°	3700 LM	2826 LM	FUTURA T.PALO 25W 90° IP66 230V 2200K	365,00 €
FUTP2530C	3000 K	30°	4075 LM	3396 LM	FUTURA T.PALO 25W 30° IP66 230V 3000K	365,00 €
FUTP2560C	3000 K	60°	4075 LM	3349 LM	FUTURA T.PALO 25W 60° IP66 230V 3000K	365,00 €
FUTP2590C	3000 K	90°	4075 LM	3325 LM	FUTURA T.PALO 25W 90° IP66 230V 3000K	365,00 €
FUTP2530N	4000 K	30°	4300 LM	3575 LM	FUTURA T.PALO 25W 30° IP66 230V 4000K	365,00 €
FUTP2560N	4000 K	60°	4300 LM	3525 LM	FUTURA T.PALO 25W 60° IP66 230V 4000K	365,00 €
FUTP2590N	4000 K	90°	4300 LM	3500 LM	FUTURA T.PALO 25W 90° IP66 230V 4000K	365,00 €
ASIMMETRICI						
FUTP25TCOAM	2200 K	150°X75°	3700 LM	2746 LM	FUTURA T.PALO 25W 150X75° IP66 230V 2200K	365,00 €
FUTP25T1SAM	2200 K	143°X50°	3700 LM	2705 LM	FUTURA T.PALO 25W 143X50° IP66 230V 2200K	365,00 €
FUTP25T1MAM	2200 K	140°X60°	3700 LM	2806 LM	FUTURA T.PALO 25W 140X60° IP66 230V 2200K	365,00 €
FUTP25T2AM	2200 K	151°X81°	3700 LM	2766 LM	FUTURA T.PALO 25W 151X81° IP66 230V 2200K	365,00 €
FUTP25C50AM	2200 K	CON 50°	3700 LM	2725 LM	FUTURA T.PALO 25W C50° IP66 230V 2200K	365,00 €
FUTP25D55AM	2200 K	DIFF 55°	3700 LM	2685 LM	FUTURA T.PALO 25W D55° IP66 230V 2200K	365,00 €
FUTP25TCOC	3000K	150°X75°	4075 LM	3230 LM	FUTURA T.PALO 25W 150X75° IP66 230V 3000K	365,00 €
FUTP25T1SC	3000K	143°X50°	4075 LM	3183 LM	FUTURA T.PALO 25W 143X50° IP66 230V 3000K	365,00 €
FUTP25T1MC	3000K	140°X60°	4075 LM	3301 LM	FUTURA T.PALO 25W 140X60° IP66 230V 3000K	365,00 €
FUTP25T2C	3000K	151°X81°	4075 LM	3254 LM	FUTURA T.PALO 25W 151X81° IP66 230V 3000K	365,00 €
FUTP25C50C	3000K	CON 50°	4075 LM	3206 LM	FUTURA T.PALO 25W C50° IP66 230V 3000K	365,00 €
FUTP25D55C	3000K	DIFF 55°	4075 LM	3159 LM	FUTURA T.PALO 25W D55° IP66 230V 3000K	365,00 €
FUTP25TCON	4000 K	150°X75°	4300 LM	3400 LM	FUTURA T.PALO 25W 150X75° IP66 230V 4000K	365,00 €
FUTP25T1SN	4000 K	143°X50°	4300 LM	3350 LM	FUTURA T.PALO 25W 143X50° IP66 230V 4000K	365,00 €
FUTP25T1MN	4000 K	140°X60°	4300 LM	3475 LM	FUTURA T.PALO 25W 140X60° IP66 230V 4000K	365,00 €
FUTP25T2N	4000 K	151°X81°	4300 LM	3425 LM	FUTURA T.PALO 25W 151X81° IP66 230V 4000K	365,00 €
FUTP25C50N	4000 K	CON 50°	4300 LM	3375 LM	FUTURA T.PALO 25W C50° IP66 230V 4000K	365,00 €
FUTP25D55N	4000 K	DIFF 55°	4300 LM	3325 LM	FUTURA T.PALO 25W D55° IP66 230V 4000K	365,00 €

FUTURA TP36

CODICE	TEMP.COL	ANG.	NOMIN	LUMEN USCENTI TE°=25	DESCRIZIONE METEL	LISTINO IVA ESCLUSA
SIMMETRICI						
FUTP3630AM	2200 K	30°	5328 LM	4157 LM	FUTURA T.PALO 36W 30° IP66 230V 2200K	379,00 €
FUTP3660AM	2200 K	60°	5328 LM	4099 LM	FUTURA T.PALO 36W 60° IP66 230V 2200K	379,00 €
FUTP3690AM	2200 K	90°	5328 LM	4070 LM	FUTURA T.PALO 36W 90° IP66 230V 2200K	379,00 €
FUTP3630C	3000 K	30°	5868 LM	4891 LM	FUTURA T.PALO 36W 30° IP66 230V 3000K	379,00 €
FUTP3660C	3000 K	60°	5868 LM	4822 LM	FUTURA T.PALO 36W 60° IP66 230V 3000K	379,00 €
FUTP3690C	3000 K	90°	5868 LM	4788 LM	FUTURA T.PALO 36W 90° IP66 230V 3000K	379,00 €
FUTP3630N	4000 K	30°	6192 LM	5148 LM	FUTURA T.PALO 36W 30° IP66 230V 4000K	379,00 €
FUTP3660N	4000 K	60°	6192 LM	5076 LM	FUTURA T.PALO 36W 60° IP66 230V 4000K	379,00 €
FUTP3690N	4000 K	90°	6192 LM	5040 LM	FUTURA T.PALO 36W 90° IP66 230V 4000K	379,00 €
ASIMMETRICI						
FUTP36TCOAM	2200 K	150°X75°	5328 LM	3954 LM	FUTURA T.PALO 36W 150X75° IP66 230V 2200K	379,00 €
FUTP36T1SAM	2200 K	143°X50°	5328 LM	3895 LM	FUTURA T.PALO 36W 143X50° IP66 230V 2200K	379,00 €
FUTP36T1MAM	2200 K	140°X60°	5328 LM	4041 LM	FUTURA T.PALO 36W 140X60° IP66 230V 2200K	379,00 €
FUTP36T2AM	2200 K	151°X81°	5328 LM	3983 LM	FUTURA T.PALO 36W 151X81° IP66 230V 2200K	379,00 €
FUTP36C50AM	2200 K	CON 50°	5328 LM	3924 LM	FUTURA T.PALO 36W C50° IP66 230V 2200K	379,00 €
FUTP36D55AM	2200 K	DIFF 55°	5328 LM	3866 LM	FUTURA T.PALO 36W D55° IP66 230V 2200K	379,00 €
FUTP36TCOC	3000K	150°X75°	5868 LM	4651 LM	FUTURA T.PALO 36W 150X75° IP66 230V 3000K	379,00 €
FUTP36T1SC	3000K	143°X50°	5868 LM	4583 LM	FUTURA T.PALO 36W 143X50° IP66 230V 3000K	379,00 €
FUTP36T1MC	3000K	140°X60°	5868 LM	4754 LM	FUTURA T.PALO 36W 140X60° IP66 230V 3000K	379,00 €
FUTP36T2C	3000K	151°X81°	5868 LM	4685 LM	FUTURA T.PALO 36W 151X81° IP66 230V 3000K	379,00 €
FUTP36C50C	3000K	CON 50°	5868 LM	4617 LM	FUTURA T.PALO 36W C50° IP66 230V 3000K	379,00 €
FUTP36D55C	3000K	DIFF 55°	5868 LM	4549 LM	FUTURA T.PALO 36W D55° IP66 230V 3000K	379,00 €
FUTP36TCON	4000 K	150°X75°	6192 LM	4896 LM	FUTURA T.PALO 36W 150X75° IP66 230V 4000K	379,00 €
FUTP36T1SN	4000 K	143°X50°	6192 LM	4824 LM	FUTURA T.PALO 36W 143X50° IP66 230V 4000K	379,00 €
FUTP36T1MN	4000 K	140°X60°	6192 LM	5004 LM	FUTURA T.PALO 36W 140X60° IP66 230V 4000K	379,00 €
FUTP36T2N	4000 K	151°X81°	6192 LM	4932 LM	FUTURA T.PALO 36W 151X81° IP66 230V 4000K	379,00 €
FUTP36C50N	4000 K	CON 50°	6192 LM	4860 LM	FUTURA T.PALO 36W C50° IP66 230V 4000K	379,00 €
FUTP36D55N	4000 K	DIFF 55°	6192 LM	4788 LM	FUTURA T.PALO 36W D55° IP66 230V 4000K	379,00 €

CARATTERISTICHE GENERALI	
GRADO DI PROTEZIONE	IP66
IK	09
PESO	4500 G
CARATTERISTICHE ILLUMINAZIONE	
TIPO LED	3030
RESA CROMATICA	80
RG	01
MANTENIMENTO FLUSSO	90% 100000H (L90B10)
TOLLER. FLUSSO LUMINOSO	=+/- 7%
CARATTERISTICHE ELETTRICHE	
WATT	25W-36W-54W
TOLLERANZA CONSUMO	=+/- 10%
SORGENTI LUMINOSE	48
ALIMENTAZIONE	230V

DIMMERABILE	A RICHIESTA
FATTORE DI POTENZA	0,95
INDICE DI MANUTENZIONE	0,95
MATERIALE FINITURE	
CORPO	ALLUMINIO PRESSOFUSO VERNICIATO A POLVERE
FINITURA	RAL9005
SCHERMO	VETRO TEMPERATO
CAVO	2X1.00 NEOPRENE
PRESSACAVO	NYLON
TEMPERATURE	
STOCCAGGIO	DA -35°C A +50°C
FUNZIONAMENTO	DA -35°C A +80°C
AFFIDABILITÀ	FINO A 7 ANNI DI GARANZIA
RICICLABILITÀ	95%

FUTURA TP54

CODICE	TEMP.COL	ANG.	NOMIN	LUMEN		DESCRIZIONE METEL	LISTINO IVA ESCLUSA
				USCENTI	TE°=25		
SIMMETRICI							
FUTP5430AM	2200 K	30°	4500 LM	7992 LM		FUTURA T.PALO 54W 30° IP66 230V 2200K	394,00 €
FUTP5460AM	2200 K	60°	4500 LM	7992 LM		FUTURA T.PALO 54W 60° IP66 230V 2200K	394,00 €
FUTP5490AM	2200 K	90°	4500 LM	7992 LM		FUTURA T.PALO 54W 90° IP66 230V 2200K	394,00 €
FUTP5430C	3000 K	30°	4500 LM	8802 LM		FUTURA T.PALO 54W 30° IP66 230V 3000K	394,00 €
FUTP5460C	3000 K	60°	4500 LM	8802 LM		FUTURA T.PALO 54W 60° IP66 230V 3000K	394,00 €
FUTP5490C	3000 K	90°	4500 LM	8802 LM		FUTURA T.PALO 54W 90° IP66 230V 3000K	394,00 €
FUTP5430N	4000 K	30°	4500 LM	9288 LM		FUTURA T.PALO 54W 30° IP66 230V 4000K	394,00 €
FUTP5460N	4000 K	60°	4500 LM	9288 LM		FUTURA T.PALO 54W 60° IP66 230V 4000K	394,00 €
FUTP5490N	4000 K	90°	4500 LM	9288 LM		FUTURA T.PALO 54W 90° IP66 230V 4000K	394,00 €
ASIMMETRICI							
FUTP54TCOAM	2200 K	150°X75°	7992 LM	5930 LM		FUTURA T.PALO 54W 150X75° IP66 230V 2200K	394,00 €
FUTP54T1SAM	2200 K	143°X50°	7992 LM	5843 LM		FUTURA T.PALO 54W 143X50° IP66 230V 2200K	394,00 €
FUTP54T1MAM	2200 K	140°X60°	7992 LM	6061 LM		FUTURA T.PALO 54W 140X60° IP66 230V 2200K	394,00 €
FUTP54T2AM	2200 K	151°X81°	7992 LM	5974 LM		FUTURA T.PALO 54W 151X81° IP66 230V 2200K	394,00 €
FUTP54C50AM	2200 K	CON 50°	7992 LM	5887 LM		FUTURA T.PALO 54W C50° IP66 230V 2200K	394,00 €
FUTP54D55AM	2200 K	DIFF 55°	7992 LM	5799 LM		FUTURA T.PALO 54W D55° IP66 230V 2200K	394,00 €
FUTP54TCOC	3000K	150°X75°	8802 LM	6977 LM		FUTURA T.PALO 54W 150X75° IP66 230V 3000K	394,00 €
FUTP54T1SC	3000K	143°X50°	8802 LM	6874 LM		FUTURA T.PALO 54W 143X50° IP66 230V 3000K	394,00 €
FUTP54T1MC	3000K	140°X60°	8802 LM	7131 LM		FUTURA T.PALO 54W 140X60° IP66 230V 3000K	394,00 €
FUTP54T2C	3000K	151°X81°	8802 LM	7028 LM		FUTURA T.PALO 54W 151X81° IP66 230V 3000K	394,00 €
FUTP54C50C	3000K	CON 50°	8802 LM	6926 LM		FUTURA T.PALO 54W C50° IP66 230V 3000K	394,00 €
FUTP54D55C	3000K	DIFF 55°	8802 LM	6823 LM		FUTURA T.PALO 54W D55° IP66 230V 3000K	394,00 €
FUTP54TCON	4000 K	150°X75°	9288 LM	7344 LM		FUTURA T.PALO 54W 150X75° IP66 230V 4000K	394,00 €
FUTP54T1SN	4000 K	143°X50°	9288 LM	7236 LM		FUTURA T.PALO 54W 143X50° IP66 230V 4000K	394,00 €
FUTP54T1MN	4000 K	140°X60°	9288 LM	7506 LM		FUTURA T.PALO 54W 140X60° IP66 230V 4000K	394,00 €
FUTP54T2N	4000 K	151°X81°	9288 LM	7398 LM		FUTURA T.PALO 54W 151X81° IP66 230V 4000K	394,00 €
FUTP54C50N	4000 K	CON 50°	9288 LM	7290 LM		FUTURA T.PALO 54W C50° IP66 230V 4000K	394,00 €
FUTP54D55N	4000 K	DIFF 55°	9288 LM	7182 LM		FUTURA T.PALO 54W D55° IP66 230V 4000K	394,00 €

FUTURA PR

FASCI DI LUCE

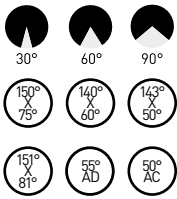

CONSUMO

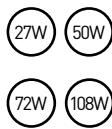

ALIMENTAZIONE



APPLICAZIONE

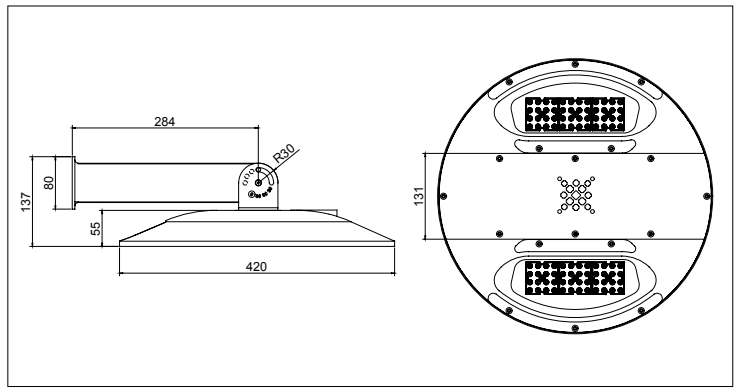

FUTURA PR27

CODICE	TEMP.COL	ANG.	NOMIN	LUMEN USCENTI TE°=25	DESCRIZIONE METEL	LISTINO IVA ESCLUSA
SIMMETRICI						
FUPR2730AM	2200 K	30°	3996 LM	3118 LM	FUTURA PARETE 27W 30° IP66 230V 2200K	409,00 €
FUPR2760AM	2200 K	60°	3996 LM	3074 LM	FUTURA PARETE 27W 60° IP66 230V 2200K	409,00 €
FUPR2790AM	2200 K	90°	3996 LM	3052 LM	FUTURA PARETE 27W 90° IP66 230V 2200K	409,00 €
FUPR2730C	3000 K	30°	4401 LM	3668 LM	FUTURA PARETE 27W 30° IP66 230V 3000K	409,00 €
FUPR2760C	3000 K	60°	4401 LM	3617 LM	FUTURA PARETE 27W 60° IP66 230V 3000K	409,00 €
FUPR2790C	3000 K	90°	4401 LM	3591 LM	FUTURA PARETE 27W 90° IP66 230V 3000K	409,00 €
FUPR2730N	4000 K	30°	4644 LM	3861 LM	FUTURA PARETE 27W 30° IP66 230V 4000K	409,00 €
FUPR2760N	4000 K	60°	4644 LM	3807 LM	FUTURA PARETE 27W 60° IP66 230V 4000K	409,00 €
FUPR2790N	4000 K	90°	4644 LM	3780 LM	FUTURA PARETE 27W 90° IP66 230V 4000K	409,00 €
ASIMMETRICI						
FUPR27TCOAM	2200 K	150°X75°	3996 LM	2965 LM	FUTURA PARETE 27W 150X75° IP66 230V 2200K	409,00 €
FUPR27T1SAM	2200 K	143°X50°	3996 LM	2922 LM	FUTURA PARETE 27W 143X50° IP66 230V 2200K	409,00 €
FUPR27T1MAM	2200 K	140°X60°	3996 LM	3031 LM	FUTURA PARETE 27W 140X60° IP66 230V 2200K	409,00 €
FUPR27T2AM	2200 K	151°X81°	3996 LM	2987 LM	FUTURA PARETE 27W 151X81° IP66 230V 2200K	409,00 €
FUPR27C50AM	2200 K	CON 50°	3996 LM	2943 LM	FUTURA PARETE 27W C50° IP66 230V 2200K	409,00 €
FUPR27D55AM	2200 K	DIFF 55°	3996 LM	2900 LM	FUTURA PARETE 27W D55° IP66 230V 2200K	409,00 €
FUPR27TCOC	3000K	150°X75°	4401 LM	3488 LM	FUTURA PARETE 27W 150X75° IP66 230V 3000K	409,00 €
FUPR27T15C	3000K	143°X50°	4401 LM	3437 LM	FUTURA PARETE 27W 143X50° IP66 230V 3000K	409,00 €
FUPR27T1MC	3000K	140°X60°	4401 LM	3565 LM	FUTURA PARETE 27W 140X60° IP66 230V 3000K	409,00 €
FUPR27T2C	3000K	151°X81°	4401 LM	3514 LM	FUTURA PARETE 27W 151X81° IP66 230V 3000K	409,00 €
FUPR27C50C	3000K	CON 50°	4401 LM	3463 LM	FUTURA PARETE 27W C50° IP66 230V 3000K	409,00 €
FUPR27D55C	3000K	DIFF 55°	4401 LM	3411 LM	FUTURA PARETE 27W D55° IP66 230V 3000K	409,00 €
FUPR27TCON	4000 K	150°X75°	4644 LM	3672 LM	FUTURA PARETE 27W 150X75° IP66 230V 4000K	409,00 €
FUPR27T15N	4000 K	143°X50°	4644 LM	3618 LM	FUTURA PARETE 27W 143X50° IP66 230V 4000K	409,00 €
FUPR27T1MN	4000 K	140°X60°	4644 LM	3753 LM	FUTURA PARETE 27W 140X60° IP66 230V 4000K	409,00 €
FUPR27T2N	4000 K	151°X81°	4644 LM	3699 LM	FUTURA PARETE 27W 151X81° IP66 230V 4000K	409,00 €
FUPR27C50N	4000 K	CON 50°	4644 LM	3645 LM	FUTURA PARETE 27W C50° IP66 230V 4000K	409,00 €
FUPR27D55N	4000 K	DIFF 55°	4644 LM	3591 LM	FUTURA PARETE 27W D55° IP66 230V 4000K	409,00 €

FUTURA PR50

CODICE	TEMP.COL	ANG.	NOMIN	LUMEN USCENTI TE°=25	DESCRIZIONE METEL	LISTINO IVA ESCLUSA
SIMMETRICI						
FUPR5030AM	2200 K	30°	7400 LM	5774 LM	FUTURA PARETE 50W 30° IP66 230V 2200K	421,00 €
FUPR5060AM	2200 K	60°	7400 LM	5693 LM	FUTURA PARETE 50W 60° IP66 230V 2200K	421,00 €
FUPR5090AM	2200 K	90°	7400 LM	5653 LM	FUTURA PARETE 50W 90° IP66 230V 2200K	421,00 €
FUPR5030C	3000 K	30°	8150 LM	6793 LM	FUTURA PARETE 50W 30° IP66 230V 3000K	421,00 €
FUPR5060C	3000 K	60°	8150 LM	6698 LM	FUTURA PARETE 50W 60° IP66 230V 3000K	421,00 €
FUPR5090C	3000 K	90°	8150 LM	6650 LM	FUTURA PARETE 50W 90° IP66 230V 3000K	421,00 €
FUPR5030N	4000 K	30°	8600 LM	7150 LM	FUTURA PARETE 50W 30° IP66 230V 4000K	421,00 €
FUPR5060N	4000 K	60°	8600 LM	7050 LM	FUTURA PARETE 50W 60° IP66 230V 4000K	421,00 €
FUPR5090N	4000 K	90°	8600 LM	7000 LM	FUTURA PARETE 50W 90° IP66 230V 4000K	421,00 €
ASIMMETRICI						
FUPR50TCOAM	2200 K	150°X75°	7400 LM	5491 LM	FUTURA PARETE 50W 150X75° IP66 230V 2200K	421,00 €
FUPR50T1SAM	2200 K	143°X50°	7400 LM	5410 LM	FUTURA PARETE 50W 143X50° IP66 230V 2200K	421,00 €
FUPR50T1MAM	2200 K	140°X60°	7400 LM	5612 LM	FUTURA PARETE 50W 140X60° IP66 230V 2200K	421,00 €
FUPR50T2AM	2200 K	151°X81°	7400 LM	5531 LM	FUTURA PARETE 50W 151X81° IP66 230V 2200K	421,00 €
FUPR50C50AM	2200 K	CON 50°	7400 LM	5451 LM	FUTURA PARETE 50W C50° IP66 230V 2200K	421,00 €
FUPR50D55AM	2200 K	DIFF 55°	7400 LM	5370 LM	FUTURA PARETE 50W D55° IP66 230V 2200K	421,00 €
FUPR50TCOC	3000K	150°X75°	8150 LM	6460 LM	FUTURA PARETE 50W 150X75° IP66 230V 3000K	421,00 €
FUPR50T15C	3000K	143°X50°	8150 LM	6365 LM	FUTURA PARETE 50W 143X50° IP66 230V 3000K	421,00 €
FUPR50T1MC	3000K	140°X60°	8150 LM	6603 LM	FUTURA PARETE 50W 140X60° IP66 230V 3000K	421,00 €
FUPR50T2C	3000K	151°X81°	8150 LM	6508 LM	FUTURA PARETE 50W 151X81° IP66 230V 3000K	421,00 €
FUPR50C50C	3000K	CON 50°	8150 LM	6413 LM	FUTURA PARETE 50W C50° IP66 230V 3000K	421,00 €
FUPR50D55C	3000K	DIFF 55°	8150 LM	6318 LM	FUTURA PARETE 50W D55° IP66 230V 3000K	421,00 €
FUPR50TCON	4000 K	150°X75°	8600 LM	6800 LM	FUTURA PARETE 50W 150X75° IP66 230V 4000K	421,00 €
FUPR50T15N	4000 K	143°X50°	8600 LM	6700 LM	FUTURA PARETE 50W 143X50° IP66 230V 4000K	421,00 €
FUPR50T1MN	4000 K	140°X60°	8600 LM	6950 LM	FUTURA PARETE 50W 140X60° IP66 230V 4000K	421,00 €
FUPR50T2N	4000 K	151°X81°	8600 LM	6850 LM	FUTURA PARETE 50W 151X81° IP66 230V 4000K	421,00 €
FUPR50C50N	4000 K	CON 50°	8600 LM	6750 LM	FUTURA PARETE 50W C50° IP66 230V 4000K	421,00 €
FUPR50D55N	4000 K	DIFF 55°	8600 LM	6650 LM	FUTURA PARETE 50W D55° IP66 230V 4000K	421,00 €

CARATTERISTICHE GENERALI	
GRADO DI PROTEZIONE	IP66
IK	09
PESO	4500 G
CARATTERISTICHE ILLUMINAZIONE	
TIPO LED	3030
RESA CROMATICA	80
RG	01
MANTENIMENTO FLUSSO	90% 100000H (L90B10)
TOLLER. FLUSSO LUMINOSO	=+/- 7%
CARATTERISTICHE ELETTRICHE	
WATT	27W-50W-72W-108W
TOLLERANZA CONSUMO	=+/- 10%
SORGENTI LUMINOSE	48-96
ALIMENTAZIONE	230V

DIMMERABILE	A RICHIESTA
FATTORE DI POTENZA	0,95
INDICE DI MANUTENZIONE	0,95
MATERIALE FINITURE	
CORPO	ALLUMINIO PRESSOFUSO VERNICIATO A POLVERE
FINITURA	RAL9005
SCHERMO	VETRO TEMPERATO
CAVO	2X1.00 NEOPRENE
PRESSACAVO	NYLON
TEMPERATURE	
STOCCAGGIO	DA -35°C A +50°C
FUNZIONAMENTO	DA -35°C A +80°C
AFFIDABILITÀ	FINO A 7 ANNI DI GARANZIA
RICICLABILITÀ	95%

FUTURA PR72

CODICE	TEMP.COL	ANG.	NOMIN	LUMEN USCENTI TE°=25	DESCRIZIONE METEL	LISTINO IVA ESCLUSA
SIMMETRICI						
FUPR7230AM	2200 K	30°	10656 LM	8314 LM	FUTURA PARETE 72W 30° IP66 230V 2200K	432,00 €
FUPR7260AM	2200 K	60°	10656 LM	8198 LM	FUTURA PARETE 72W 60° IP66 230V 2200K	432,00 €
FUPR7290AM	2200 K	90°	10656 LM	8140 LM	FUTURA PARETE 72W 90° IP66 230V 2200K	432,00 €
FUPR7230C	3000 K	30°	11736 LM	9781 LM	FUTURA PARETE 72W 30° IP66 230V 3000K	432,00 €
FUPR7260C	3000 K	60°	11736 LM	9644 LM	FUTURA PARETE 72W 60° IP66 230V 3000K	432,00 €
FUPR7290C	3000 K	90°	11736 LM	9576 LM	FUTURA PARETE 72W 90° IP66 230V 3000K	432,00 €
FUPR7230N	4000 K	30°	12384 LM	10296 LM	FUTURA PARETE 72W 30° IP66 230V 4000K	432,00 €
FUPR7260N	4000 K	60°	12384 LM	10152 LM	FUTURA PARETE 72W 60° IP66 230V 4000K	432,00 €
FUPR7290N	4000 K	90°	12384 LM	10080 LM	FUTURA PARETE 72W 90° IP66 230V 4000K	432,00 €
ASIMMETRICI						
FUPR72TCOAM	2200 K	150°X75°	10656 LM	7907 LM	FUTURA PARETE 72W 150X75° IP66 230V 2200K	432,00 €
FUPR72T1SAM	2200 K	143°X50°	10656 LM	7791 LM	FUTURA PARETE 72W 143X50° IP66 230V 2200K	432,00 €
FUPR72T1MAM	2200 K	140°X60°	10656 LM	8081 LM	FUTURA PARETE 72W 140X60° IP66 230V 2200K	432,00 €
FUPR72T2AM	2200 K	151°X81°	10656 LM	7965 LM	FUTURA PARETE 72W 151X81° IP66 230V 2200K	432,00 €
FUPR72C50AM	2200 K	CON 50°	10656 LM	7849 LM	FUTURA PARETE 72W C50° IP66 230V 2200K	432,00 €
FUPR72D55AM	2200 K	DIFF 55°	10656 LM	7733 LM	FUTURA PARETE 72W D55° IP66 230V 2200K	432,00 €
FUPR72TCOC	3000K	150°X75°	11736 LM	9302 LM	FUTURA PARETE 72W 150X75° IP66 230V 3000K	432,00 €
FUPR72T1SC	3000K	143°X50°	11736 LM	9166 LM	FUTURA PARETE 72W 143X50° IP66 230V 3000K	432,00 €
FUPR72T1MC	3000K	140°X60°	11736 LM	9508 LM	FUTURA PARETE 72W 140X60° IP66 230V 3000K	432,00 €
FUPR72T2C	3000K	151°X81°	11736 LM	9371 LM	FUTURA PARETE 72W 151X81° IP66 230V 3000K	432,00 €
FUPR72C50C	3000K	CON 50°	11736 LM	9234 LM	FUTURA PARETE 72W C50° IP66 230V 3000K	432,00 €
FUPR72D55C	3000K	DIFF 55°	11736 LM	9097 LM	FUTURA PARETE 72W D55° IP66 230V 3000K	432,00 €
FUPR72TCON	4000 K	150°X75°	12384 LM	9792 LM	FUTURA PARETE 72W 150X75° IP66 230V 4000K	432,00 €
FUPR72T1SN	4000 K	143°X50°	12384 LM	9648 LM	FUTURA PARETE 72W 143X50° IP66 230V 4000K	432,00 €
FUPR72T1MN	4000 K	140°X60°	12384 LM	10008 LM	FUTURA PARETE 72W 140X60° IP66 230V 4000K	432,00 €
FUPR72T2N	4000 K	151°X81°	12384 LM	9864 LM	FUTURA PARETE 72W 151X81° IP66 230V 4000K	432,00 €
FUPR72C50N	4000 K	CON 50°	12384 LM	9720 LM	FUTURA PARETE 72W C50° IP66 230V 4000K	432,00 €
FUPR72D55N	4000 K	DIFF 55°	12384 LM	9576 LM	FUTURA PARETE 72W D55° IP66 230V 4000K	432,00 €

FUTURA PR108

CODICE	TEMP.COL	ANG.	NOMIN	LUMEN USCENTI TE°=25	DESCRIZIONE METEL	LISTINO IVA ESCLUSA
SIMMETRICI						
FUPR10830AM	2200 K	30°	15984 LM	12471 LM	FUTURA PARETE 108W 30° IP66 230V 2200K	444,00 €
FUPR10860AM	2200 K	60°	15984 LM	12297 LM	FUTURA PARETE 108W 60° IP66 230V 2200K	444,00 €
FUPR10890AM	2200 K	90°	15984 LM	12209 LM	FUTURA PARETE 108W 90° IP66 230V 2200K	444,00 €
FUPR10830C	3000 K	30°	17604 LM	14672 LM	FUTURA PARETE 108W 30° IP66 230V 3000K	444,00 €
FUPR10860C	3000 K	60°	17604 LM	14467 LM	FUTURA PARETE 108W 60° IP66 230V 3000K	444,00 €
FUPR10890C	3000 K	90°	17604 LM	14364 LM	FUTURA PARETE 108W 90° IP66 230V 3000K	444,00 €
FUPR10830N	4000 K	30°	18576 LM	15444 LM	FUTURA PARETE 108W 30° IP66 230V 4000K	444,00 €
FUPR10860N	4000 K	60°	18576 LM	15228 LM	FUTURA PARETE 108W 60° IP66 230V 4000K	444,00 €
FUPR10890N	4000 K	90°	18576 LM	15120 LM	FUTURA PARETE 108W 90° IP66 230V 4000K	444,00 €
ASIMMETRICI						
FUPR108TCOAM	2200 K	150°X75°	15984 LM	11861 LM	FUTURA PARETE 108W 150X75° IP66 230V 2200K	444,00 €
FUPR108T1SAM	2200 K	143°X50°	15984 LM	11686 LM	FUTURA PARETE 108W 143X50° IP66 230V 2200K	444,00 €
FUPR108T1MAM	2200 K	140°X60°	15984 LM	12122 LM	FUTURA PARETE 108W 140X60° IP66 230V 2200K	444,00 €
FUPR108T2AM	2200 K	151°X81°	15984 LM	11948 LM	FUTURA PARETE 108W 151X81° IP66 230V 2200K	444,00 €
FUPR108C50AM	2200 K	CON 50°	15984 LM	11773 LM	FUTURA PARETE 108W C50° IP66 230V 2200K	444,00 €
FUPR108D55AM	2200 K	DIFF 55°	15984 LM	11599 LM	FUTURA PARETE 108W D55° IP66 230V 2200K	444,00 €
FUPR108TCOC	3000K	150°X75°	17604 LM	13954 LM	FUTURA PARETE 108W 150X75° IP66 230V 3000K	444,00 €
FUPR108T1SC	3000K	143°X50°	17604 LM	13748 LM	FUTURA PARETE 108W 143X50° IP66 230V 3000K	444,00 €
FUPR108T1MC	3000K	140°X60°	17604 LM	14261 LM	FUTURA PARETE 108W 140X60° IP66 230V 3000K	444,00 €
FUPR108T2C	3000K	151°X81°	17604 LM	14056 LM	FUTURA PARETE 108W 151X81° IP66 230V 3000K	444,00 €
FUPR108C50C	3000K	CON 50°	17604 LM	13851 LM	FUTURA PARETE 108W C50° IP66 230V 3000K	444,00 €
FUPR108D55C	3000K	DIFF 55°	17604 LM	13646 LM	FUTURA PARETE 108W D55° IP66 230V 3000K	444,00 €
FUPR108TCON	4000 K	150°X75°	18576 LM	14688 LM	FUTURA PARETE 108W 150X75° IP66 230V 4000K	444,00 €
FUPR108T1SN	4000 K	143°X50°	18576 LM	14472 LM	FUTURA PARETE 108W 143X50° IP66 230V 4000K	444,00 €
FUPR108T1MN	4000 K	140°X60°	18576 LM	15012 LM	FUTURA PARETE 108W 140X60° IP66 230V 4000K	444,00 €
FUPR108T2N	4000 K	151°X81°	18576 LM	14796 LM	FUTURA PARETE 108W 151X81° IP66 230V 4000K	444,00 €
FUPR108C50N	4000 K	CON 50°	18576 LM	14580 LM	FUTURA PARETE 108W C50° IP66 230V 4000K	444,00 €
FUPR108D55N	4000 K	DIFF 55°	18576 LM	14364 LM	FUTURA PARETE 108W D55° IP66 230V 4000K	444,00 €

FUTURA TS

FASCI DI LUCE

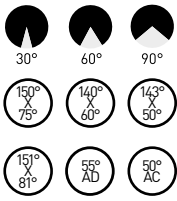

CONSUMO

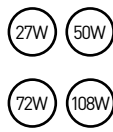

ALIMENTAZIONE



APPLICAZIONE

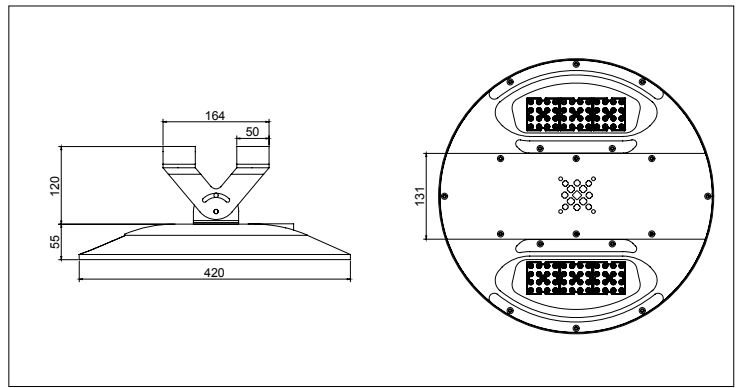

FUTURA TS27

CODICE	TEMP.COL	ANG.	NOMIN	LUMEN USCENTI TE°=25	DESCRIZIONE METEL	LISTINO IVA ESCLUSA
SIMMETRICI						
FUTS2730AM	2200 K	30°	3996 LM	3118 LM	FUTURA TESATA 27W 30° IP66 230V 2200K	418,00 €
FUTS2760AM	2200 K	60°	3996 LM	3074 LM	FUTURA TESATA 27W 60° IP66 230V 2200K	418,00 €
FUTS2790AM	2200 K	90°	3996 LM	3052 LM	FUTURA TESATA 27W 90° IP66 230V 2200K	418,00 €
FUTS2730C	3000 K	30°	4401 LM	3668 LM	FUTURA TESATA 27W 30° IP66 230V 3000K	418,00 €
FUTS2760C	3000 K	60°	4401 LM	3617 LM	FUTURA TESATA 27W 60° IP66 230V 3000K	418,00 €
FUTS2790C	3000 K	90°	4401 LM	3591 LM	FUTURA TESATA 27W 90° IP66 230V 3000K	418,00 €
FUTS2730N	4000 K	30°	4644 LM	3861 LM	FUTURA TESATA 27W 30° IP66 230V 4000K	418,00 €
FUTS2760N	4000 K	60°	4644 LM	3807 LM	FUTURA TESATA 27W 60° IP66 230V 4000K	418,00 €
FUTS2790N	4000 K	90°	4644 LM	3780 LM	FUTURA TESATA 27W 90° IP66 230V 4000K	418,00 €
ASIMMETRICI						
FUTS27TCOAM	2200 K	150°X75°	3996 LM	2965 LM	FUTURA TESATA 27W 150X75° IP66 230V 2200K	418,00 €
FUTS27T1SAM	2200 K	143°X50°	3996 LM	2922 LM	FUTURA TESATA 27W 143X50° IP66 230V 2200K	418,00 €
FUTS27T1MAM	2200 K	140°X60°	3996 LM	3031 LM	FUTURA TESATA 27W 140X60° IP66 230V 2200K	418,00 €
FUTS27T2AM	2200 K	151°X81°	3996 LM	2987 LM	FUTURA TESATA 27W 151X81° IP66 230V 2200K	418,00 €
FUTS27C50AM	2200 K	CON 50°	3996 LM	2943 LM	FUTURA TESATA 27W C50° IP66 230V 2200K	418,00 €
FUTS27D55AM	2200 K	DIFF 55°	3996 LM	2900 LM	FUTURA TESATA 27W D55° IP66 230V 2200K	418,00 €
FUTS27TCOC	3000 K	150°X75°	4401 LM	3488 LM	FUTURA TESATA 27W 143X50° IP66 230V 3000K	418,00 €
FUTS27T1SC	3000 K	143°X50°	4401 LM	3437 LM	FUTURA TESATA 27W 140X60° IP66 230V 3000K	418,00 €
FUTS27T1MC	3000 K	140°X60°	4401 LM	3565 LM	FUTURA TESATA 27W 151X81° IP66 230V 3000K	418,00 €
FUTS27T2C	3000 K	151°X81°	4401 LM	3514 LM	FUTURA TESATA 27W C50° IP66 230V 3000K	418,00 €
FUTS27C50C	3000 K	CON 50°	4401 LM	3463 LM	FUTURA TESATA 27W D55° IP66 230V 3000K	418,00 €
FUTS27D55C	3000 K	DIFF 55°	4401 LM	3411 LM	FUTURA TESATAE 27W D55° IP66 230V 3000K	418,00 €
FUTS27TCON	4000 K	150°X75°	4644 LM	3672 LM	FUTURA TESATA 27W 150X75° IP66 230V 4000K	418,00 €
FUTS27T1SN	4000 K	143°X50°	4644 LM	3618 LM	FUTURA TESATA 27W 143X50° IP66 230V 4000K	418,00 €
FUTS27T1MN	4000 K	140°X60°	4644 LM	3753 LM	FUTURA TESATA 27W 140X60° IP66 230V 4000K	418,00 €
FUTS27T2N	4000 K	151°X81°	4644 LM	3699 LM	FUTURA TESATA 27W 151X81° IP66 230V 4000K	418,00 €
FUTS27C50N	4000 K	CON 50°	4644 LM	3645 LM	FUTURA TESATA 27W C50° IP66 230V 4000K	418,00 €
FUTS27D55N	4000 K	DIFF 55°	4644 LM	3591 LM	FUTURA TESATA 27W D55° IP66 230V 4000K	418,00 €

FUTURA TS50

CODICE	TEMP.COL	ANG.	NOMIN	LUMEN USCENTI TE°=25	DESCRIZIONE METEL	LISTINO IVA ESCLUSA
SIMMETRICI						
FUTS5030AM	2200 K	30°	7400 LM	5774 LM	FUTURA TESATA 50W 30° IP66 230V 2200K	429,00 €
FUTS5060AM	2200 K	60°	7400 LM	5693 LM	FUTURA TESATA 50W 60° IP66 230V 2200K	429,00 €
FUTS5090AM	2200 K	90°	7400 LM	5653 LM	FUTURA TESATA 50W 90° IP66 230V 2200K	429,00 €
FUTS5030C	3000 K	30°	8150 LM	6793 LM	FUTURA TESATA 50W 30° IP66 230V 3000K	429,00 €
FUTS5060C	3000 K	60°	8150 LM	6698 LM	FUTURA TESATA 50W 60° IP66 230V 3000K	429,00 €
FUTS5090C	3000 K	90°	8150 LM	6650 LM	FUTURA TESATA 50W 90° IP66 230V 3000K	429,00 €
FUTS5030N	4000 K	30°	8600 LM	7150 LM	FUTURA TESATA 50W 30° IP66 230V 4000K	429,00 €
FUTS5060N	4000 K	60°	8600 LM	7050 LM	FUTURA TESATA 50W 60° IP66 230V 4000K	429,00 €
FUTS5090N	4000 K	90°	8600 LM	7000 LM	FUTURA TESATA 50W 90° IP66 230V 4000K	429,00 €
ASIMMETRICI						
FUTS50TCOAM	2200 K	150°X75°	7400 LM	5491 LM	FUTURA TESATA 50W 150X75° IP66 230V 2200K	429,00 €
FUTS50T1SAM	2200 K	143°X50°	7400 LM	5410 LM	FUTURA TESATA 50W 143X50° IP66 230V 2200K	429,00 €
FUTS50T1MAM	2200 K	140°X60°	7400 LM	5612 LM	FUTURA TESATA 50W 140X60° IP66 230V 2200K	429,00 €
FUTS50T2AM	2200 K	151°X81°	7400 LM	5531 LM	FUTURA TESATA 50W 151X81° IP66 230V 2200K	429,00 €
FUTS50C50AM	2200 K	CON 50°	7400 LM	5451 LM	FUTURA TESATA 50W C50° IP66 230V 2200K	429,00 €
FUTS50D55AM	2200 K	DIFF 55°	7400 LM	5370 LM	FUTURA TESATA 50W D55° IP66 230V 2200K	429,00 €
FUTS50TCOC	3000 K	150°X75°	8150 LM	6460 LM	FUTURA TESATA 50W 150X75° IP66 230V 3000K	429,00 €
FUTS50T1SC	3000 K	143°X50°	8150 LM	6365 LM	FUTURA TESATA 50W 143X50° IP66 230V 3000K	429,00 €
FUTS50T1MC	3000 K	140°X60°	8150 LM	6603 LM	FUTURA TESATA 50W 140X60° IP66 230V 3000K	429,00 €
FUTS50T2C	3000 K	151°X81°	8150 LM	6508 LM	FUTURA TESATA 50W 151X81° IP66 230V 3000K	429,00 €
FUTS50C50C	3000K	CON 50°	8150 LM	6413 LM	FUTURA TESATA 50W C50° IP66 230V 3000K	429,00 €
FUTS50D55C	3000K	DIFF 55°	8150 LM	6318 LM	FUTURA TESATA 50W D55° IP66 230V 3000K	429,00 €
FUTS50TCON	4000 K	150°X75°	8600 LM	6800 LM	FUTURA TESATA 50W 150X75° IP66 230V 4000K	429,00 €
FUTS50T1SN	4000 K	143°X50°	8600 LM	6700 LM	FUTURA TESATA 50W 143X50° IP66 230V 4000K	429,00 €
FUTS50T1MN	4000 K	140°X60°	8600 LM	6950 LM	FUTURA TESATA 50W 140X60° IP66 230V 4000K	429,00 €
FUTS50T2N	4000 K	151°X81°	8600 LM	6850 LM	FUTURA TESATA 50W 151X81° IP66 230V 4000K	429,00 €
FUTS50C50N	4000 K	CON 50°	8600 LM	6750 LM	FUTURA TESATA 50W C50° IP66 230V 4000K	429,00 €
FUTS50D55N	4000 K	DIFF 55°	8600 LM	6650 LM	FUTURA TESATA 50W D55° IP66 230V 4000K	429,00 €

CARATTERISTICHE GENERALI	
GRADO DI PROTEZIONE	IP66
IK	09
PESO	4500 G
CARATTERISTICHE ILLUMINAZIONE	
TIPO LED	3030
RESA CROMATICA	80
RG	01
MANTENIMENTO FLUSSO	90% 100000H (L90B10)
TOLLER. FLUSSO LUMINOSO	=+/- 7%
CARATTERISTICHE ELETTRICHE	
WATT	27W-50W-72W-108W
TOLLERANZA CONSUMO	=+/- 10%
SORGENTI LUMINOSE	96
ALIMENTAZIONE	230V

DIMMERABILE	A RICHIESTA
FATTORE DI POTENZA	0,95
INDICE DI MANUTENZIONE	0,95
MATERIALE FINITURE	
CORPO	ALLUMINIO PRESSOFUSO VERNICIATO A POLVERE
FINITURA	RAL9005
SCHERMO	VETRO TEMPERATO
CAVO	2X1.00 NEOPRENE
PRESSACAVO	NYLON
TEMPERATURE	
STOCCAGGIO	DA -35°C A +50°C
FUNZIONAMENTO	DA -35°C A +80°C
AFFIDABILITÀ	FINO A 7 ANNI DI GARANZIA
RICICLABILITÀ	95%

FUTURA TS72

CODICE	TEMP.COL	ANG.	NOMIN	LUMEN USCENTI TE°=25	DESCRIZIONE METEL	LISTINO IVA ESCLUSA
SIMMETRICI						
FUTS7230AM	2200 K	30°	10656 LM	8314 LM	FUTURA TESATA 72W 30° IP66 230V 2200K	441,00 €
FUTS7260AM	2200 K	60°	10656 LM	8198 LM	FUTURA TESATA 72W 60° IP66 230V 2200K	441,00 €
FUTS7290AM	2200 K	90°	10656 LM	8140 LM	FUTURA TESATA 72W 90° IP66 230V 2200K	441,00 €
FUTS7230C	3000 K	30°	11736 LM	9781 LM	FUTURA TESATA 72W 30° IP66 230V 3000K	441,00 €
FUTS7260C	3000 K	60°	11736 LM	9644 LM	FUTURA TESATA 72W 60° IP66 230V 3000K	441,00 €
FUTS7290C	3000 K	90°	11736 LM	9576 LM	FUTURA TESATA 72W 90° IP66 230V 3000K	441,00 €
FUTS7230N	4000 K	30°	12384 LM	10296 LM	FUTURA TESATA 72W 30° IP66 230V 4000K	441,00 €
FUTS7260N	4000 K	60°	12384 LM	10152 LM	FUTURA TESATA 72W 60° IP66 230V 4000K	441,00 €
FUTS7290N	4000 K	90°	12384 LM	10080 LM	FUTURA TESATA 72W 90° IP66 230V 4000K	441,00 €
ASIMMETRICI						
FUTS72TCOAM	2200 K	150°X75°	10656 LM	7907 LM	FUTURA TESATA 72W 150X75° IP66 230V 2200K	441,00 €
FUTS72T1SAM	2200 K	143°X50°	10656 LM	7791 LM	FUTURA TESATA 72W 143X50° IP66 230V 2200K	441,00 €
FUTS72T1MAM	2200 K	140°X60°	10656 LM	8081 LM	FUTURA TESATA 72W 140X60° IP66 230V 2200K	441,00 €
FUTS72T2AM	2200 K	151°X81°	10656 LM	7965 LM	FUTURA TESATA 72W 151X81° IP66 230V 2200K	441,00 €
FUTS72C50AM	2200 K	CON 50°	10656 LM	7849 LM	FUTURA TESATA 72W C50° IP66 230V 2200K	441,00 €
FUTS72D55AM	2200 K	DIFF 55°	10656 LM	7733 LM	FUTURA TESATA 72W D55° IP66 230V 2200K	441,00 €
FUTS72TCOC	3000 K	150°X75°	11736 LM	9302 LM	FUTURA TESATA 72W 150X75° IP66 230V 3000K	441,00 €
FUTS72T1SC	3000 K	143°X50°	11736 LM	9166 LM	FUTURA TESATA 72W 143X50° IP66 230V 3000K	441,00 €
FUTS72T1MC	3000 K	140°X60°	11736 LM	9508 LM	FUTURA TESATA 72W 140X60° IP66 230V 3000K	441,00 €
FUTS72T2C	3000K	151°X81°	11736 LM	9371 LM	FUTURA TESATA 72W 151X81° IP66 230V 3000K	441,00 €
FUTS72C50C	3000 K	CON 50°	11736 LM	9234 LM	FUTURA TESATA 72W C50° IP66 230V 3000K	441,00 €
FUTS72D55C	3000 K	DIFF 55°	11736 LM	9097 LM	FUTURA TESATA 72W D55° IP66 230V 3000K	441,00 €
FUTS72TCON	4000 K	150°X75°	12384 LM	9792 LM	FUTURA TESATA 72W 150X75° IP66 230V 4000K	441,00 €
FUTS72T1SN	4000 K	143°X50°	12384 LM	9648 LM	FUTURA TESATA 72W 143X50° IP66 230V 4000K	441,00 €
FUTS72T1MN	4000 K	140°X60°	12384 LM	10008 LM	FUTURA TESATA 72W 140X60° IP66 230V 4000K	441,00 €
FUTS72T2N	4000 K	151°X81°	12384 LM	9864 LM	FUTURA TESATA 72W 151X81° IP66 230V 4000K	441,00 €
FUTS72C50N	4000 K	CON 50°	12384 LM	9720 LM	FUTURA TESATA 72W C50° IP66 230V 4000K	441,00 €
FUTS72D55N	4000 K	DIFF 55°	12384 LM	9576 LM	FUTURA TESATA 72W D55° IP66 230V 4000K	441,00 €

FUTURA TP108

CODICE	TEMP.COL	ANG.	NOMIN	LUMEN USCENTI TE°=25	DESCRIZIONE METEL	LISTINO IVA ESCLUSA
SIMMETRICI						
FUTS10830AM	2200 K	30°	15984 LM	12471 LM	FUTURA TESATA 108W 30° IP66 230V 2200K	453,00 €
FUTS10860AM	2200 K	60°	15984 LM	12297 LM	FUTURA TESATA 108W 60° IP66 230V 2200K	453,00 €
FUTS10890AM	2200 K	90°	15984 LM	12209 LM	FUTURA TESATA 108W 90° IP66 230V 2200K	453,00 €
FUTS10830C	3000 K	30°	17604 LM	14672 LM	FUTURA TESATA 108W 30° IP66 230V 3000K	453,00 €
FUTS10860C	3000 K	60°	17604 LM	14467 LM	FUTURA TESATA 108W 60° IP66 230V 3000K	453,00 €
FUTS10890C	3000 K	90°	17604 LM	14364 LM	FUTURA TESATA 108W 90° IP66 230V 3000K	453,00 €
FUTS10830N	4000 K	30°	18576 LM	15444 LM	FUTURA TESATA 108W 30° IP66 230V 4000K	453,00 €
FUTS10860N	4000 K	60°	18576 LM	15228 LM	FUTURA TESATA 108W 60° IP66 230V 4000K	453,00 €
FUTS10890N	4000 K	90°	18576 LM	15120 LM	FUTURA TESATA 108W 90° IP66 230V 4000K	453,00 €
ASIMMETRICI						
FUTS108TCOAM	2200 K	150°X75°	15984 LM	11861 LM	FUTURA TESATA 108W 150X75° IP66 230V 2200K	453,00 €
FUTS108T1SAM	2200 K	143°X50°	15984 LM	11686 LM	FUTURA TESATA 108W 143X50° IP66 230V 2200K	453,00 €
FUTS108T1MAM	2200 K	140°X60°	15984 LM	12122 LM	FUTURA TESATA 108W 140X60° IP66 230V 2200K	453,00 €
FUTS108T2AM	2200 K	151°X81°	15984 LM	11948 LM	FUTURA TESATA 108W 151X81° IP66 230V 2200K	453,00 €
FUTS108C50AM	2200 K	CON 50°	15984 LM	11773 LM	FUTURA TESATA 108W C50° IP66 230V 2200K	453,00 €
FUTS108D55AM	2200 K	DIFF 55°	15984 LM	11599 LM	FUTURA TESATA 108W D55° IP66 230V 2200K	453,00 €
FUTS108TCOC	3000 K	150°X75°	17604 LM	13954 LM	FUTURA TESATA 108W 150X75° IP66 230V 3000K	453,00 €
FUTS108T1SC	3000 K	143°X50°	17604 LM	13748 LM	FUTURA TESATA 108W 143X50° IP66 230V 3000K	453,00 €
FUTS108T1MC	3000 K	140°X60°	17604 LM	14261 LM	FUTURA TESATA 108W 140X60° IP66 230V 3000K	453,00 €
FUTS108T2C	3000 K	151°X81°	17604 LM	14056 LM	FUTURA TESATA 108W 151X81° IP66 230V 3000K	453,00 €
FUTS108C50C	3000 K	CON 50°	17604 LM	13851 LM	FUTURA TESATA 108W C50° IP66 230V 3000K	453,00 €
FUTS108D55C	3000 K	DIFF 55°	17604 LM	13646 LM	FUTURA TESATA 108W D55° IP66 230V 3000K	453,00 €
FUTS108TCON	4000 K	150°X75°	18576 LM	14688 LM	FUTURA TESATA 108W 150X75° IP66 230V 4000K	453,00 €
FUTS108T1SN	4000 K	143°X50°	18576 LM	14472 LM	FUTURA TESATA 108W 143X50° IP66 230V 4000K	453,00 €
FUTS108T1MN	4000 K	140°X60°	18576 LM	15012 LM	FUTURA TESATA 108W 140X60° IP66 230V 4000K	453,00 €
FUTS108T2N	4000 K	151°X81°	18576 LM	14796 LM	FUTURA TESATA 108W 151X81° IP66 230V 4000K	453,00 €
FUTS108C50N	4000 K	CON 50°	18576 LM	14580 LM	FUTURA TESATA 108W C50° IP66 230V 4000K	453,00 €
FUTS108D55N	4000 K	DIFF 55°	18576 LM	14364 LM	FUTURA TESATA 108W D55° IP66 230V 4000K	453,00 €



 **PLAYLED**

PLAYLED È UN BRAND DI **INGEGNERIE MECCANICHE ITALIANE S.R.L.**

COSTRUTTORI ITALIANI DI PRODOTTI PER ILLUMINARE